

Signal Processing Toolbox™

Reference

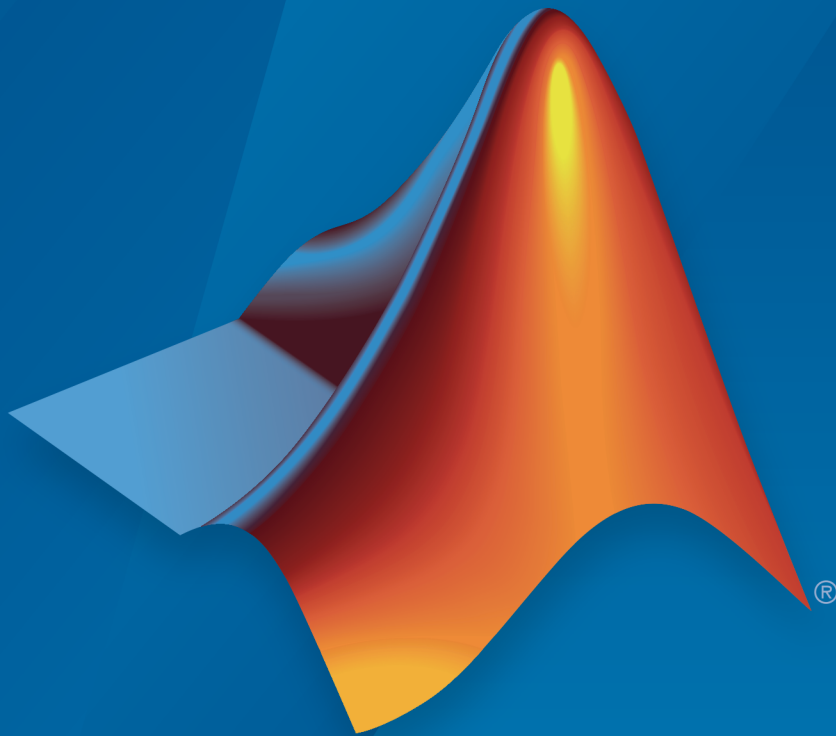

MATLAB®

R2017a



How to Contact MathWorks



Latest news: www.mathworks.com
Sales and services: www.mathworks.com/sales_and_services
User community: www.mathworks.com/matlabcentral
Technical support: www.mathworks.com/support/contact_us



Phone: 508-647-7000



The MathWorks, Inc.
3 Apple Hill Drive
Natick, MA 01760-2098

Signal Processing Toolbox™ Reference

© COPYRIGHT 1988–2017 by The MathWorks, Inc.

The software described in this document is furnished under a license agreement. The software may be used or copied only under the terms of the license agreement. No part of this manual may be photocopied or reproduced in any form without prior written consent from The MathWorks, Inc.

FEDERAL ACQUISITION: This provision applies to all acquisitions of the Program and Documentation by, for, or through the federal government of the United States. By accepting delivery of the Program or Documentation, the government hereby agrees that this software or documentation qualifies as commercial computer software or commercial computer software documentation as such terms are used or defined in FAR 12.212, DFARS Part 227.72, and DFARS 252.227-7014. Accordingly, the terms and conditions of this Agreement and only those rights specified in this Agreement, shall pertain to and govern the use, modification, reproduction, release, performance, display, and disclosure of the Program and Documentation by the federal government (or other entity acquiring for or through the federal government) and shall supersede any conflicting contractual terms or conditions. If this License fails to meet the government's needs or is inconsistent in any respect with federal procurement law, the government agrees to return the Program and Documentation, unused, to The MathWorks, Inc.

Trademarks

MATLAB and Simulink are registered trademarks of The MathWorks, Inc. See www.mathworks.com/trademarks for a list of additional trademarks. Other product or brand names may be trademarks or registered trademarks of their respective holders.

Patents

MathWorks products are protected by one or more U.S. patents. Please see www.mathworks.com/patents for more information.

Revision History

1988	First printing	New
November 1997	Second printing	Revised
January 1998	Third printing	Revised
September 2000	Fourth printing	Revised for Version 5.0 (Release 12)
July 2002	Fifth printing	Revised for Version 6.0 (Release 13)
December 2002	Online only	Revised for Version 6.1 (Release 13+)
June 2004	Online only	Revised for Version 6.2 (Release 14)
October 2004	Online only	Revised for Version 6.2.1 (Release 14SP1)
March 2005	Online only	Revised for Version 6.2.1 (Release 14SP2)
September 2005	Online only	Revised for Version 6.4 (Release 14SP3)
March 2006	Sixth printing	Revised for Version 6.5 (Release 2006a)
September 2006	Online only	Revised for Version 6.6 (Release 2006b)
March 2007	Online only	Revised for Version 6.7 (Release 2007a)
September 2007	Online only	Revised for Version 6.8 (Release 2007b)
March 2008	Online only	Revised for Version 6.9 (Release 2008a)
October 2008	Online only	Revised for Version 6.10 (Release 2008b)
March 2009	Online only	Revised for Version 6.11 (Release 2009a)
September 2009	Online only	Revised for Version 6.12 (Release 2009b)
March 2010	Online only	Revised for Version 6.13 (Release 2010a)
September 2010	Online only	Revised for Version 6.14 (Release 2010b)
April 2011	Online only	Revised for Version 6.15 (Release 2011a)
September 2011	Online only	Revised for Version 6.16 (Release 2011b)
March 2012	Online only	Revised for Version 6.17 (Release 2012a)
September 2012	Online only	Revised for Version 6.18 (Release 2012b)
March 2013	Online only	Revised for Version 6.19 (Release 2013a)
September 2013	Online only	Revised for Version 6.20 (Release 2013b)
March 2014	Online only	Revised for Version 6.21 (Release 2014a)
October 2014	Online only	Revised for Version 6.22 (Release 2014b)
March 2015	Online only	Revised for Version 7.0 (Release 2015a)
September 2015	Online only	Revised for Version 7.1 (Release 2015b)
March 2016	Online only	Revised for Version 7.2 (Release 2016a)
September 2016	Online only	Revised for Version 7.3 (Release 2016b)
March 2017	Online only	Revised for Version 7.4 (Release 2017a)

1	Functions — Alphabetical List
----------	--------------------------------------

Functions — Alphabetical List

abs

Absolute value (magnitude)

Description

abs is a MATLAB® function.

Examples

Magnitude of the DFT of a Sequence

Generate a signal composed of two sinusoids sampled at 100 Hz. Specify the sinusoid frequencies as 15 and 40 Hz. Compute the DFT of the sequence.

```
t = (0:99)/100;           % Time vector
x = sin(2*pi*15*t) + sin(2*pi*40*t); % Signal
y = fft(x);              % DFT of x
m = abs(y);              % Magnitude
```

Plot the magnitude of the DFT.

```
f = 0:50;                % Frequency vector
m = m(1:51);            % Unique magnitudes
stem(f,m)
ylabel 'DFT magnitude'
xlabel 'Frequency (Hz)'
```

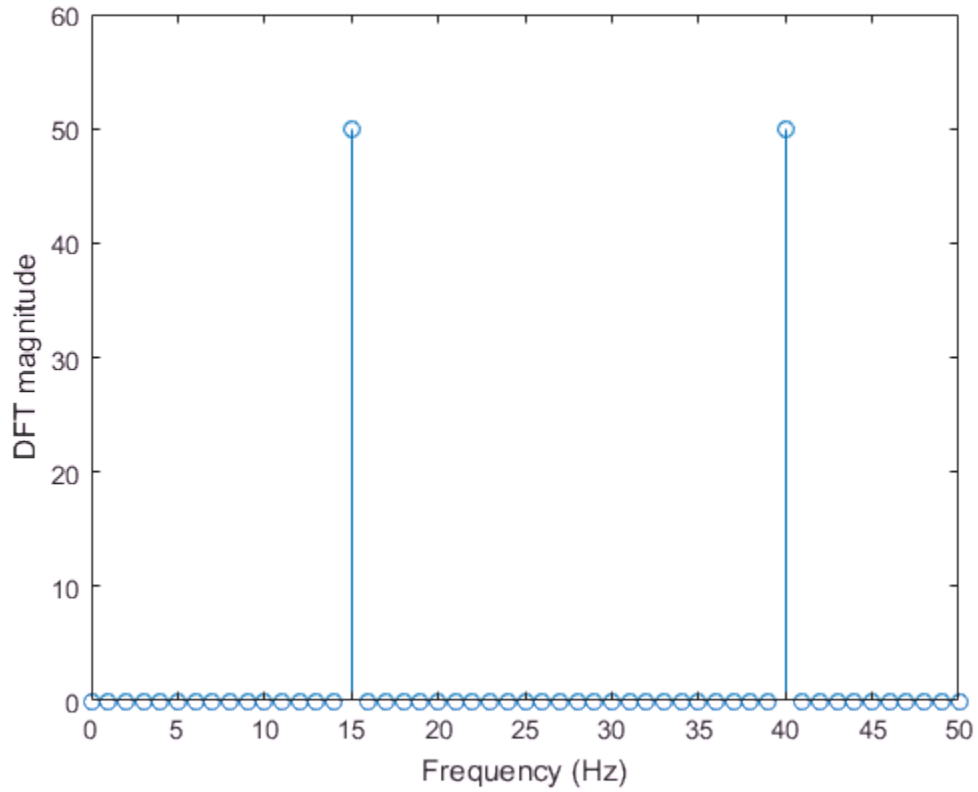
Introduced before R2006a

ac2poly

Convert autocorrelation sequence to prediction polynomial

Syntax

```
a = ac2poly(r)
[a,efinal] = ac2poly(r)
```

Description

`a = ac2poly(r)` finds the linear prediction FIR filter polynomial, `a`, corresponding to the autocorrelation sequence `r`. `a` is the same length as `r`, and `a(1) = 1`. The polynomial represents the coefficients of a prediction filter that outputs a signal with autocorrelation sequence approximately equal to `r`.

`[a,efinal] = ac2poly(r)` returns the final prediction error, `efinal`, determined by running the filter for `length(r)` steps.

Examples

Prediction Polynomial from Autocorrelation Sequence

Given an autocorrelation sequence, `r`, determine the equivalent linear prediction filter polynomial and the final prediction error.

```
r = [5.0000 -1.5450 -3.9547 3.9331 1.4681 -4.7500];
```

```
[a,efinal] = ac2poly(r)
```

```
a =
```

```
    1.0000    0.6147    0.9898    0.0004    0.0034   -0.0077
```

```
efinal = 0.1791
```

Tips

You can apply this function to real or complex data.

References

[1] Kay, Steven M. *Modern Spectral Estimation*. Englewood Cliffs, NJ: Prentice-Hall, 1988.

See Also

ac2rc | poly2ac | rc2poly

Introduced before R2006a

ac2rc

Convert autocorrelation sequence to reflection coefficients

Syntax

```
[k,r0] = ac2rc(r)
```

Description

`[k,r0] = ac2rc(r)` finds the reflection coefficients, `k`, corresponding to the autocorrelation sequence `r`. `r0` contains the zero-lag autocorrelation. If `r` is a matrix where the columns are separate channels of autocorrelation sequences, `r0` contains the zero-lag autocorrelation coefficient for each channel. These reflection coefficients can be used to specify the lattice prediction filter that produces a sequence with approximately the same autocorrelation sequence as the given sequence `r`.

Tips

You can apply this function to real or complex data.

References

[1] Kay, Steven M. *Modern Spectral Estimation*. Englewood Cliffs, NJ: Prentice-Hall, 1988.

See Also

`ac2poly` | `rc2ac` | `poly2rc`

Introduced before R2006a

alignsignals

Align two signals by delaying earliest signal

Syntax

```
[Xa,Ya] = alignsignals(X,Y)
[Xa,Ya] = alignsignals(X,Y,maxlag)
[Xa,Ya] = alignsignals(X,Y,maxlag,'truncate')
[Xa,Ya,D] = alignsignals( ___ )
```

Description

`[Xa,Ya] = alignsignals(X,Y)` estimates the delay, D , between the two input signals, X and Y , and returns the aligned signals, Xa and Ya .

- If Y is delayed with respect to X , then D is positive and X is delayed by D samples.
- If Y is advanced with respect to X , then D is negative and Y is delayed by $-D$ samples.

Delays in X or Y can be introduced by prepending zeros.

`[Xa,Ya] = alignsignals(X,Y,maxlag)` uses `maxlag` as the maximum window size to find the estimated delay, D , between the two input signals, X and Y . It returns the aligned signals, Xa and Ya .

`[Xa,Ya] = alignsignals(X,Y,maxlag,'truncate')` keeps the lengths of the aligned signals, Xa and Ya , the same as those of the input signals, X and Y , respectively.

- If the estimated delay, D , is positive, then D zeros are prepended to X and the last D samples of X are truncated.
- If the estimated delay, D , is negative, then $-D$ zeros are prepended to Y and the last $-D$ samples of Y are truncated.

Notes X and Y are row or column vectors of length L_X and L_Y , respectively.

- If $D \geq L_X$, then Xa consists of L_X zeros. All samples of X are lost.
 - If $-D \geq L_Y$, then Ya consists of L_Y zeros. All samples of Y are lost.
-

To avoid assigning a specific value to `maxlag` when using the `'truncate'` option, set `maxlag` to `[]`.

`[Xa,Ya,D] = alignsignals(___)` returns the estimated delay, `D`. This syntax can include any of the input arguments used in previous syntaxes.

Examples

Align Two Signals Where the First Signal Lags by Three Samples

Align signal `Y` with respect to `X` by advancing it three samples.

Create two signals, `X` and `Y`. `X` is exactly the same as `Y`, except `X` has three leading zeros and one additional following zero. Align the two signals.

```
X = [0 0 0 1 2 3 0 0];  
Y = [1 2 3 0];
```

```
[Xa,Ya] = alignsignals(X,Y)
```

```
Xa =
```

```
    0    0    0    1    2    3    0    0
```

```
Ya =
```

```
    0    0    0    1    2    3    0
```

Align Two Signals Where the Second Signal Lags by Two Samples

Align signal `X` when `Y` is delayed with respect to `X` by two samples.

Create two signals, `X` and `Y`. `Y` is exactly the same as `X`, except `Y` has two leading zeros. Align the two signals.

```
X = [1 2 3];  
Y = [0 0 1 2 3];  
maxlag = 2;
```

```
[Xa,Ya,D] = alignsignals(X,Y,maxlag)
```

```
Xa =  
    0    0    1    2    3  
  
Ya =  
    0    0    1    2    3  
  
D = 2
```

Align Two Signals Where the Second Signal Is Noisy

Align signal Y with respect to X, despite the fact that Y is a noisy signal.

Create two signals, X and Y. Y is exactly the same as X with some noise added to it. Align the two signals.

```
X = [0 0 1 2 3 0];  
Y = [0.02 0.12 1.08 2.21 2.95 -0.09];  
  
[Xa,Ya,D] = alignsignals(X,Y)  
  
Xa =  
    0    0    1    2    3    0  
  
Ya =  
    0.0200    0.1200    1.0800    2.2100    2.9500   -0.0900  
  
D = 0
```

You do not need to change the input signals to produce the output signals. The delay D is zero.

Align Two Signals Using the 'truncate' Option

Invoke the 'truncate' option when calling the alignsignals function.

Create two signals, X and Y. Y is exactly the same as X, except Y has two leading zeros. Align the two signals, applying the 'truncate' directive.

```
X = [1 2 3];  
Y = [0 0 1 2 3];  
  
[Xa,Ya,D] = alignsignals(X,Y,[],'truncate')
```

```
Xa =
```

```
    0    0    1
```

```
Ya =
```

```
    0    0    1    2    3
```

```
D = 2
```

Observe that the output signal `Xa` has a length of 3, the same length as input signal `X`.

In the case where using the `'truncate'` option ends up truncating all the original data of `X`, a warning is issued. To make `alignsignals` issue such a warning, run the following example.

```
Y = [0 0 0 0 1 2 3];  
  
[Xa,Ya,D] = alignsignals(X,Y,[],'truncate')
```

```
Warning: All original data in the first input X has been truncated because the length of
```

```
Xa =
```

```
    0    0    0
```

```
Ya =
```

```
    0    0    0    0    1    2    3
```

```
D = 4
```

Align a Signal and a Periodic Repetition of It

Align signal `Y` with respect to `X`, despite the fact that `Y` is a periodic repetition of `X`. Return the smallest possible delay.

Create two signals, X and Y. Y consists of two copies of the nonzero portion of X separated by zeros. Align the two signals.

```
X = [0 1 2 3];
Y = [1 2 3 0 0 0 0 1 2 3 0 0];
```

```
[Xa,Ya,D] = alignsignals(X,Y)
```

```
Xa =
```

```
    0    1    2    3
```

```
Ya =
```

```
    0    1    2    3    0    0    0    0    1    2    3    0    0
```

```
D = -1
```

Input Arguments

X — First input signal

vector of numeric values

First input signal, specified as a numeric vector of length LX .

Example: [1 2 3]

Data Types: single | double | int8 | int16 | int32 | int64 | uint8 | uint16 | uint32 | uint64

Complex Number Support: Yes

Y — Second input signal

vector of numeric values

Second input signal, specified as a numeric vector of length LY .

Example: [0 0 1 2 3]

Data Types: single | double | int8 | int16 | int32 | int64 | uint8 | uint16 | uint32 | uint64

Complex Number Support: Yes

maxlag — Maximum window size or lag

scalar integer | []

Maximum window size, or lag, specified as an integer-valued scalar. By default, `maxlag` is equal to `max(length(X), length(Y)) - 1`. If `maxlag` is input as [], it is replaced by the default value. If `maxlag` is negative, it is replaced by its absolute value. If `maxlag` is not integer-valued, or is complex, `Inf`, or `NaN`, then `alignsignals` returns an error.

Example: 2

Data Types: single | double | int8 | int16 | int32 | int64 | uint8 | uint16 | uint32 | uint64

Output Arguments

Xa — Aligned first signal

vector of numeric values

Aligned first signal, returned as a numeric vector that is aligned with the second output argument, `Ya`. If input argument `X` is a row vector, then `Xa` is also a row vector. If input argument `X` is a column vector, then `Xa` is also a column vector. If you specify the 'truncate' option and the estimated delay D is positive, then `Xa` is equivalent to the input signal `X` with D zeros prepended to it and its last D samples truncated.

Ya — Aligned second signal

vector of numeric values

Aligned second signal, returned as a numeric vector that is aligned with the first output argument, `Xa`. If input argument `Y` is a row vector, then `Ya` is also a row vector. If input argument `Y` is a column vector, then `Ya` is also a column vector. If you specify the 'truncate' option and the estimated delay D is negative, then `Ya` is equivalent to the input signal `Y` with $-D$ zeros prepended to it and its last $-D$ samples truncated.

D — Estimated delay between input signals

scalar integer

Estimated delay between input signals, returned as a scalar integer. This integer represents the number of samples by which the two input signals, `X` and `Y` are offset.

- If `Y` is delayed with respect to `X`, then `D` is positive and `X` is delayed by `D` samples.
- If `Y` is advanced with respect to `X`, then `D` is negative and `Y` is delayed by $-D$ samples.

- If X and Y are already aligned, then D is zero and neither X nor Y are delayed.

If you specify a value for the input argument `maxlag`, then D must be less than or equal to `maxlag`.

Algorithms

- You can find the theory on delay estimation in the specification of the `finddelay` function (see “Algorithms” on page 1-823).
- The `alignsignals` function uses the estimated delay D to delay the earliest signal such that the two signals have the same starting point.
- As specified for the `finddelay` function, the pair of signals need not be exact delayed copies of each other. However, the signals can be successfully aligned only if there is sufficient correlation between them.

For more information on estimating covariance and correlation functions, see [1].

References

- [1] Orfanidis, Sophocles J. *Optimum Signal Processing. An Introduction*. 2nd Ed. Englewood Cliffs, NJ: Prentice-Hall, 1996.

Extended Capabilities

C/C++ Code Generation

Generate C and C++ code using MATLAB® Coder™.

See Also

See Also

`dtw` | `edr` | `finddelay` | `findsignal` | `xcorr`

angle

Phase angle

Description

`angle` is a MATLAB function.

Examples

Magnitude and Phase of Complex Number

Create an arbitrary complex number. Compute its magnitude and phase.

```
z = 42*exp(1j*0.1234)
```

```
z =  
 41.6806 + 5.1697i
```

```
mag = abs(z)
```

```
mag = 42
```

```
phs = angle(z)
```

```
phs = 0.1234
```

FFT Phase

Generate a signal that consists of two sinusoids of frequencies 15 Hz and 40 Hz. The signal is sampled at 100 Hz for one second.

```
fs = 100;  
t = 0:1/fs:1-1/fs;  
x = sin(2*pi*15*t) + sin(2*pi*40*t);
```

Compute the discrete Fourier transform of the signal. Plot the magnitude of the transform as a function of frequency.

```
y = fft(x);  
  
ly = length(y);  
f = (-ly/2:ly/2-1)/ly*fs;  
  
stem(f,abs(fftshift(y)))  
xlabel 'Frequency (Hz)'  
ylabel '|y|'
```

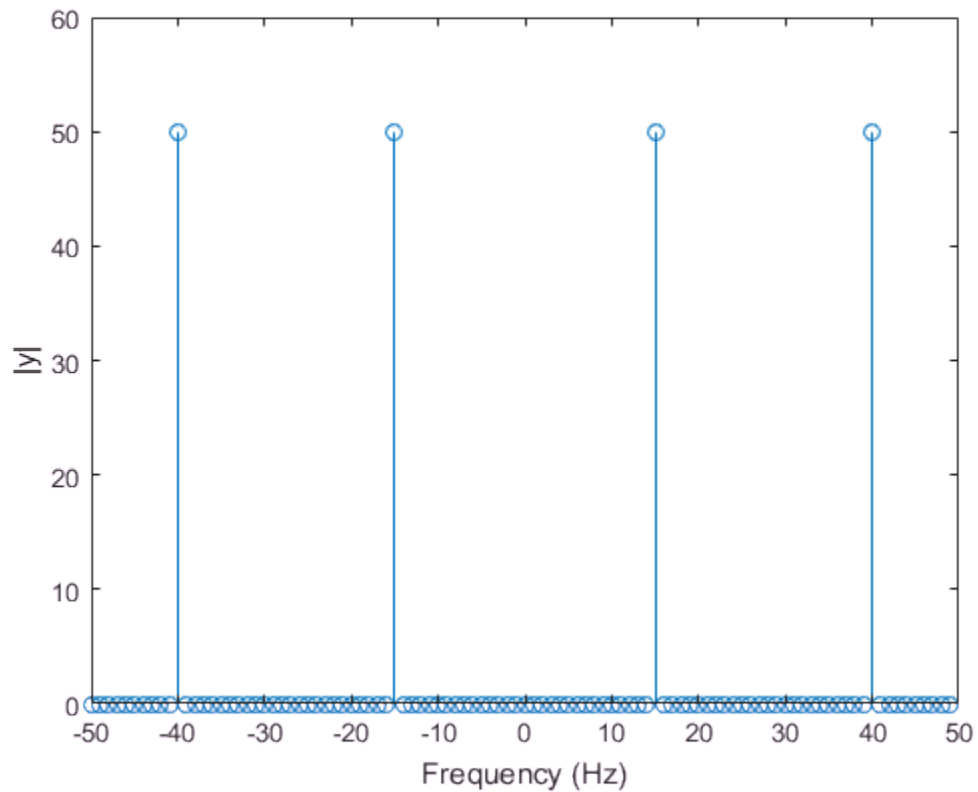

Find the phase of the transform and plot it as a function of frequency.

```
phs = angle(fftshift(y));  
  
plot(f,phs/pi)
```

```
xlabel 'Frequency (Hz)'  
ylabel 'Phase / \pi'  
grid
```

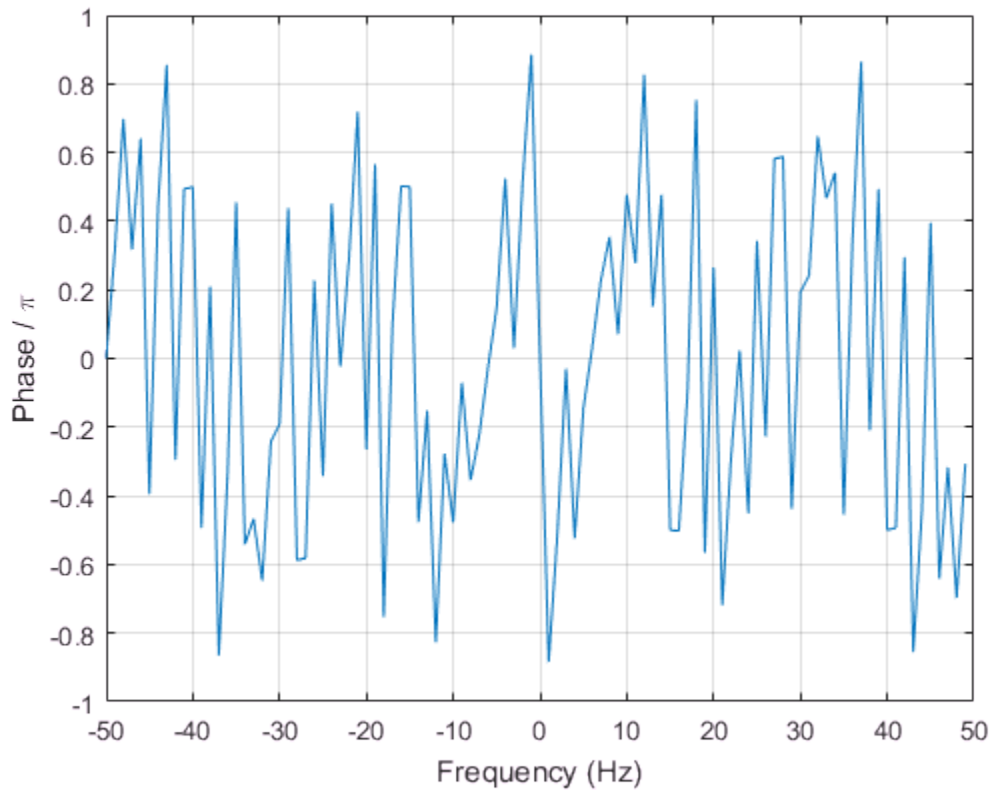

See Also

See Also

abs | fft | unwrap

Introduced before R2006a

arburg

Autoregressive all-pole model parameters — Burg's method

Syntax

```
a = arburg(x,p)
[a,e] = arburg(x,p)
[a,e,rc] = arburg(x,p)
```

Description

`a = arburg(x,p)` returns the normalized autoregressive (AR) parameters corresponding to a model of order `p` for the input array, `x`. If `x` is a vector, then the output array, `a`, is a row vector. If `x` is a matrix, then the parameters along the n th row of `a` model the n th column of `x`. `a` has `p + 1` columns. `p` must be less than the number of elements (or rows) of `x`.

`[a,e] = arburg(x,p)` returns the estimated variance, `e`, of the white noise input.

`[a,e,rc] = arburg(x,p)` returns the reflection coefficients in `rc`.

Examples

Parameter Estimation Using Burg's Method

Use a vector of polynomial coefficients to generate an AR(4) process by filtering 1024 samples of white noise. Reset the random number generator for reproducible results. Use Burg's method to estimate the coefficients.

```
rng default
A = [1 -2.7607 3.8106 -2.6535 0.9238];
y = filter(1,A,0.2*randn(1024,1));
```

```
arcoeffs = arburg(y,4)

arcoeffs =

    1.0000   -2.7743    3.8408   -2.6843    0.9360
```

Generate 50 realizations of the process, changing each time the variance of the input noise. Compare the Burg-estimated variances to the actual values.

```
nrealiz = 50;

noisestdz = rand(1,nrealiz)+0.5;

randnoise = randn(1024,nrealiz);

for k = 1:nrealiz
    y = filter(1,A,noisestdz(k) * randnoise(:,k));
    [arcoeffs,noisevar(k)] = arburg(y,4);
end

plot(noisestdz.^2,noisevar,'*')
title('Noise Variance')
xlabel('Input')
ylabel('Estimated')
```

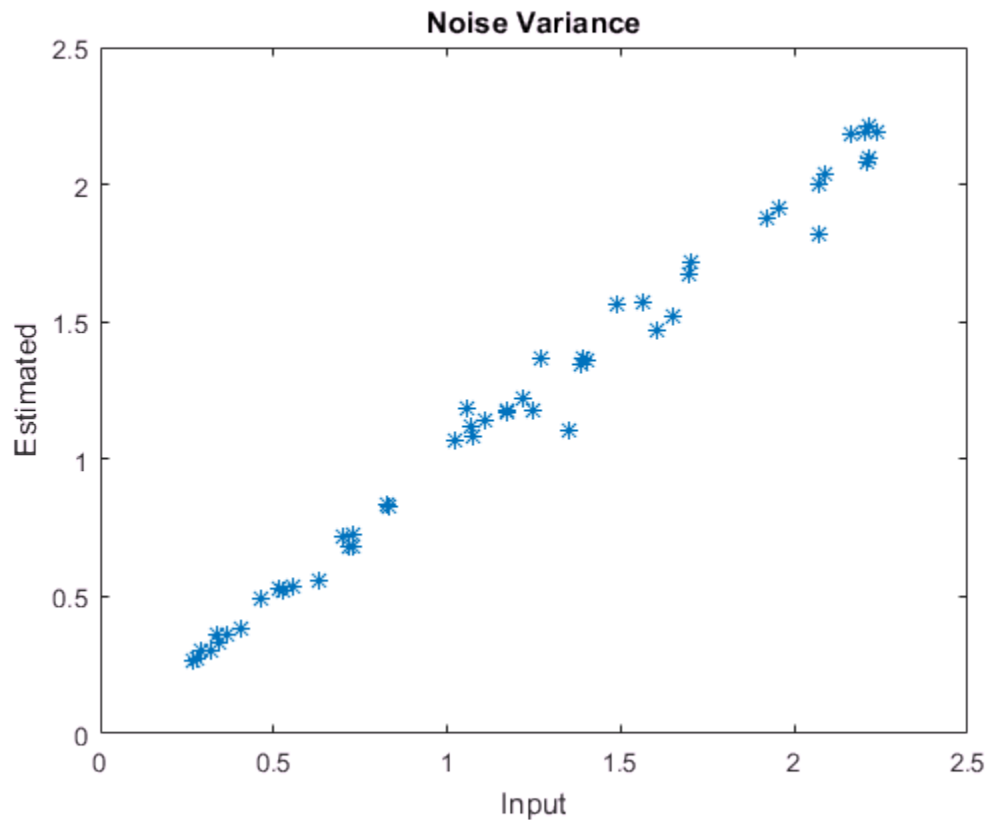
Repeat the procedure using arburg's multichannel syntax.

```
realiz = bsxfun(@times,noisestdz,randnoise);  
Y = filter(1,A,realiz);  
[coeffs,variances] = arburg(Y,4);  
hold on  
plot(noisestdz.^2,variances,'o')  
q = legend('Single channel loop','Multichannel');  
q.Location = 'best';
```

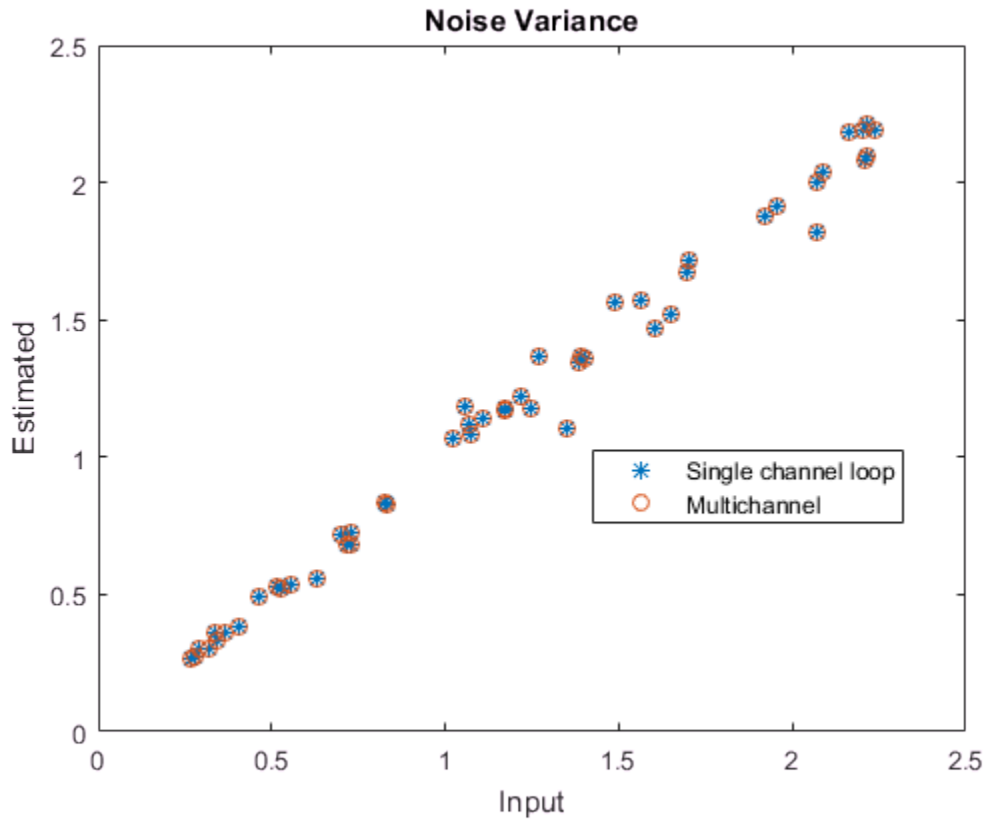

Definitions

AR(p) Model

In an AR model of order p , the current output is a linear combination of the past p outputs plus a white noise input. The weights on the p past outputs minimize the mean-square prediction error of the autoregression. If $y(n)$ is the current value of the output and $x(n)$ is a zero mean white noise input, the AR(p) model is:

$$y(n) + \sum_{k=1}^p \alpha(k)y(n-k) = x(n).$$

Reflection Coefficients

The *reflection coefficients* are the partial autocorrelation coefficients scaled by -1 . The reflection coefficients indicate the time dependence between $y(n)$ and $y(n-k)$ after subtracting the prediction based on the intervening $k-1$ time steps.

Algorithms

The Burg method estimates the reflection coefficients and uses the reflection coefficients to estimate the AR parameters recursively. You can find the recursion and lattice filter relations describing the update of the forward and backward prediction errors in [1].

References

[1] Kay, Steven M. *Modern Spectral Estimation: Theory and Application*. Englewood Cliffs, NJ: Prentice Hall, 1988.

See Also

arcov | armcov | aryule | levinson | lpc

Topics

“Parametric Modeling”

Introduced before R2006a

arconv

Autoregressive all-pole model parameters — covariance method

Syntax

```
a = arconv(x,p)
[a,e] = arconv(x,p)
```

Description

`a = arconv(x,p)` uses the covariance method to fit a p th-order autoregressive (AR) model to the input signal, x , which is assumed to be the output of an AR system driven by white noise. This method minimizes the forward prediction error in the least-squares sense. The output array, \mathbf{a} , contains normalized estimates of the AR system parameters, $A(z)$, in descending powers of z . \mathbf{a} has $p + 1$ columns. If x is a vector, then \mathbf{a} is a row vector. If \mathbf{a} is a matrix, then the coefficients along the n th row of \mathbf{a} model the n th column of x .

`[a,e] = arconv(x,p)` returns the variance estimate, e , of the white noise input to the AR model.

Examples

Parameter Estimation Using the Covariance Method

Use a vector of polynomial coefficients to generate an AR(4) process by filtering 1024 samples of white noise. Reset the random number generator for reproducible results. Use the covariance method to estimate the coefficients.

```
rng default
A = [1 -2.7607 3.8106 -2.6535 0.9238];
y = filter(1,A,0.2*randn(1024,1));
```

```
arcoeffs = arccov(y,4)

arcoeffs =

    1.0000    -2.7746    3.8419   -2.6857    0.9367
```

Generate 50 realizations of the process, changing each time the variance of the input noise. Compare the covariance-estimated variances to the actual values.

```
nrealiz = 50;

noisestdz = rand(1,nrealiz)+0.5;

randnoise = randn(1024,nrealiz);

for k = 1:nrealiz
    y = filter(1,A,noisestdz(k) * randnoise(:,k));
    [arcoeffs,noisevar(k)] = arccov(y,4);
end

plot(noisestdz.^2,noisevar,'*')
title('Noise Variance')
xlabel('Input')
ylabel('Estimated')
```

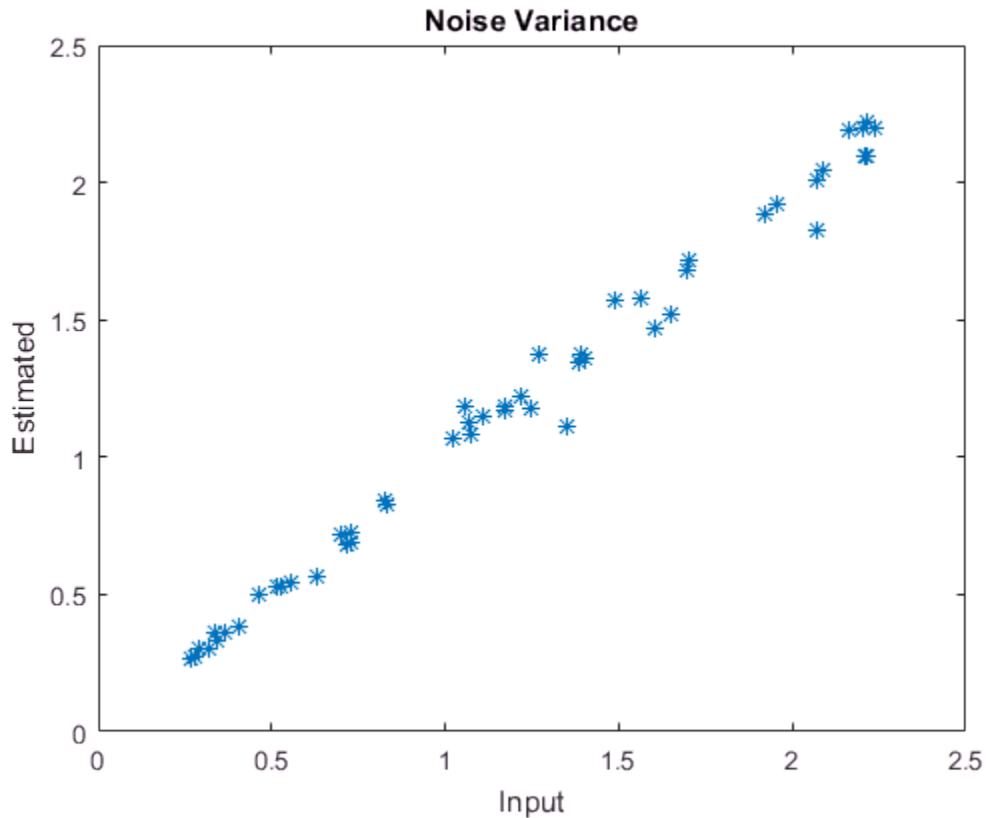

Repeat the procedure using `arccov`'s multichannel syntax.

```

realiz = bsxfun(@times,noisestdz,randnoise);
Y = filter(1,A,realiz);
[coeffs,variances] = arccov(Y,4);

hold on
plot(noisestdz.^2,variances,'o')

q = legend('Single channel loop','Multichannel');
q.Location = 'best';
    
```

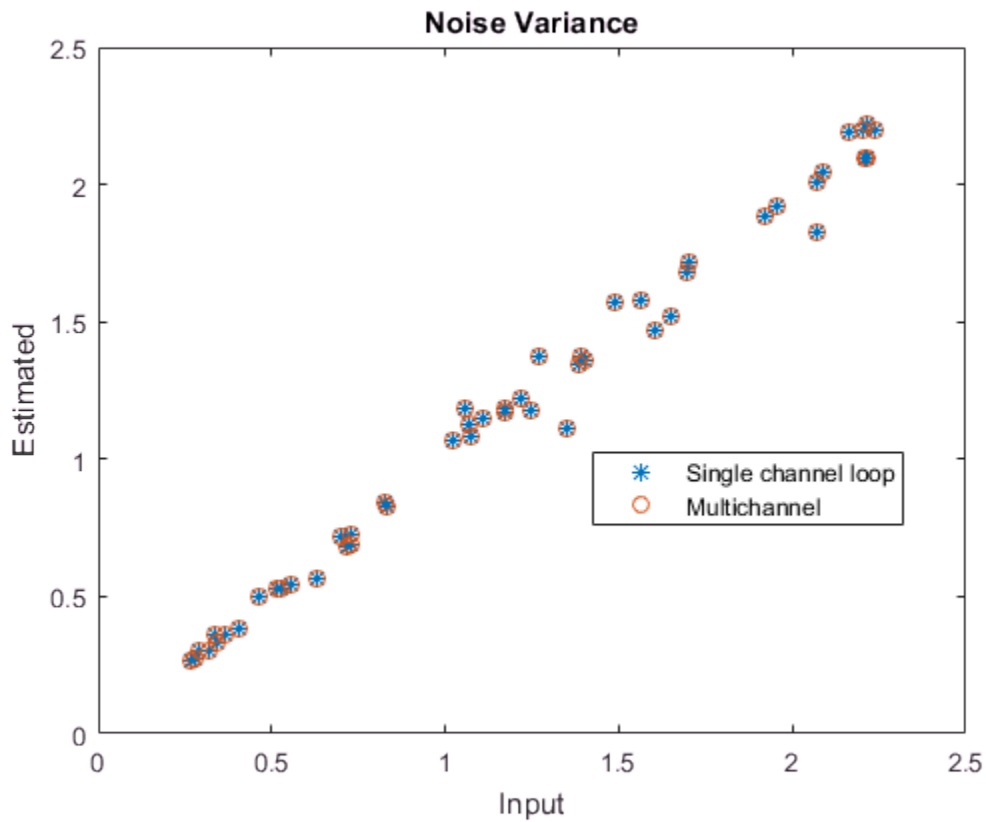

Definitions

AR(p) Model

Let $y(n)$ be a wide-sense stationary random process obtained by filtering white noise of variance e with the system function $A(z)$. If $P_y(e^{j\omega})$ is the power spectral density of $y(n)$, then

$$P_y(e^{j\omega}) = \frac{e}{|A(e^{j\omega})|^2} = \frac{e}{\left|1 + \sum_{k=1}^p a(k)e^{-j\omega k}\right|^2}.$$

Because the method characterizes the input data using an all-pole model, the correct choice of the model order, p , is important.

See Also

arburg | armcov | aryule | lpc | pcov | prony

Introduced before R2006a

armcov

Autoregressive all-pole model parameters — modified covariance method

Syntax

```
a = armcov(x,p)
[a,e] = armcov(x,p)
```

Description

`a = armcov(x,p)` uses the modified covariance method to fit a p th-order autoregressive (AR) model to the input signal, x , which is assumed to be the output of an AR system driven by white noise. This method minimizes the forward and backward prediction errors in the least-squares sense. The output array, \mathbf{a} , contains the normalized estimates of the AR system parameters, $A(z)$, in descending powers of z . \mathbf{a} has $p + 1$ columns. If x is a vector, then \mathbf{a} is a row vector. If \mathbf{a} is a matrix, then the coefficients along the n th row of \mathbf{a} model the n th column of x .

`[a,e] = armcov(x,p)` returns the variance estimate, \mathbf{e} , of the white noise input to the AR model.

Examples

Parameter Estimation Using the Modified Covariance Method

Use a vector of polynomial coefficients to generate an AR(4) process by filtering 1024 samples of white noise. Reset the random number generator for reproducible results. Use the modified covariance method to estimate the coefficients.

```
rng default
A = [1 -2.7607 3.8106 -2.6535 0.9238];
y = filter(1,A,0.2*randn(1024,1));
```

```
arcoeffs = armcov(y,4)
arcoeffs =
    1.0000   -2.7741    3.8404   -2.6841    0.9360
```

Generate 50 realizations of the process, changing each time the variance of the input noise. Compare the modified-covariance-estimated variances to the actual values.

```
nrealiz = 50;
noisestdz = rand(1,nrealiz)+0.5;
randnoise = randn(1024,nrealiz);
for k = 1:nrealiz
    y = filter(1,A,noisestdz(k) * randnoise(:,k));
    [arcoeffs,noisevar(k)] = armcov(y,4);
end

plot(noisestdz.^2,noisevar,'*')
title('Noise Variance')
xlabel('Input')
ylabel('Estimated')
```

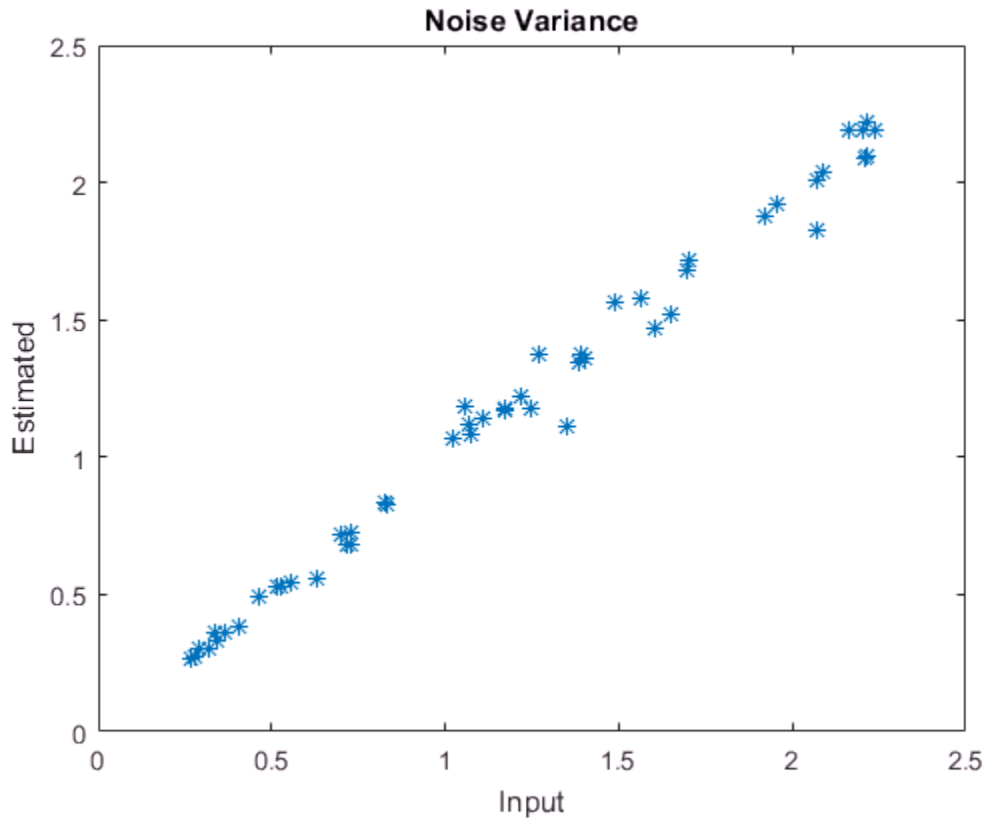

Repeat the procedure using `armcov`'s multichannel syntax.

```
realiz = bsxfun(@times,noisestdz,randnoise);
Y = filter(1,A,realiz);
[coeffs,variances] = armcov(Y,4);
hold on
plot(noisestdz.^2,variances,'o')
q = legend('Single channel loop','Multichannel');
q.Location = 'best';
```

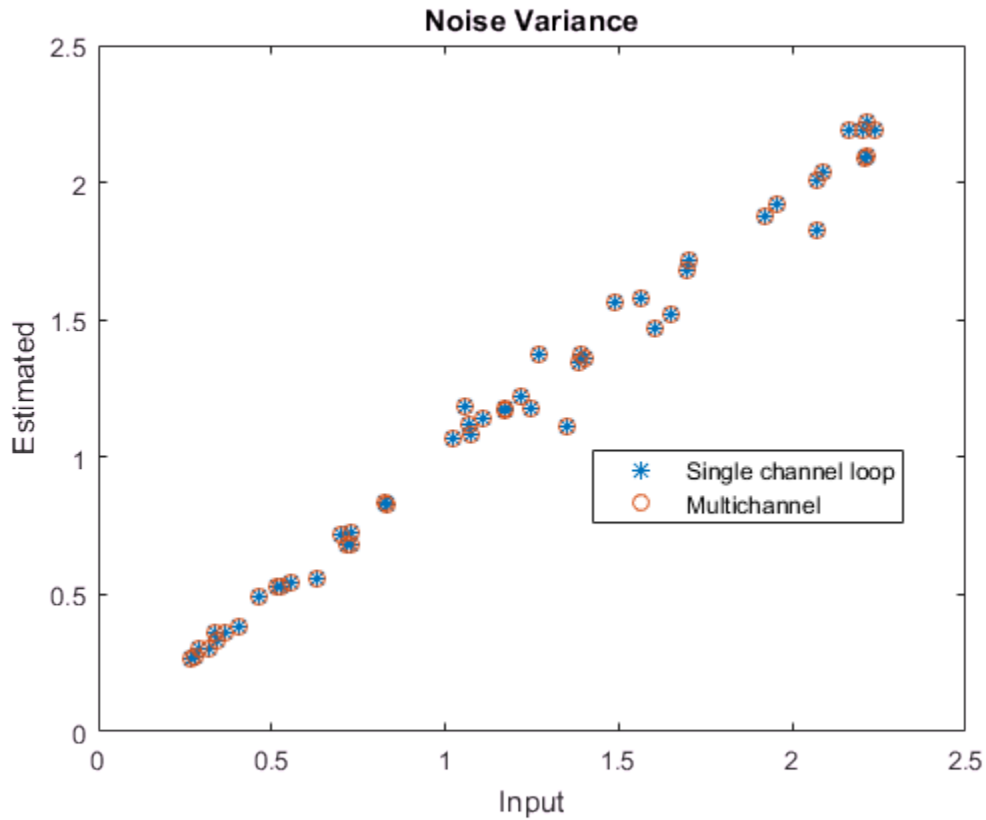

Definitions

AR(p) Model

Let $y(n)$ be a wide-sense stationary random process obtained by filtering a white noise input with variance e with the system function $A(z)$. If $P_y(e^{j\omega})$ is the power spectral density of $y(n)$, then

$$P_y(e^{j\omega}) = \frac{e}{|A(e^{j\omega})|^2} = \frac{e}{\left|1 + \sum_{k=1}^p a(k)e^{-j\omega k}\right|^2}.$$

Because the method characterizes the input data using an all-pole model, the correct choice of the model order, p , is important.

See Also

arburg | arcov | aryule | lpc | pmcov | prony

Introduced before R2006a

aryule

Autoregressive all-pole model parameters — Yule-Walker method

Syntax

```
a = aryule(x,p)
[a,e] = aryule(x,p)
[a,e,rc] = aryule(x,p)
```

Description

`a = aryule(x,p)` returns the normalized autoregressive (AR) parameters corresponding to a model of order `p` for the input array, `x`. If `x` is a vector, then the output array, `a`, is a row vector. If `x` is a matrix, then the parameters along the n th row of `a` model the n th column of `x`. `a` has `p + 1` columns. `p` must be less than the number of elements (or rows) of `x`.

`[a,e] = aryule(x,p)` returns the estimated variance, `e`, of the white noise input.

`[a,e,rc] = aryule(x,p)` returns the reflection coefficients in `rc`.

Examples

Parameter Estimation Using the Yule-Walker Method

Use a vector of polynomial coefficients to generate an AR(4) process by filtering 1024 samples of white noise. Reset the random number generator for reproducible results. Use the Yule-Walker method to estimate the coefficients.

```
rng default
A = [1 -2.7607 3.8106 -2.6535 0.9238];
y = filter(1,A,0.2*randn(1024,1));
```

```
arcoeffs = aryule(y,4)

arcoeffs =

    1.0000   -2.7262    3.7296   -2.5753    0.8927
```

Generate 50 realizations of the process, changing each time the variance of the input noise. Compare the Yule-Walker-estimated variances to the actual values.

```
nrealiz = 50;

noisestdz = rand(1,nrealiz)+0.5;

randnoise = randn(1024,nrealiz);

for k = 1:nrealiz
    y = filter(1,A,noisestdz(k) * randnoise(:,k));
    [arcoeffs,noisevar(k)] = aryule(y,4);
end

plot(noisestdz.^2,noisevar,'*')
title('Noise Variance')
xlabel('Input')
ylabel('Estimated')
```

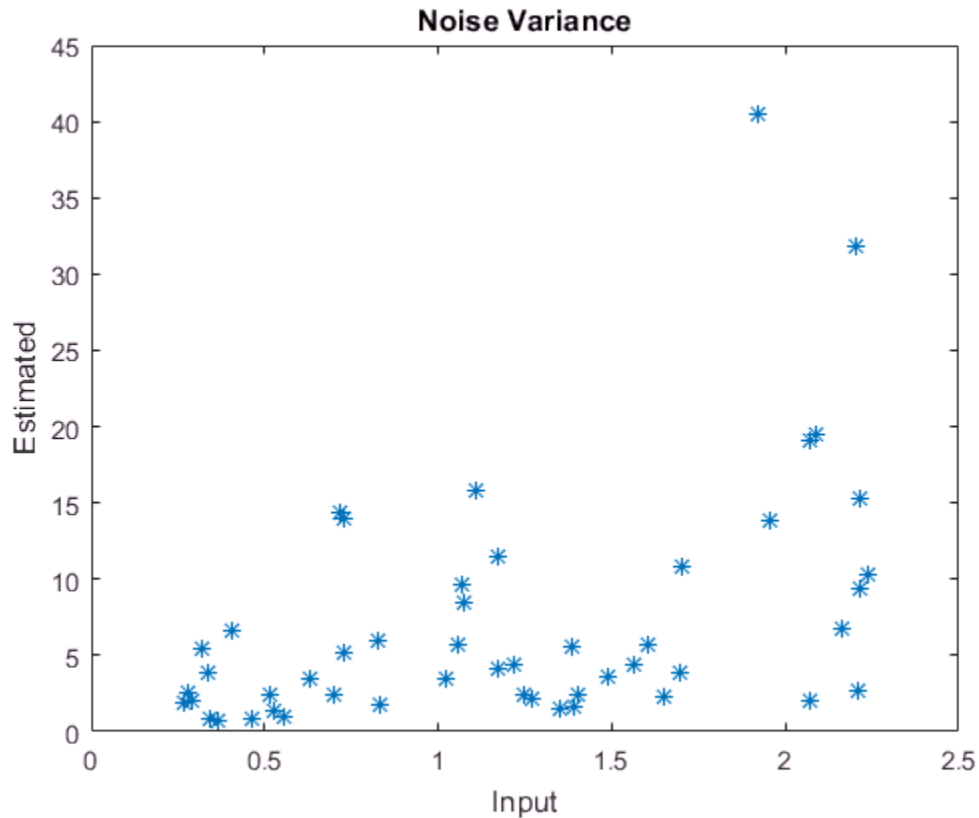

Repeat the procedure using `aryule`'s multichannel syntax.

```
realiz = bsxfun(@times,noisestdz,randnoise);
Y = filter(1,A,realiz);
[coeffs,variances] = aryule(Y,4);
hold on
plot(noisestdz.^2,variances,'o')
q = legend('Single channel loop','Multichannel');
q.Location = 'best';
```

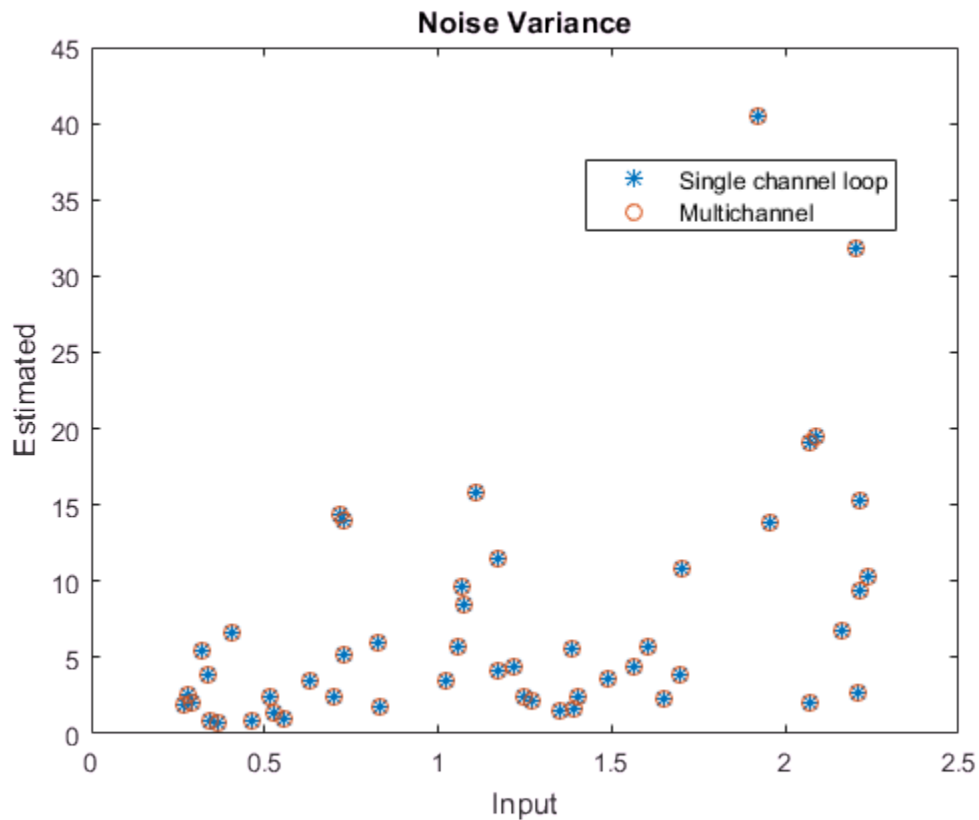
Estimate Model order Using Decay of Reflection Coefficients

Use a vector of polynomial coefficients to generate an AR(2) process by filtering 1024 samples of white noise. Reset the random number generator for reproducible results.

```
rng default
```

```
y = filter(1,[1 -0.75 0.5],0.2*randn(1024,1));
```

Use the Yule-Walker method to fit an AR(10) model to the process. Output and plot the reflection coefficients.

```
[ar_coeffs,NoiseVariance,reflect_coeffs] = aryule(y,10);
```

```
stem(reflect_coeffs)
axis([-0.05 10.5 -1 1])
title('Reflection Coefficients by Lag')
```

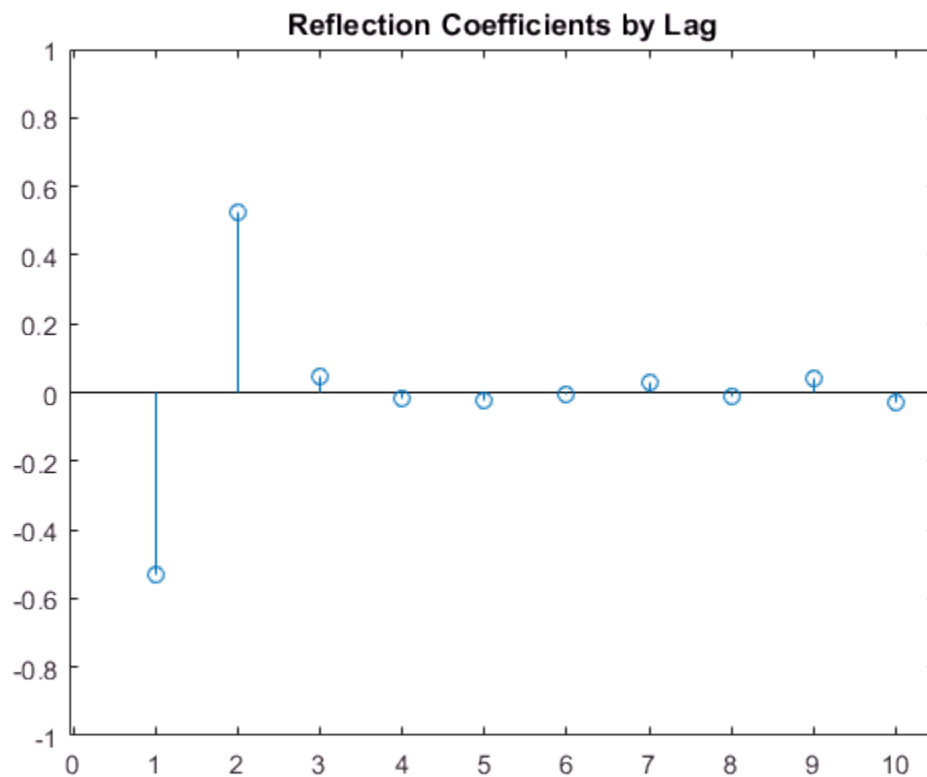

The reflection coefficients decay to zero after lag 2, which indicates that an AR(10) model significantly overestimates the time dependence in the data.

Definitions

AR(p) Model

In an AR model of order p , the current output is a linear combination of the past p outputs plus a white noise input. The weights on the p past outputs minimize the mean-square prediction error of the autoregression. If $y(n)$ is the current value of the output and $x(n)$ is a zero-mean white noise input, the AR(p) model is:

$$\sum_{k=0}^p a(k)y(n-k) = x(n).$$

Reflection Coefficients

The reflection coefficients are the partial autocorrelation coefficients scaled by -1 . The reflection coefficients indicate the time dependence between $y(n)$ and $y(n-k)$ after subtracting the prediction based on the intervening $k-1$ time steps.

Algorithms

aryule uses the Levinson-Durbin recursion on the biased estimate of the sample autocorrelation sequence to compute the parameters.

References

[1] Hayes, Monson H. *Statistical Digital Signal Processing and Modeling*. New York: John Wiley & Sons, 1996.

See Also

arburg | arcov | armcov | levinson | lpc

Topics

“Parametric Modeling”

Introduced before R2006a

bandpower

Band power

Syntax

```
p = bandpower(x)
p = bandpower(x,fs,freqrange)

p = bandpower(pxx,f,'psd')
p = bandpower(pxx,f,freqrange,'psd')
```

Description

`p = bandpower(x)` returns the average power in the input signal, `x`. If `x` is a matrix, then `bandpower` computes the average power in each column independently.

`p = bandpower(x,fs,freqrange)` returns the average power in the frequency range, `freqrange`, specified as a two-element vector. You must input the sampling frequency, `fs`, to return the power in a specified frequency range. `bandpower` uses a modified periodogram to determine the average power in `freqrange`.

`p = bandpower(pxx,f,'psd')` returns the average power computed by integrating the power spectral density (PSD) estimate, `pxx`. The integral is approximated by the rectangle method. The input, `f`, is a vector of frequencies corresponding to the PSD estimates in `pxx`. The `'psd'` option indicates that the input is a PSD estimate and not time series data.

`p = bandpower(pxx,f,freqrange,'psd')` returns the average power contained in the frequency interval, `freqrange`. If the frequencies in `freqrange` do not match values in `f`, the closest values are used. The average power is computed by integrating the power spectral density (PSD) estimate, `pxx`. The integral is approximated by the rectangle method. The `'psd'` option indicates the input is a PSD estimate and not time series data.

Examples

Comparison with Euclidean Norm

Create a signal consisting of a 100 Hz sine wave in additive $N(0,1)$ white Gaussian noise. The sampling frequency is 1 kHz. Determine the average power and compare it against the ℓ_2 norm.

```
t = 0:0.001:1-0.001;  
x = cos(2*pi*100*t)+randn(size(t));  
  
p = bandpower(x)  
  
p = 1.5264  
  
l2norm = norm(x,2)^2/numel(x)  
  
l2norm = 1.5264
```

Percentage of Total Power in Frequency Interval

Determine the percentage of the total power in a specified frequency interval.

Create a signal consisting of a 100 Hz sine wave in additive $N(0,1)$ white Gaussian noise. The sampling frequency is 1 kHz. Determine the percentage of the total power in the frequency interval between 50 Hz and 150 Hz. Reset the random number generator for reproducible results.

```
rng('default')  
  
t = 0:0.001:1-0.001;  
x = cos(2*pi*100*t)+randn(size(t));  
  
pband = bandpower(x,1000,[50 150]);  
ptot = bandpower(x,1000,[0 500]);  
per_power = 100*(pband/ptot)  
  
per_power = 51.9591
```

Periodogram Input

Determine the average power by first computing a PSD estimate using the periodogram. Input the PSD estimate to `bandpower`.

Create a signal consisting of a 100 Hz sine wave in additive $N(0,1)$ white Gaussian noise. The sampling frequency is 1 kHz. Obtain the periodogram and use the 'psd' flag to compute the average power using the PSD estimate. Compare the result against the average power computed in the time domain.

```
t = 0:0.001:1-0.001;
Fs = 1000;
x = cos(2*pi*100*t)+randn(size(t));

[Pxx,F] = periodogram(x,rectwin(length(x)),length(x),Fs);
p = bandpower(Pxx,F,'psd')

p = 1.5264

avpow = norm(x,2)^2/numel(x)

avpow = 1.5264
```

Percentage of Power in Frequency Band (Periodogram)

Determine the percentage of the total power in a specified frequency interval using the periodogram as the input.

Create a signal consisting of a 100 Hz sine wave in additive $N(0,1)$ white Gaussian noise. The sampling frequency is 1 kHz. Obtain the periodogram and corresponding frequency vector. Using the PSD estimate, determine the percentage of the total power in the frequency interval between 50 Hz and 150 Hz.

```
Fs = 1000;
t = 0:1/Fs:1-0.001;
x = cos(2*pi*100*t)+randn(size(t));

[Pxx,F] = periodogram(x,rectwin(length(x)),length(x),Fs);
pband = bandpower(Pxx,F,[50 100],'psd');
ptot = bandpower(Pxx,F,'psd');
per_power = 100*(pband/ptot)

per_power = 42.0767
```

Average Power of a Multichannel Signal

Create a multichannel signal consisting of three sinusoids in additive $N(0,1)$ white Gaussian noise. The sinusoids' frequencies are 100 Hz, 200 Hz, and 300 Hz. The sampling frequency is 1 kHz, and the signal has a duration of 1 s.

```
Fs = 1000;  
t = 0:1/Fs:1-1/Fs;  
f = [100;200;300];  
x = cos(2*pi*f*t)' + randn(length(t),3);
```

Determine the average power of the signal and compare it to the ℓ_2 norm.

```
p = bandpower(x)  
p =  
    1.5264    1.5382    1.4717
```

```
l2norm = dot(x,x)/length(x)  
l2norm =  
    1.5264    1.5382    1.4717
```

Input Arguments

x — Time series input

vector | matrix

Input time series data, specified as a row or column vector or as a matrix. If **x** is a matrix, then its columns are treated as independent channels.

Example: `cos(pi/4*(0:159))' + randn(160,1)` is a single-channel column-vector signal.

Example: `cos(pi./[4;2]*(0:159))' + randn(160,2)` is a two-channel noisy sinusoid.

Data Types: `double` | `single`

Complex Number Support: Yes

fs — Sampling frequency

1 (default) | positive scalar

Sampling frequency for the input time series data, specified as a positive scalar.

Data Types: `double` | `single`

freqrange — Frequency range for band power computation

two-element real-valued row or column vector

Frequency range for the band power computation, specified as a two-element real-valued row or column vector. If the input signal, x , contains N samples, `freqrange` must be within the following intervals.

- $[0, fs/2]$ if x is real-valued and N is even
- $[0, (N-1)fs/(2N)]$ if x is real-valued and N is odd
- $[-(N-2)fs/(2N), fs/2]$ if x is complex-valued and N is even
- $[-(N-1)fs/(2N), (N-1)fs/(2N)]$ if x is complex-valued and N is odd

Data Types: `double` | `single`

pxx — PSD estimates

real-valued column vector with nonnegative elements

One- or two-sided PSD estimate, specified as a column vector with nonnegative elements.

Data Types: `double` | `single`

f — Frequency vector for PSD estimates

column vector with real-valued elements

Frequency vector, specified as a column vector. The frequency vector, f , contains the frequencies corresponding to the PSD estimates in `pxx`.

Data Types: `double` | `single`

Output Arguments

p — Average band power

nonnegative scalar

Average band power, returned as a nonnegative scalar.

Data Types: `double` | `single`

See Also

See Also

periodogram | sfdr

Introduced in R2013a

barthannwin

Modified Bartlett-Hann window

Syntax

```
w = barthannwin(L)
```

Description

`w = barthannwin(L)` returns an L-point modified Bartlett-Hann window in the column vector `w`. Like Bartlett, Hann, and Hamming windows, this window has a mainlobe at the origin and asymptotically decaying sidelobes on both sides. It is a linear combination of weighted Bartlett and Hann windows with near sidelobes lower than both Bartlett and Hann and with far sidelobes lower than both Bartlett and Hamming windows. The mainlobe width of the modified Bartlett-Hann window is not increased relative to either Bartlett or Hann window mainlobes.

Note The Hann window is also called the Hanning window.

Examples

Bartlett-Hann Window

Create a 64-point Bartlett-Hann window. Display the result using `wvtool`.

```
L = 64;  
wvtool(barthannwin(L))
```

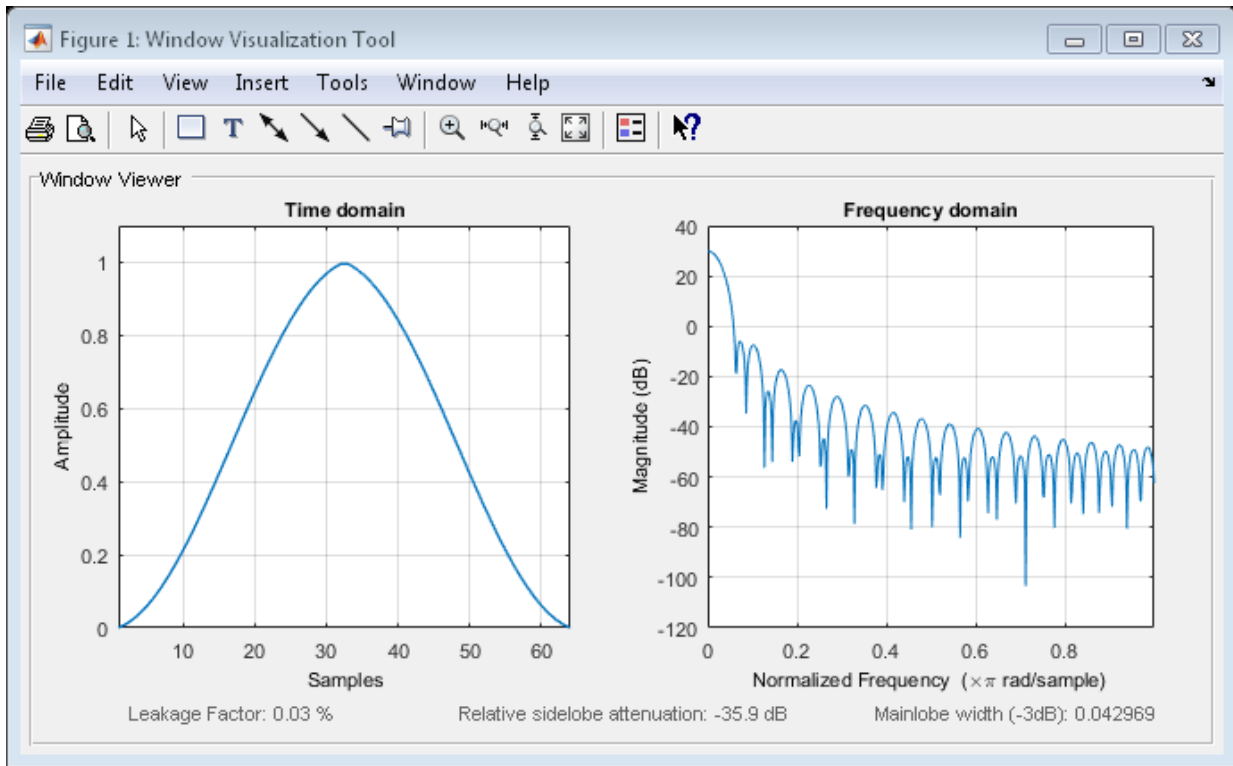

Algorithms

The equation for computing the coefficients of a Modified Bartlett-Hanning window is

$$w(n) = 0.62 - 0.48 \left| \left(\frac{n}{N} - 0.5 \right) \right| + 0.38 \cos \left(2\pi \left(\frac{n}{N} - 0.5 \right) \right)$$

where $0 \leq n \leq N$ and the window length is $L = N + 1$.

References

- [1] Ha, Y. H., and J. A. Pearce. “A New Window and Comparison to Standard Windows.” *IEEE® Transactions on Acoustics, Speech, and Signal Processing*. Vol. 37, Number 2, 1999, pp. 298–301.
- [2] Oppenheim, Alan V., Ronald W. Schafer, and John R. Buck. *Discrete-Time Signal Processing*. Upper Saddle River, NJ: Prentice Hall, 1999, p. 468.

Extended Capabilities

C/C++ Code Generation

Generate C and C++ code using MATLAB® Coder™.

Usage notes and limitations:

Window length must be a constant. Expressions or variables are allowed if their values do not change.

See Also

See Also

Apps

Window Designer

Functions

bartlett | blackmanharris | bohmanwin | nuttallwin | parzenwin | rectwin |
triang | window | wvtool

Introduced before R2006a

bartlett

Bartlett window

Syntax

```
w = bartlett(L)
```

Description

`w = bartlett(L)` returns an L -point Bartlett window in the column vector w , where L must be a positive integer. The coefficients of a Bartlett window are computed as follows:

$$w(n) = \begin{cases} \frac{2n}{N}, & 0 \leq n \leq \frac{N}{2} \\ 2 - \frac{2n}{N}, & \frac{N}{2} \leq n \leq N \end{cases}$$

The window length $L = N + 1$.

The Bartlett window is very similar to a triangular window as returned by the `triang` function. The Bartlett window always has zeros at the first and last samples, however, while the triangular window is nonzero at those points. For L odd, the center $L - 2$ points of `bartlett(L)` are equivalent to `triang(L-2)`.

Note If you specify a one-point window (set $L = 1$), the value 1 is returned.

Examples

Bartlett Window

Create a 64-point Bartlett window. Display the result using `wvtool`.

```
L = 64;  
bw = bartlett(L);  
wvtool(bw)
```

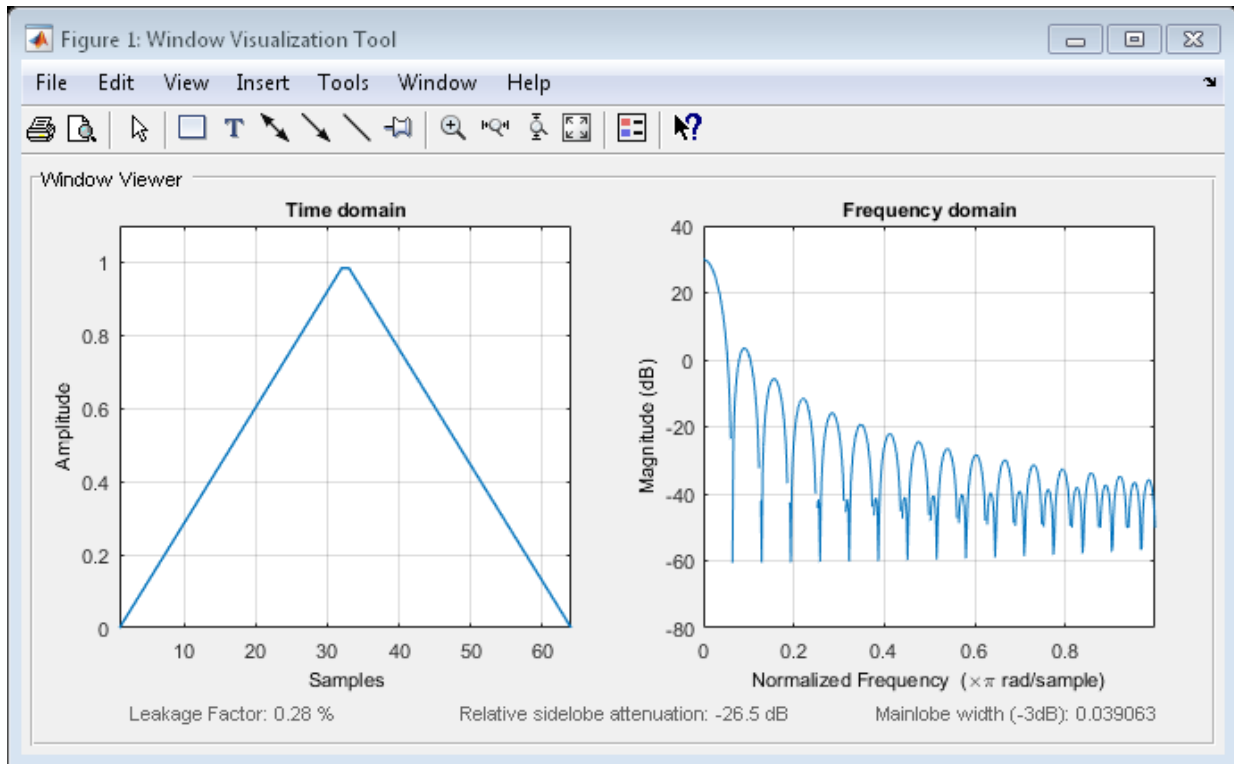

References

- [1] Oppenheim, Alan V., Ronald W. Schaffer, and John R. Buck. *Discrete-Time Signal Processing*. Upper Saddle River, NJ: Prentice Hall, 1999.

Extended Capabilities

C/C++ Code Generation

Generate C and C++ code using MATLAB® Coder™.

Usage notes and limitations:

Window length must be a constant. Expressions or variables are allowed if their values do not change.

See Also

See Also

Apps

Window Designer

Functions

barthannwin | blackmanharris | bohmanwin | nuttallwin | parzenwin |
rectwin | triang | window | wvtool

Introduced before R2006a

besselap

Bessel analog lowpass filter prototype

Syntax

`[z,p,k] = besselap(n)`

Description

`[z,p,k] = besselap(n)` returns the poles and gain of an order- n Bessel analog lowpass filter prototype. n must be less than or equal to 25. The function returns the poles in the length n column vector \mathbf{p} and the gain in scalar k . \mathbf{z} is an empty matrix because there are no zeros. The transfer function is

$$H(s) = \frac{k}{(s - p(1))(s - p(2)) \cdots (s - p(n))}$$

`besselap` normalizes the poles and gain so that at low frequency and high frequency the Bessel prototype is asymptotically equivalent to the Butterworth prototype of the same order [1]. The magnitude of the filter is less than $1/\sqrt{2}$ at the unity cutoff frequency $\Omega_c = 1$.

Analog Bessel filters are characterized by a group delay that is maximally flat at zero frequency and almost constant throughout the passband. The group delay at zero frequency is

$$\left(\frac{(2n)!}{2^n n!} \right)^{1/n}$$

Examples

Frequency Response of an Analog Bessel Filter

Design a 6th-order Bessel analog lowpass filter. Display its magnitude and phase responses.

```
[z,p,k] = besslap(6);           % Lowpass filter prototype
[num,den] = zp2tf(z,p,k);       % Convert to transfer function form
freqs(num,den)                  % Frequency response of analog filter
```

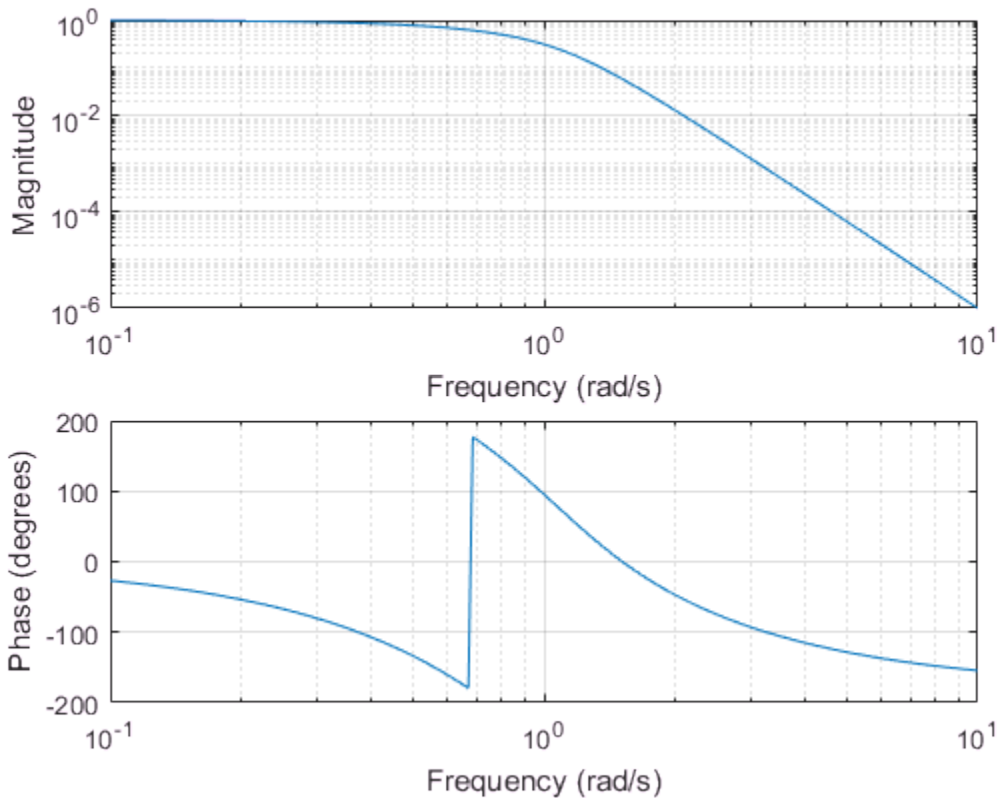

Algorithms

besslap finds the filter roots from a lookup table constructed using Symbolic Math Toolbox™ software.

References

- [1] Rabiner, L. R., and B. Gold. *Theory and Application of Digital Signal Processing*. Englewood Cliffs, NJ: Prentice-Hall, 1975, pp.228–230.

Extended Capabilities

C/C++ Code Generation

Generate C and C++ code using MATLAB® Coder™.

Usage notes and limitations:

Filter order must be a constant. Expressions or variables are allowed if their values do not change.

See Also

besself | buttap | cheb1ap | cheb2ap | ellipap

Introduced before R2006a

besself

Bessel analog filter design

Syntax

```
[b,a] = besself(n,Wo)
[z,p,k] = besself(...)
[A,B,C,D] = besself(...)
```

Description

`besself` designs lowpass, analog Bessel filters, which are characterized by almost constant group delay across the entire passband, thus preserving the wave shape of filtered signals in the passband. `besself` does not support the design of digital Bessel filters.

`[b,a] = besself(n,Wo)` designs an n th-order lowpass analog Bessel filter, where Wo is the angular frequency up to which the filter's group delay is approximately constant. Larger values of the filter order n produce a group delay that better approximates a constant up to frequency Wo .

`besself` returns the filter coefficients in the length $n+1$ row vectors `b` and `a`, with coefficients in descending powers of s , derived from this transfer function:

$$H(s) = \frac{B(s)}{A(s)} = \frac{b(1)s^n + b(2)s^{n-1} + \dots + b(n+1)}{a(1)s^n + a(2)s^{n-1} + \dots + a(n+1)}$$

`[z,p,k] = besself(...)` returns the zeros and poles in length n or $2*n$ column vectors `z` and `p` and the gain in the scalar `k`.

`[A,B,C,D] = besself(...)` returns the filter design in state-space form, where `A`, `B`, `C`, and `D` are

$$\begin{aligned}\dot{x} &= Ax + Bu \\ y &= Cx + Du.\end{aligned}$$

and u is the input, x is the state vector, and y is the output.

Examples

Frequency Response of an Analog Bessel Filter

Design a 5th-order analog lowpass Bessel filter with approximately constant group delay up to 10^4 rad/s. Plot the magnitude and phase responses of the filter using `freqs`.

```
[b,a] = besself(5,10000);  
freqs(b,a)
```

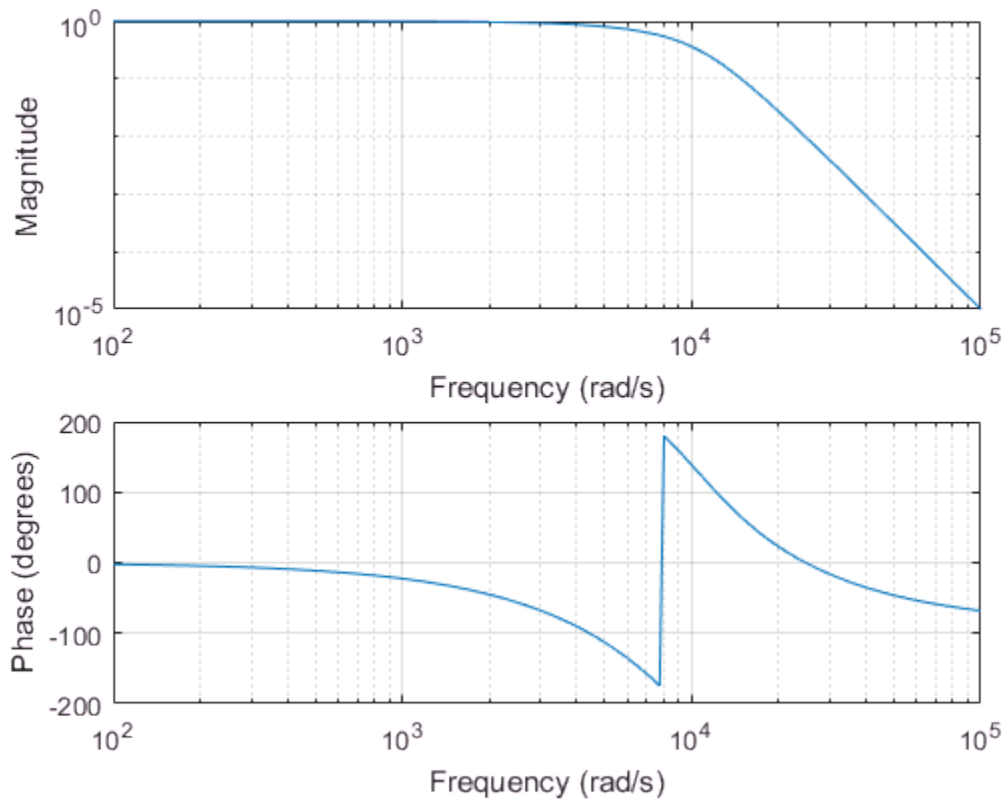

Frequency Response of a Digital Bessel Filter

Design an analog Bessel filter of order 5. Convert it to a digital IIR filter using `bilinear`. Display its frequency response.

```
Fs = 100; % Sampling Frequency
[z,p,k] = besself(5,1000); % Bessel analog filter design
[zd,pd,kd] = bilinear(z,p,k,Fs); % Analog to digital mapping
sos = zp2sos(zd,pd,kd); % Convert to SOS form
fvtool(sos) % Visualize the digital filter
```

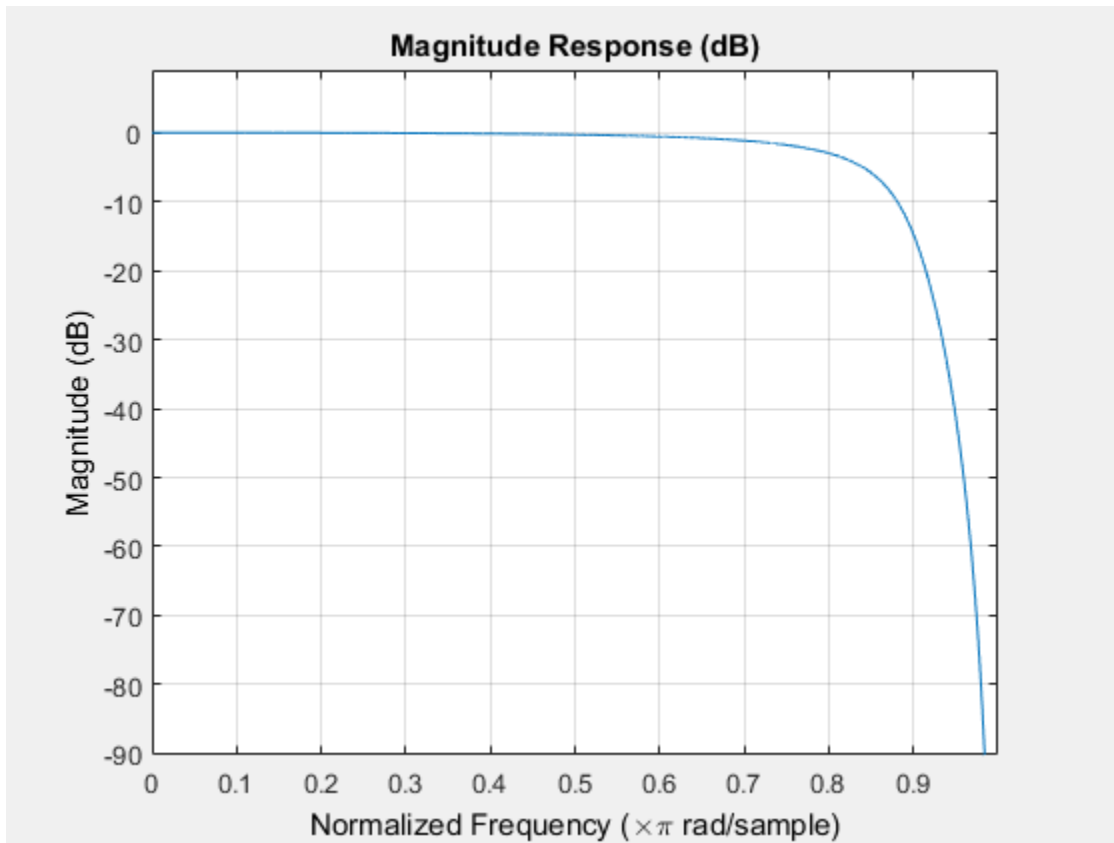

Limitations

Lowpass Bessel filters have a monotonically decreasing magnitude response, as do lowpass Butterworth filters. Compared to the Butterworth, Chebyshev, and elliptic filters, the Bessel filter has the slowest rolloff and requires the highest order to meet an attenuation specification.

For high order filters, the state-space form is the most numerically accurate, followed by the zero-pole-gain form. The transfer function coefficient form is the least accurate; numerical problems can arise for filter orders as low as 15.

Algorithms

`besself` performs a four-step algorithm:

- 1 It finds lowpass analog prototype poles, zeros, and gain using the `besselap` function.
- 2 It converts the poles, zeros, and gain into state-space form.
- 3 It transforms the lowpass prototype into a lowpass filter that meets the design specifications.
- 4 It converts the state-space filter back to transfer function or zero-pole-gain form, as required.

References

- [1] Parks, Thomas W., and C. Sidney Burrus. *Digital Filter Design*. New York: John Wiley & Sons, 1987.

See Also

`besselap` | `butter` | `cheby1` | `cheby2` | `ellip`

Introduced before R2006a

bilinear

Bilinear transformation method for analog-to-digital filter conversion

Syntax

```
[zd,pd,kd] = bilinear(z,p,k,fs)
[zd,pd,kd] = bilinear(z,p,k,fs,fp)
[numd,dend] = bilinear(num,den,fs)
[numd,dend] = bilinear(num,den,fs,fp)
[Ad,Bd,Cd,Dd] = bilinear(A,B,C,D,fs)
[Ad,Bd,Cd,Dd] = bilinear(A,B,C,D,fs,fp)
```

Description

The *bilinear transformation* is a mathematical mapping of variables. In digital filtering, it is a standard method of mapping the s or analog plane into the z or digital plane. It transforms analog filters, designed using classical filter design techniques, into their discrete equivalents.

The bilinear transformation maps the s -plane into the z -plane by

$$H(z) = H(s) \Big|_{s=2f_s \frac{z-1}{z+1}}.$$

This transformation maps the $j\Omega$ axis (from $\Omega = -\infty$ to $+\infty$) repeatedly around the unit circle ($e^{j\omega}$, from $\omega = -\pi$ to π) by

$$\omega = 2 \tan^{-1} \left(\frac{\Omega}{2f_s} \right).$$

`bilinear` can accept an optional parameter `Fp` that specifies prewarping. `fp`, in hertz, indicates a “match” frequency, that is, a frequency for which the frequency responses before and after mapping match exactly. In prewarped mode, the bilinear transformation maps the s -plane into the z -plane with

$$H(z) = H(s) \Big|_{s = \frac{2\pi f_p}{\tan\left(\pi \frac{f_p}{f_s}\right)} \frac{z-1}{z+1}}$$

With the prewarping option, **bilinear** maps the $j\Omega$ axis (from $\Omega = -\infty$ to $+\infty$) repeatedly around the unit circle ($e^{j\omega}$, from $\omega = -\pi$ to π) by

$$\omega = 2 \tan^{-1} \left(\frac{\Omega \tan\left(\pi \frac{f_p}{f_s}\right)}{2\pi f_p} \right)$$

In prewarped mode, **bilinear** matches the frequency $2\pi f_p$ (in radians per second) in the s -plane to the normalized frequency $2\pi f_p/f_s$ (in radians per second) in the z -plane.

The **bilinear** function works with three different linear system representations: zero-pole-gain, transfer function, and state-space form.

Zero-Pole-Gain

`[zd, pd, kd] = bilinear(z, p, k, fs)` and

`[zd, pd, kd] = bilinear(z, p, k, fs, fp)` convert the s -domain transfer function specified by **z**, **p**, and **k** to a discrete equivalent. Inputs **z** and **p** are column vectors containing the zeros and poles, **k** is a scalar gain, and **fs** is the sampling frequency in hertz. **bilinear** returns the discrete equivalent in column vectors **zd** and **pd** and scalar **kd**. The optional match frequency, **fp** is in hertz and is used for prewarping.

Transfer Function

`[numd, dend] = bilinear(num, den, fs)` and

`[numd, dend] = bilinear(num, den, fs, fp)` convert an s -domain transfer function given by **num** and **den** to a discrete equivalent. Row vectors **num** and **den** specify the coefficients of the numerator and denominator, respectively, in descending powers of s . Let $B(s)$ be the numerator polynomial and $A(s)$ be the denominator polynomial. The transfer function is:

$$\frac{B(s)}{A(s)} = \frac{B(1)s^n + \dots + B(n)s + B(n+1)}{A(1)s^m + \dots + A(m)s + A(m+1)}$$

`fs` is the sampling frequency in hertz. `bilinear` returns the discrete equivalent in row vectors `numd` and `dend` in descending powers of z (ascending powers of z^{-1}). `fp` is the optional match frequency, in hertz, for prewarping.

State-Space

`[Ad,Bd,Cd,Dd] = bilinear(A,B,C,D,fs)` and

`[Ad,Bd,Cd,Dd] = bilinear(A,B,C,D,fs,fp)` convert the continuous-time state-space system in matrices `A`, `B`, `C`, `D`

$$\begin{aligned} \dot{x} &= Ax + Bu \\ y &= Cx + Du \end{aligned}$$

to the discrete-time system:

$$\begin{aligned} x[n+1] &= A_d x[n] + B_d u[n], \\ y[n] &= C_d x[n] + D_d u[n]. \end{aligned}$$

`fs` is the sampling frequency in hertz. `bilinear` returns the discrete equivalent in matrices `Ad`, `Bd`, `Cd`, `Dd`. The optional match frequency, `fp` is in hertz and is used for prewarping.

Examples

Discrete-Time Representation of an Elliptic Filter

Design a 6th-order elliptic analog lowpass filter with 5 dB of ripple in the passband and a stopband 90 dB down. Use `bilinear` to transform it to a discrete-time IIR filter.

```
Fs = 0.5; % Sampling frequency
[z,p,k] = ellipap(6,5,90); % Lowpass filter prototype
[num,den] = zp2tf(z,p,k); % Convert to transfer function form
[numd,dend] = bilinear(num,den,Fs); % Analog to digital conversion
fvtool(numd,dend) % Visualize the filter
```

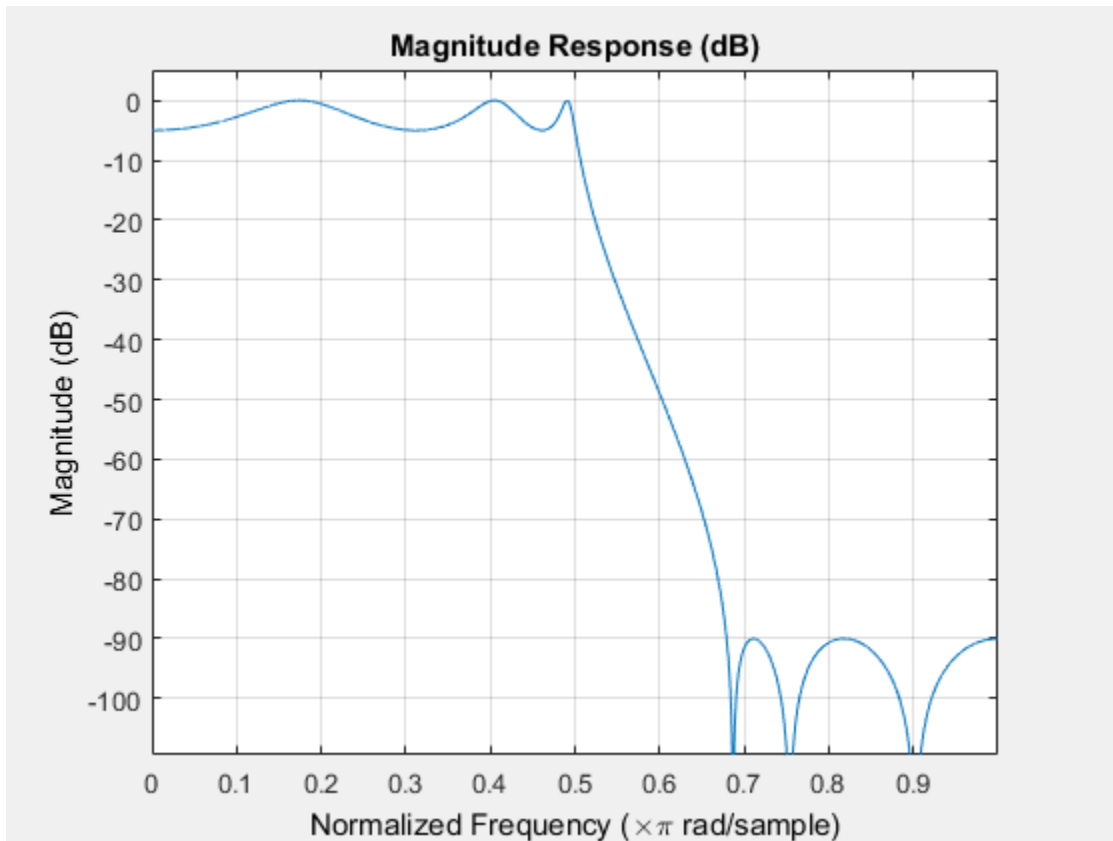

Diagnostics

`bilinear` requires that the numerator order be no greater than the denominator order. If this is not the case, `bilinear` displays

Numerator cannot be higher order than denominator.

For `bilinear` to distinguish between the zero-pole-gain and transfer function linear system formats, the first two input parameters must be vectors with the same orientation in these cases. If this is not the case, `bilinear` displays

First two arguments must have the same orientation.

Algorithms

`bilinear` uses one of two algorithms depending on the format of the input linear system you supply. One algorithm works on the zero-pole-gain format and the other on the state-space format. For transfer function representations, `bilinear` converts to state-space form, performs the transformation, and converts the resulting state-space system back to transfer function form.

Zero-Pole-Gain Algorithm

For a system in zero-pole-gain form, `bilinear` performs four steps:

- 1 If `fp` is present, it prewarps:

```
fp = 2*pi*fp;  
fs = fp/tan(fp/fs/2)
```

otherwise, `fs = 2*fs`.

- 2 It strips any zeros at $\pm\infty$ using

```
z = z(finite(z));
```

- 3 It transforms the zeros, poles, and gain using

```
pd = (1+p/fs)./(1-p/fs);    % Do bilinear transformation  
zd = (1+z/fs)./(1-z/fs);  
kd = real(k*prod(fs-z)./prod(fs-p));
```

- 4 It adds extra zeros at -1 so the resulting system has equivalent numerator and denominator order.

State-Space Algorithm

For a system in state-space form, `bilinear` performs two steps:

- 1 If `fp` is present, let

$$\lambda = \frac{\pi f_p}{\tan(\pi f_p / f_s)}.$$

If `fp` is not present, let $\lambda = fs$.

- 2 Compute A_d , B_d , C_d , and D_d in terms of A , B , C , and D using

$$A_d = (I - A \frac{1}{2\lambda})^{-1} (I + A \frac{1}{2\lambda}),$$

$$B_d = \frac{1}{\sqrt{\lambda}} (I - A \frac{1}{2\lambda})^{-1} B,$$

$$C_d = \frac{1}{\sqrt{\lambda}} C (I - A \frac{1}{2\lambda})^{-1},$$

$$D_d = \frac{1}{2\lambda} C (I - A \frac{1}{2\lambda})^{-1} B + D.$$

References

- [1] Parks, Thomas W., and C. Sidney Burrus. *Digital Filter Design*. New York: John Wiley & Sons, 1987, pp.209–213.
- [2] Oppenheim, Alan V., Ronald W. Schafer, and John R. Buck. *Discrete-Time Signal Processing*. Upper Saddle River, NJ: Prentice Hall, 1999, pp.450–454.

See Also

`impinvar` | `lp2bp` | `lp2bs` | `lp2hp` | `lp2lp`

Introduced before R2006a

bitrevorder

Permute data into bit-reversed order

Syntax

```
y = bitrevorder(x)
[y,i] = bitrevorder(x)
```

Description

`bitrevorder` is useful for pre-arranging filter coefficients so that bit-reversed ordering does not have to be performed as part of an `fft` or inverse FFT (`ifft`) computation.

This can improve run-time efficiency for external applications or for Simulink® blockset models. Both MATLAB `fft` and `ifft` functions process linear input and output.

Note Using `bitrevorder` is equivalent to using `digitrevorder` with radix base 2.

`y = bitrevorder(x)` returns the input data in bit-reversed order in vector or matrix `y`. The length of `x` must be an integer power of 2. If `x` is a matrix, the bit-reversal occurs on the first dimension of `x` with size greater than 1. `y` is the same size as `x`.

`[y,i] = bitrevorder(x)` returns the bit-reversed vector or matrix `y` and the bit-reversed indices `i`, such that `y = x(i)`. Recall that MATLAB matrices use 1-based indexing, so the first index of `y` will be 1, not 0.

The following table shows the numbers 0 through 7, the corresponding bits, and the bit-reversed numbers.

Linear Index	Bits	Bit- Reversed	Bit-Reversed Index
0	000	000	0
1	001	100	4
2	010	010	2
3	011	110	6

Linear Index	Bits	Bit- Reversed	Bit-Reversed Index
4	100	001	1
5	101	101	5
6	110	011	3
7	111	111	7

Examples

Vector in Bit-Reversed Order

Create a column vector and obtain its bit-reversed version. Verify by displaying the binary representation explicitly.

```
x = (0:15)';
v = bitrevorder(x);
```

```
x_bin = dec2bin(x);
v_bin = dec2bin(v);
```

```
T = table(x,x_bin,v,v_bin)
```

```
T = 16x4 table
    x    x_bin    v    v_bin
    ---  ---  ---  ---
     0    0000     0    0000
     1    0001     8    1000
     2    0010     4    0100
     3    0011    12    1100
     4    0100     2    0010
     5    0101    10    1010
     6    0110     6    0110
     7    0111    14    1110
     8    1000     1    0001
     9    1001     9    1001
    10    1010     5    0101
    11    1011    13    1101
    12    1100     3    0011
    13    1101    11    1011
    14    1110     7    0111
```

15 1111 15 1111

Extended Capabilities

C/C++ Code Generation

Generate C and C++ code using MATLAB® Coder™.

See Also

`ifft` | `fft` | `digitrevorder`

Introduced before R2006a

blackman

Blackman window

Syntax

```
w = blackman(N)
w = blackman(N,SFLAG)
```

Description

`w = blackman(N)` returns the N-point symmetric Blackman window in the column vector `w`, where `N` is a positive integer.

`w = blackman(N,SFLAG)` returns an N-point Blackman window using the window sampling specified by '`sflag`', which can be either '`periodic`' or '`symmetric`' (the default). The '`periodic`' flag is useful for DFT/FFT purposes, such as in spectral analysis. The DFT/FFT contains an implicit periodic extension and the periodic flag enables a signal windowed with a periodic window to have perfect periodic extension. When '`periodic`' is specified, `blackman` computes a length `N+1` window and returns the first `N` points. When using windows for filter design, the '`symmetric`' flag should be used.

See “Algorithms” on page 1-68 for a description of the difference between the symmetric and periodic windows.

Note If you specify a one-point window (set `N = 1`), the value `1` is returned.

Examples

Blackman Window

Create a 64-point Blackman window. Display the result using `wvtool`.

```
L = 64;
```

`wvtool(blackman(L))`

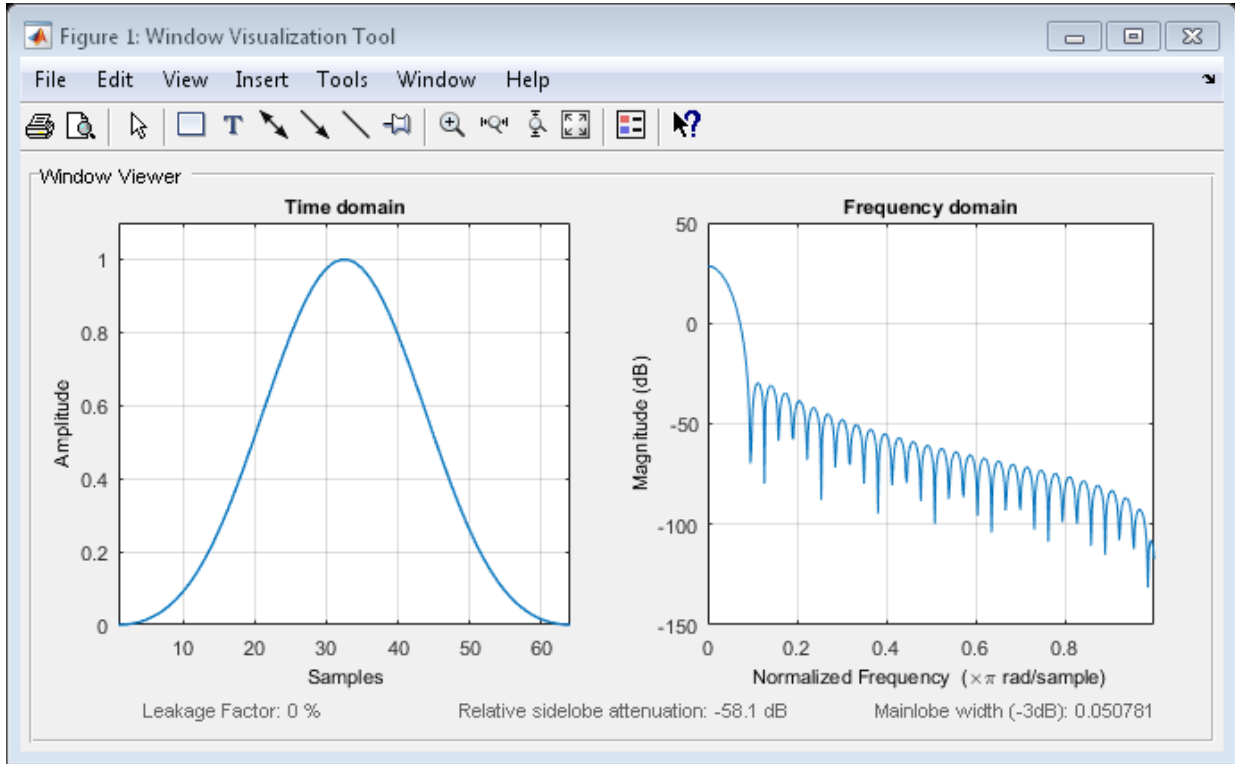

Algorithms

Blackman Window

The following equation defines the Blackman window of length N :

$$w(n) = 0.42 - 0.5 \cos \frac{2\pi n}{N-1} + 0.08 \cos \frac{4\pi n}{N-1}, \quad 0 \leq n \leq M-1$$

where M is $N/2$ for N even and $(N+1)/2$ for N odd.

In the *symmetric* case, the second half of the Blackman window $M \leq n \leq N - 1$ is obtained by flipping the first half around the midpoint. The symmetric option is the preferred method when using a Blackman window in FIR filter design.

The *periodic* Blackman window is constructed by extending the desired window length by one sample to $N + 1$, constructing a symmetric window, and removing the last sample. The periodic version is the preferred method when using a Blackman window in spectral analysis because the discrete Fourier transform assumes periodic extension of the input vector.

References

- [1] Oppenheim, Alan V., Ronald W. Schaffer, and John R. Buck. *Discrete-Time Signal Processing*. Upper Saddle River, NJ: Prentice Hall, 1999, pp. 468–471.

Extended Capabilities

C/C++ Code Generation

Generate C and C++ code using MATLAB® Coder™.

Usage notes and limitations:

Window length must be a constant. Expressions or variables are allowed if their values do not change.

See Also

See Also

Apps

Window Designer

Functions

flattopwin | hamming | hann | window | wvtool

Introduced before R2006a

blackmanharris

Minimum 4-term Blackman-Harris window

Syntax

```
w = blackmanharris(N)
w = blackmanharris(N,SFLAG)
```

Description

`w = blackmanharris(N)` returns an N -point symmetric 4-term Blackman-Harris window in the column vector w . The window is minimum in the sense that its maximum sidelobes are minimized.

`w = blackmanharris(N,SFLAG)` uses `SFLAG` window sampling. `SFLAG` can be 'symmetric' or 'periodic'. The default is 'symmetric'. You can find the equations defining the symmetric and periodic windows in “Algorithms” on page 1-72.

Examples

Blackman-Harris Window

Create a 32-point symmetric Blackman-Harris window. Display the result using `wvtool`.

```
N = 32;
wvtool(blackmanharris(N))
```

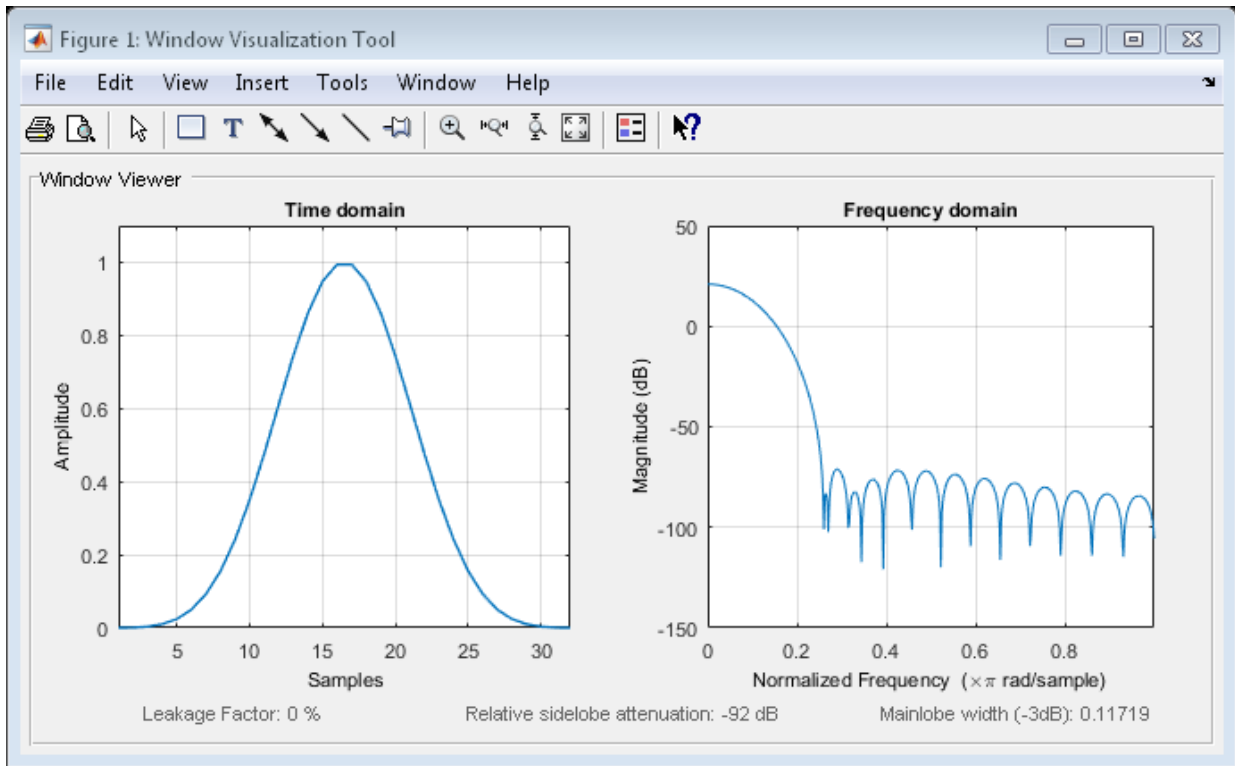

Algorithms

The equation for the **symmetric** 4-term Blackman-harris window of length N is

$$w(n) = a_0 - a_1 \cos\left(\frac{2\pi n}{N-1}\right) + a_2 \cos\left(\frac{4\pi n}{N-1}\right) - a_3 \cos\left(\frac{6\pi n}{N-1}\right), \quad 0 \leq n \leq N-1$$

The equation for the **periodic** 4-term Blackman-harris window of length N is

$$w(n) = a_0 - a_1 \cos\frac{2\pi n}{N} + a_2 \cos\frac{4\pi n}{N} - a_3 \cos\frac{6\pi n}{N}, \quad 0 \leq n \leq N-1$$

The periodic window is N-periodic.

The following table lists the coefficients:

Coefficient	Value
a_0	0.35875
a_1	0.48829
a_2	0.14128
a_3	0.01168

References

- [1] Harris, Fredric J. "On the Use of Windows for Harmonic Analysis with the Discrete Fourier Transform." *Proceedings of the IEEE*. Vol. 66, January 1978, pp. 51–83.

Extended Capabilities

C/C++ Code Generation

Generate C and C++ code using MATLAB® Coder™.

Usage notes and limitations:

Window length must be a constant. Expressions or variables are allowed if their values do not change.

See Also

See Also

Apps

Window Designer

Functions

barthannwin | bartlett | bohmanwin | nuttallwin | parzenwin | rectwin |
triang | window | wvtool

Introduced before R2006a

bohmanwin

Bohman window

Syntax

```
w = bohmanwin(L)
```

Description

`w = bohmanwin(L)` returns an L-point Bohman window in column vector `w`. A Bohman window is the convolution of two half-duration cosine lobes. In the time domain, it is the product of a triangular window and a single cycle of a cosine with a term added to set the first derivative to zero at the boundary. Bohman windows fall off as $1/w^4$.

Examples

Bohman Window

Compute a 64-point Bohman window. Display the result using `wvtool`.

```
L = 64;  
bw = bohmanwin(L);  
wvtool(bw)
```

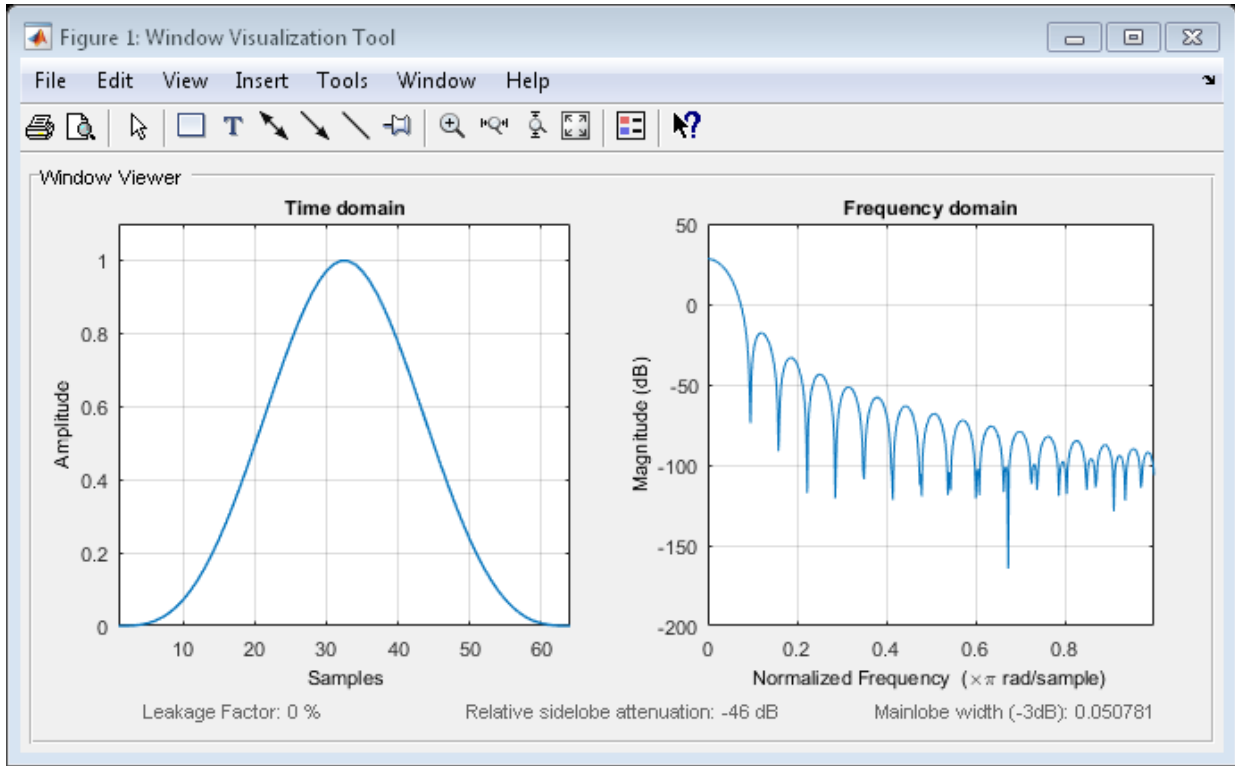

Algorithms

The equation for computing the coefficients of a Bohman window is

$$w(x) = (1 - |x|) \cos(\pi |x|) + \frac{1}{\pi} \sin(\pi |x|), \quad -1 \leq x \leq 1$$

where x is a length- L vector of linearly spaced values generated using `linspace`. The first and last elements of the Bohman window are forced to be identically zero.

References

- [1] Harris, Fredric J. “On the Use of Windows for Harmonic Analysis with the Discrete Fourier Transform.” *Proceedings of the IEEE*. Vol. 66, January 1978, pp. 51–83.

Extended Capabilities

C/C++ Code Generation

Generate C and C++ code using MATLAB® Coder™.

Usage notes and limitations:

Window length must be a constant. Expressions or variables are allowed if their values do not change.

See Also

See Also

Apps

Window Designer

Functions

barthannwin | bartlett | blackmanharris | nuttallwin | parzenwin | rectwin
| triang | window | wvtool

Introduced before R2006a

buffer

Buffer signal vector into matrix of data frames

Syntax

```

y = buffer(x,n)
y = buffer(x,n,p)
y = buffer(x,n,p,opt)
[y,z] = buffer(...)
[y,z,opt] = buffer(...)

```

Description

`y = buffer(x,n)` partitions a length- L signal vector x into nonoverlapping data segments (frames) of length n . Each data frame occupies one column of matrix output y , which has n rows and $\text{ceil}(L/n)$ columns. If L is not evenly divisible by n , the last column is zero-padded to length n .

`y = buffer(x,n,p)` overlaps or underlaps successive frames in the output matrix by p samples:

- For $0 < p < n$ (overlap), `buffer` repeats the final p samples of each frame at the beginning of the following frame. For example, if $x = 1:30$ and $n = 7$, an overlap of $p = 3$ looks like this.

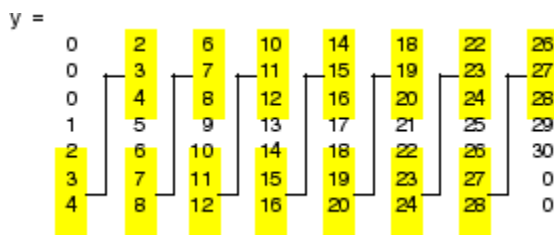

The first frame starts with p zeros (the default initial condition), and the number of columns in y is $\text{ceil}(L/(n-p))$.

- For $p < 0$ (underlap), `buffer` skips p samples between consecutive frames. For example, if $x = 1:30$ and $n = 7$, a buffer with underlap of $p = -3$ looks like this.

```

y =
  1  11  21
  2  12  22
  3  13  23
  4  14  24
  5  15  25
  6  16  26
  7  17  27

```

skipped { 8 18 28 }
 { 9 19 29 }
 { 10 20 30 }

The number of columns in y is $\text{ceil}(L / (n - p))$.

$y = \text{buffer}(x, n, p, \text{opt})$ specifies a vector of samples to precede $x(1)$ in an overlapping buffer, or the number of initial samples to skip in an underlapping buffer:

- For $0 < p < n$ (overlap), opt specifies a length- p vector to insert before $x(1)$ in the buffer. This vector can be considered an *initial condition*, which is needed when the current buffering operation is one in a sequence of consecutive buffering operations. To maintain the desired frame overlap from one buffer to the next, opt should contain the final p samples of the previous buffer in the sequence. See “Continuous Buffering” on page 1-85 below.

By default, opt is $\text{zeros}(p, 1)$ for an overlapping buffer. Set opt to 'nodelay' to skip the initial condition and begin filling the buffer immediately with $x(1)$. In this case, L must be $\text{length}(p)$ or longer. For example, if $x = 1:30$ and $n = 7$, a buffer with overlap of $p = 3$ looks like this.

```

y =
  1  5  9  13  17  21  25
  2  6  10 14  18  22  26
  3  7  11 15  19  23  27
  4  8  12 16  20  24  28
  5  9  13 17  21  25  29
  6 10 14 18  22  26  30
  7 11 15 19  23  27  0

```

- For $p < 0$ (underlap), opt is an integer value in the range $[0, -p]$ specifying the number of initial input samples, $x(1:\text{opt})$, to skip before adding samples to the buffer. The first value in the buffer is therefore $x(\text{opt}+1)$. By default, opt is zero for an underlapping buffer.

This option is especially useful when the current buffering operation is one in a sequence of consecutive buffering operations. To maintain the desired frame underlap from one buffer to the next, opt should equal the difference between the total number

of points to skip between frames (p) and the number of points that were *available* to be skipped in the previous input to `buffer`. If the previous input had fewer than p points that could be skipped after filling the final frame of that buffer, the remaining `opt` points need to be removed from the first frame of the current buffer. See “Continuous Buffering” on page 1-85 for an example of how this works in practice.

`[y,z] = buffer(...)` partitions the length- L signal vector x into frames of length n , and outputs only the *full* frames in y . If y is an overlapping buffer, it has n rows and m columns, where $m = \text{floor}(L/(n-p))$ when `length(opt) = p` or $m = \text{floor}((L-n)/(n-p))+1$ when `opt = 'nodelay'`.

If y is an underlapping buffer, it has n rows and m columns, where $m = \text{floor}((L-\text{opt})/(n-p)) + (\text{rem}(L-\text{opt}, (n-p)) \geq n)$.

If the number of samples in the input vector (after the appropriate overlapping or underlapping operations) exceeds the number of places available in the n -by- m buffer, the remaining samples in x are output in vector z , which for an overlapping buffer has length $L - m*(n-p)$ when `length(opt) = p` or $L - ((m-1)*(n-p)+n)$ when `opt = 'nodelay'`, and for an underlapping buffer has length $(L-\text{opt}) - m*(n-p)$.

Output z shares the same orientation (row or column) as x . If there are no remaining samples in the input after the buffer with the specified overlap or underlap is filled, z is an empty vector.

`[y,z,opt] = buffer(...)` returns the last p samples of a overlapping buffer in output `opt`. In an underlapping buffer, `opt` is the difference between the total number of points to skip between frames ($-p$) and the number of points in x that were *available* to be skipped after filling the last frame:

- For $0 < p < n$ (overlap), `opt` (as an output) contains the final p samples in the last frame of the buffer. This vector can be used as the *initial condition* for a subsequent buffering operation in a sequence of consecutive buffering operations. This allows the desired frame overlap to be maintained from one buffer to the next. See “Continuous Buffering” on page 1-85 below.
- For $p < 0$ (underlap), `opt` (as an output) is the difference between the total number of points to skip between frames ($-p$) and the number of points in x that were *available* to be skipped after filling the last frame: `opt = m*(n-p) + opt - L` where `opt` on the right is the input argument to `buffer`, and `opt` on the left is the output argument. z is the empty vector. Here m is the number of columns in the buffer, which is $m = \text{floor}((L-\text{opt})/(n-p)) + (\text{rem}(L-\text{opt}, (n-p)) \geq n)$.

Note that for an underlapping buffer output `opt` is always zero when output `z` contains data.

The `opt` output for an underlapping buffer is especially useful when the current buffering operation is one in a sequence of consecutive buffering operations. The `opt` output from each buffering operation specifies the number of samples that need to be skipped at the start of the next buffering operation to maintain the desired frame underlap from one buffer to the next. If fewer than `p` points were available to be skipped after filling the final frame of the current buffer, the remaining `opt` points need to be removed from the first frame of the next buffer.

In a sequence of buffering operations, the `opt` output from each operation should be used as the `opt` input to the subsequent buffering operation. This ensures that the desired frame overlap or underlap is maintained from buffer to buffer, as well as from frame to frame within the same buffer. See “Continuous Buffering” on page 1-85 below for an example of how this works in practice.

Examples

Continuous Overlapping Buffers

Create a buffer containing 100 frames, each with 11 samples.

```
data = buffer(1:1100,11);
```

Take the frames (columns) in the matrix `data` to be the sequential outputs of a data acquisition board sampling a physical signal: `data(:,1)` is the first D/A output, containing the first 11 signal samples; `data(:,2)` is the second output, containing the next 11 signal samples, and so on.

You want to rebuffer this signal from the acquired frame size of 11 to a frame size of 4 with an overlap of 1. Call `buffer` to operate on each successive input frame, using the `opt` parameter to maintain consistency in the overlap from one buffer to the next.

Set the buffer parameters. Specify a value of -5 for `y(1)`. The carryover vector is empty initially.

```
n = 4;  
p = 1;  
opt = -5;  
z = [];
```

Now repeatedly call `buffer`, each time passing in a new signal frame (column) from `data`. Overflow samples (returned in `z`) are carried over and prepended to the input in the subsequent call to `buffer`.

```
for i = 1:size(data,2)
    x = data(:,i);
    [y,z,opt] = buffer([z;x],n,p,opt);
end
```

Here's what happens during the first four iterations.

Iteration	Input frame [z;x]'	opt (input)	opt (output)	Output buffer (y)	Overflow (z)
i=1	[1:11]	-5	9	$\begin{bmatrix} -5 & 3 & 6 \\ 1 & 4 & 7 \\ 2 & 5 & 8 \\ 3 & 6 & 9 \end{bmatrix}$	[10 11]
i=2	[10 11 12:22]	9	21	$\begin{bmatrix} 9 & 12 & 15 & 18 \\ 10 & 13 & 16 & 19 \\ 11 & 14 & 17 & 20 \\ 12 & 15 & 18 & 21 \end{bmatrix}$	[22]
i=3	[22 23:33]	21	33	$\begin{bmatrix} 21 & 24 & 27 & 30 \\ 22 & 25 & 28 & 31 \\ 23 & 26 & 29 & 32 \\ 24 & 27 & 30 & 33 \end{bmatrix}$	[]
i=4	[34:44]	33	42	$\begin{bmatrix} 33 & 36 & 39 \\ 34 & 37 & 40 \\ 35 & 38 & 41 \\ 36 & 39 & 42 \end{bmatrix}$	[43 44]

The size of the output matrix, `y`, can vary by a single column from one iteration to the next. This is typical for buffering operations with overlap or underlap.

Continuous Underlapping Buffers

Create a buffer containing 100 frames, each with 11 samples.

```
data = buffer(1:1100,11);
```

Take `data(:,1)` as the first D/A output, containing the first 11 signal samples, `data(:,2)` as the second output, containing the next 11 signal samples, and so on.

You want to rebuffer this signal from the acquired frame size of 11 to a frame size of 4 with an underlap of 2. To do this, you will repeatedly call `buffer` to operate on each successive input frame, using the `opt` parameter to maintain consistency in the underlap from one buffer to the next.

Set the buffer parameters. Specify a new frame size of 4 and an underlap of -2. Skip the first input element, `x(1)` by setting `opt` to 1. The carryover vector is empty initially.

```
n = 4;  
p = -2;  
opt = 1;  
z = [];
```

Now repeatedly call `buffer`, each time passing in a new signal frame (column) from `data`. Overflow samples (returned in `z`) are carried over and prepended to the input in the subsequent call to `buffer`.

```
for i = 1:size(data,2)  
    x = data(:,i);  
    [y,z,opt] = buffer([z';x],n,p,opt);  
end
```

Here's what happens during the first three iterations.

Iteration	Input frame [z;x]'	opt (input)	opt (output)	Output buffer (y)	Overflow (z)
i=1	[1:11]	1	2	$\begin{bmatrix} 1 & - \\ 2 & 8 \\ 3 & 9 \\ 4 & 10 \\ 5 & 11 \\ 6 & - \\ 7 & - \end{bmatrix}$ } skip } skip	[]
i=2	[12:22]	2	0	$\begin{bmatrix} 12 \\ 13 \\ 14 \\ 15 \\ 16 \\ 17 \\ 18 \\ 19 \end{bmatrix}$ } skip } skip	[20 21 22]
i=3	[20 21 22 23:33]	0	0	$\begin{bmatrix} - & - \\ 20 & 26 \\ 21 & 27 \\ 22 & 28 \\ 23 & 29 \\ 24 & 30 \\ 25 & 31 \end{bmatrix}$ } skip } skip	[32 33]

The size of the output matrix, y, can vary by a single column from one iteration to the next. This is typical for buffering operations with overlap or underlap.

Diagnostics

Error messages are displayed when $p \geq n$ or $\text{length}(\text{opt}) \neq \text{length}(p)$ in an overlapping buffer case:

Frame overlap P must be less than the buffer size N.

Initial conditions must be specified as a length-P vector.

Definitions

Continuous Buffering

In a continuous buffering operation, the vector input to the `buffer` function represents one frame in a sequence of frames that make up a discrete signal. These signal frames can originate in a frame-based data acquisition process, or within a frame-based algorithm like the FFT.

As an example, you might acquire data from an A/D card in frames of 64 samples. In the simplest case, you could rebuffer the data into frames of 16 samples; `buffer` with `n = 16` creates a buffer of four frames from each 64-element input frame. The result is that the signal of frame size 64 has been converted to a signal of frame size 16; no samples were added or removed.

In the general case where the original signal frame size, L , is not equally divisible by the new frame size, n , the overflow from the last frame needs to be captured and recycled into the following buffer. You can do this by iteratively calling `buffer` on input x with the two-output-argument syntax:

```
[y,z] = buffer([z;x],n)    % x is a column vector.
[y,z] = buffer([z,x],n)   % x is a row vector.
```

This simply captures any buffer overflow in z , and prepends the data to the subsequent input in the next call to `buffer`. Again, the input signal, x , of frame size L , has been converted to a signal of frame size n without any insertion or deletion of samples.

Note that continuous buffering cannot be done with the single-output syntax `y = buffer(...)`, because the last frame of y in this case is zero padded, which adds new samples to the signal.

Continuous buffering in the presence of overlap and underlap is handled with the `opt` parameter, which is used as both an input and output to `buffer`. The following two examples demonstrate how the `opt` parameter should be used.

See Also

`reshape`

Introduced before R2006a

buttap

Butterworth filter prototype

Syntax

`[z,p,k] = buttap(n)`

Description

`[z,p,k] = buttap(n)` returns the poles and gain of an order n Butterworth analog lowpass filter prototype. The function returns the poles in the length n column vector p and the gain in scalar k . z is an empty matrix because there are no zeros. The transfer function is

$$H(s) = \frac{z(s)}{p(s)} = \frac{k}{(s - p(1))(s - p(2)) \cdots (s - p(n))}$$

Butterworth filters are characterized by a magnitude response that is maximally flat in the passband and monotonic overall. In the lowpass case, the first $2n-1$ derivatives of the squared magnitude response are zero at $\omega = 0$. The squared magnitude response function is

$$|H(\omega)|^2 = \frac{1}{1 + (\omega / \omega_0)^{2n}}$$

corresponding to a transfer function with poles equally spaced around a circle in the left half plane. The magnitude response at the cutoff angular frequency ω_0 is always $1/\sqrt{2}$ regardless of the filter order. `buttap` sets ω_0 to 1 for a normalized result.

Examples

Frequency Response of a Butterworth Analog Filter

Design a 9th-order Butterworth analog lowpass filter. Display its magnitude and phase responses.

```
[z,p,k] = buttap(9);           % Butterworth filter prototype
[num,den] = zp2tf(z,p,k);     % Convert to transfer function form
freqs(num,den)                % Frequency response of analog filter
```

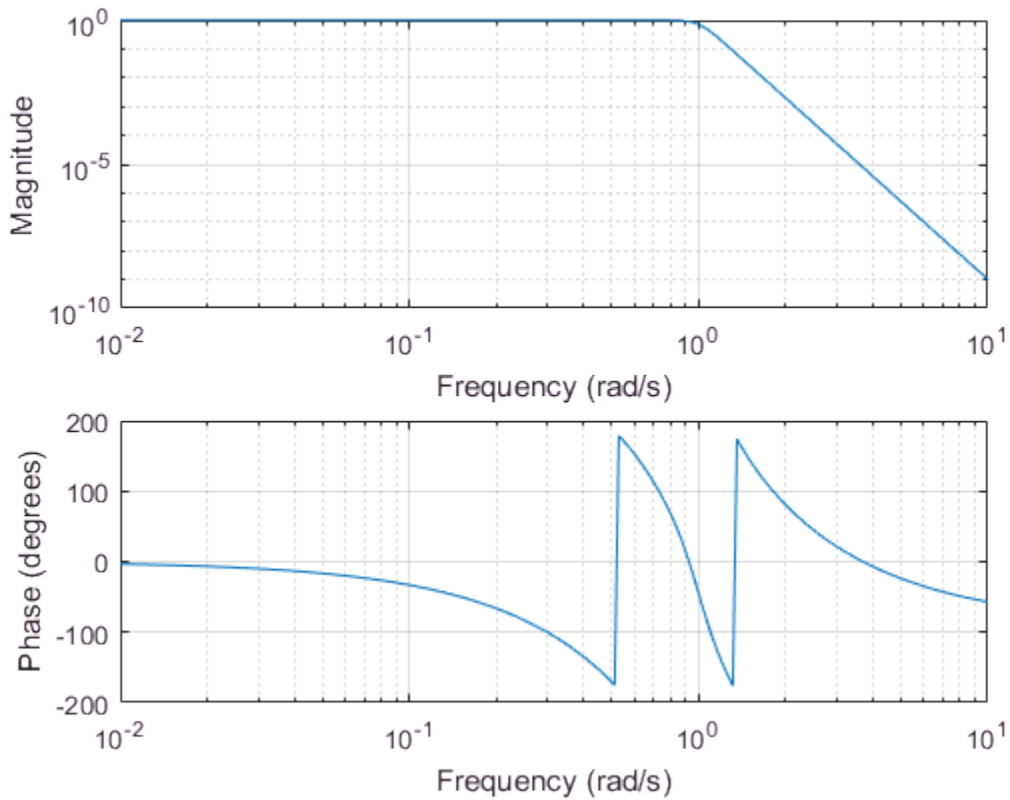

Algorithms

```
z = [];
p = exp(sqrt(-1)*(pi*(1:2:2*n-1)/(2*n)+pi/2)).';
k = real(prod(-p));
```

References

- [1] Parks, T. W., and C. S. Burrus. *Digital Filter Design*. New York: John Wiley & Sons, 1987, chap.7.

Extended Capabilities

C/C++ Code Generation

Generate C and C++ code using MATLAB® Coder™.

Usage notes and limitations:

Filter order must be a constant. Expressions or variables are allowed if their values do not change.

See Also

besselap | butter | cheb1ap | cheb2ap | ellipap

Introduced before R2006a

butter

Butterworth filter design

Syntax

```
[b,a] = butter(n,Wn)
[b,a] = butter(n,Wn,ftype)

[z,p,k] = butter( ___ )
[A,B,C,D] = butter( ___ )

[ ___ ] = butter( ___, 's' )
```

Description

`[b,a] = butter(n,Wn)` returns the transfer function coefficients of an n th-order lowpass digital Butterworth filter with normalized cutoff frequency Wn .

`[b,a] = butter(n,Wn,ftype)` designs a lowpass, highpass, bandpass, or bandstop Butterworth filter, depending on the value of `ftype` and the number of elements of Wn . The resulting bandpass and bandstop designs are of order $2n$.

Note: See “Limitations” on page 1-100 for information about numerical issues that affect forming the transfer function.

`[z,p,k] = butter(___)` designs a lowpass, highpass, bandpass, or bandstop digital Butterworth filter and returns its zeros, poles, and gain. This syntax can include any of the input arguments in previous syntaxes.

`[A,B,C,D] = butter(___)` designs a lowpass, highpass, bandpass, or bandstop digital Butterworth filter and returns the matrices that specify its state-space representation.

`[___] = butter(___, 's')` designs a lowpass, highpass, bandpass, or bandstop analog Butterworth filter with cutoff angular frequency Wn .

Examples

Lowpass Butterworth Transfer Function

Design a 6th-order lowpass Butterworth filter with a cutoff frequency of 300 Hz, which, for data sampled at 1000 Hz, corresponds to 0.6π rad/sample. Plot its magnitude and phase responses. Use it to filter a 1000-sample random signal.

```
fc = 300;  
fs = 1000;
```

```
[b,a] = butter(6,fc/(fs/2));  
freqz(b,a)
```

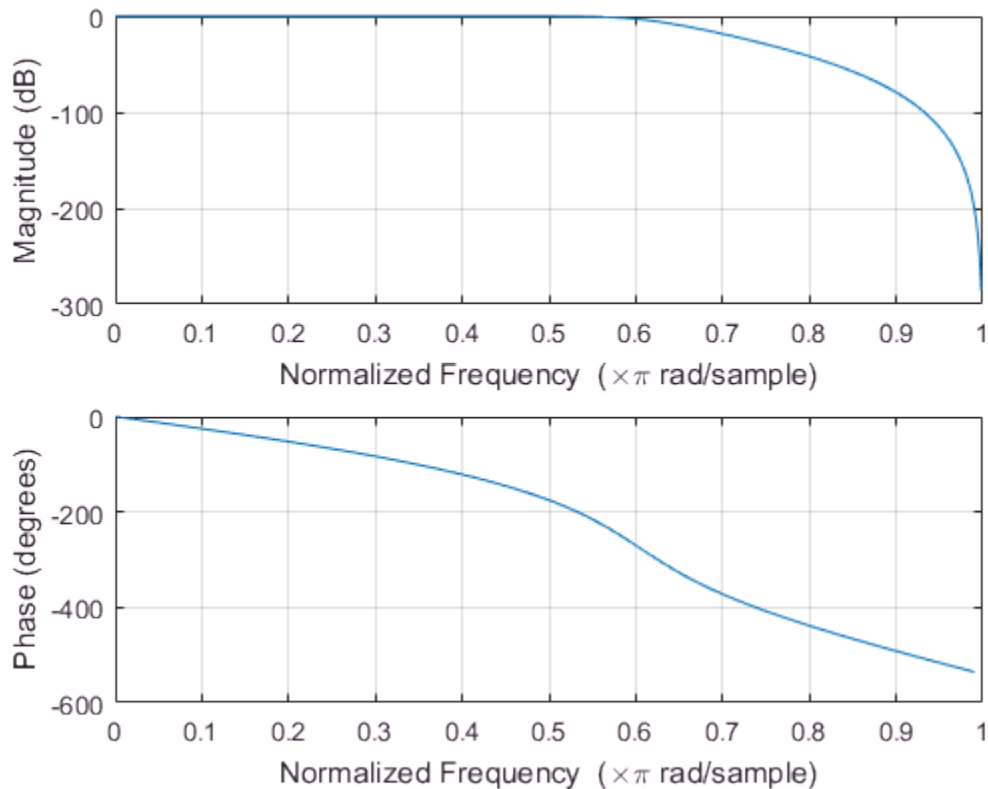

```
dataIn = randn(1000,1);  
dataOut = filter(b,a,dataIn);
```

Bandstop Butterworth Filter

Design a 6th-order Butterworth bandstop filter with normalized edge frequencies of 0.2π and 0.6π rad/sample. Plot its magnitude and phase responses. Use it to filter random data.

```
[b,a] = butter(3,[0.2 0.6], 'stop');  
freqz(b,a)
```

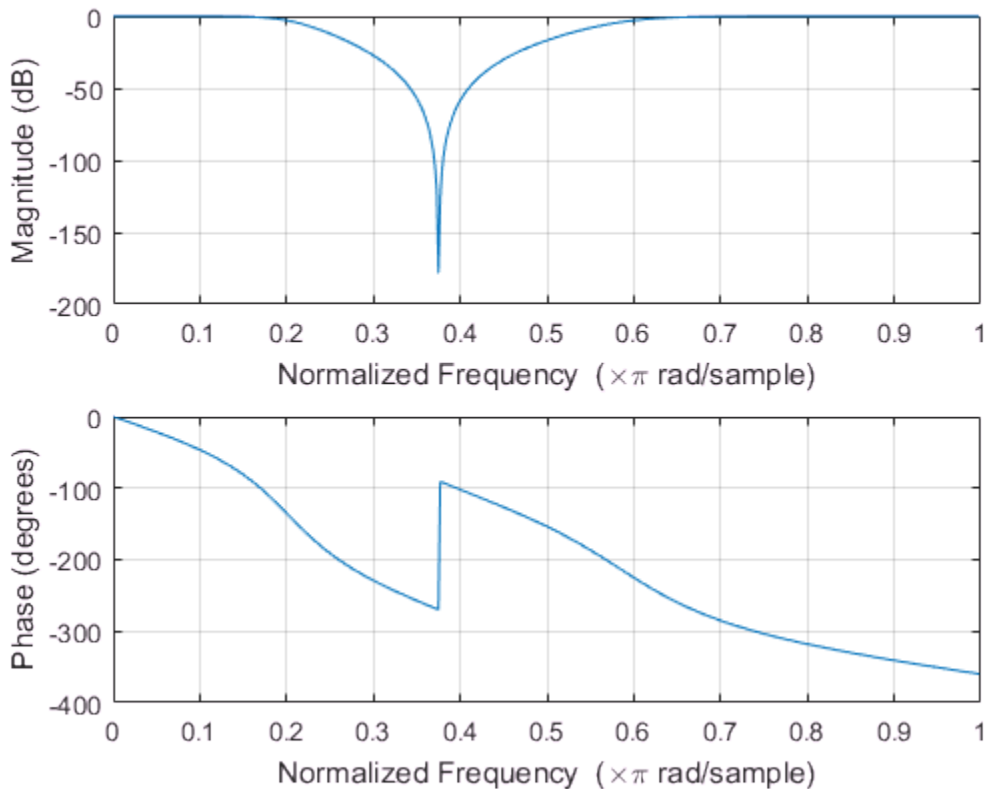

```
dataIn = randn(1000,1);  
dataOut = filter(b,a,dataIn);
```

Highpass Butterworth Filter

Design a 9th-order highpass Butterworth filter. Specify a cutoff frequency of 300 Hz, which, for data sampled at 1000 Hz, corresponds to 0.6π rad/sample. Plot the magnitude and phase responses. Convert the zeros, poles, and gain to second-order sections for use by `fvtool`.

```
[z,p,k] = butter(9,300/500,'high');  
sos = zp2sos(z,p,k);  
fvtool(sos,'Analysis','freq')
```

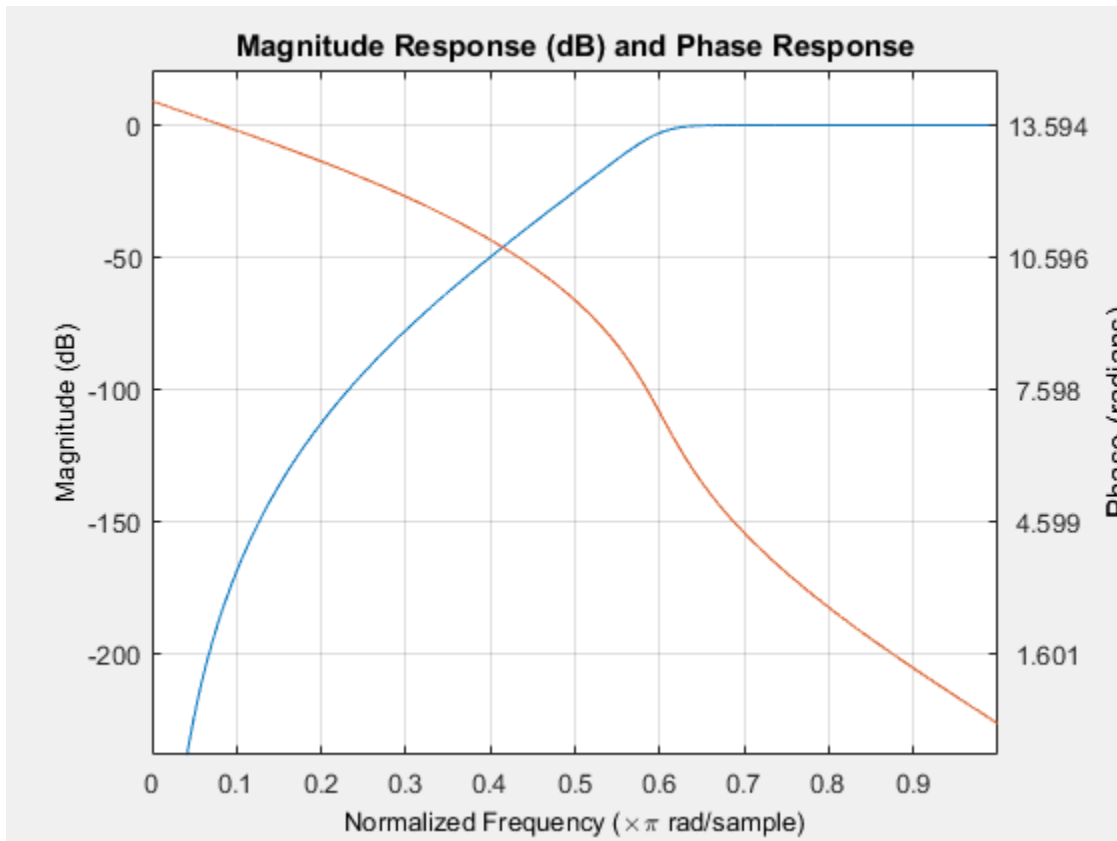

Bandpass Butterworth Filter

Design a 20th-order Butterworth bandpass filter with a lower cutoff frequency of 500 Hz and a higher cutoff frequency of 560 Hz. Specify a sample rate of 1500 Hz. Use the state-space representation. Design an identical filter using `designfilt`.

```
[A,B,C,D] = butter(10,[500 560]/750);  
d = designfilt('bandpassiir','FilterOrder',20, ...  
    'HalfPowerFrequency1',500,'HalfPowerFrequency2',560, ...  
    'SampleRate',1500);
```

Convert the state-space representation to second-order sections. Visualize the frequency responses using `fvtool`.

```
sos = ss2sos(A,B,C,D);  
fvt = fvtool(sos,d,'Fs',1500);  
legend(fvt,'butter','designfilt')
```

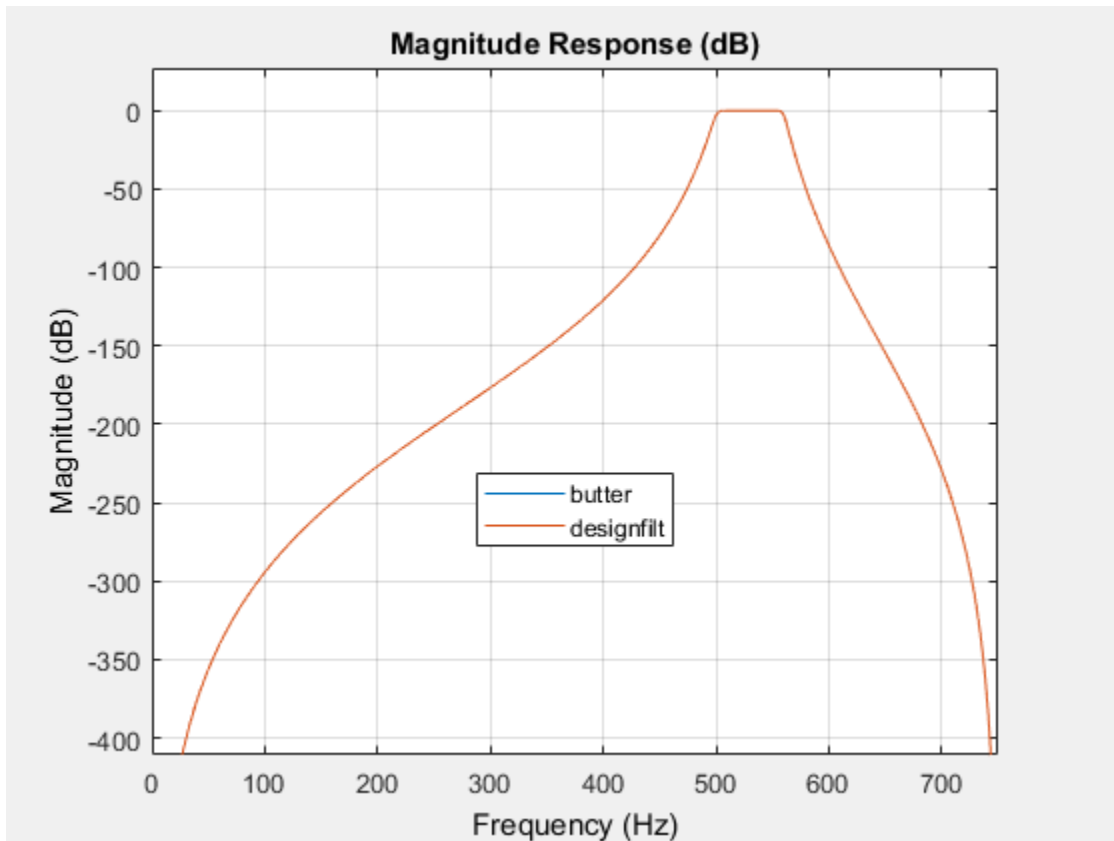

Comparison of Analog IIR Lowpass Filters

Design a 5th-order analog Butterworth lowpass filter with a cutoff frequency of 2 GHz.

Multiply by 2π to convert the frequency to radians per second. Compute the frequency response of the filter at 4096 points.

```
n = 5;
f = 2e9;

[zb,pb,kb] = butter(n,2*pi*f,'s');
[bb,ab] = zp2tf(zb,pb,kb);
[hb,wb] = freqs(bb,ab,4096);
```

Design a 5th-order Chebyshev Type I filter with the same edge frequency and 3 dB of passband ripple. Compute its frequency response.

```
[z1,p1,k1] = cheby1(n,3,2*pi*f,'s');  
[b1,a1] = zp2tf(z1,p1,k1);  
[h1,w1] = freqs(b1,a1,4096);
```

Design a 5th-order Chebyshev Type II filter with the same edge frequency and 30 dB of stopband attenuation. Compute its frequency response.

```
[z2,p2,k2] = cheby2(n,30,2*pi*f,'s');  
[b2,a2] = zp2tf(z2,p2,k2);  
[h2,w2] = freqs(b2,a2,4096);
```

Design a 5th-order elliptic filter with the same edge frequency, 3 dB of passband ripple, and 30 dB of stopband attenuation. Compute its frequency response.

```
[ze,pe,ke] = ellip(n,3,30,2*pi*f,'s');  
[be,ae] = zp2tf(ze,pe,ke);  
[he,we] = freqs(be,ae,4096);
```

Plot the attenuation in decibels. Express the frequency in gigahertz. Compare the filters.

```
plot(wb/(2e9*pi),mag2db(abs(hb)))  
hold on  
plot(w1/(2e9*pi),mag2db(abs(h1)))  
plot(w2/(2e9*pi),mag2db(abs(h2)))  
plot(we/(2e9*pi),mag2db(abs(he)))  
axis([0 4 -40 5])  
grid  
xlabel('Frequency (GHz)')  
ylabel('Attenuation (dB)')  
legend('butter','cheby1','cheby2','ellip')
```

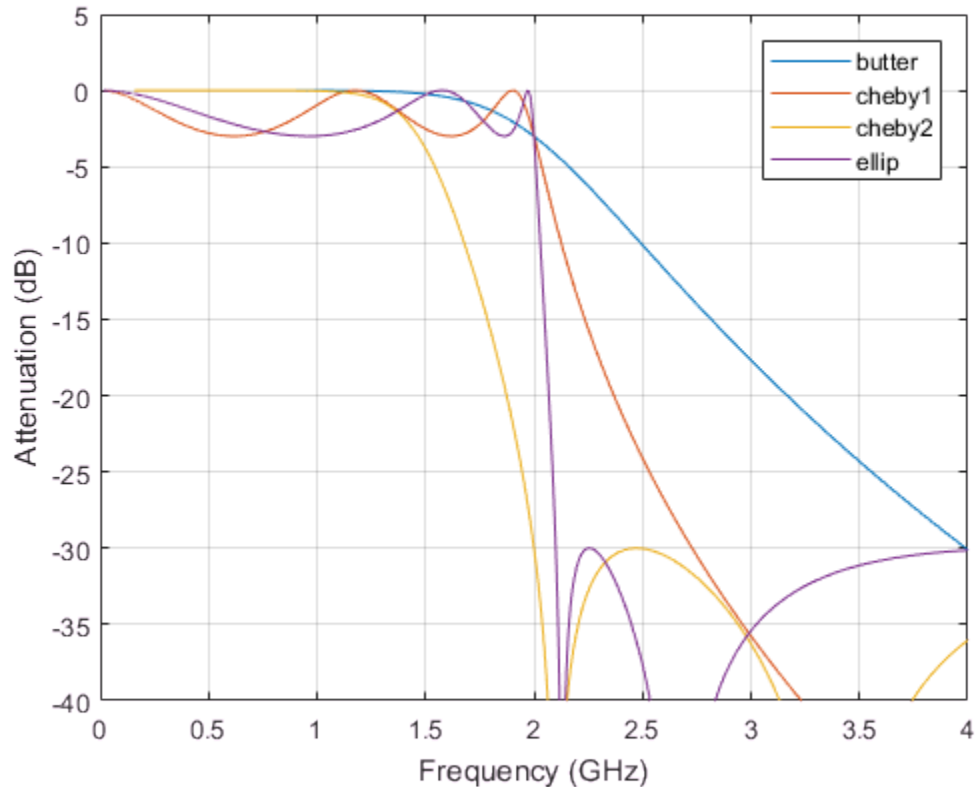

The Butterworth and Chebyshev Type II filters have flat passbands and wide transition bands. The Chebyshev Type I and elliptic filters roll off faster but have passband ripple. The frequency input to the Chebyshev Type II design function sets the beginning of the stopband rather than the end of the passband.

Input Arguments

n — Filter order
integer scalar

Filter order, specified as an integer scalar.

Data Types: double

Wn — Cutoff frequency

scalar | two-element vector

Cutoff frequency, specified as a scalar or a two-element vector. The cutoff frequency is the frequency at which the magnitude response of the filter is $1/\sqrt{2}$.

- If **Wn** is scalar, then `butter` designs a lowpass or highpass filter with cutoff frequency **Wn**.

If **Wn** is the two-element vector `[w1 w2]`, where $w1 < w2$, then `butter` designs a bandpass or bandstop filter with lower cutoff frequency **w1** and higher cutoff frequency **w2**.

- For digital filters, the cutoff frequencies must lie between 0 and 1, where 1 corresponds to the Nyquist rate—half the sample rate or π rad/sample.

For analog filters, the cutoff frequencies must be expressed in radians per second and can take on any positive value.

Data Types: double

ftype — Filter type

'low' | 'bandpass' | 'high' | 'stop'

Filter type, specified as one of the following:

- 'low' specifies a lowpass filter with cutoff frequency **Wn**. 'low' is the default for scalar **Wn**.
- 'high' specifies a highpass filter with cutoff frequency **Wn**.
- 'bandpass' specifies a bandpass filter of order $2n$ if **Wn** is a two-element vector. 'bandpass' is the default when **Wn** has two elements.
- 'stop' specifies a bandstop filter of order $2n$ if **Wn** is a two-element vector.

Data Types: char

Output Arguments

b, a — Transfer function coefficients

row vectors

Transfer function coefficients of the filter, returned as row vectors of length $n + 1$ for lowpass and highpass filters and $2n + 1$ for bandpass and bandstop filters.

- For digital filters, the transfer function is expressed in terms of **b** and **a** as

$$H(z) = \frac{B(z)}{A(z)} = \frac{b(1) + b(2)z^{-1} + \dots + b(n+1)z^{-n}}{a(1) + a(2)z^{-1} + \dots + a(n+1)z^{-n}}.$$

- For analog filters, the transfer function is expressed in terms of **b** and **a** as

$$H(s) = \frac{B(s)}{A(s)} = \frac{b(1)s^n + b(2)s^{n-1} + \dots + b(n+1)}{a(1)s^n + a(2)s^{n-1} + \dots + a(n+1)}.$$

Data Types: double

z, p, k — Zeros, poles, and gain

column vectors, scalar

Zeros, poles, and gain of the filter, returned as two column vectors of length n ($2n$ for bandpass and bandstop designs) and a scalar.

- For digital filters, the transfer function is expressed in terms of **z**, **p**, and **k** as

$$H(z) = k \frac{(1 - z(1)z^{-1})(1 - z(2)z^{-1}) \dots (1 - z(n)z^{-1})}{(1 - p(1)z^{-1})(1 - p(2)z^{-1}) \dots (1 - p(n)z^{-1})}.$$

- For analog filters, the transfer function is expressed in terms of **z**, **p**, and **k** as

$$H(s) = k \frac{(s - z(1))(s - z(2)) \dots (s - z(n))}{(s - p(1))(s - p(2)) \dots (s - p(n))}.$$

Data Types: double

A, B, C, D — State-space matrices

matrices

State-space representation of the filter, returned as matrices. If $m = n$ for lowpass and highpass designs and $m = 2n$ for bandpass and bandstop filters, then **A** is $m \times m$, **B** is $m \times 1$, **C** is $1 \times m$, and **D** is 1×1 .

- For digital filters, the state-space matrices relate the state vector x , the input u , and the output y through

$$\begin{aligned}x(k+1) &= A x(k) + B u(k) \\ y(k) &= C x(k) + D u(k).\end{aligned}$$

- For analog filters, the state-space matrices relate the state vector x , the input u , and the output y through

$$\begin{aligned}\dot{x} &= A x + B u \\ y &= C x + D u.\end{aligned}$$

Data Types: double

Definitions

Limitations

Numerical Instability of Transfer Function Syntax

In general, use the $[z, p, k]$ syntax to design IIR filters. To analyze or implement your filter, you can then use the $[z, p, k]$ output with `zp2sos`. If you design the filter using the $[b, a]$ syntax, you might encounter numerical problems. These problems are due to round-off errors and can occur for n as low as 4. The following example illustrates this limitation.

```
n = 6;
Wn = [2.5e6 29e6]/500e6;
ftype = 'bandpass';

% Transfer Function design
[b,a] = butter(n,Wn,ftype);      % This is an unstable filter

% Zero-Pole-Gain design
[z,p,k] = butter(n,Wn,ftype);
sos = zp2sos(z,p,k);

% Display and compare results
hfv = fvtool(b,a,sos,'FrequencyScale','log');
legend(hfv,'TF Design','ZPK Design')
```

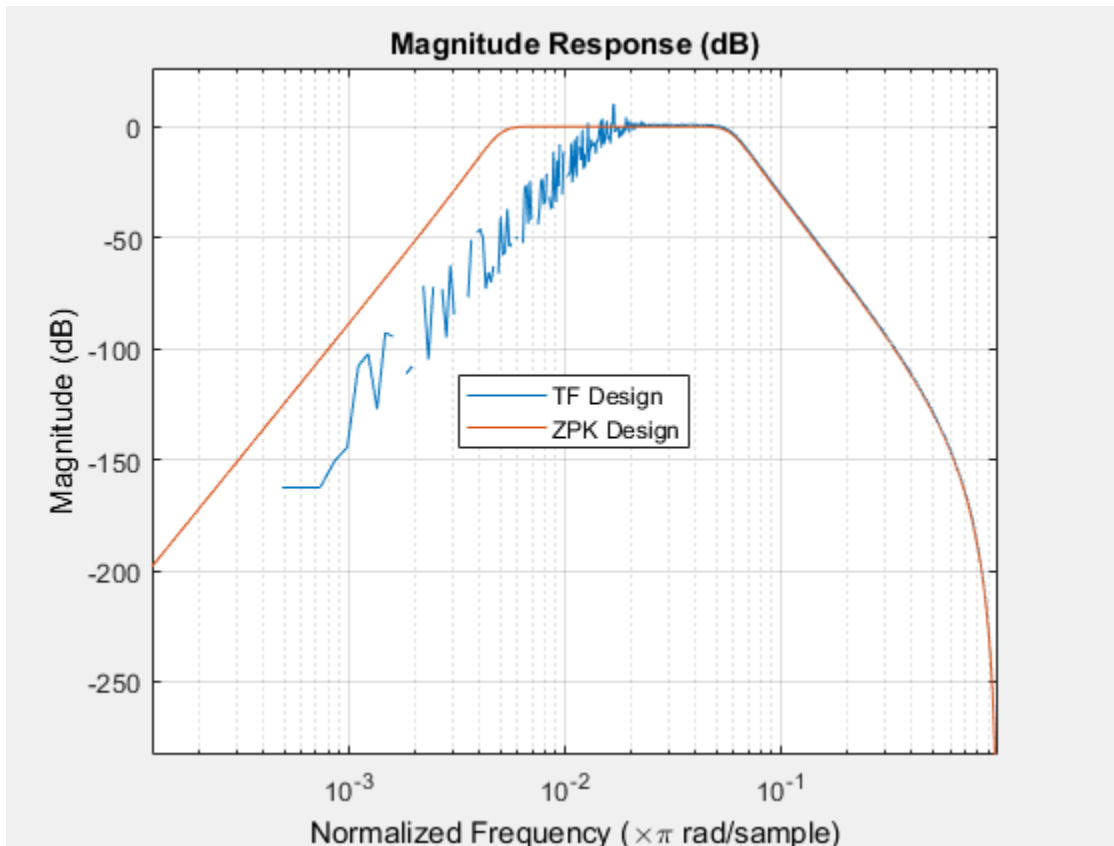

Algorithms

Butterworth filters have a magnitude response that is maximally flat in the passband and monotonic overall. This smoothness comes at the price of decreased rolloff steepness. Elliptic and Chebyshev filters generally provide steeper rolloff for a given filter order.

`butter` uses a five-step algorithm:

- 1 It finds the lowpass analog prototype poles, zeros, and gain using the function `buttap`.
- 2 It converts the poles, zeros, and gain into state-space form.

- 3 If required, it uses a state-space transformation to convert the lowpass filter into a bandpass, highpass, or bandstop filter with the desired frequency constraints.
- 4 For digital filter design, it uses `bilinear` to convert the analog filter into a digital filter through a bilinear transformation with frequency prewarping. Careful frequency adjustment enables the analog filters and the digital filters to have the same frequency response magnitude at ω_n or at ω_1 and ω_2 .
- 5 It converts the state-space filter back to its transfer function or zero-pole-gain form, as required.

Extended Capabilities

C/C++ Code Generation

Generate C and C++ code using MATLAB® Coder™.

Usage notes and limitations:

Filter coefficients must be constants. Expressions or variables are allowed if their values do not change.

See Also

See Also

`besself` | `buttap` | `buttord` | `cheby1` | `cheby2` | `designfilt` | `ellip` | `filter` | `maxflat` | `sosfilt`

Introduced before R2006a

butterd

Butterworth filter order and cutoff frequency

Syntax

```
[n,Wn] = butterd(Wp,Ws,Rp,Rs)
[n,Wn] = butterd(Wp,Ws,Rp,Rs, 's')
```

Description

`butterd` calculates the minimum order of a digital or analog Butterworth filter required to meet a set of filter design specifications.

Digital Domain

`[n,Wn] = butterd(Wp,Ws,Rp,Rs)` returns the lowest order, `n`, of the digital Butterworth filter with no more than `Rp` dB of passband ripple and at least `Rs` dB of attenuation in the stopband. The scalar (or vector) of corresponding cutoff frequencies, `Wn`, is also returned. Use the output arguments `n` and `Wn` in `butter`.

Choose the input arguments to specify the stopband and passband according to the following table.

Description of Stopband and Passband Filter Parameters

Parameter	Description
<code>Wp</code>	Passband corner frequency <code>Wp</code> , the cutoff frequency, is a scalar or a two-element vector with values between 0 and 1, with 1 corresponding to the normalized Nyquist frequency, π radians per sample.
<code>Ws</code>	Stopband corner frequency <code>Ws</code> , is a scalar or a two-element vector with values between 0 and 1, with 1 corresponding to the normalized Nyquist frequency.
<code>Rp</code>	Passband ripple in decibels.
<code>Rs</code>	Stopband attenuation in decibels. This value is the number of decibels the stopband is down from the passband.

Use the following guide to specify filters of different types.

Filter Type Stopband and Passband Specifications

Filter Type	Stopband and Passband Conditions	Stopband	Passband
Lowpass	$W_p < W_s$, both scalars	$(W_s, 1)$	$(0, W_p)$
Highpass	$W_p > W_s$, both scalars	$(0, W_s)$	$(W_p, 1)$
Bandpass	The interval specified by W_s contains the one specified by W_p ($W_s(1) < W_p(1) < W_p(2) < W_s(2)$).	$(0, W_s(1))$ and $(W_s(2), 1)$	$(W_p(1), W_p(2))$
Bandstop	The interval specified by W_p contains the one specified by W_s ($W_p(1) < W_s(1) < W_s(2) < W_p(2)$).	$(W_s(1), W_s(2))$	$(0, W_p(1))$ and $(W_p(2), 1)$

If your filter specifications call for a bandpass or bandstop filter with unequal ripple in each of the passbands or stopbands, design separate lowpass and highpass filters according to the specifications in this table, and cascade the two filters together.

Analog Domain

`[n,Wn] = buttord(Wp,Ws,Rp,Rs, 's')` finds the minimum order n and cutoff frequencies Wn for an analog Butterworth filter. You specify the frequencies W_p and W_s similar those described in the Description of Stopband and Passband Filter Parameters table above, only in this case you specify the frequency in radians per second, and the passband or the stopband can be infinite.

Use `buttord` for lowpass, highpass, bandpass, and bandstop filters as described in the Filter Type Stopband and Passband Specifications table above.

Examples

Lowpass Butterworth Filter

For data sampled at 1000 Hz, design a lowpass filter with no more than 3 dB of ripple in a passband from 0 to 40 Hz, and at least 60 dB of attenuation in the stopband. Find the filter order and cutoff frequency.

`Wp = 40/500;`

```
Ws = 150/500;
```

```
[n,Wn] = buttord(Wp,Ws,3,60)
```

```
n = 5
```

```
Wn = 0.0810
```

Specify the filter in terms of second-order sections and plot the frequency response.

```
[z,p,k] = butter(n,Wn);
```

```
sos = zp2sos(z,p,k);
```

```
freqz(sos,512,1000)
```

```
title(sprintf('n = %d Butterworth Lowpass Filter',n))
```

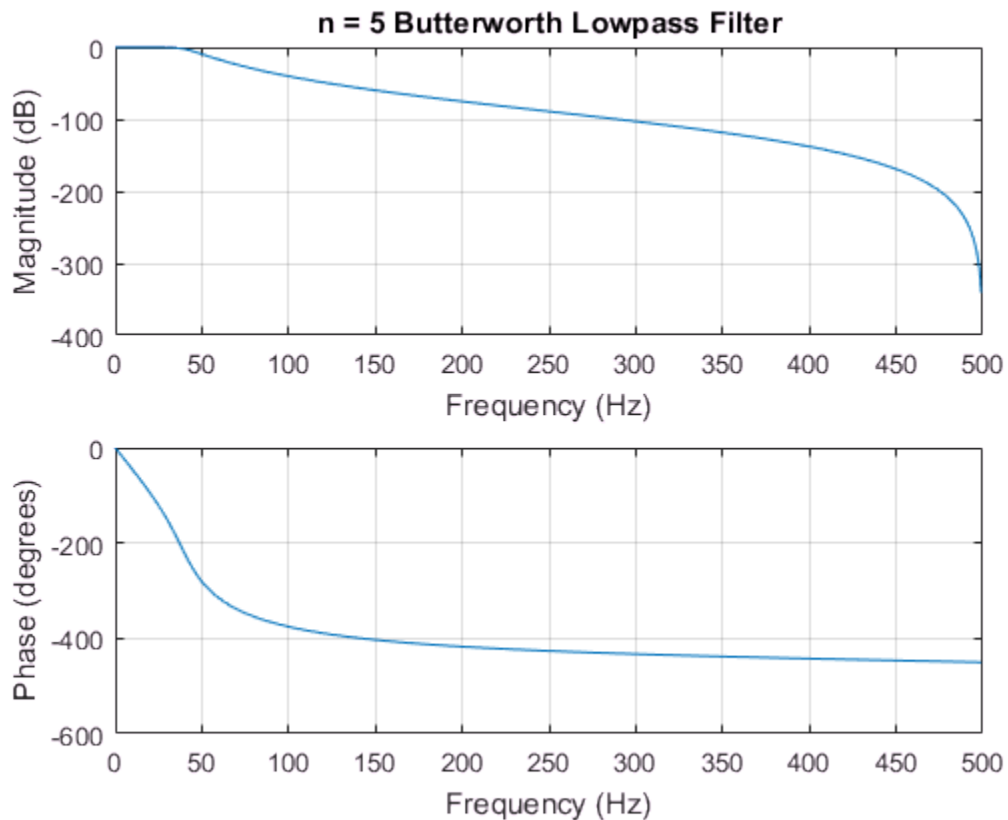

Bandpass Butterworth Filter

Design a bandpass filter with a passband from 100 to 200 Hz with at most 3 dB of passband ripple and at least 40 dB attenuation in the stopbands. Specify a sample rate of 1 kHz. Have the stopbands be 50 Hz wide on both sides of the passband. Find the filter order and cutoff frequencies.

```
Wp = [100 200]/500;  
Ws = [50 250]/500;  
Rp = 3;  
Rs = 40;  
[n,Wn] = buttord(Wp,Ws,Rp,Rs)
```

```
n = 8
```

```
Wn =
```

```
0.1951    0.4080
```

Specify the filter in terms of second-order sections and plot the frequency response.

```
[z,p,k] = butter(n,Wn);  
sos = zp2sos(z,p,k);  
  
freqz(sos,128,1000)  
title(sprintf('n = %d Butterworth Bandpass Filter',n))
```

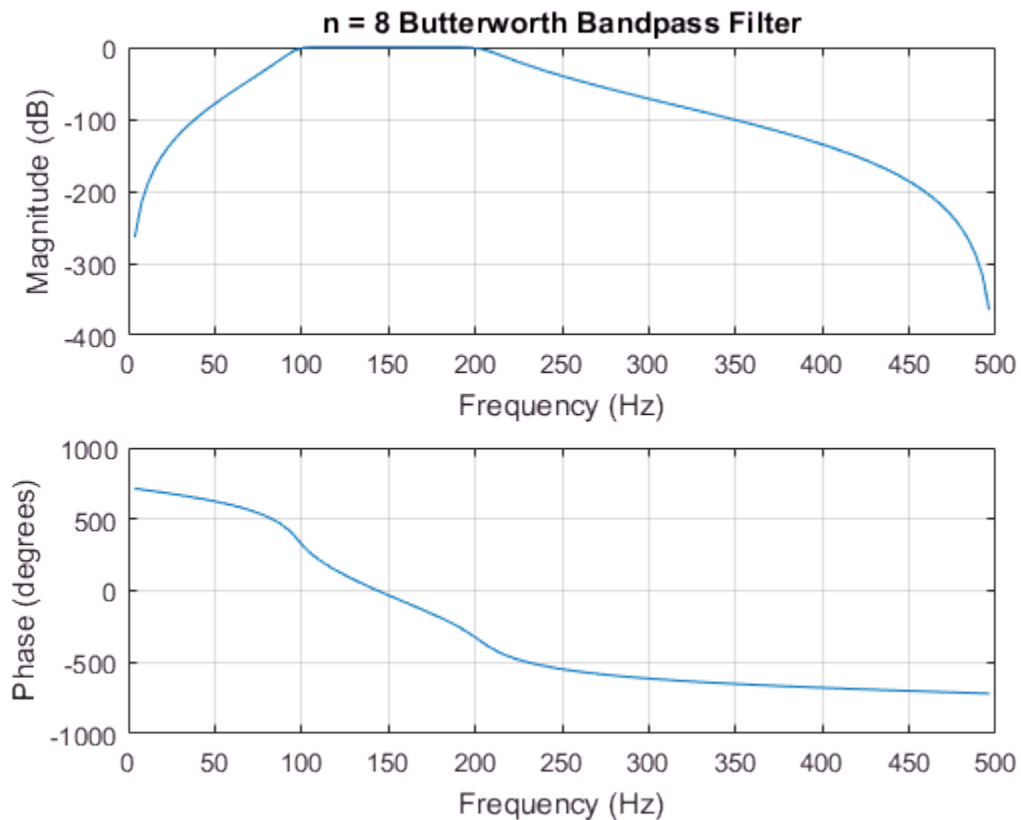
Algorithms

`butford`'s order prediction formula is described in [1]. It operates in the analog domain for both analog and digital cases. For the digital case, it converts the frequency parameters to the s -domain before estimating the order and natural frequency, and then converts back to the z -domain.

`butford` initially develops a lowpass filter prototype by transforming the passband frequencies of the desired filter to 1 rad/s (for lowpass and highpass filters) and to -1 and 1 rad/s (for bandpass and bandstop filters). It then computes the minimum order required for a lowpass filter to meet the stopband specification.

References

- [1] Rabiner, Lawrence R., and Bernard Gold. *Theory and Application of Digital Signal Processing*. Englewood Cliffs, NJ: Prentice-Hall, 1975.

Extended Capabilities

C/C++ Code Generation

Generate C and C++ code using MATLAB® Coder™.

Usage notes and limitations:

All inputs must be constants. Expressions or variables are allowed if their values do not change.

See Also

butter | cheb1ord | cheb2ord | ellipord | kaiserord

Introduced before R2006a

cceps

Complex cepstral analysis

Syntax

```
xhat = cceps(x)
[xhat,nd] = cceps(x)
[xhat,nd,xhat1] = cceps(x)
[...] = cceps(x,n)
```

Description

Cepstral analysis is a nonlinear signal processing technique that is applied most commonly in speech processing and homomorphic filtering [1].

Note cceps only works on real data.

`xhat = cceps(x)` returns the complex cepstrum of the real data sequence `x` using the Fourier transform. The input is altered, by the application of a linear phase term, to have no phase discontinuity at $\pm\pi$ radians. That is, it is circularly shifted (after zero padding) by some samples, if necessary, to have zero phase at π radians.

`[xhat,nd] = cceps(x)` returns the number of samples `nd` of (circular) delay added to `x` prior to finding the complex cepstrum.

`[xhat,nd,xhat1] = cceps(x)` returns a second complex cepstrum, `xhat1`, computed using an alternative factorization algorithm [1][2]. This method can be applied only to finite-duration signals. See the Algorithm section below for a comparison of the Fourier and factorization methods of computing the complex cepstrum.

`[...] = cceps(x,n)` zero pads `x` to length `n` and returns the length `n` complex cepstrum of `x`.

Examples

Using `cceps` to show an echo

This example uses `cceps` to show an echo. Generate a sine of frequency 45 Hz, sampled at 100 Hz. Add an echo with half the amplitude and 0.2 s later. Compute the complex cepstrum of the signal. Notice the echo at 0.2 s.

```
Fs = 100;
t = 0:1/Fs:1.27;

s1 = sin(2*pi*45*t);
s2 = s1 + 0.5*[zeros(1,20) s1(1:108)];

c = cceps(s2);

plot(t,c)
xlabel('Time (s)')
title('Complex cepstrum')
```

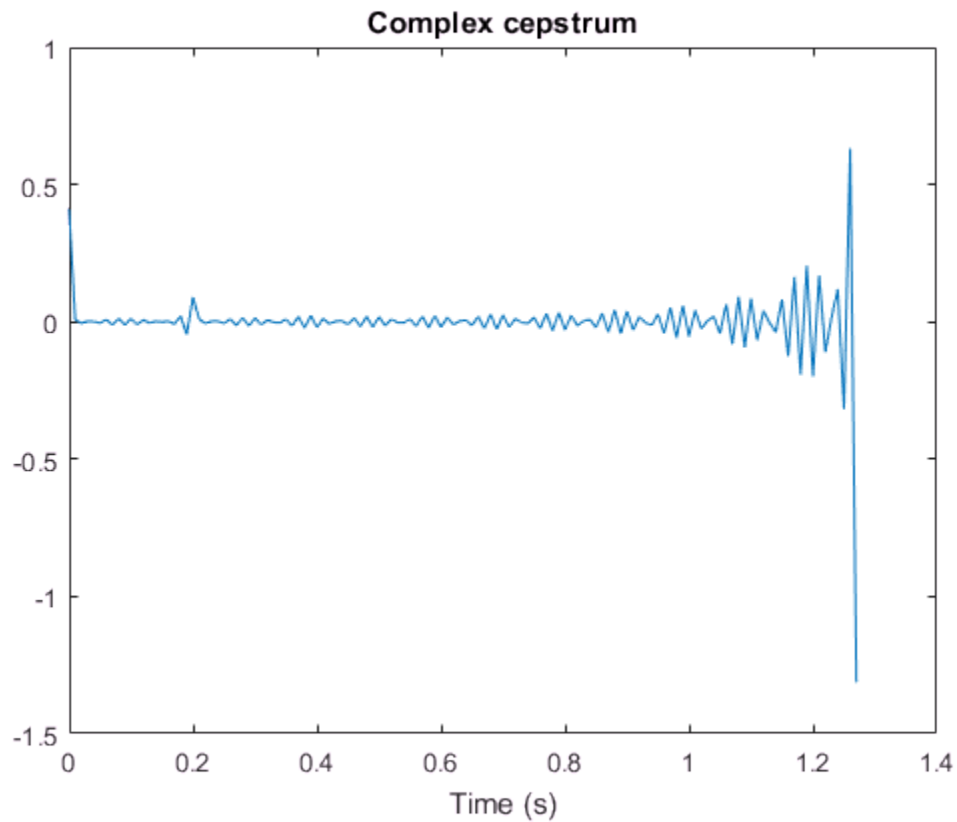

Algorithms

`cceps` is an implementation of algorithm 7.1 in [3]. A lengthy Fortran program reduces to these three lines of MATLAB code, which compose the core of `cceps`:

```
h = fft(x);  
logh = log(abs(h)) + sqrt(-1)*rcunwrap(angle(h));  
y = real(ifft(logh));
```

Note `rcunwrap` in the above code segment is a special version of `unwrap` that subtracts a straight line from the phase. `rcunwrap` is a local function within `cceps` and is not available for use from the MATLAB command line.

The following table lists the pros and cons of the Fourier and factorization algorithms.

Algorithm	Pros	Cons
Fourier	Can be used for any signal.	Requires phase unwrapping. Output is aliased.
Factorization	Does not require phase unwrapping. No aliasing	Can be used only for short duration signals. Input signal must have an all-zero Z-transform with no zeros on the unit circle.

In general, you cannot use the results of these two algorithms to verify each other. You can use them to verify each other only when the first element of the input data is positive, the Z-transform of the data sequence has only zeros, all of these zeros are inside the unit circle, and the input data sequence is long (or padded with zeros).

References

- [1] Oppenheim, Alan V., Ronald W. Schafer, and John R. Buck. *Discrete-Time Signal Processing*. Upper Saddle River, NJ: Prentice Hall, 1999, pp.788–789.
- [2] Steiglitz, K., and B. Dickinson. “Computation of the Complex Cepstrum by Factorization of the Z-transform.” *Proceedings of the 1977 IEEE International Conference on Acoustics, Speech and Signal Processing*, pp.723–726.
- [3] Digital Signal Processing Committee of the IEEE Acoustics, Speech, and Signal Processing Society, eds. *Programs for Digital Signal Processing*. New York: IEEE Press, 1979.

See Also

`icceps` | `hilbert` | `rceps` | `unwrap`

Introduced before R2006a

cconv

Modulo-N circular convolution

Syntax

```
c = cconv(a,b,n)
c = cconv(gpuArrayA,gpuArrayB,n)
```

Description

Circular convolution is used to convolve two discrete Fourier transform (DFT) sequences. For long sequences, circular convolution can be faster than linear convolution.

`c = cconv(a,b,n)` circularly convolves vectors `a` and `b`. `n` is the length of the resulting vector. If you omit `n`, it defaults to `length(a)+length(b)-1`. When `n = length(a)+length(b)-1`, the circular convolution is equivalent to the linear convolution computed with `conv`. You can also use `cconv` to compute the circular cross-correlation of two sequences.

`c = cconv(gpuArrayA,gpuArrayB,n)` returns the circular convolution of the input vectors of class `gpuArray`. See “Establish Arrays on a GPU” (Parallel Computing Toolbox) for details on `gpuArray` objects. Using `cconv` with `gpuArray` objects requires Parallel Computing Toolbox™ software and a CUDA-enabled NVIDIA GPU with compute capability 1.3 or above. See <http://www.mathworks.com/products/parallel-computing/requirements.html> for details. The output vector, `c`, is a `gpuArray` object. See “Circular Convolution Using the GPU” on page 1-117 for an example of using the GPU to compute the circular convolution.

Examples

Circular Convolution

Generate two vectors and compute their modulo-4 circular convolution.

```
a = [2 1 2 1];
```

```
b = [1 2 3 4];
c = cconv(a,b,4)

c =

    14    16    14    16
```

Circular Convolution and Linear Convolution

Generate two signals of different lengths. Compare their circular convolution and their linear convolution. Use the default value for *n*.

```
a = [1 2 -1 1];
b = [1 1 2 1 2 2 1 1];

c = cconv(a,b);           % Circular convolution
cref = conv(a,b);        % Linear convolution

dif = norm(c-cref)

dif = 9.7422e-16
```

The resulting norm is virtually zero, which shows that the two convolutions produce the same result to machine precision.

Circular Cross-Correlation

Generate two complex sequences. Use `cconv` to compute their circular cross-correlation. Flip and conjugate the second operand to comply with the definition of cross-correlation. Specify an output vector length of 7.

```
a = [1 2 2 1]+1i;
b = [1 3 4 1]-2*1i;
c = cconv(a,conj(flip1r(b)),7);
```

Compare the result to the cross-correlation computed using `xcorr`.

```
cref = xcorr(a,b);
dif = norm(c-cref)

dif = 3.3565e-15
```

Circular Convolution with Varying Output Length

Generate two signals: a five-sample triangular waveform and a first-order FIR filter with response $H(z) = 1 - z^{-1}$.

```
x1 = conv([1 1 1],[1 1 1])
```

```
x1 =
```

```
    1    2    3    2    1
```

```
x2 = [-1 1]
```

```
x2 =
```

```
   -1    1
```

Compute their circular convolution with the default output length. The result is equivalent to the linear convolution of the two signals.

```
ccnv = cconv(x1,x2)
```

```
ccnv =
```

```
   -1.0000   -1.0000   -1.0000    1.0000    1.0000    1.0000
```

```
lcnv = conv(x1,x2)
```

```
lcnv =
```

```
   -1   -1   -1    1    1    1
```

The modulo-2 circular convolution is equivalent to splitting the linear convolution into two-element arrays and summing the arrays.

```
ccn2 = cconv(x1,x2,2)
```

```
ccn2 =
```

```
   -1    1
```

```
n1 = numel(lcnv);
mod2 = sum(reshape(lcnv,2,n1/2)')
mod2 =
    -1     1
```

Compute the modulo-3 circular convolution and compare it to the aliased linear convolution.

```
ccn3 = cconv(x1,x2,3)
ccn3 =
     0     0     0
```

```
mod3 = sum(reshape(lcnv,3,n1/3)')
mod3 =
     0     0     0
```

If the output length is smaller than the convolution length and does not divide it exactly, pad the convolution with zeros before adding.

```
c = 5;
z = zeros(c*ceil(n1/c),1);
z(1:n1) = lcnv;

ccnc = cconv(x1,x2,c)
ccnc =
    0.0000   -1.0000   -1.0000    1.0000    1.0000

modc = sum(reshape(z,c,numel(z)/c)')
modc =
```

```
0 -1 -1 1 1
```

If the output length is equal to or larger than the convolution length, pad the convolution and do not add.

```
d = 13;
z = zeros(d*ceil(nl/d),1);
z(1:nl) = lcnv;
```

```
ccnd = cconv(x1,x2,d)
```

```
ccnd =
```

```
-1.0000 -1.0000 -1.0000 1.0000 1.0000 1.0000 0.0000 -0.0000 0.0000
```

```
modd = z'
```

```
modd =
```

```
-1 -1 -1 1 1 1 0 0 0 0 0 0 0
```

Circular Convolution Using the GPU

The following example requires Parallel Computing Toolbox software and a CUDA-enabled NVIDIA GPU with compute capability 1.3 or above. See <http://www.mathworks.com/products/parallel-computing/requirements.html> for details.

Create two signals consisting of a 1 kHz sine wave in additive white Gaussian noise. The sample rate is 10 kHz

```
Fs = 1e4;
t = 0:1/Fs:10-(1/Fs);
x = cos(2*pi*1e3*t)+randn(size(t));
y = sin(2*pi*1e3*t)+randn(size(t));
```

Put `x` and `y` on the GPU using `gpuArray`. Obtain the circular convolution using the GPU.

```
x = gpuArray(x);
```

```
y = gpuArray(y);  
cirC = cconv(x,y,length(x)+length(y)-1);
```

Compare the result to the linear convolution of `x` and `y`.

```
linC = conv(x,y);  
norm(linC-cirC,2)
```

Return the circular convolution, `cirC`, to the MATLAB workspace using `gather`.

```
cirC = gather(cirC);
```

References

[1] Orfanidis, Sophocles J. *Introduction to Signal Processing*. Englewood Cliffs, NJ: Prentice-Hall, 1996, pp. 524–529.

Extended Capabilities

C/C++ Code Generation

Generate C and C++ code using MATLAB® Coder™.

See Also

See Also

`conv` | `xcorr`

Introduced in R2007a

cell2sos

Convert second-order sections cell array to matrix

Syntax

```
m = cell2sos(c)
```

Description

`m = cell2sos(c)` changes a 1-by- L cell array `c` consisting of 1-by-2 cell arrays into an L -by-6 second-order section matrix `m`. Matrix `m` takes the same form as the matrix generated by `tf2sos`. You can use `m = cell2sos(c)` to invert the results of `c = sos2cell(m)`.

`c` must be a cell array of the form

```
c = { {b1 a1} {b2 a2} ... {bL aL} }
```

where both b_i and a_i are row vectors of at most length 3, and $i = 1, 2, \dots, L$. The resulting matrix `m` is given by

```
m = [b1 a1;b2 a2; ... ;bL aL]
```

Examples

Second-Order Sections from Cell Array Input

Generate a cell array of 1-by-2 cell arrays of 1-by-3 row vectors. Convert it to a matrix of second-order sections.

```
c11 = {[3 6 7] [1 1 2]}
      {[1 4 5] [1 9 3]}
      {[2 7 1] [1 7 8]};
sos = cell2sos(c11)

sos =
```

3	6	7	1	1	2
1	4	5	1	9	3
2	7	1	1	7	8

See Also

`sos2cell` | `tf2sos`

Introduced before R2006a

cfirpm

Complex and nonlinear-phase equiripple FIR filter design

Syntax

```

b = cfirpm(n,f,@fresp)
b = cfirpm(n,f,@fresp,w)
b = cfirpm(n,f,a)
b = cfirpm(n,f,a,w)
b = cfirpm(...,'sym')
b = cfirpm(...,'skip_stage2')
b = cfirpm(...,'debug')
b = cfirpm(...,{lgrid})
[b,delta] = cfirpm(...)
[b,delta,opt] = cfirpm(...)

```

Description

`cfirpm` allows arbitrary frequency-domain constraints to be specified for the design of a possibly complex FIR filter. The Chebyshev (or minimax) filter error is optimized, producing equiripple FIR filter designs.

`b = cfirpm(n,f,@fresp)` returns a length $n+1$ FIR filter with the best approximation to the desired frequency response as returned by function `fresp`, which is called by its function handle (`@fresp`). `f` is a vector of frequency band edge pairs, specified in the range -1 and 1 , where 1 corresponds to the normalized Nyquist frequency. The frequencies must be in increasing order, and `f` must have even length. The frequency bands span `f(k)` to `f(k+1)` for `k` odd; the intervals `f(k+1)` to `f(k+2)` for `k` odd are “transition bands” or “don't care” regions during optimization.

Predefined `fresp` frequency response functions are included for a number of common filter designs, as described below. (See “Create Function Handle” (MATLAB) for more information on how to create a custom `fresp` function.) For all of the predefined frequency response functions, the symmetry option `'sym'` defaults to `'even'` if no negative frequencies are contained in `f` and `d = 0`; otherwise `'sym'` defaults to `'none'`. (See the `'sym'` option below for details.) For all of the predefined frequency response functions, `d` specifies a group-delay offset such that the filter response has a group delay

of $n/2+d$ in units of the sample interval. Negative values create less delay; positive values create more delay. By default $d = 0$:

- `@lowpass`, `@highpass`, `@allpass`, `@bandpass`, `@bandstop`

These functions share a common syntax, exemplified below by `@lowpass`.

`b = cfirpm(n,f,@lowpass,...)` and

`b = cfirpm(n,f,{@lowpass,d},...)` design a linear-phase ($n/2+d$ delay) filter.

Note: For `@bandpass` filters, the first element in the frequency vector must be less than or equal to zero and the last element must be greater than or equal to zero.

- `@multiband` designs a linear-phase frequency response filter with arbitrary band amplitudes.

`b = cfirpm(n,f,{@multiband,a},...)` and

`b = cfirpm(n,f,{@multiband,a,d},...)` specify vector `a` containing the desired amplitudes at the band edges in `f`. The desired amplitude at frequencies between pairs of points `f(k)` and `f(k+1)` for `k` odd is the line segment connecting the points `(f(k),a(k))` and `(f(k+1),a(k+1))`.

- `@differentiator` designs a linear-phase differentiator. For these designs, zero-frequency must be in a transition band, and band weighting is set to be inversely proportional to frequency.

`b = cfirpm(n,f,{@differentiator,fs},...)` and

`b = cfirpm(n,f,{@differentiator,fs,d},...)` specify the sample rate `fs` used to determine the slope of the differentiator response. If omitted, `fs` defaults to 1.

- `@hilbfilt` designs a linear-phase Hilbert transform filter response. For Hilbert designs, zero-frequency must be in a transition band.

`b = cfirpm(n,f,@hilbfilt,...)` and

`b = cfirpm(N,F,{@hilbfilt,d},...)` design a linear-phase ($n/2+d$ delay) Hilbert transform filter.

- `@invsinc` designs a linear-phase inverse-sinc filter response.

`b = cfirpm(n,f,{@invsinc,a},...)` and

$\mathbf{b} = \text{cfirpm}(n, \mathbf{f}, \{\text{@invsinc}, \mathbf{a}, \mathbf{d}\}, \dots)$ specify gain \mathbf{a} for the sinc function, computed as $\text{sinc}(\mathbf{a} * \mathbf{g})$, where \mathbf{g} contains the optimization grid frequencies normalized to the range $[-1, 1]$. By default, $\mathbf{a} = 1$. The group-delay offset is \mathbf{d} , such that the filter response will have a group delay of $N/2 + \mathbf{d}$ in units of the sample interval, where N is the filter order. Negative values create less delay and positive values create more delay. By default, $\mathbf{d} = 0$.

$\mathbf{b} = \text{cfirpm}(n, \mathbf{f}, \text{@fresp}, \mathbf{w})$ uses the real, nonnegative weights in vector \mathbf{w} to weight the fit in each frequency band. The length of \mathbf{w} is half the length of \mathbf{f} , so there is exactly one weight per band.

$\mathbf{b} = \text{cfirpm}(n, \mathbf{f}, \mathbf{a})$ is a synonym for $\mathbf{b} = \text{cfirpm}(n, \mathbf{f}, \{\text{@multiband}, \mathbf{a}\})$.

$\mathbf{b} = \text{cfirpm}(n, \mathbf{f}, \mathbf{a}, \mathbf{w})$ applies an optional set of positive weights, one per band, for use during optimization. If \mathbf{w} is not specified, the weights are set to unity.

$\mathbf{b} = \text{cfirpm}(\dots, \text{'sym'})$ imposes a symmetry constraint on the impulse response of the design, where *'sym'* may be one of the following:

- *'none'* indicates no symmetry constraint. This is the default if any negative band edge frequencies are passed, or if *fresp* does not supply a default.
- *'even'* indicates a real and even impulse response. This is the default for highpass, lowpass, allpass, bandpass, bandstop, inverse-sinc, and multiband designs.
- *'odd'* indicates a real and odd impulse response. This is the default for Hilbert and differentiator designs.
- *'real'* indicates conjugate symmetry for the frequency response

If any *'sym'* option other than *'none'* is specified, the band edges should be specified only over positive frequencies; the negative frequency region is filled in from symmetry. If a *'sym'* option is not specified, the *fresp* function is queried for a default setting. Any user-supplied *fresp* function should return a valid *'sym'* option when it is passed *'defaults'* as the filter order N .

$\mathbf{b} = \text{cfirpm}(\dots, \text{'skip_stage2'})$ disables the second-stage optimization algorithm, which executes only when *cfirpm* determines that an optimal solution has not been reached by the standard *firpm* error-exchange. Disabling this algorithm may increase the speed of computation, but may incur a reduction in accuracy. By default, the second-stage optimization is enabled.

`b = cfirpm(..., 'debug')` enables the display of intermediate results during the filter design, where `'debug'` may be one of `'trace'`, `'plots'`, `'both'`, or `'off'`. By default it is set to `'off'`.

`b = cfirpm(..., {lgrid})` uses the integer `lgrid` to control the density of the frequency grid, which has roughly $2^{\text{nextpow2}(\text{lgrid} \cdot n)}$ frequency points. The default value for `lgrid` is 25. Note that the `{lgrid}` argument must be a 1-by-1 cell array.

Any combination of the `'sym'`, `'skip_stage2'`, `'debug'`, and `{lgrid}` options may be specified.

`[b,delta] = cfirpm(...)` returns the maximum ripple height `delta`.

`[b,delta,opt] = cfirpm(...)` returns a structure `opt` of optional results computed by `cfirpm` and contains the following fields.

Field	Description
<code>opt.fgrid</code>	Frequency grid vector used for the filter design optimization
<code>opt.des</code>	Desired frequency response for each point in <code>opt.fgrid</code>
<code>opt.wt</code>	Weighting for each point in <code>opt.fgrid</code>
<code>opt.H</code>	Actual frequency response for each point in <code>opt.fgrid</code>
<code>opt.error</code>	Error at each point in <code>opt.fgrid</code>
<code>opt.iextr</code>	Vector of indices into <code>opt.fgrid</code> for extremal frequencies
<code>opt.fextr</code>	Vector of extremal frequencies

User-definable functions may be used, instead of the predefined frequency response functions for `@fresp`. The function is called from within `cfirpm` using the following syntax

```
[dh,dw] = fresp(n,f,gf,w,p1,p2,...)
```

where:

- `n` is the filter order.
- `f` is the vector of frequency band edges that appear monotonically between -1 and 1, where 1 corresponds to the Nyquist frequency.
- `gf` is a vector of grid points that have been linearly interpolated over each specified frequency band by `cfirpm`. `gf` determines the frequency grid at which the response

function must be evaluated. This is the same data returned by `cfirpm` in the `fgrid` field of the `opt` structure.

- `w` is a vector of real, positive weights, one per band, used during optimization. `w` is optional in the call to `cfirpm`; if not specified, it is set to unity weighting before being passed to `fresp`.
- `dh` and `dw` are the desired complex frequency response and band weight vectors, respectively, evaluated at each frequency in grid `gf`.
- `p1`, `p2`, `...`, are optional parameters that may be passed to `fresp`.

Additionally, a preliminary call is made to `fresp` to determine the default symmetry property '`sym`'. This call is made using the syntax:

```
sym = fresp('defaults',{n,f,[],w,p1,p2,...})
```

The arguments may be used in determining an appropriate symmetry default as necessary. The function `private/lowpass.m` may be useful as a template for generating new frequency response functions.

Examples

Equiripple Lowpass Filter

Design a 31-tap linear-phase lowpass filter. Display its magnitude and phase responses.

```
b = cfirpm(30,[-1 -0.5 -0.4 0.7 0.8 1],@lowpass);
fvtool(b,1,'OverlaidAnalysis','phase')
```

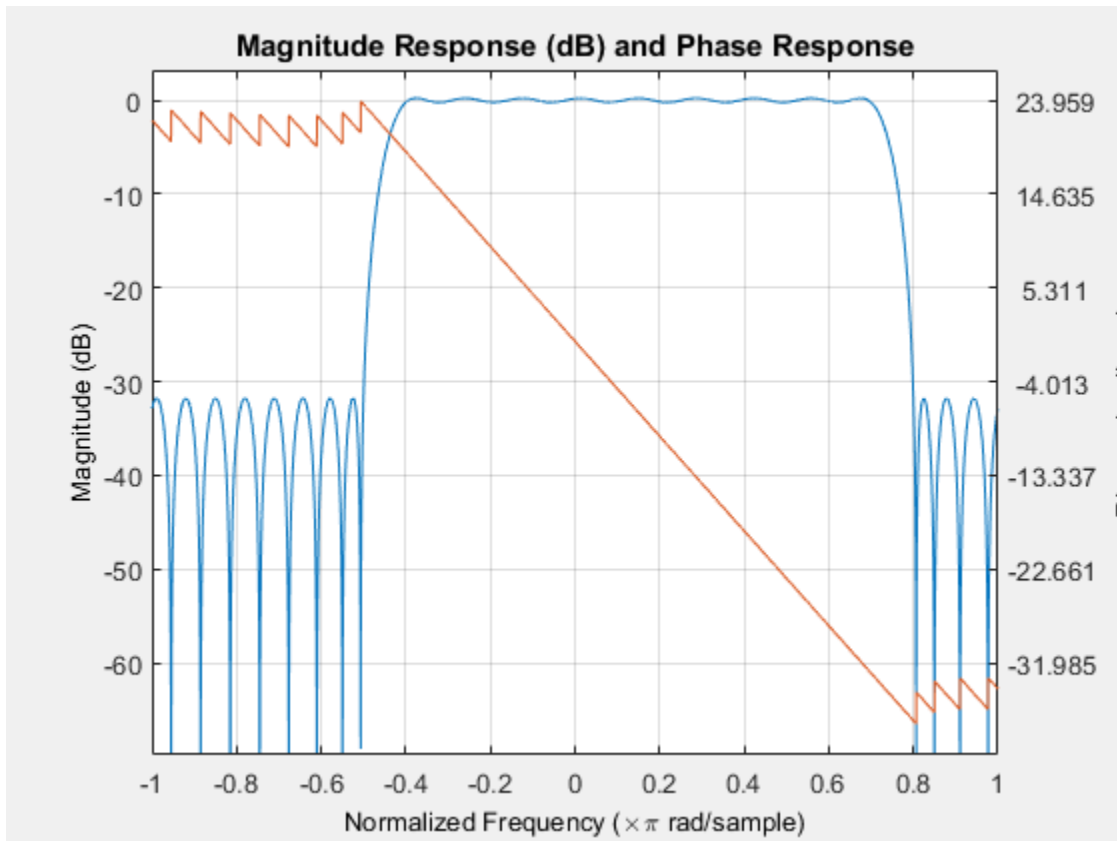

FIR Approximation to Allpass Response

Design a nonlinear-phase allpass FIR filter of order 22 with frequency response given approximately by $\exp(-j\pi fN/2 + j4\pi f|f|)$, where $f \in [-1, 1]$.

```
n = 22; % Filter order
f = [-1 1]; % Frequency band edges
w = [1 1]; % Weights for optimization
gf = linspace(-1,1,256); % Grid of frequency points
d = exp(-1i*pi*gf*n/2 + 1i*pi*pi*sign(gf).*gf.*gf*(4/pi)); % Desired frequency response
```

Use `cfirpm` to compute the FIR filter. Plot the actual and approximate magnitude responses in dB and the phase responses in degrees.

```
b = cfirpm(n,f,'allpass',w,'real'); % Approximation
freqz(b,1,256,'whole')

subplot(2,1,1) % Overlay response
hold on
plot(pi*(gf+1),20*log10(abs(fftshift(d))),'r--')

subplot(2,1,2)
hold on
plot(pi*(gf+1),unwrap(angle(fftshift(d)))*180/pi,'r--')
legend('Approximation','Desired','Location','SouthWest')
```

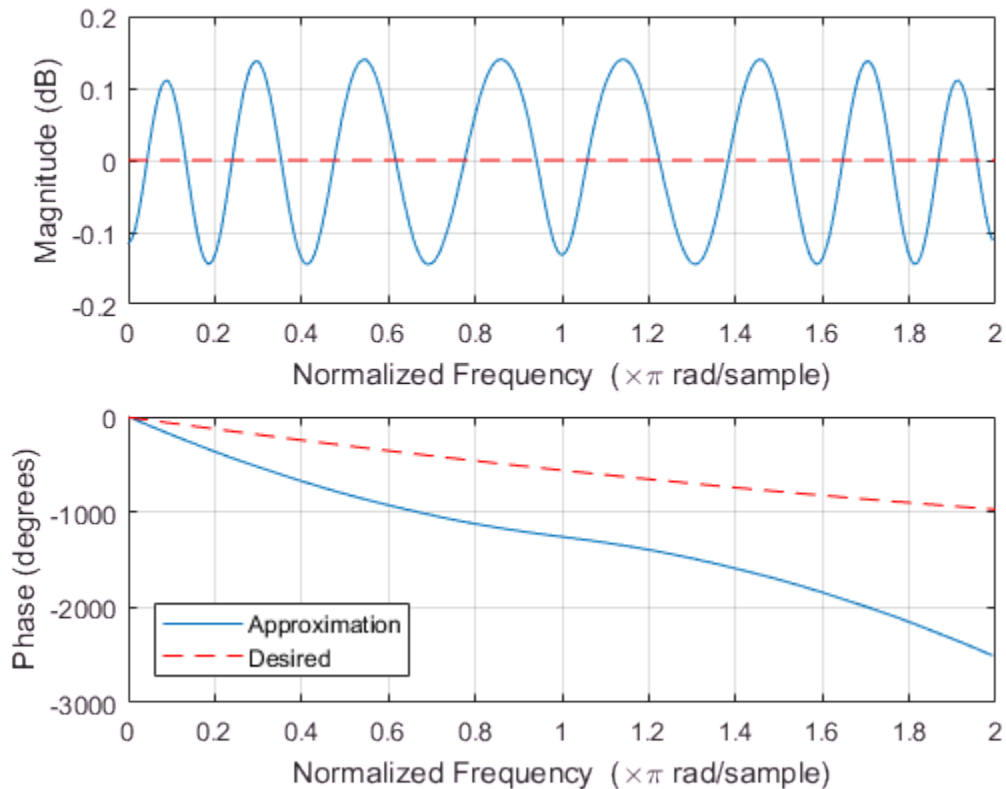

Algorithms

An extended version of the Remez exchange method is implemented for the complex case. This exchange method obtains the optimal filter when the equiripple nature of the filter is restricted to have $n+2$ extremals. When it does not converge, the algorithm switches to an ascent-descent algorithm that takes over to finish the convergence to the optimal solution. See the references for further details.

References

- [1] Karam, L.J., and J.H. McClellan. “Complex Chebyshev Approximation for FIR Filter Design.” *IEEE Trans. on Circuits and Systems II*, March 1995. Pgs.207-216.
- [2] Karam, L.J. *Design of Complex Digital FIR Filters in the Chebyshev Sense*, Ph.D. Thesis, Georgia Institute of Technology, March 1995.
- [3] Demjanjov, V.F., and V.N. Malozemov. *Introduction to Minimax*, New York: John Wiley & Sons, 1974.

Extended Capabilities

C/C++ Code Generation

Generate C and C++ code using MATLAB® Coder™.

Usage notes and limitations:

All inputs must be constants. Expressions or variables are allowed if their values do not change.

See Also

`fir1` | `fir2` | `firls` | `firpm`

Introduced before R2006a

cheb1ap

Chebyshev Type I analog lowpass filter prototype

Syntax

```
[z,p,k] = cheb1ap(n,Rp)
```

Description

`[z,p,k] = cheb1ap(n,Rp)` returns the poles and gain of an order n Chebyshev Type I analog lowpass filter prototype with R_p dB of ripple in the passband. The function returns the poles in the length n column vector \mathbf{p} and the gain in scalar k . \mathbf{z} is an empty matrix, because there are no zeros. The transfer function is

$$H(s) = \frac{z(s)}{p(s)} = \frac{k}{(s-p(1))(s-p(2))\dots(s-p(n))}$$

Chebyshev Type I filters are equiripple in the passband and monotonic in the stopband. The poles are evenly spaced about an ellipse in the left half plane. The Chebyshev Type I passband edge angular frequency ω_0 is set to 1.0 for a normalized result. This is the frequency at which the passband ends and the filter has magnitude response of $10^{-R_p/20}$.

Examples

Frequency Response of an Analog Chebyshev Type I Filter

Design a 6th-order Chebyshev Type I analog lowpass filter with 3 dB of ripple in the passband. Display its magnitude and phase responses.

```
[z,p,k] = cheb1ap(6,3);           % Lowpass filter prototype
[num,den] = zp2tf(z,p,k);        % Convert to transfer function form
freqs(num,den)                   % Frequency response of analog filter
```

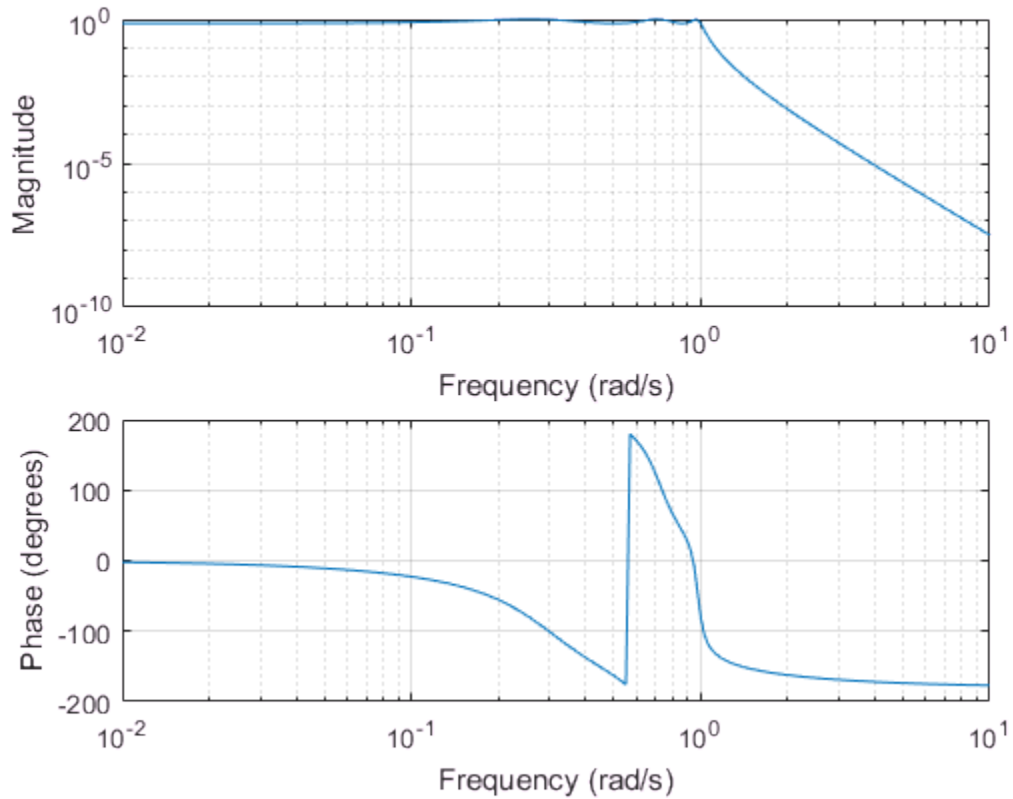
References

- [1] Parks, Thomas W., and C. Sidney Burrus. *Digital Filter Design*. New York: John Wiley & Sons, 1987, chap.7.

Extended Capabilities

C/C++ Code Generation

Generate C and C++ code using MATLAB® Coder™.

Usage notes and limitations:

All inputs must be constants. Expressions or variables are allowed if their values do not change.

See Also

[buttap](#) | [cheby1](#) | [besselap](#) | [cheb2ap](#) | [ellipap](#)

Introduced before R2006a

cheb1ord

Chebyshev Type I filter order

Syntax

```
[n,Wp] = cheb1ord(Wp,Ws,Rp,Rs)
[n,Wp] = cheb1ord(Wp,Ws,Rp,Rs, 's')
```

Description

`cheb1ord` calculates the minimum order of a digital or analog Chebyshev Type I filter required to meet a set of filter design specifications.

Digital Domain

`[n,Wp] = cheb1ord(Wp,Ws,Rp,Rs)` returns the lowest order `n` of the Chebyshev Type I filter that loses no more than `Rp` dB in the passband and has at least `Rs` dB of attenuation in the stopband. The scalar (or vector) of corresponding cutoff frequencies `Wp`, is also returned. Use the output arguments `n` and `Wp` with the `cheby1` function.

Choose the input arguments to specify the stopband and passband according to the following table.

Description of Stopband and Passband Filter Parameters

Parameter	Description
<code>Wp</code>	Passband corner frequency <code>Wp</code> , the cutoff frequency, is a scalar or a two-element vector with values between 0 and 1, with 1 corresponding to the normalized Nyquist frequency, π radians per sample.
<code>Ws</code>	Stopband corner frequency <code>Ws</code> , is a scalar or a two-element vector with values between 0 and 1, with 1 corresponding to the normalized Nyquist frequency.
<code>Rp</code>	Passband ripple, in decibels. This value is the maximum permissible passband loss in decibels.

Parameter	Description
Rs	Stopband attenuation, in decibels. This value is the number of decibels the stopband is down from the passband.

Use the following guide to specify filters of different types.

Filter Type Stopband and Passband Specifications

Filter Type	Stopband and Passband Conditions	Stopband	Passband
Lowpass	$W_p < W_s$, both scalars	$(W_s, 1)$	$(0, W_p)$
Highpass	$W_p > W_s$, both scalars	$(0, W_s)$	$(W_p, 1)$
Bandpass	The interval specified by W_s contains the one specified by W_p ($W_s(1) < W_p(1) < W_p(2) < W_s(2)$).	$(0, W_s(1))$ and $(W_s(2), 1)$	$(W_p(1), W_p(2))$
Bandstop	The interval specified by W_p contains the one specified by W_s ($W_p(1) < W_s(1) < W_s(2) < W_p(2)$).	$(0, W_p(1))$ and $(W_p(2), 1)$	$(W_s(1), W_s(2))$

If your filter specifications call for a bandpass or bandstop filter with unequal ripple in each of the passbands or stopbands, design separate lowpass and highpass filters according to the specifications in this table, and cascade the two filters together.

Analog Domain

`[n, Wp] = cheb1ord(Wp, Ws, Rp, Rs, 's')` finds the minimum order n and cutoff frequencies W_p for an analog Chebyshev Type I filter. You specify the frequencies W_p and W_s similar to those described in the Description of Stopband and Passband Filter Parameters table above, only in this case you specify the frequency in radians per second, and the passband or the stopband can be infinite.

Use `cheb1ord` for lowpass, highpass, bandpass, and bandstop filters as described in the Filter Type Stopband and Passband Specifications table above.

Examples

Chebyshev Type I Filter Design

For data sampled at 1000 Hz, design a lowpass filter with less than 3 dB of ripple in the passband defined from 0 to 40 Hz and at least 60 dB of ripple in the stopband defined from 150 Hz to the Nyquist frequency.

```
Wp = 40/500;  
Ws = 150/500;  
Rp = 3;  
Rs = 60;  
[n,Wp] = cheb1ord(Wp,Ws,Rp,Rs)  
  
n = 4  
  
Wp = 0.0800  
  
[b,a] = cheby1(n,Rp,Wp);  
freqz(b,a,512,1000)  
title('n = 4 Chebyshev Type I Lowpass Filter')
```

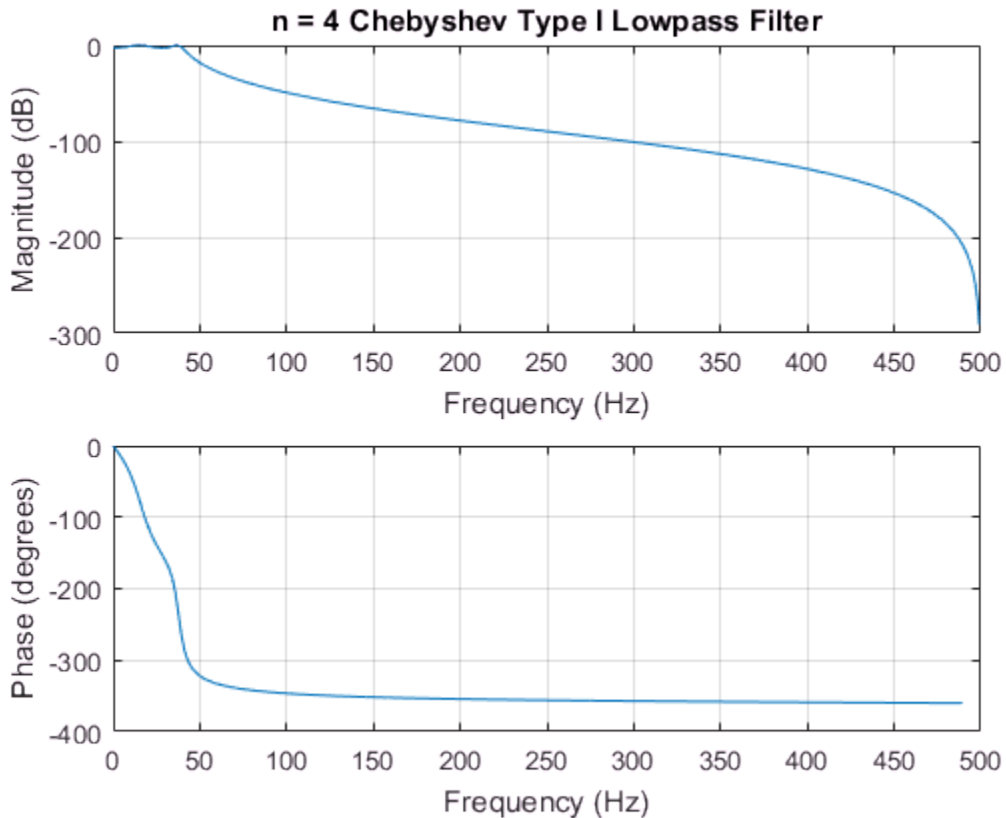

Design a bandpass filter with a passband of 60 Hz to 200 Hz, with less than 3 dB of ripple in the passband, and 40 dB attenuation in the stopbands that are 50 Hz wide on both sides of the passband.

```

Wp = [ 60 200 ] / 500;
Ws = [ 50 250 ] / 500;
Rp = 3;
Rs = 40;
[ n, Wp ] = cheb1ord(Wp, Ws, Rp, Rs)

```

n = 7

Wp =

```
0.1200  0.4000
```

```
[b,a] = cheby1(n,Rp,Wp);  
freqz(b,a,512,1000)  
title('n = 7 Chebyshev Type I Bandpass Filter')
```

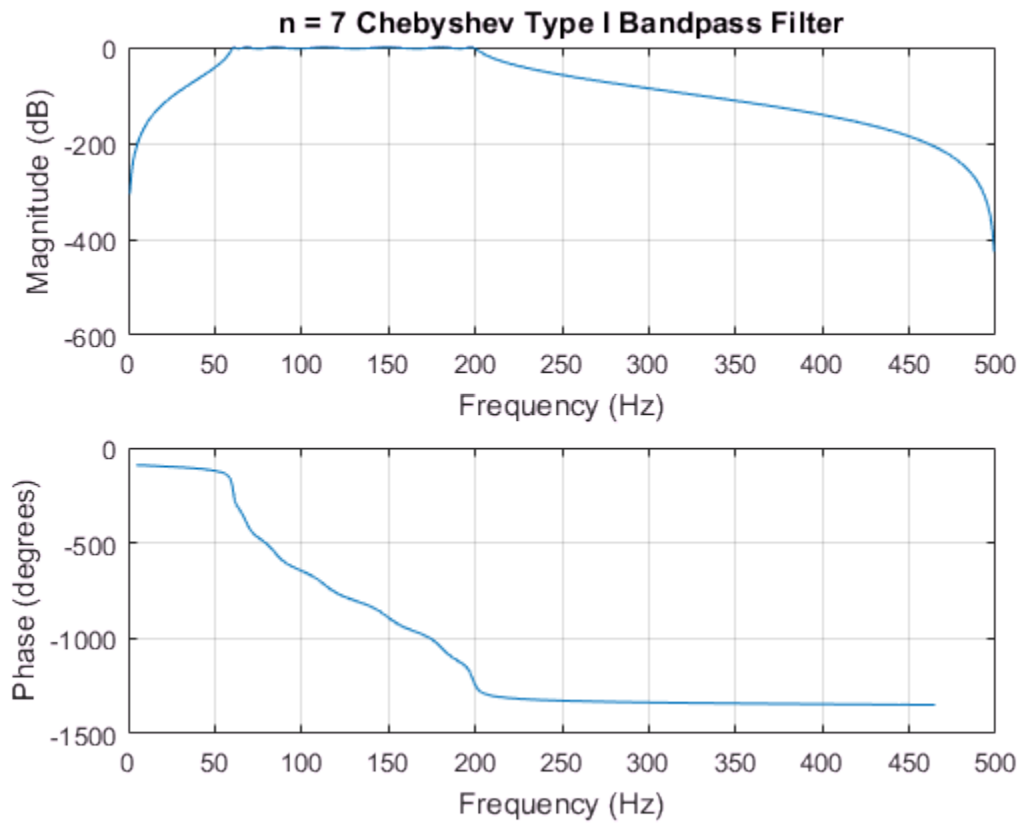

Algorithms

cheb1ord uses the Chebyshev lowpass filter order prediction formula described in [1]. The function performs its calculations in the analog domain for both analog and digital

cases. For the digital case, it converts the frequency parameters to the s -domain before the order and natural frequency estimation process, and then converts them back to the z -domain.

`cheb1ord` initially develops a lowpass filter prototype by transforming the passband frequencies of the desired filter to 1 rad/s (for low- or highpass filters) or to -1 and 1 rad/s (for bandpass or bandstop filters). It then computes the minimum order required for a lowpass filter to meet the stopband specification.

References

- [1] Rabiner, Lawrence R., and Bernard Gold. *Theory and Application of Digital Signal Processing*. Englewood Cliffs, NJ: Prentice-Hall, 1975.

Extended Capabilities

C/C++ Code Generation

Generate C and C++ code using MATLAB® Coder™.

Usage notes and limitations:

All inputs must be constants. Expressions or variables are allowed if their values do not change.

See Also

`buttord` | `cheby1` | `cheb2ord` | `ellipord` | `kaiserord`

Introduced before R2006a

cheb2ap

Chebyshev Type II analog lowpass filter prototype

Syntax

`[z,p,k] = cheb2ap(n,Rs)`

Description

`[z,p,k] = cheb2ap(n,Rs)` finds the zeros, poles, and gain of an order n Chebyshev Type II analog lowpass filter prototype with stopband ripple RS dB down from the passband peak value. `cheb2ap` returns the zeros and poles in length n column vectors z and p and the gain in scalar k . If n is odd, z is length $n-1$. The transfer function is

$$H(s) = \frac{z(s)}{p(s)} = k \frac{(s - z(1))(s - z(2)) \cdots (s - z(n))}{(s - p(1))(s - p(2)) \cdots (s - p(n))}$$

Chebyshev Type II filters are monotonic in the passband and equiripple in the stopband. The pole locations are the inverse of the pole locations of `cheb1ap`, whose poles are evenly spaced about an ellipse in the left half plane. The Chebyshev Type II stopband edge angular frequency ω_0 is set to 1 for a normalized result. This is the frequency at which the stopband begins and the filter has magnitude response of $10^{-Rs/20}$.

Examples

Frequency Response of an Analog Chebyshev Type II Filter

Design a 6th-order Chebyshev Type II analog lowpass filter with 70 dB of ripple in the stopband. Display its magnitude and phase responses.

```
[z,p,k] = cheb2ap(6,70);      % Lowpass filter prototype
[num,den] = zp2tf(z,p,k);    % Convert to transfer function form
freqs(num,den)               % Frequency response of analog filter
```

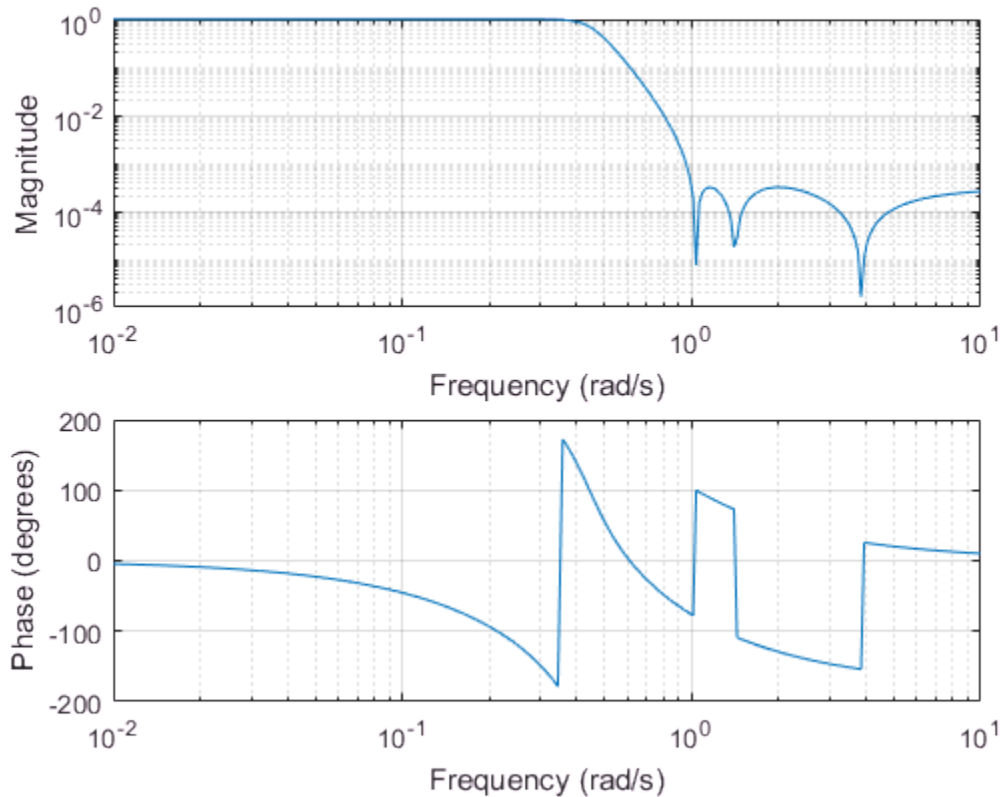

Algorithms

Chebyshev Type II filters are sometimes called *inverse Chebyshev* filters because of their relationship to Chebyshev Type I filters. The `cheb2ap` function is a modification of the Chebyshev Type I prototype algorithm:

- 1 `cheb2ap` replaces the frequency variable ω with $1/\omega$, turning the lowpass filter into a highpass filter while preserving the performance at $\omega = 1$.
- 2 `cheb2ap` subtracts the filter transfer function from unity.

References

- [1] Parks, Thomas W., and C. Sidney Burrus. *Digital Filter Design*. New York: John Wiley & Sons, 1987, chap.7.

Extended Capabilities

C/C++ Code Generation

Generate C and C++ code using MATLAB® Coder™.

Usage notes and limitations:

All inputs must be constants. Expressions or variables are allowed if their values do not change.

See Also

[besselap](#) | [cheby2](#) | [buttap](#) | [cheb1ap](#) | [ellipap](#)

Introduced before R2006a

cheb2ord

Chebyshev Type II filter order

Syntax

```
[n,Ws] = cheb2ord(Wp,Ws,Rp,Rs)
[n,Ws] = cheb2ord(Wp,Ws,Rp,Rs, 's')
```

Description

`cheb2ord` calculates the minimum order of a digital or analog Chebyshev Type II filter required to meet a set of filter design specifications.

Digital Domain

`[n,Ws] = cheb2ord(Wp,Ws,Rp,Rs)` returns the lowest order `n` of the Chebyshev Type II filter that loses no more than `Rp` dB in the passband and has at least `Rs` dB of attenuation in the stopband. The scalar (or vector) of corresponding cutoff frequencies `Ws`, is also returned. Use the output arguments `n` and `Ws` in `cheby2`.

Choose the input arguments to specify the stopband and passband according to the following table.

Description of Stopband and Passband Filter Parameters

Parameter	Description
<code>Wp</code>	Passband corner frequency <code>Wp</code> , the cutoff frequency, is a scalar or a two-element vector with values between 0 and 1, with 1 corresponding to the normalized Nyquist frequency, π radians per sample.
<code>Ws</code>	Stopband corner frequency <code>Ws</code> , is a scalar or a two-element vector with values between 0 and 1, with 1 corresponding to the normalized Nyquist frequency.
<code>Rp</code>	Passband ripple, in decibels. This value is the maximum permissible passband loss in decibels.

Parameter	Description
Rs	Stopband attenuation, in decibels. This value is the number of decibels the stopband is down from the passband.

Use the following guide to specify filters of different types.

Filter Type Stopband and Passband Specifications

Filter Type	Stopband and Passband Conditions	Stopband	Passband
Lowpass	$W_p < W_s$, both scalars	$(W_s, 1)$	$(0, W_p)$
Highpass	$W_p > W_s$, both scalars	$(0, W_s)$	$(W_p, 1)$
Bandpass	The interval specified by W_s contains the one specified by W_p ($W_s(1) < W_p(1) < W_p(2) < W_s(2)$).	$(0, W_s(1))$ and $(W_s(2), 1)$	$(W_p(1), W_p(2))$
Bandstop	The interval specified by W_p contains the one specified by W_s ($W_p(1) < W_s(1) < W_s(2) < W_p(2)$).	$(0, W_p(1))$ and $(W_p(2), 1)$	$(W_s(1), W_s(2))$

If your filter specifications call for a bandpass or bandstop filter with unequal ripple in each of the passbands or stopbands, design separate lowpass and highpass filters according to the specifications in this table, and cascade the two filters together.

Analog Domain

$[n, W_s] = \text{cheb2ord}(W_p, W_s, R_p, R_s, 's')$ finds the minimum order n and cutoff frequencies W_s for an analog Chebyshev Type II filter. You specify the frequencies W_p and W_s similar to those described in the Description of Stopband and Passband Filter Parameters table above, only in this case you specify the frequency in radians per second, and the passband or the stopband can be infinite.

Use `cheb2ord` for lowpass, highpass, bandpass, and bandstop filters as described in the Filter Type Stopband and Passband Specifications table above.

Examples

Chebyshev Type II Filter Design

For data sampled at 1000 Hz, design a lowpass filter with less than 3 dB of ripple in the passband defined from 0 to 40 Hz, and at least 60 dB of attenuation in the stopband defined from 150 Hz to the Nyquist frequency.

```
Wp = 40/500;  
Ws = 150/500;  
Rp = 3;  
Rs = 60;
```

```
[n,Ws] = cheb2ord(Wp,Ws,Rp,Rs)
```

```
n = 4
```

```
Ws = 0.3000
```

```
[b,a] = cheby2(n,Rs,Ws);
```

```
freqz(b,a,512,1000)
```

```
title('n = 4 Chebyshev Type II Lowpass Filter')
```

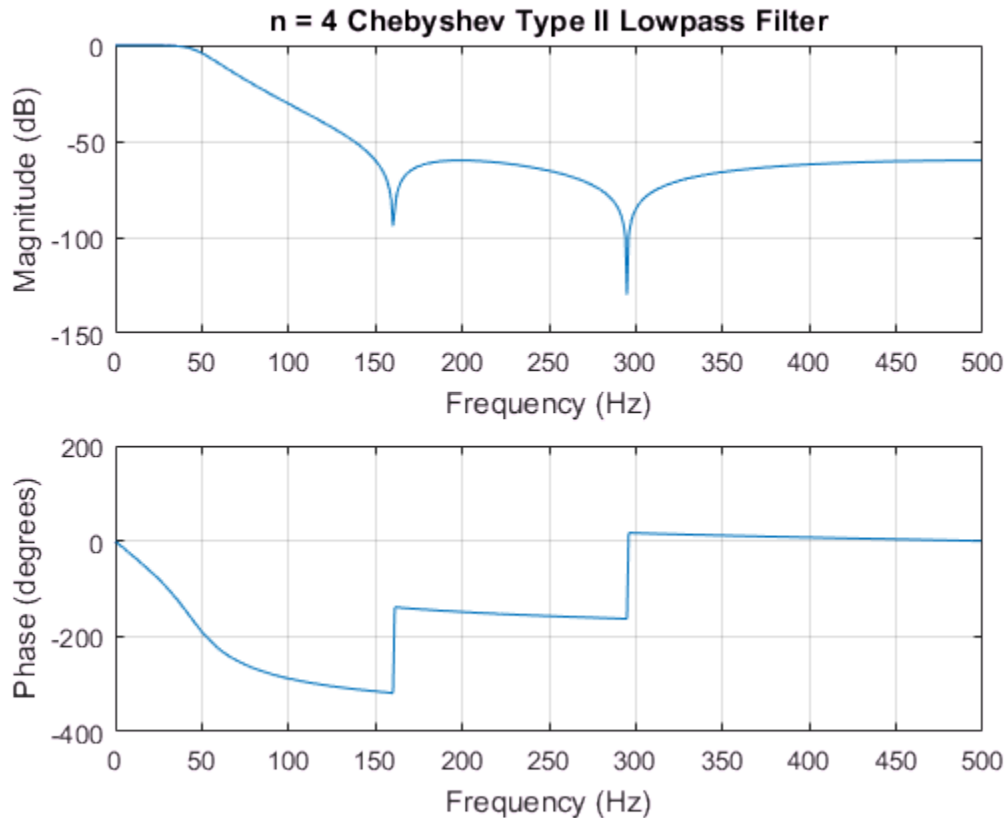

Design a bandpass filter with a passband of 60 Hz to 200 Hz, with less than 3 dB of ripple in the passband, and 40 dB attenuation in the stopbands that are 50 Hz wide on both sides of the passband:

```
Wp = [ 60 200 ] / 500;
Ws = [ 50 250 ] / 500;
Rp = 3;
Rs = 40;
```

```
[ n, Ws ] = cheb2ord(Wp, Ws, Rp, Rs)
```

```
n = 7
```

```
Ws =
```

```

0.1000    0.5000

[b,a] = cheby2(n,Rs,Ws);

freqz(b,a,512,1000)
title('n = 7 Chebyshev Type II Bandpass Filter')

```

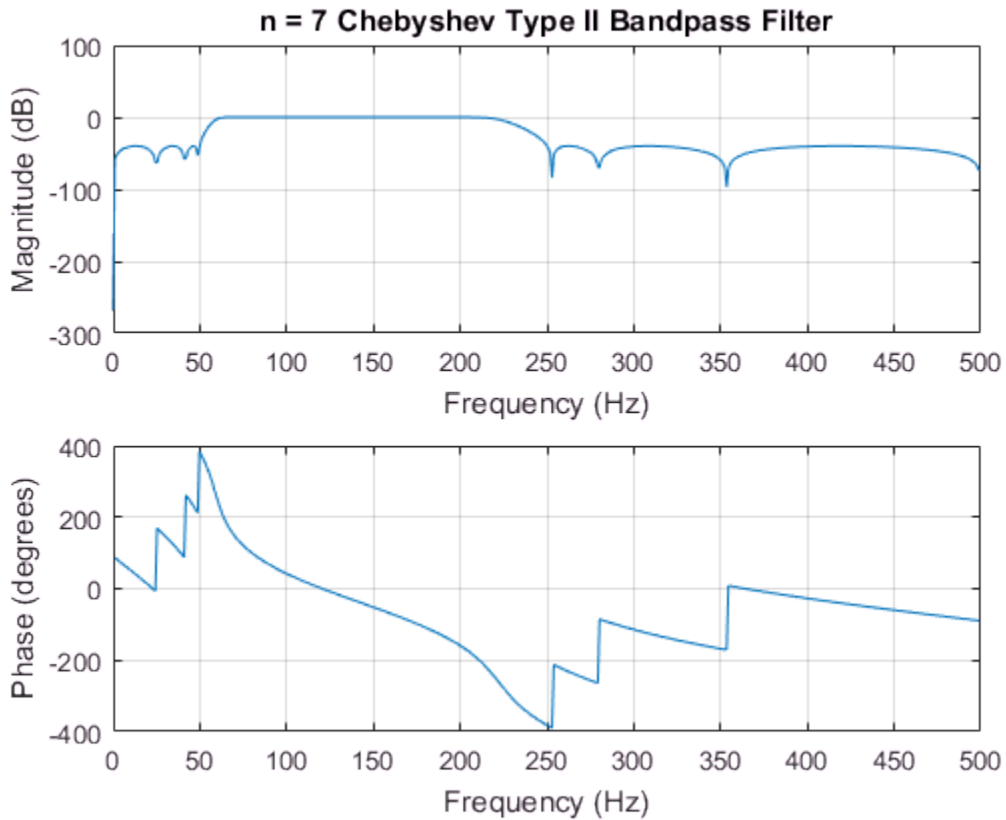

Algorithms

cheb2ord uses the Chebyshev lowpass filter order prediction formula described in [1]. The function performs its calculations in the analog domain for both analog and digital

cases. For the digital case, it converts the frequency parameters to the s -domain before the order and natural frequency estimation process, and then converts them back to the z -domain.

`cheb2ord` initially develops a lowpass filter prototype by transforming the stopband frequencies of the desired filter to 1 rad/s (for low- and highpass filters) and to -1 and 1 rad/s (for bandpass and bandstop filters). It then computes the minimum order required for a lowpass filter to meet the passband specification.

References

- [1] Rabiner, Lawrence R., and Bernard Gold. *Theory and Application of Digital Signal Processing*. Englewood Cliffs, NJ: Prentice-Hall, 1975.

Extended Capabilities

C/C++ Code Generation

Generate C and C++ code using MATLAB® Coder™.

Usage notes and limitations:

All inputs must be constants. Expressions or variables are allowed if their values do not change.

See Also

`buttord` | `cheby2` | `cheb1ord` | `ellipord` | `kaiserord`

Introduced before R2006a

chebwin

Chebyshev window

Syntax

```
w = chebwin(L,r)
```

Description

`w = chebwin(L,r)` returns the column vector `w` containing the length `L` Chebyshev window whose Fourier transform sidelobe magnitude is `r` dB below the mainlobe magnitude. The default value for `r` is 100.0 dB.

Note If you specify a one-point window (set `L=1`), the value 1 is returned.

Examples

Chebyshev Window

Create a 64-point Chebyshev window with 100 dB of sidelobe attenuation. Display the result using `wvtool`.

```
L = 64;  
bw = chebwin(L);  
wvtool(bw)
```

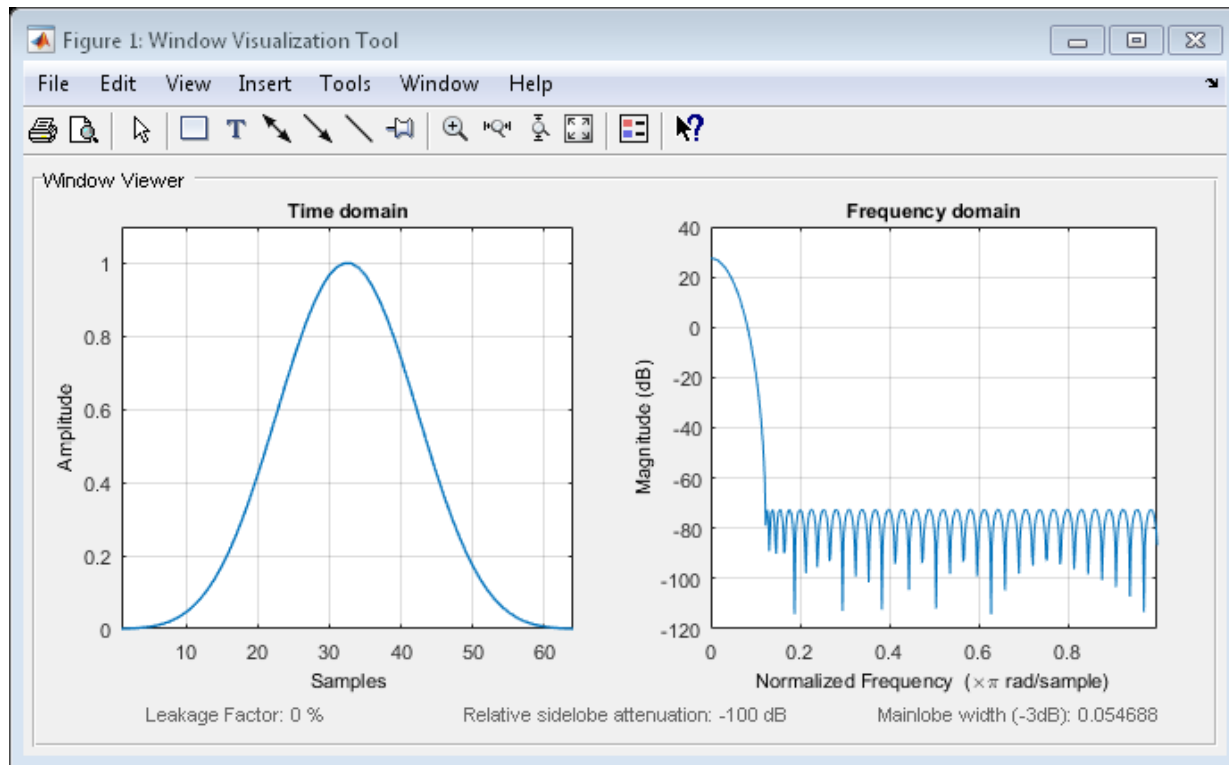

Algorithms

An artifact of the equiripple design method used in `chebwin` is the presence of impulses at the endpoints of the time-domain response. This is due to the constant-level sidelobes in the frequency domain. The magnitude of the impulses are on the order of the size of the spectral sidelobes. If the sidelobes are large, the effect at the endpoints may be significant. For more information on this effect, see [2].

The equivalent noise bandwidth of a Chebyshev window does not grow monotonically with increasing sidelobe attenuation when the attenuation is smaller than about 45 dB. For spectral analysis, use larger sidelobe attenuation values, or, if you need to work with small attenuations, use a Kaiser window.

References

- [1] Digital Signal Processing Committee of the IEEE Acoustics, Speech, and Signal Processing Society, eds. *Programs for Digital Signal Processing*. New York: IEEE Press, 1979, program 5.2.
- [2] Harris, Fredric J. *Multirate Signal Processing for Communication Systems*. Upper Saddle River, NJ: Prentice Hall PTR, 2004, pp. 60–64.

Extended Capabilities

C/C++ Code Generation

Generate C and C++ code using MATLAB® Coder™.

Usage notes and limitations:

All inputs must be constants. Expressions or variables are allowed if their values do not change.

See Also

See Also

Apps

Window Designer

Functions

gausswin | kaiser | tukeywin | window | wvtool

Introduced before R2006a

cheby1

Chebyshev Type I filter design

Syntax

```
[b,a] = cheby1(n,Rp,Wp)
[b,a] = cheby1(n,Rp,Wp,ftype)

[z,p,k] = cheby1(____)
[A,B,C,D] = cheby1(____)

[____] = cheby1(____,'s')
```

Description

`[b,a] = cheby1(n,Rp,Wp)` returns the transfer function coefficients of an n th-order lowpass digital Chebyshev Type I filter with normalized passband edge frequency Wp and Rp decibels of peak-to-peak passband ripple.

`[b,a] = cheby1(n,Rp,Wp,ftype)` designs a lowpass, highpass, bandpass, or bandstop Chebyshev Type I filter, depending on the value of `ftype` and the number of elements of `Wp`. The resulting bandpass and bandstop designs are of order $2n$.

Note: See “Limitations” on page 1-161 for information about numerical issues that affect forming the transfer function.

`[z,p,k] = cheby1(____)` designs a lowpass, highpass, bandpass, or bandstop digital Chebyshev Type I filter and returns its zeros, poles, and gain. This syntax can include any of the input arguments in previous syntaxes.

`[A,B,C,D] = cheby1(____)` designs a lowpass, highpass, bandpass, or bandstop digital Chebyshev Type I filter and returns the matrices that specify its state-space representation.

`[____] = cheby1(____,'s')` designs a lowpass, highpass, bandpass, or bandstop analog Chebyshev Type I filter with passband edge angular frequency Wp and Rp decibels of passband ripple.

Examples

Lowpass Chebyshev Type I Transfer Function

Design a 6th-order lowpass Chebyshev Type I filter with 10 dB of passband ripple and a passband edge frequency of 300 Hz, which, for data sampled at 1000 Hz, corresponds to 0.6π rad/sample. Plot its magnitude and phase responses. Use it to filter a 1000-sample random signal.

```
[b,a] = cheby1(6,10,0.6);  
freqz(b,a)
```

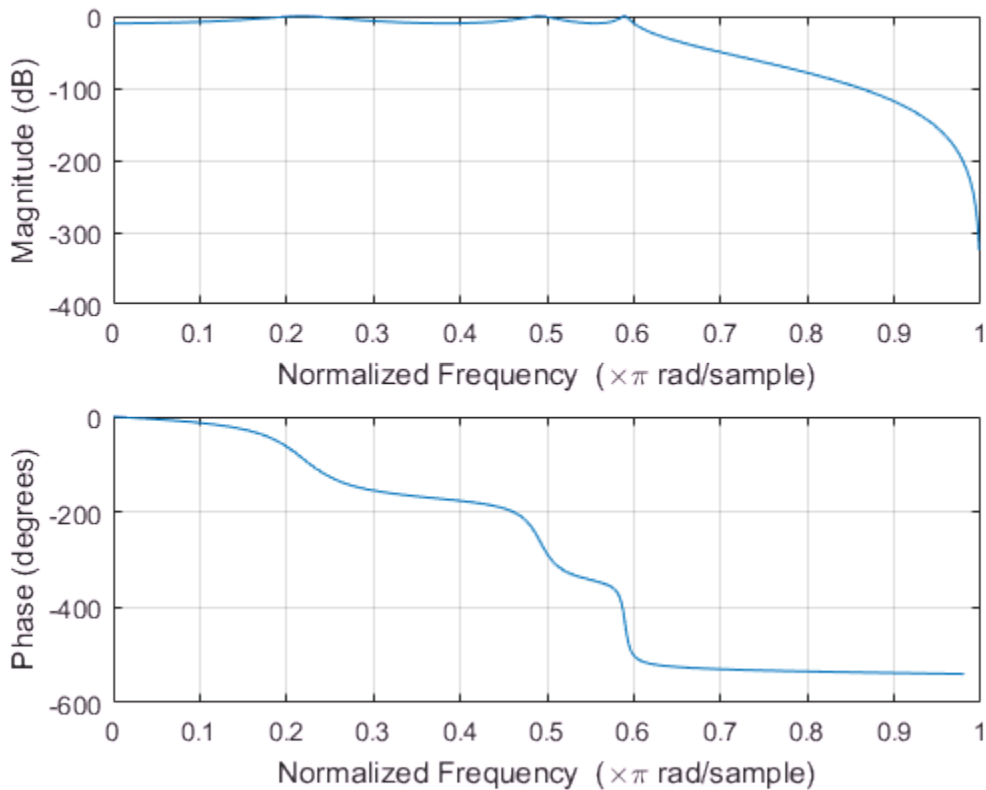

```
dataIn = randn(1000,1);
```

```
dataOut = filter(b,a,dataIn);
```

Bandstop Chebyshev Type I Filter

Design a 6th-order Chebyshev Type I bandstop filter with normalized edge frequencies of 0.2π and 0.6π rad/sample and 5 dB of passband ripple. Plot its magnitude and phase responses. Use it to filter random data.

```
[b,a] = cheby1(3,5,[0.2 0.6], 'stop');  
freqz(b,a)
```

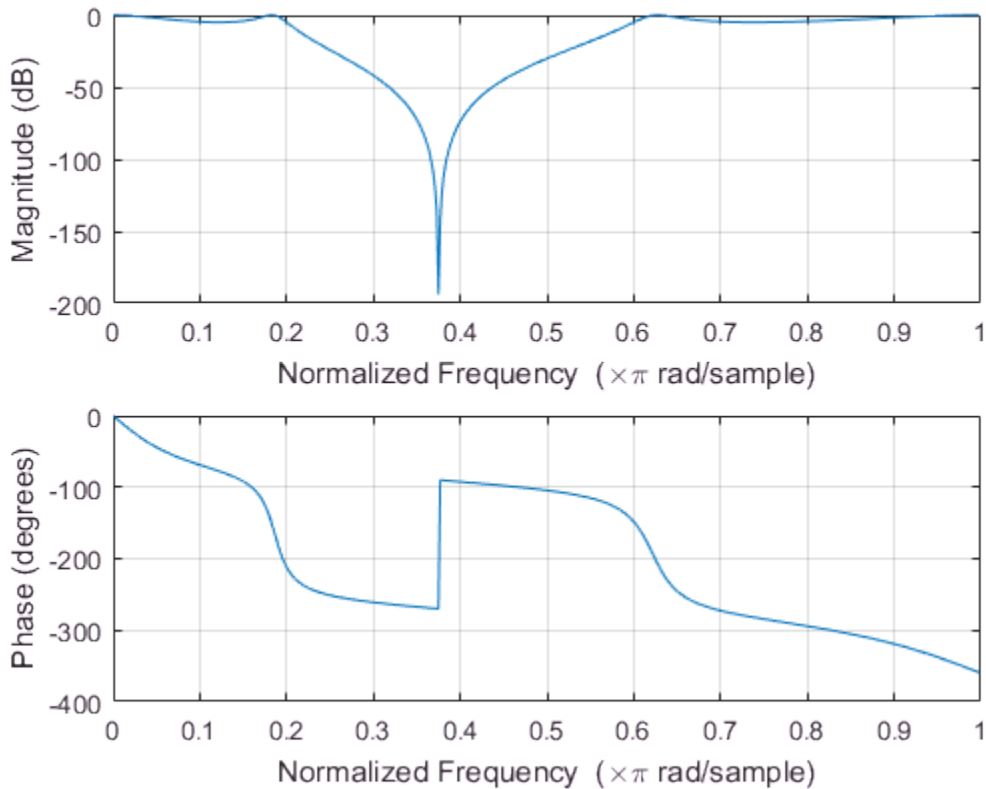

```
dataIn = randn(1000,1);  
dataOut = filter(b,a,dataIn);
```

Highpass Chebyshev Type I Filter

Design a 9th-order highpass Chebyshev Type I filter with 0.5 dB of passband ripple and a passband edge frequency of 300 Hz, which, for data sampled at 1000 Hz, corresponds to 0.6π rad/sample. Plot the magnitude and phase responses. Convert the zeros, poles, and gain to second-order sections for use by `fvtool`.

```
[z,p,k] = cheby1(9,0.5,300/500,'high');  
sos = zp2sos(z,p,k);  
fvtool(sos,'Analysis','freq')
```

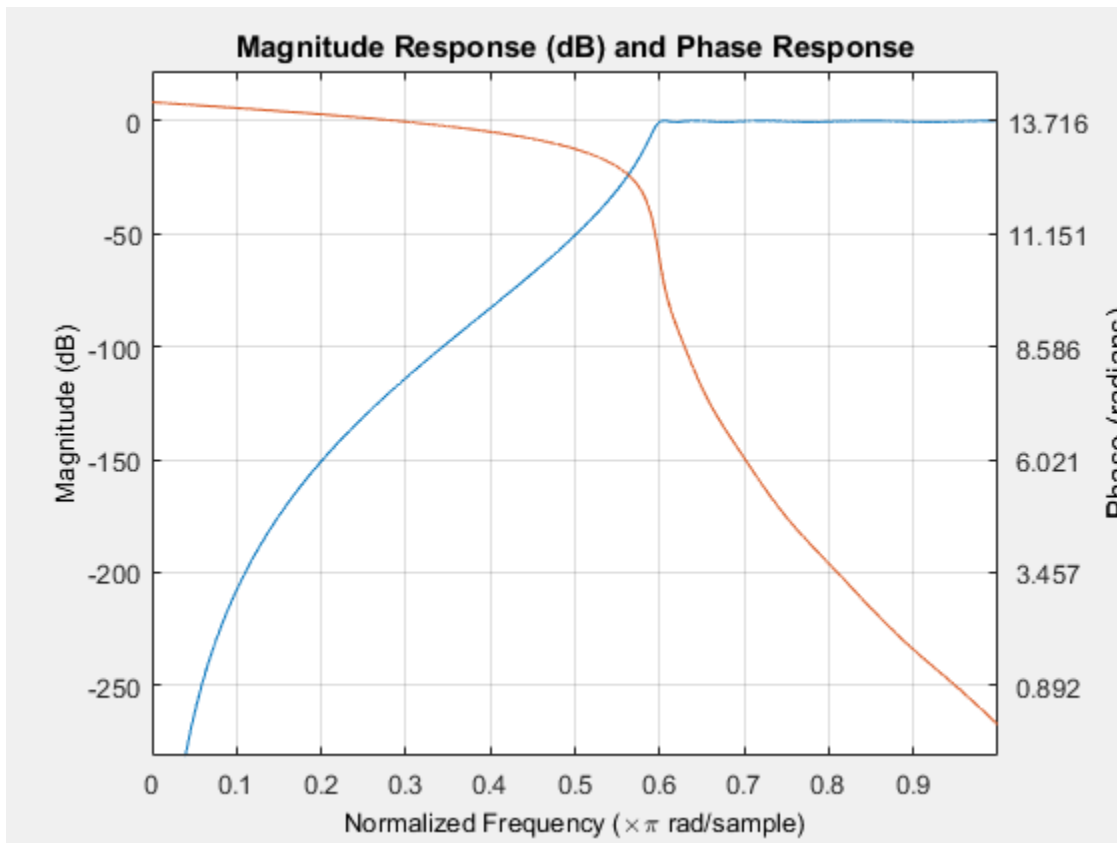

Bandpass Chebyshev Type I Filter

Design a 20th-order Chebyshev Type I bandpass filter with a lower passband frequency of 500 Hz and a higher passband frequency of 560 Hz. Specify a passband ripple of 3 dB and a sample rate of 1500 Hz. Use the state-space representation. Design an identical filter using `designfilt`.

```
[A,B,C,D] = cheby1(10,3,[500 560]/750);  
d = designfilt('bandpassiir','FilterOrder',20, ...  
    'PassbandFrequency1',500,'PassbandFrequency2',560, ...  
    'PassbandRipple',3,'SampleRate',1500);
```

Convert the state-space representation to second-order sections. Visualize the frequency responses using `fvtool`.

```
sos = ss2sos(A,B,C,D);  
fvt = fvtool(sos,d,'Fs',1500);  
legend(fvt,'cheby1','designfilt')
```

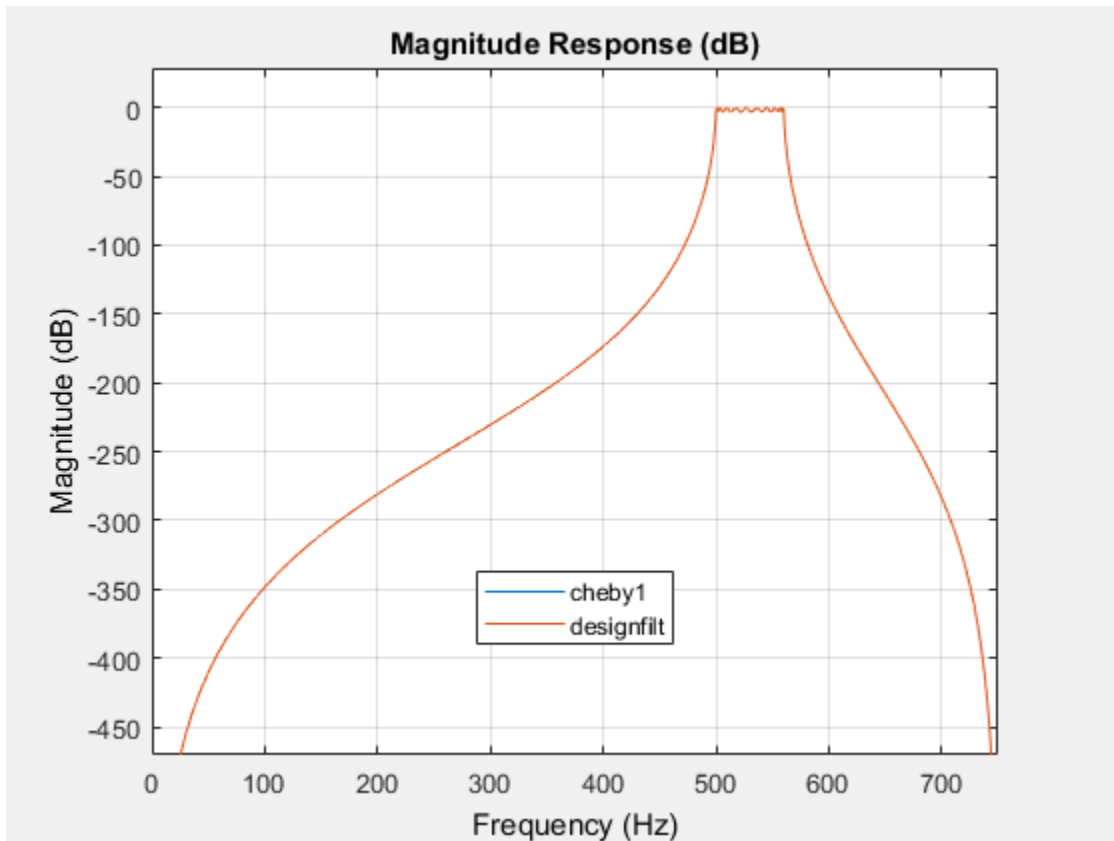

Comparison of Analog IIR Lowpass Filters

Design a 5th-order analog Butterworth lowpass filter with a cutoff frequency of 2 GHz. Multiply by 2π to convert the frequency to radians per second. Compute the frequency response of the filter at 4096 points.

```
n = 5;
f = 2e9;

[zb,pb,kb] = butter(n,2*pi*f,'s');
[bb,ab] = zp2tf(zb,pb,kb);
[hb,wb] = freqs(bb,ab,4096);
```

Design a 5th-order Chebyshev Type I filter with the same edge frequency and 3 dB of passband ripple. Compute its frequency response.

```
[z1,p1,k1] = cheby1(n,3,2*pi*f,'s');
[b1,a1] = zp2tf(z1,p1,k1);
[h1,w1] = freqs(b1,a1,4096);
```

Design a 5th-order Chebyshev Type II filter with the same edge frequency and 30 dB of stopband attenuation. Compute its frequency response.

```
[z2,p2,k2] = cheby2(n,30,2*pi*f,'s');
[b2,a2] = zp2tf(z2,p2,k2);
[h2,w2] = freqs(b2,a2,4096);
```

Design a 5th-order elliptic filter with the same edge frequency, 3 dB of passband ripple, and 30 dB of stopband attenuation. Compute its frequency response.

```
[ze,pe,ke] = ellip(n,3,30,2*pi*f,'s');
[be,ae] = zp2tf(ze,pe,ke);
[he,we] = freqs(be,ae,4096);
```

Plot the attenuation in decibels. Express the frequency in gigahertz. Compare the filters.

```
plot(wb/(2e9*pi),mag2db(abs(hb)))
hold on
plot(w1/(2e9*pi),mag2db(abs(h1)))
plot(w2/(2e9*pi),mag2db(abs(h2)))
plot(we/(2e9*pi),mag2db(abs(he)))
axis([0 4 -40 5])
grid
xlabel('Frequency (GHz)')
ylabel('Attenuation (dB)')
legend('butter','cheby1','cheby2','ellip')
```

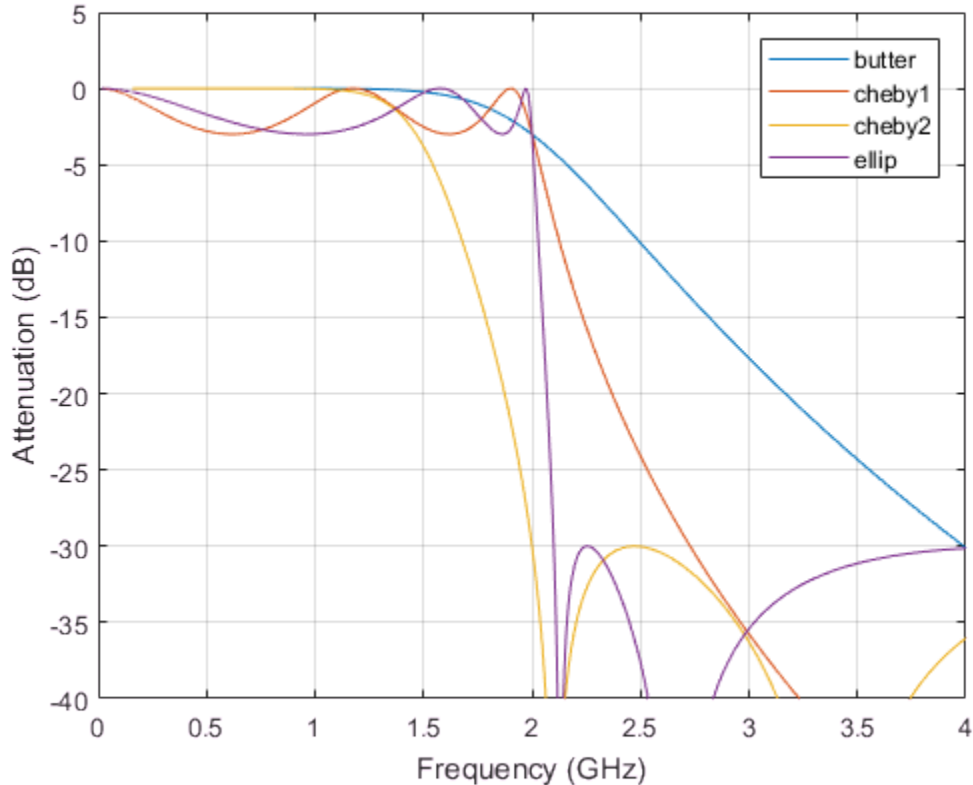

The Butterworth and Chebyshev Type II filters have flat passbands and wide transition bands. The Chebyshev Type I and elliptic filters roll off faster but have passband ripple. The frequency input to the Chebyshev Type II design function sets the beginning of the stopband rather than the end of the passband.

Input Arguments

n — Filter order
integer scalar

Filter order, specified as an integer scalar.

Data Types: double

Rp — Peak-to-peak passband ripple

positive scalar

Peak-to-peak passband ripple, specified as a positive scalar expressed in decibels.

If your specification, ℓ , is in linear units, you can convert it to decibels using

$$R_p = 40 \log_{10}((1+\ell)/(1-\ell)).$$

Data Types: double

Wp — Passband edge frequency

scalar | two-element vector

Passband edge frequency, specified as a scalar or a two-element vector. The passband edge frequency is the frequency at which the magnitude response of the filter is $-R_p$ decibels. Smaller values of passband ripple, R_p , result in wider transition bands.

- If W_p is a scalar, then `cheby1` designs a lowpass or highpass filter with edge frequency W_p .

If W_p is the two-element vector $[w_1 \ w_2]$, where $w_1 < w_2$, then `cheby1` designs a bandpass or bandstop filter with lower edge frequency w_1 and higher edge frequency w_2 .

- For digital filters, the passband edge frequencies must lie between 0 and 1, where 1 corresponds to the Nyquist rate—half the sample rate or π rad/sample.

For analog filters, the passband edge frequencies must be expressed in radians per second and can take on any positive value.

Data Types: double

f type — Filter type

'low' | 'bandpass' | 'high' | 'stop'

Filter type, specified as one of the following:

- 'low' specifies a lowpass filter with passband edge frequency W_p . 'low' is the default for scalar W_p .
- 'high' specifies a highpass filter with passband edge frequency W_p .

- 'bandpass' specifies a bandpass filter of order $2n$ if Wp is a two-element vector. 'bandpass' is the default when Wp has two elements.
- 'stop' specifies a bandstop filter of order $2n$ if Wp is a two-element vector.

Data Types: char

Output Arguments

b, a — Transfer function coefficients

row vectors

Transfer function coefficients of the filter, returned as row vectors of length $n + 1$ for lowpass and highpass filters and $2n + 1$ for bandpass and bandstop filters.

- For digital filters, the transfer function is expressed in terms of **b** and **a** as

$$H(z) = \frac{B(z)}{A(z)} = \frac{b(1) + b(2)z^{-1} + \dots + b(n+1)z^{-n}}{a(1) + a(2)z^{-1} + \dots + a(n+1)z^{-n}}.$$

- For analog filters, the transfer function is expressed in terms of **b** and **a** as

$$H(s) = \frac{B(s)}{A(s)} = \frac{b(1)s^n + b(2)s^{n-1} + \dots + b(n+1)}{a(1)s^n + a(2)s^{n-1} + \dots + a(n+1)}.$$

Data Types: double

z, p, k — Zeros, poles, and gain

column vectors, scalar

Zeros, poles, and gain of the filter, returned as two column vectors of length n ($2n$ for bandpass and bandstop designs) and a scalar.

- For digital filters, the transfer function is expressed in terms of **z**, **p**, and **k** as

$$H(z) = k \frac{(1 - z(1)z^{-1})(1 - z(2)z^{-1}) \dots (1 - z(n)z^{-1})}{(1 - p(1)z^{-1})(1 - p(2)z^{-1}) \dots (1 - p(n)z^{-1})}.$$

- For analog filters, the transfer function is expressed in terms of **z**, **p**, and **k** as

$$H(s) = k \frac{(s - z(1))(s - z(2)) \cdots (s - z(n))}{(s - p(1))(s - p(2)) \cdots (s - p(n))}.$$

Data Types: double

A, B, C, D — State-space matrices matrices

State-space representation of the filter, returned as matrices. If $m = n$ for lowpass and highpass designs and $m = 2n$ for bandpass and bandstop filters, then **A** is $m \times m$, **B** is $m \times 1$, **C** is $1 \times m$, and **D** is 1×1 .

- For digital filters, the state-space matrices relate the state vector x , the input u , and the output y through

$$\begin{aligned}x(k+1) &= A x(k) + B u(k) \\ y(k) &= C x(k) + D u(k).\end{aligned}$$

- For analog filters, the state-space matrices relate the state vector x , the input u , and the output y through

$$\begin{aligned}\dot{x} &= A x + B u \\ y &= C x + D u.\end{aligned}$$

Data Types: double

Definitions

Limitations

Numerical Instability of Transfer Function Syntax

In general, use the `[z, p, k]` syntax to design IIR filters. To analyze or implement your filter, you can then use the `[z, p, k]` output with `zp2sos`. If you design the filter using the `[b, a]` syntax, you might encounter numerical problems. These problems are due to round-off errors and can occur for n as low as 4. The following example illustrates this limitation.

```
n = 6;
```

```

Rp = 0.1;
Wn = [2.5e6 29e6]/500e6;
ftype = 'bandpass';

% Transfer function design
[b,a] = cheby1(n,Rp,Wn,ftype);      % This filter is unstable

% Zero-pole-gain design
[z,p,k] = cheby1(n,Rp,Wn,ftype);
sos = zp2sos(z,p,k);

% Plot and compare the results
hfvt = fvtool(b,a,sos,'FrequencyScale','log');
legend(hfvt,'TF Design','ZPK Design')

```

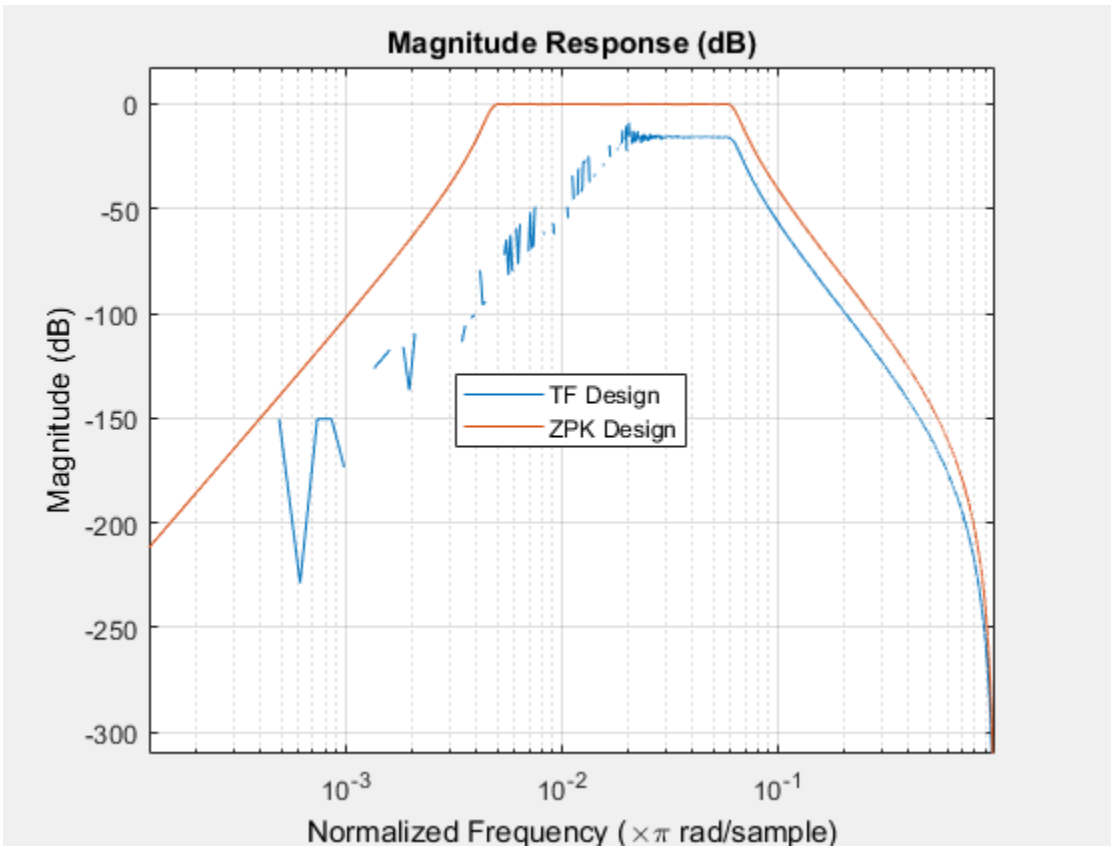

Algorithms

Chebyshev Type I filters are equiripple in the passband and monotonic in the stopband. Type I filters roll off faster than Type II filters, but at the expense of greater deviation from unity in the passband.

`cheby1` uses a five-step algorithm:

- 1 It finds the lowpass analog prototype poles, zeros, and gain using the function `cheb1ap`.
- 2 It converts the poles, zeros, and gain into state-space form.
- 3 If required, it uses a state-space transformation to convert the lowpass filter to a highpass, bandpass, or bandstop filter with the desired frequency constraints.
- 4 For digital filter design, it uses `bilinear` to convert the analog filter into a digital filter through a bilinear transformation with frequency prewarping. Careful frequency adjustment enables the analog filters and the digital filters to have the same frequency response magnitude at ω_p or ω_1 and ω_2 .
- 5 It converts the state-space filter back to transfer function or zero-pole-gain form, as required.

Extended Capabilities

C/C++ Code Generation

Generate C and C++ code using MATLAB® Coder™.

Usage notes and limitations:

All inputs must be constants. Expressions or variables are allowed if their values do not change.

See Also

See Also

`besself` | `butter` | `cheb1ap` | `cheb1ord` | `cheby2` | `designfilt` | `ellip` | `filter`
| `sosfilt`

Introduced before R2006a

cheby2

Chebyshev Type II filter design

Syntax

```
[b,a] = cheby2(n,Rs,Ws)
[b,a] = cheby2(n,Rs,Ws,fstype)

[z,p,k] = cheby2(____)
[A,B,C,D] = cheby2(____)

[____] = cheby2(____,'s')
```

Description

`[b,a] = cheby2(n,Rs,Ws)` returns the transfer function coefficients of an n th-order lowpass digital Chebyshev Type II filter with normalized stopband edge frequency `WS` and `RS` decibels of stopband attenuation down from the peak passband value.

`[b,a] = cheby2(n,Rs,Ws,fstype)` designs a lowpass, highpass, bandpass, or bandstop Chebyshev Type II filter, depending on the value of `fstype` and the number of elements of `WS`. The resulting bandpass and bandstop designs are of order $2n$.

Note: See “Limitations” on page 1-175 for information about numerical issues that affect forming the transfer function.

`[z,p,k] = cheby2(____)` designs a lowpass, highpass, bandpass, or bandstop digital Chebyshev Type II filter and returns its zeros, poles, and gain. This syntax can include any of the input arguments in previous syntaxes.

`[A,B,C,D] = cheby2(____)` designs a lowpass, highpass, bandpass, or bandstop digital Chebyshev Type II filter and returns the matrices that specify its state-space representation.

`[____] = cheby2(____,'s')` designs a lowpass, highpass, bandpass, or bandstop analog Chebyshev Type II filter with stopband edge angular frequency `WS` and `RS` decibels of stopband attenuation.

Examples

Lowpass Chebyshev Type II Transfer Function

Design a 6th-order lowpass Chebyshev Type II filter with 40 dB of stopband attenuation and a stopband edge frequency of 300 Hz, which, for data sampled at 1000 Hz, corresponds to 0.6π rad/sample. Plot its magnitude and phase responses. Use it to filter a 1000-sample random signal.

```
[b,a] = cheby2(6,40,0.6);
freqz(b,a)
```

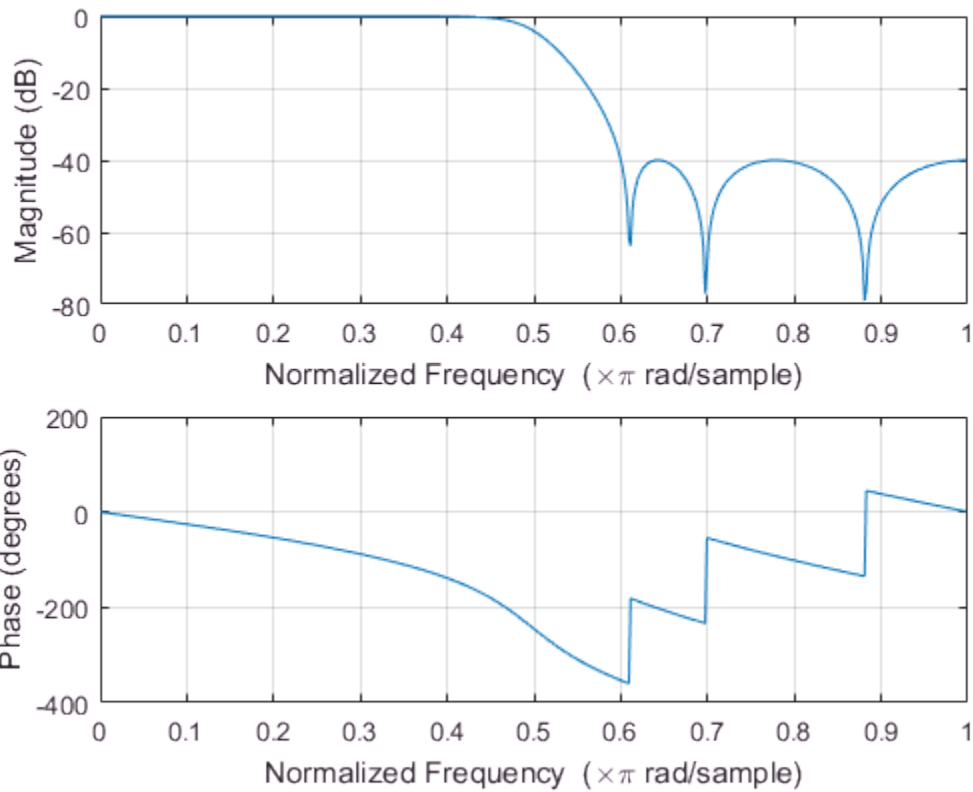

```
dataIn = randn(1000,1);
```

```
dataOut = filter(b,a,dataIn);
```

Bandstop Chebyshev Type II Filter

Design a 6th-order Chebyshev Type II bandstop filter with normalized edge frequencies of 0.2π and 0.6π rad/sample and 50 dB of stopband attenuation. Plot its magnitude and phase responses. Use it to filter random data.

```
[b,a] = cheby2(3,50,[0.2 0.6], 'stop');  
freqz(b,a)
```

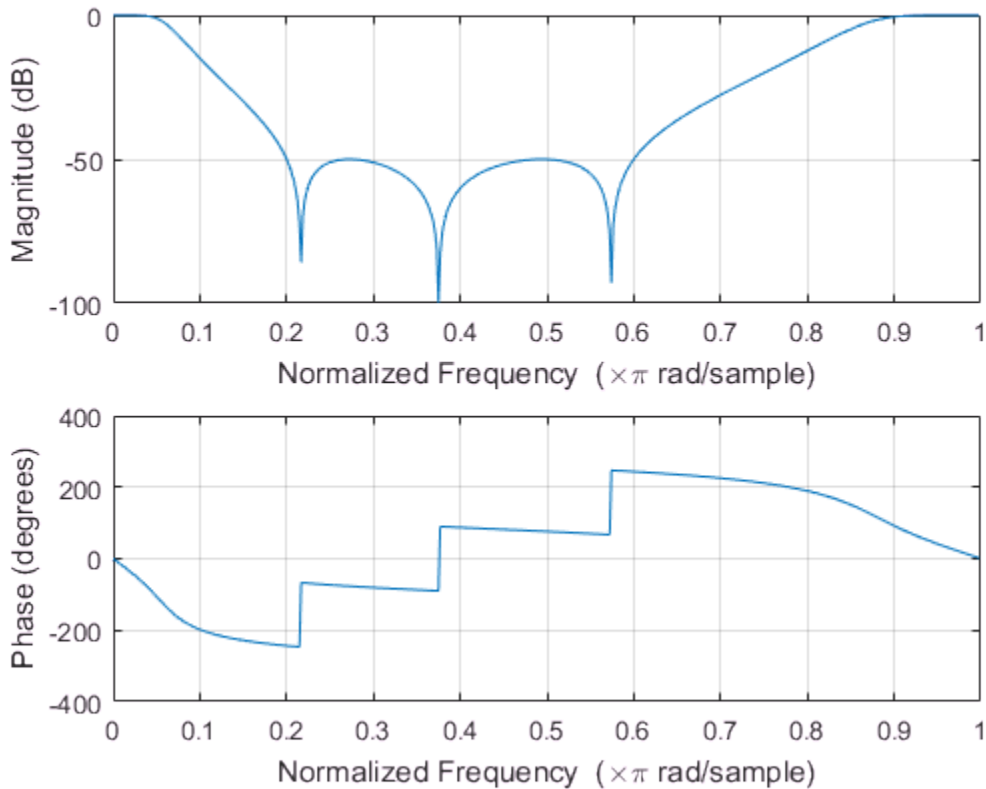

```
dataIn = randn(1000,1);  
dataOut = filter(b,a,dataIn);
```

Highpass Chebyshev Type II Filter

Design a 9th-order highpass Chebyshev Type II filter with 20 dB of stopband attenuation and a stopband edge frequency of 300 Hz, which, for data sampled at 1000 Hz, corresponds to 0.6π rad/sample. Plot the magnitude and phase responses. Convert the zeros, poles, and gain to second-order sections for use by `fvtool`.

```
[z,p,k] = cheby2(9,20,300/500, 'high');  
sos = zp2sos(z,p,k);  
fvtool(sos, 'Analysis', 'freq')
```

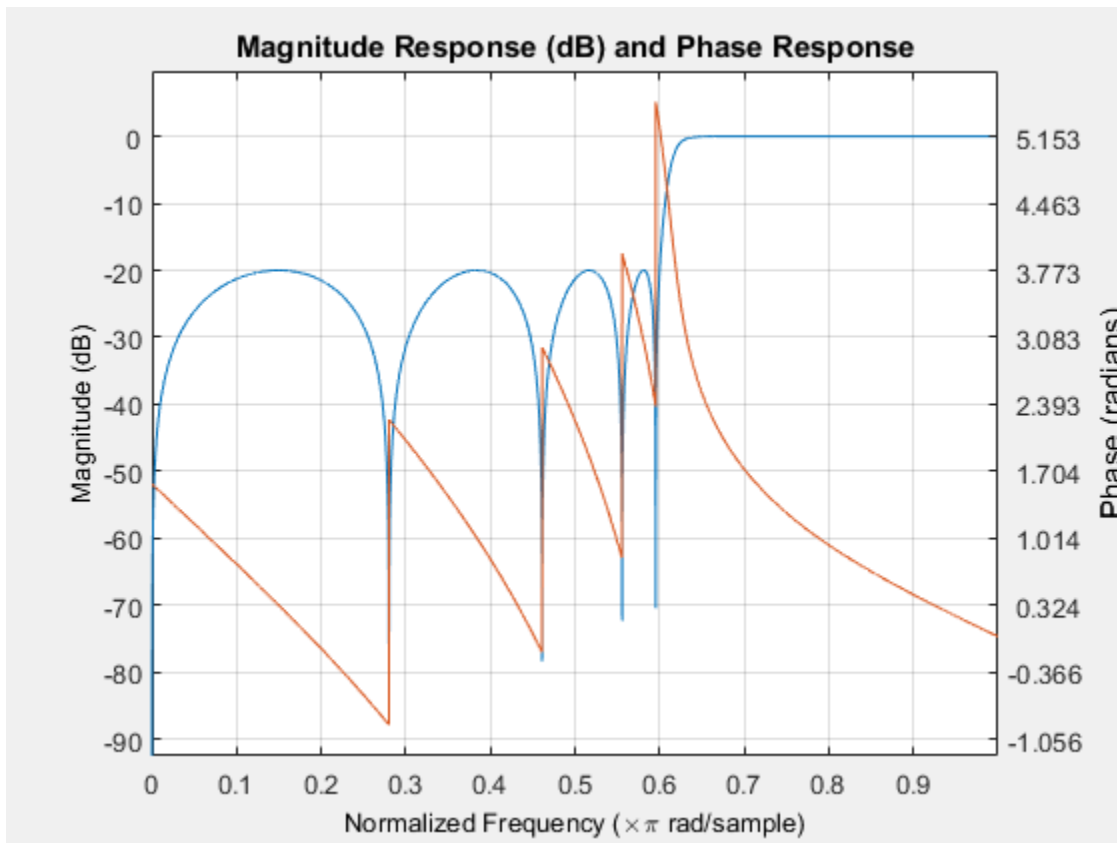

Bandpass Chebyshev Type II Filter

Design a 20th-order Chebyshev Type II bandpass filter with a lower stopband frequency of 500 Hz and a higher stopband frequency of 560 Hz. Specify a stopband attenuation of 40 dB and a sample rate of 1500 Hz. Use the state-space representation. Design an identical filter using `designfilt`.

```
[A,B,C,D] = cheby2(10,40,[500 560]/750);  
d = designfilt('bandpassiir','FilterOrder',20, ...  
    'StopbandFrequency1',500,'StopbandFrequency2',560, ...  
    'StopbandAttenuation',40,'SampleRate',1500);
```

Convert the state-space representation to second-order sections. Visualize the frequency responses using `fvtool`.

```
sos = ss2sos(A,B,C,D);  
fvt = fvtool(sos,d,'Fs',1500);  
legend(fvt,'cheby2','designfilt')
```

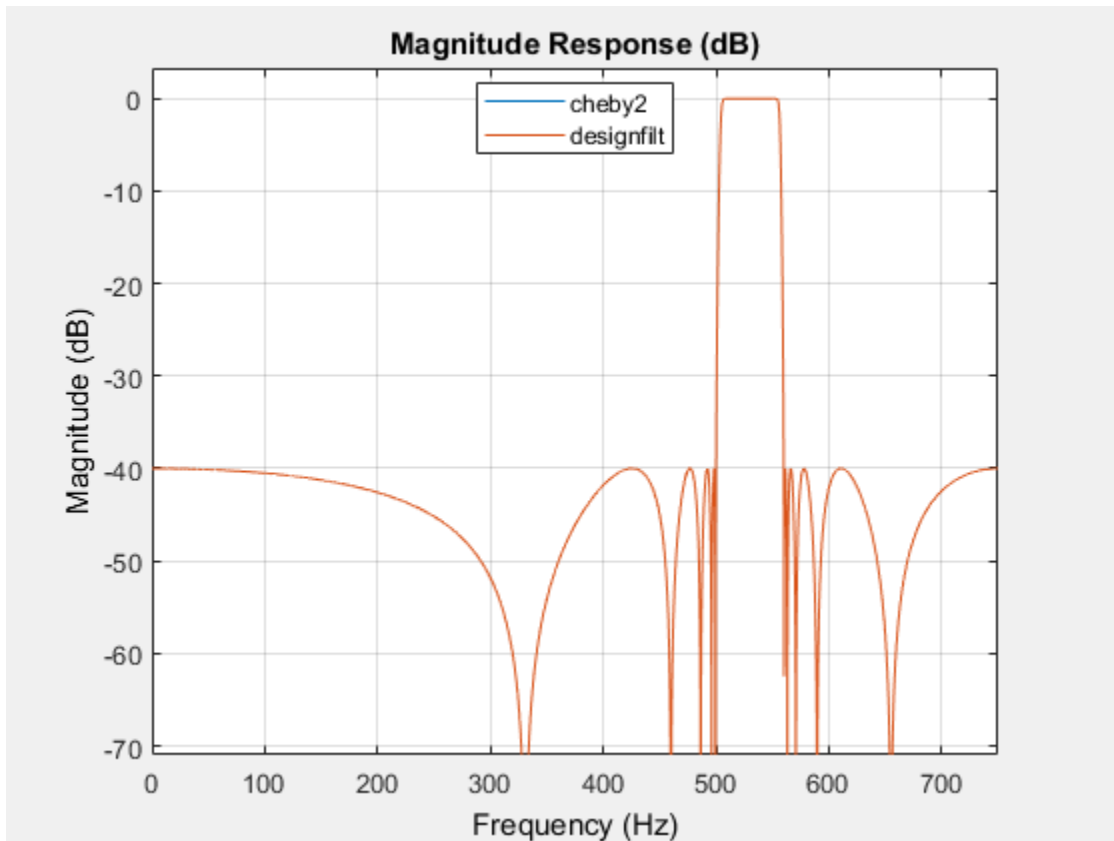

Comparison of Analog IIR Lowpass Filters

Design a 5th-order analog Butterworth lowpass filter with a cutoff frequency of 2 GHz. Multiply by 2π to convert the frequency to radians per second. Compute the frequency response of the filter at 4096 points.

```
n = 5;
f = 2e9;

[zb,pb,kb] = butter(n,2*pi*f,'s');
[bb,ab] = zp2tf(zb,pb,kb);
[hb,wb] = freqs(bb,ab,4096);
```

Design a 5th-order Chebyshev Type I filter with the same edge frequency and 3 dB of passband ripple. Compute its frequency response.

```
[z1,p1,k1] = cheby1(n,3,2*pi*f,'s');
[b1,a1] = zp2tf(z1,p1,k1);
[h1,w1] = freqs(b1,a1,4096);
```

Design a 5th-order Chebyshev Type II filter with the same edge frequency and 30 dB of stopband attenuation. Compute its frequency response.

```
[z2,p2,k2] = cheby2(n,30,2*pi*f,'s');
[b2,a2] = zp2tf(z2,p2,k2);
[h2,w2] = freqs(b2,a2,4096);
```

Design a 5th-order elliptic filter with the same edge frequency, 3 dB of passband ripple, and 30 dB of stopband attenuation. Compute its frequency response.

```
[ze,pe,ke] = ellip(n,3,30,2*pi*f,'s');
[be,ae] = zp2tf(ze,pe,ke);
[he,we] = freqs(be,ae,4096);
```

Plot the attenuation in decibels. Express the frequency in gigahertz. Compare the filters.

```
plot(wb/(2e9*pi),mag2db(abs(hb)))
hold on
plot(w1/(2e9*pi),mag2db(abs(h1)))
plot(w2/(2e9*pi),mag2db(abs(h2)))
plot(we/(2e9*pi),mag2db(abs(he)))
axis([0 4 -40 5])
grid
xlabel('Frequency (GHz)')
ylabel('Attenuation (dB)')
legend('butter','cheby1','cheby2','ellip')
```

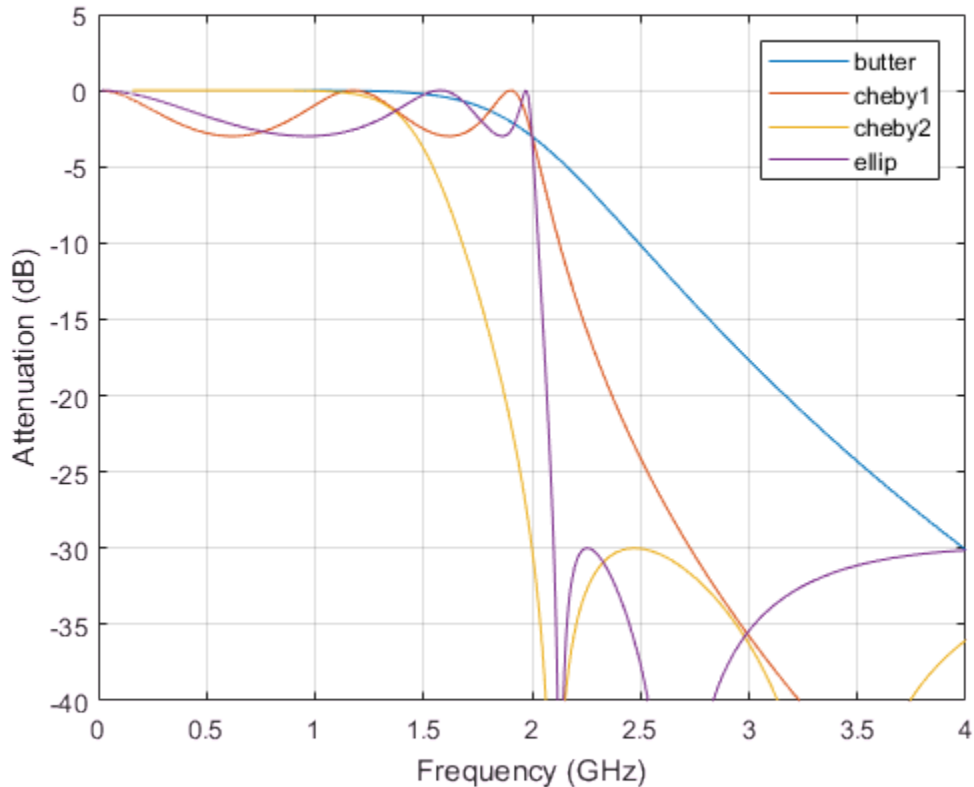

The Butterworth and Chebyshev Type II filters have flat passbands and wide transition bands. The Chebyshev Type I and elliptic filters roll off faster but have passband ripple. The frequency input to the Chebyshev Type II design function sets the beginning of the stopband rather than the end of the passband.

Input Arguments

n — Filter order
integer scalar

Filter order, specified as an integer scalar.

Data Types: double

Rs — Stopband attenuation

positive scalar

Stopband attenuation down from the peak passband value, specified as a positive scalar expressed in decibels.

If your specification, ℓ , is in linear units, you can convert it to decibels using $RS = -20 \log_{10}\ell$.

Data Types: double

Ws — Stopband edge frequency

scalar | two-element vector

Stopband edge frequency, specified as a scalar or a two-element vector. The stopband edge frequency is the frequency at which the magnitude response of the filter is $-RS$ decibels. Larger values of stopband attenuation, RS , result in wider transition bands.

- If WS is a scalar, then `cheby2` designs a lowpass or highpass filter with edge frequency WS .

If WS is the two-element vector $[w1 \ w2]$, where $w1 < w2$, then `cheby2` designs a bandpass or bandstop filter with lower edge frequency $w1$ and higher edge frequency $w2$.

- For digital filters, the stopband edge frequencies must lie between 0 and 1, where 1 corresponds to the Nyquist rate—half the sample rate or π rad/sample.

For analog filters, the stopband edge frequencies must be expressed in radians per second and can take on any positive value.

Data Types: double

f type — Filter type

'low' | 'bandpass' | 'high' | 'stop'

Filter type, specified as one of the following:

- 'low' specifies a lowpass filter with stopband edge frequency WS . 'low' is the default for scalar WS .
- 'high' specifies a highpass filter with stopband edge frequency WS .

- 'bandpass' specifies a bandpass filter of order $2n$ if Ws is a two-element vector. 'bandpass' is the default when Ws has two elements.
- 'stop' specifies a bandstop filter of order $2n$ if Ws is a two-element vector.

Data Types: char

Output Arguments

b, a — Transfer function coefficients

row vectors

Transfer function coefficients of the filter, returned as row vectors of length $n + 1$ for lowpass and highpass filters and $2n + 1$ for bandpass and bandstop filters.

- For digital filters, the transfer function is expressed in terms of **b** and **a** as

$$H(z) = \frac{B(z)}{A(z)} = \frac{b(1) + b(2)z^{-1} + \dots + b(n+1)z^{-n}}{a(1) + a(2)z^{-1} + \dots + a(n+1)z^{-n}}.$$

- For analog filters, the transfer function is expressed in terms of **b** and **a** as

$$H(s) = \frac{B(s)}{A(s)} = \frac{b(1)s^n + b(2)s^{n-1} + \dots + b(n+1)}{a(1)s^n + a(2)s^{n-1} + \dots + a(n+1)}.$$

Data Types: double

z, p, k — Zeros, poles, and gain

column vectors, scalar

Zeros, poles, and gain of the filter, returned as two column vectors of length n ($2n$ for bandpass and bandstop designs) and a scalar.

- For digital filters, the transfer function is expressed in terms of **z**, **p**, and **k** as

$$H(z) = k \frac{(1 - z(1)z^{-1})(1 - z(2)z^{-1}) \dots (1 - z(n)z^{-1})}{(1 - p(1)z^{-1})(1 - p(2)z^{-1}) \dots (1 - p(n)z^{-1})}.$$

- For analog filters, the transfer function is expressed in terms of **z**, **p**, and **k** as

$$H(s) = k \frac{(s - z(1))(s - z(2)) \cdots (s - z(n))}{(s - p(1))(s - p(2)) \cdots (s - p(n))}.$$

Data Types: double

A, B, C, D — State-space matrices matrices

State-space representation of the filter, returned as matrices. If $m = n$ for lowpass and highpass designs and $m = 2n$ for bandpass and bandstop filters, then **A** is $m \times m$, **B** is $m \times 1$, **C** is $1 \times m$, and **D** is 1×1 .

- For digital filters, the state-space matrices relate the state vector x , the input u , and the output y through

$$\begin{aligned}x(k+1) &= A x(k) + B u(k) \\ y(k) &= C x(k) + D u(k).\end{aligned}$$

- For analog filters, the state-space matrices relate the state vector x , the input u , and the output y through

$$\begin{aligned}\dot{x} &= A x + B u \\ y &= C x + D u.\end{aligned}$$

Data Types: double

Definitions

Limitations

Numerical Instability of Transfer Function Syntax

In general, use the `[z, p, k]` syntax to design IIR filters. To analyze or implement your filter, you can then use the `[z, p, k]` output with `zp2sos`. If you design the filter using the `[b, a]` syntax, you might encounter numerical problems. These problems are due to round-off errors and can occur for n as low as 4. The following example illustrates this limitation.

```
n = 6;
```

```

Rs = 80;
Wn = [2.5e6 29e6]/500e6;
ftype = 'bandpass';

% Transfer function design
[b,a] = cheby2(n,Rs,Wn,ftype);      % This filter is unstable

% Zero-pole-gain design
[z,p,k] = cheby2(n,Rs,Wn,ftype);
sos = zp2sos(z,p,k);

% Plot and compare the results
hfvt = fvtool(b,a,sos,'FrequencyScale','log');
legend(hfvt,'TF Design','ZPK Design')

```

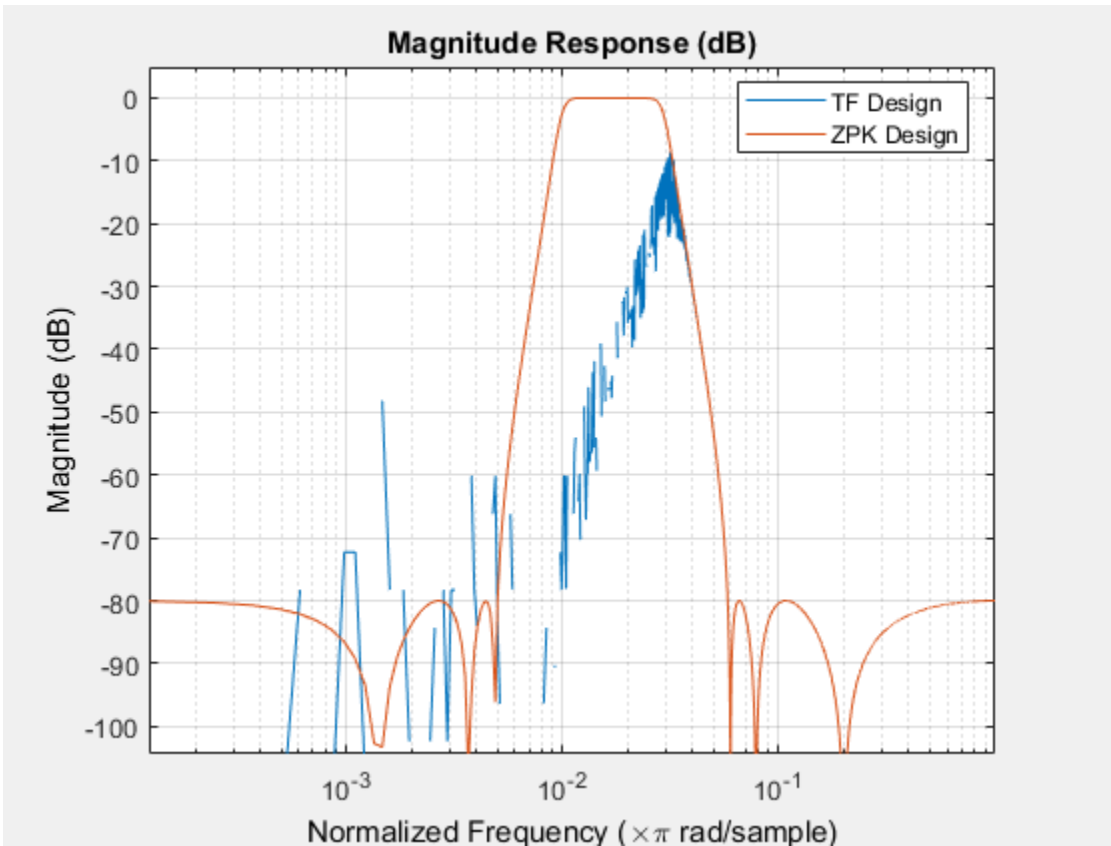

Algorithms

Chebyshev Type II filters are monotonic in the passband and equiripple in the stopband. Type II filters do not roll off as fast as Type I filters, but are free of passband ripple.

`cheby2` uses a five-step algorithm:

- 1 It finds the lowpass analog prototype poles, zeros, and gain using the function `cheb2ap`.
- 2 It converts poles, zeros, and gain into state-space form.
- 3 If required, it uses a state-space transformation to convert the lowpass filter into a bandpass, highpass, or bandstop filter with the desired frequency constraints.
- 4 For digital filter design, it uses `bilinear` to convert the analog filter into a digital filter through a bilinear transformation with frequency prewarping. Careful frequency adjustment the analog filters and the digital filters to have the same frequency response magnitude at ω_s or ω_1 and ω_2 .
- 5 It converts the state-space filter back to transfer function or zero-pole-gain form, as required.

Extended Capabilities

C/C++ Code Generation

Generate C and C++ code using MATLAB® Coder™.

Usage notes and limitations:

All inputs must be constants. Expressions or variables are allowed if their values do not change.

See Also

See Also

`besself` | `butter` | `cheb1ord` | `cheb2ap` | `cheby1` | `designfilt` | `ellip` | `filter`
| `sosfilt`

Introduced before R2006a

chirp

Swept-frequency cosine

Syntax

```
y = chirp(t,f0,t1,f1)
y = chirp(t,f0,t1,f1,'method')
y = chirp(t,f0,t1,f1,'method',phi)
y = chirp(t,f0,t1,f1,'quadratic',phi,'shape')
```

Description

`y = chirp(t,f0,t1,f1)` generates samples of a linear swept-frequency cosine signal at the time instances defined in array `t`, where `f0` is the instantaneous frequency at time 0, and `f1` is the instantaneous frequency at time `t1`. `f0` and `f1` are both in hertz. If unspecified, `f0` is e^{-6} for logarithmic chirp and 0 for all other methods, `t1` is 1, and `f1` is 100.

`y = chirp(t,f0,t1,f1,'method')` specifies alternative sweep method options, where `method` can be:

- `linear`, which specifies an instantaneous frequency sweep $f_i(t)$ given by

$$f_i(t) = f_0 + \beta t$$

where

$$\beta = (f_1 - f_0) / t_1$$

and the default value for f_0 is 0. β ensures that the desired frequency breakpoint f_1 at time t_1 is maintained.

- `quadratic`, which specifies an instantaneous frequency sweep $f_i(t)$ given by

$$f_i(t) = f_0 + \beta t^2$$

where

$$\beta = (f_1 - f_0) / t_1^2$$

and the default value for f_0 is 0. If $f_0 > f_1$ (downsweep), the default shape is convex. If $f_0 < f_1$ (upsweep), the default shape is concave.

- **logarithmic** specifies an instantaneous frequency sweep $f_i(t)$ given by

$$f_i(t) = f_0 \times \beta^t$$

where

$$\beta = \left(\frac{f_1}{f_0} \right)^{\frac{1}{t_1}}$$

and the default value for f_0 is $1e^{-6}$. Both an upsweep ($f_1 > f_0$) and a downsweep ($f_0 > f_1$) of frequency is possible.

Each of the above methods can be entered as 'li', 'q', and 'lo', respectively.

`y = chirp(t,f0,t1,f1,'method',phi)` allows an initial phase `phi` to be specified in degrees. If unspecified, `phi` is 0. Default values are substituted for empty or omitted trailing input arguments.

`y = chirp(t,f0,t1,f1,'quadratic',phi,'shape')` specifies the shape of the quadratic swept-frequency signal's spectrogram. `shape` is either **concave** or **convex**, which describes the shape of the parabola in the positive frequency axis. If `shape` is omitted, the default is convex for downsweep ($f_0 > f_1$) and is concave for upsweep ($f_0 < f_1$).



Convex downsweep shape

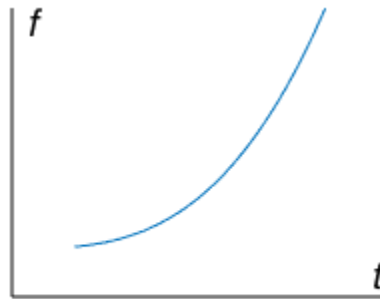

Concave upsweep shape

Examples

Linear Chirp

Generate a chirp with linear instantaneous frequency deviation. The chirp is sampled at 1 kHz for 2 seconds. The instantaneous frequency is 0 at $t = 0$ and crosses 250 Hz at $t = 1$ second.

```
t = 0:1/1e3:2;  
y = chirp(t,0,1,250);
```

Compute and plot the spectrogram of the chirp. Specify 256 DFT points, a Hamming window of the same length, and 250 samples of overlap.

```
spectrogram(y,256,250,256,1e3, 'yaxis')
```

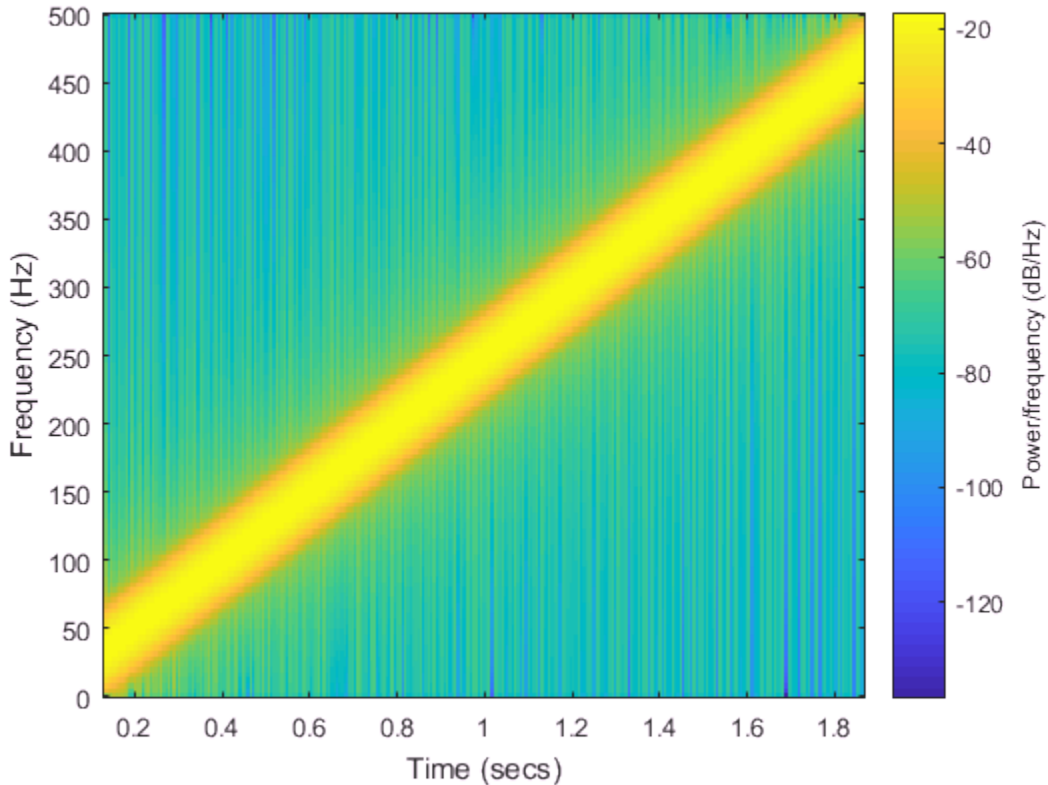

Quadratic Chirp

Generate a chirp with quadratic instantaneous frequency deviation. The chirp is sampled at 1 kHz for 2 seconds. The instantaneous frequency is 100 Hz at $t = 0$ and crosses 200 Hz at $t = 1$ second.

```
t = 0:1/1e3:2;  
y = chirp(t,100,1,200,'quadratic');
```

Compute and plot the spectrogram of the chirp. Specify 128 DFT points, a Hamming window of the same length, and 120 samples of overlap.

```
spectrogram(y,128,120,128,1e3,'yaxis')
```

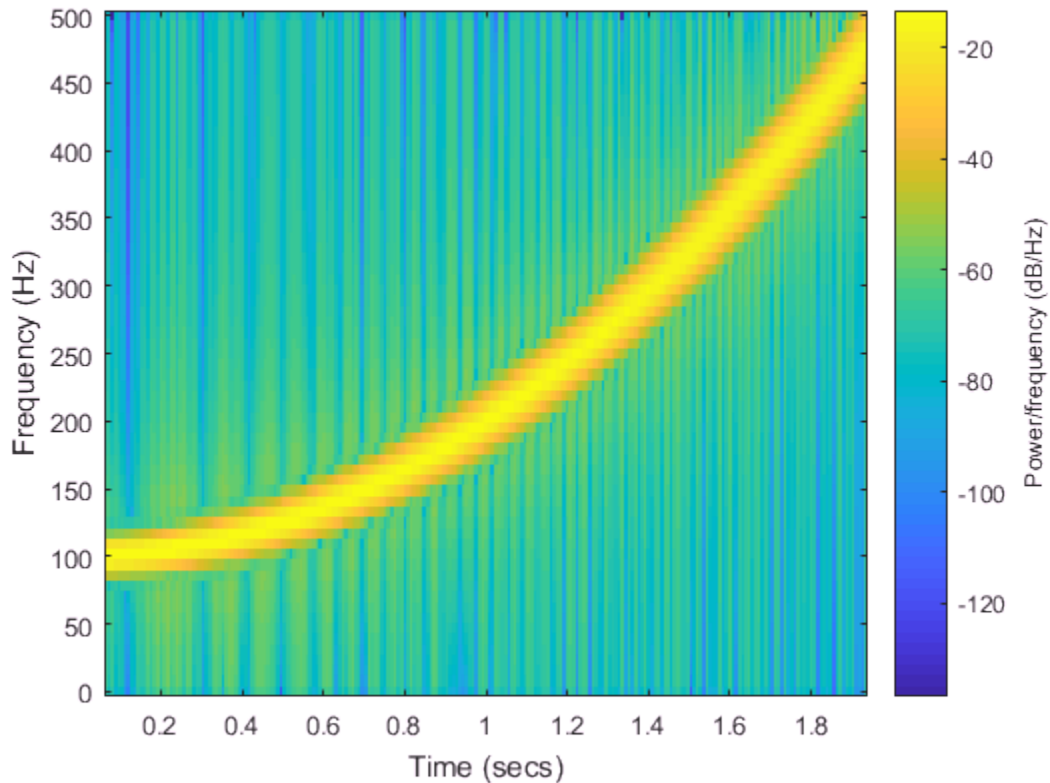

Convex Quadratic Chirp

Generate a convex quadratic chirp sampled at 1 kHz for 2 seconds. The instantaneous frequency is 400 Hz at $t = 0$ and crosses 300 Hz at $t = 1$ second.

```
t = 0:1/1e3:2;  
fo = 400;  
f1 = 300;  
y = chirp(t,fo,1,f1,'quadratic',[],'convex');
```

Compute and plot the spectrogram of the chirp. Specify 256 DFT points, a Hamming window of the same length, and 200 samples of overlap.

```
spectrogram(y,256,200,256,1e3, 'yaxis')
```

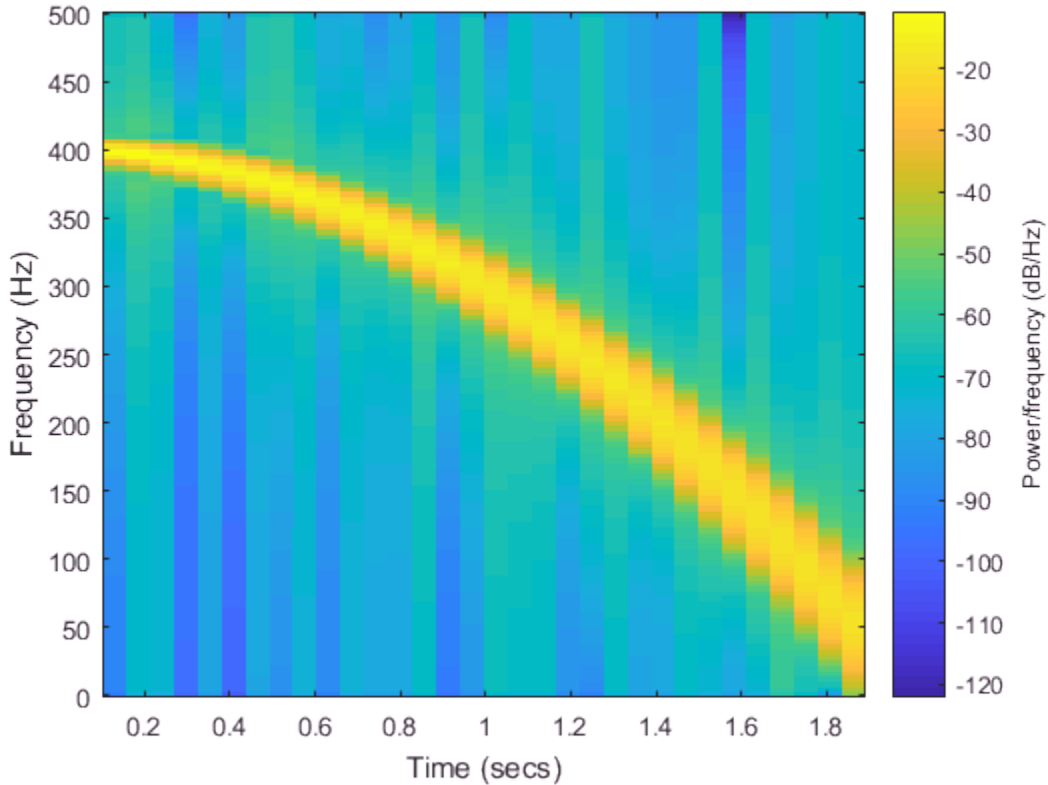

Symmetric Concave Quadratic Chirp

Generate a concave quadratic chirp sampled at 1 kHz for 4 seconds. Specify the time vector so that the instantaneous frequency is symmetric about the halfway point of the sampling interval, with a minimum frequency of 100 Hz and a maximum frequency of 500 Hz.

```
t = -2:1/1e3:2;  
fo = 100;  
f1 = 200;  
y = chirp(t,fo,1,f1,'quadratic',[],'concave');
```

Compute and plot the spectrogram of the chirp. Specify 128 DFT points, a Hann window of the same length, and 120 samples of overlap. Note that the spectrogram function measures time starting at $t = 0$;

```
spectrogram(y,hann(128),120,128,1e3,'yaxis')
```

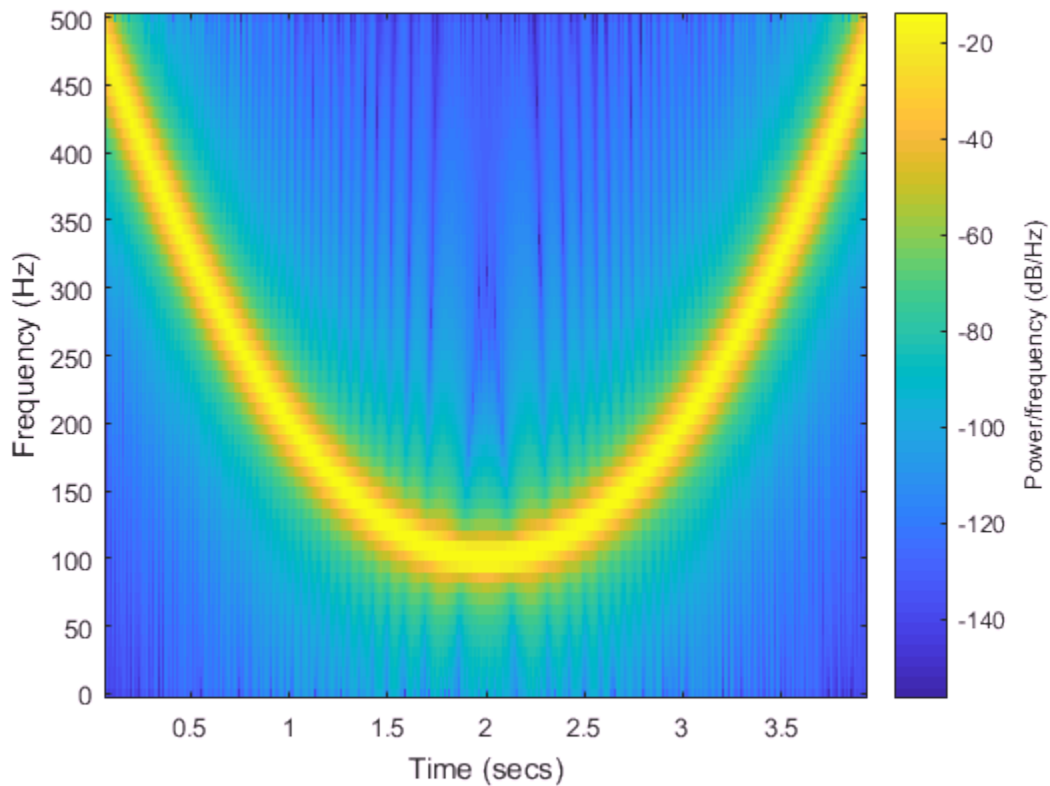

Logarithmic Chirp

Generate a logarithmic chirp sampled at 1 kHz for 10 seconds. The instantaneous frequency is 10 Hz initially and 400 Hz at the end.

```
t = 0:1/1e3:10;  
fo = 10;
```

```
f1 = 400;  
y = chirp(t,fo,10,f1,'logarithmic');
```

Compute and plot the spectrogram of the chirp. Specify 256 DFT points, a Hamming window of the same length, and 200 samples of overlap.

```
spectrogram(y,256,200,256,1e3,'yaxis')
```

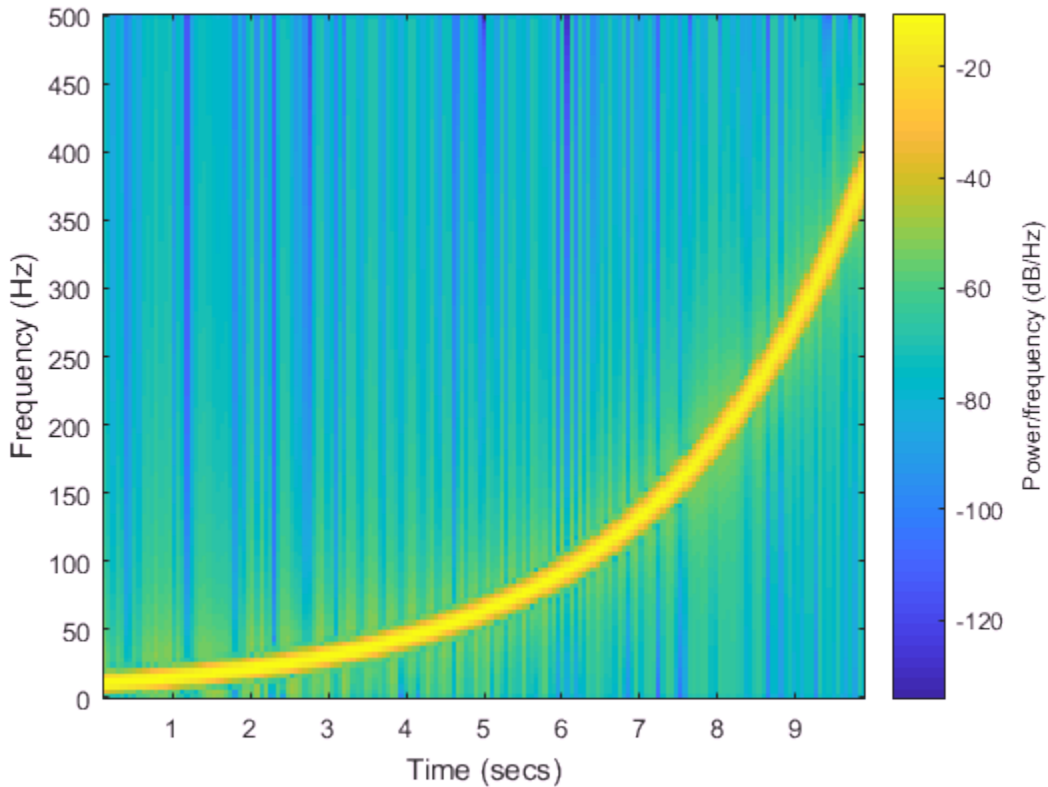

See Also

cos | diric | gauspuls | pulstran | rectpuls | sawtooth | sin | sinc | square
| tripuls

Introduced before R2006a

convmtx

Convolution matrix

Syntax

```
A = convmtx(h,n)
```

Description

`A = convmtx(h,n)` returns the convolution matrix, **A**, such that the product of **A** and a vector, **x**, is the convolution of **h** and **x**.

- If **h** is a column vector of length **m**, **A** is $(m+n-1)$ -by-**n** and the product of **A** and a column vector, **x**, of length **n** is the convolution of **h** and **x**.
- If **h** is a row vector of length **m**, **A** is **n**-by- $(m+n-1)$ and the product of a row vector, **x**, of length **n** with **A** is the convolution of **h** and **x**.

`convmtx` handles edge conditions by zero padding.

Examples

Efficient Computation of Convolution

It is generally more efficient to compute a convolution using `conv` when the signals are vectors. For multichannel signals, `convmtx` might be more efficient.

Compute the convolution of two random vectors, **a** and **b**, using both `conv` and `convmtx`. The signals have 1000 samples each. Compare the time spent by the two functions. Eliminate random fluctuations by repeating the calculation 30 times and averaging.

```
Nt = 30;  
Na = 1000;  
Nb = 1000;
```

```
tcnv = 0;  
tmtx = 0;
```

```

for kj = 1:Nt
    a = randn(Na,1);
    b = randn(Nb,1);

    tic
    n = conv(a,b);
    tcnv = tcnv+toc;

    tic
    c = convmtx(b,Na);
    d = c*a;
    tmtx = tmtx+toc;
end

t1col = [tcnv tmtx]/Nt

t1col =

    0.0011    0.0179

```

```

t1rat = tcnv\tmtx
t1rat = 16.7304

```

conv is about two orders of magnitude more efficient.

Repeat the exercise for the case where **a** is a multichannel signal with 1000 channels. Optimize conv's performance by preallocating.

```

Nchan = 1000;

tcnv = 0;
tmtx = 0;

n = zeros(Na+Nb-1,Nchan);

for kj = 1:Nt
    a = randn(Na,Nchan);
    b = randn(Nb,1);

    tic
    for k = 1:Nchan
        n(:,k) = conv(a(:,k),b);
    end
end

```

```
end
tcnv = tcnv+toc;

tic
c = convmtx(b,Na);
d = c*a;
tmtx = tmtx+toc;
end

tmcol = [tcnv tmtx]/Nt
tmcol =

    0.8457    0.0716

tmrat = tcnv/tmtx
tmrat = 11.8092

convmtx is about 3 times as efficient as conv.
```

Algorithms

convmtx uses the function `toeplitz` to generate the convolution matrix.

Extended Capabilities

C/C++ Code Generation

Generate C and C++ code using MATLAB® Coder™.

See Also

See Also

`conv` | `conv2` | `convn` | `corrmtx` | `dftmtx`

Introduced before R2006a

corrmtx

Data matrix for autocorrelation matrix estimation

Syntax

```
X = corrmtx(x,m)
X = corrmtx(x,m,'method')
[X,R] = corrmtx(...)
```

Description

`X = corrmtx(x,m)` returns an $(n + m)$ -by- $(m + 1)$ rectangular Toeplitz matrix X , such that $X'X$ is a (biased) estimate of the autocorrelation matrix for the length- n data vector x . m must be a positive integer strictly smaller than the length of the input x .

`X = corrmtx(x,m,'method')` computes the matrix X according to the method specified by `'method'`:

- `'autocorrelation'`: (default) X is the $(n + m)$ -by- $(m + 1)$ rectangular Toeplitz matrix that generates an autocorrelation estimate for the length- n data vector x , derived using *prewindowed* and *postwindowed* data, based on an m th-order prediction error model.
- `'prewindowed'`: X is the n -by- $(m + 1)$ rectangular Toeplitz matrix that generates an autocorrelation estimate for the length- n data vector x , derived using *prewindowed* data, based on an m th-order prediction error model.
- `'postwindowed'`: X is the n -by- $(m + 1)$ rectangular Toeplitz matrix that generates an autocorrelation estimate for the length- n data vector x , derived using *postwindowed* data, based on an m th-order prediction error model.
- `'covariance'`: X is the $(n - m)$ -by- $(m + 1)$ rectangular Toeplitz matrix that generates an autocorrelation estimate for the length- n data vector x , derived using *nonwindowed* data, based on an m th-order prediction error model.
- `'modified'`: X is the $2(n - m)$ -by- $(m + 1)$ modified rectangular Toeplitz matrix that generates an autocorrelation estimate for the length- n data vector x , derived using forward and backward prediction error estimates, based on an m th-order prediction error model.

`[X,R] = corrmtx(...)` also returns the $(m + 1)$ -by- $(m + 1)$ autocorrelation matrix estimate R , calculated as $X' * X$.

Examples

Modified Data and Autocorrelation Matrices

Generate a signal composed of three complex exponentials embedded in white Gaussian noise. Compute the data and autocorrelation matrices using the 'modified' method.

```
n = 0:99;
s = exp(i*pi/2*n)+2*exp(i*pi/4*n)+exp(i*pi/3*n)+randn(1,100);
m = 12;
[X,R] = corrmtx(s,m,'modified');
```

Plot the real and imaginary parts of the autocorrelation matrix.

```
[A,B] = ndgrid(1:m+1);
subplot(2,1,1)
plot3(A,B,real(R))
title('Re(R)')
subplot(2,1,2)
plot3(A,B,imag(R))
title('Im(R)')
```

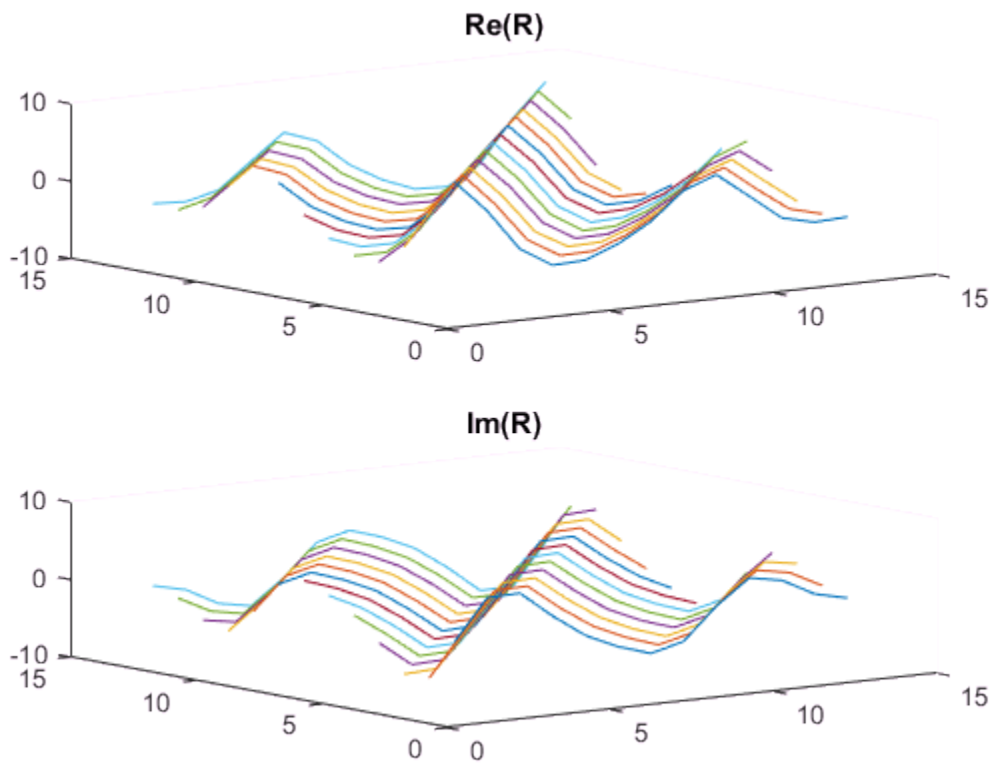

Algorithms

The Toeplitz data matrix computed by `corrmtx` depends on the method you select. The matrix determined by the autocorrelation (default) method is given by the following matrix.

$$X = \begin{bmatrix} x(1) & \cdots & 0 \\ \vdots & \ddots & \vdots \\ \hline x(m+1) & \cdots & x(1) \\ \vdots & \ddots & \vdots \\ x(n-m) & \cdots & x(m+1) \\ \vdots & \ddots & \vdots \\ \hline x(n) & \cdots & x(n-m) \\ \vdots & \ddots & \vdots \\ \hline 0 & \cdots & x(n) \end{bmatrix}$$

In this matrix, m is the same as the input argument `m` to `corrmtx`, and n is `length(x)`. Variations of this matrix are used to return the output X of `corrmtx` for each method:

- 'autocorrelation' — (default) $X = X$, above.
- 'prewindowed' — X is the n -by- $(m+1)$ submatrix of X whose first row is $[x(1) \dots 0]$ and whose last row is $[x(n) \dots x(n-m)]$.
- 'postwindowed' — X is the n -by- $(m+1)$ submatrix of X whose first row is $[x(m+1) \dots x(1)]$ and whose last row is $[0 \dots x(n)]$
- 'covariance' — X is the $(n-m)$ -by- $(m+1)$ submatrix of X whose first row is $[x(m+1) \dots x(1)]$ and whose last row is $[x(n) \dots x(n-m)]$.
- 'modified' — X is the $2(n-m)$ -by- $(m+1)$ matrix X_{mod} shown below.

$$X_{\text{mod}} = \begin{bmatrix} x(m+1) & \cdots & x(1) \\ \vdots & \ddots & \vdots \\ x(n-m) & \cdots & x(m+1) \\ \vdots & \ddots & \vdots \\ x(n) & \cdots & x(n-m) \\ \hline x^*(1) & \cdots & x^*(m+1) \\ \vdots & \ddots & \vdots \\ x^*(m+1) & \cdots & x^*(n-m) \\ \vdots & \ddots & \vdots \\ \hline x^*(n-m) & \cdots & x^*(n) \end{bmatrix}$$

References

- [1] Marple, S. Lawrence. *Digital Spectral Analysis*. Englewood Cliffs, NJ: Prentice-Hall, 1987.

Extended Capabilities

C/C++ Code Generation

Generate C and C++ code using MATLAB® Coder™.

See Also

See Also

`peig` | `pmusic` | `rooteig` | `rootmusic` | `xcorr`

Introduced before R2006a

cpsd

Cross power spectral density

Syntax

```

pxy = cpsd(x,y)

pxy = cpsd(x,y>window)
pxy = cpsd(x,y>window,noverlap)
pxy = cpsd(x,y>window,noverlap,nfft)

pxy = cpsd( ____, 'mimo' )

[pxy,w] = cpsd( ____ )
[pxy,f] = cpsd( ____, fs)

[pxy,w] = cpsd(x,y>window,noverlap,w)
[pxy,f] = cpsd(x,y>window,noverlap,f,fs)

[ ____ ] = cpsd(x,y, ____, freqrange)

cpsd( ____ )

```

Description

`pxy = cpsd(x,y)` estimates the cross power spectral density (CPSD) of two discrete-time signals, `x` and `y`, using Welch's averaged, modified periodogram method of spectral estimation.

- If `x` and `y` are both vectors, they must have the same length.
- If one of the signals is a matrix and the other is a vector, then the length of the vector must equal the number of rows in the matrix. The function expands the vector and returns a matrix of column-by-column cross power spectral density estimates.
- If `x` and `y` are matrices with the same number of rows but different numbers of columns, then `cpsd` returns a three-dimensional array, `pxy`, containing cross power spectral density estimates for all combinations of input columns. Each column of `pxy` corresponds to a column of `x`, and each page corresponds to a column of `y`:

$$pxy(:,m,n) = cpsd(x(:,m),y(:,n)).$$

- If x and y are matrices of equal size, then `cpsd` operates column-wise: `pxy(:,n) = cpsd(x(:,n),y(:,n))`. To obtain a multi-input/multi-output array, append 'mimo' to the argument list.

For real x and y , `cpsd` returns a one-sided CPSD. For complex x or y , `cpsd` returns a two-sided CPSD.

`pxy = cpsd(x,y>window)` uses `window` to divide x and y into segments and perform windowing.

`pxy = cpsd(x,y>window,noverlap)` uses `noverlap` samples of overlap between adjoining segments.

`pxy = cpsd(x,y>window,noverlap,nfft)` uses `nfft` sampling points to calculate the discrete Fourier transform.

`pxy = cpsd(____,'mimo')` computes a multi-input/multi-output array of cross power spectral density estimates. This syntax can include any combination of input arguments from previous syntaxes.

`[pxy,w] = cpsd(____)` returns a vector of normalized frequencies, w , at which the cross power spectral density is estimated.

`[pxy,f] = cpsd(____,fs)` returns a vector of frequencies, f , expressed in terms of the sample rate, fs , at which the cross power spectral density is estimated. fs must be the sixth numeric input to `cpsd`. To input a sample rate and still use the default values of the preceding optional arguments, specify these arguments as empty, `[]`.

`[pxy,w] = cpsd(x,y>window,noverlap,w)` returns the cross power spectral density estimates at the normalized frequencies specified in w .

`[pxy,f] = cpsd(x,y>window,noverlap,f,fs)` returns the cross power spectral density estimates at the frequencies specified in f .

`[____] = cpsd(x,y,____,freqrange)` returns the cross power spectral density estimate over the frequency range specified by `freqrange`. Valid options for `freqrange` are 'onesided', 'twosided', and 'centered'.

`cpsd(____)` with no output arguments plots the cross power spectral density estimate in the current figure window.

Examples

Cross Power Spectral Density of Colored Noise Signals

Generate two colored noise signals and plot their cross power spectral density. Specify a length-1024 FFT and a 500-point triangular window with no overlap.

```
r = randn(16384,1);  
  
hx = fir1(30,0.2,rectwin(31));  
x = filter(hx,1,r);  
  
hy = ones(1,10)/sqrt(10);  
y = filter(hy,1,r);  
  
cpsd(x,y,triang(500),250,1024)
```

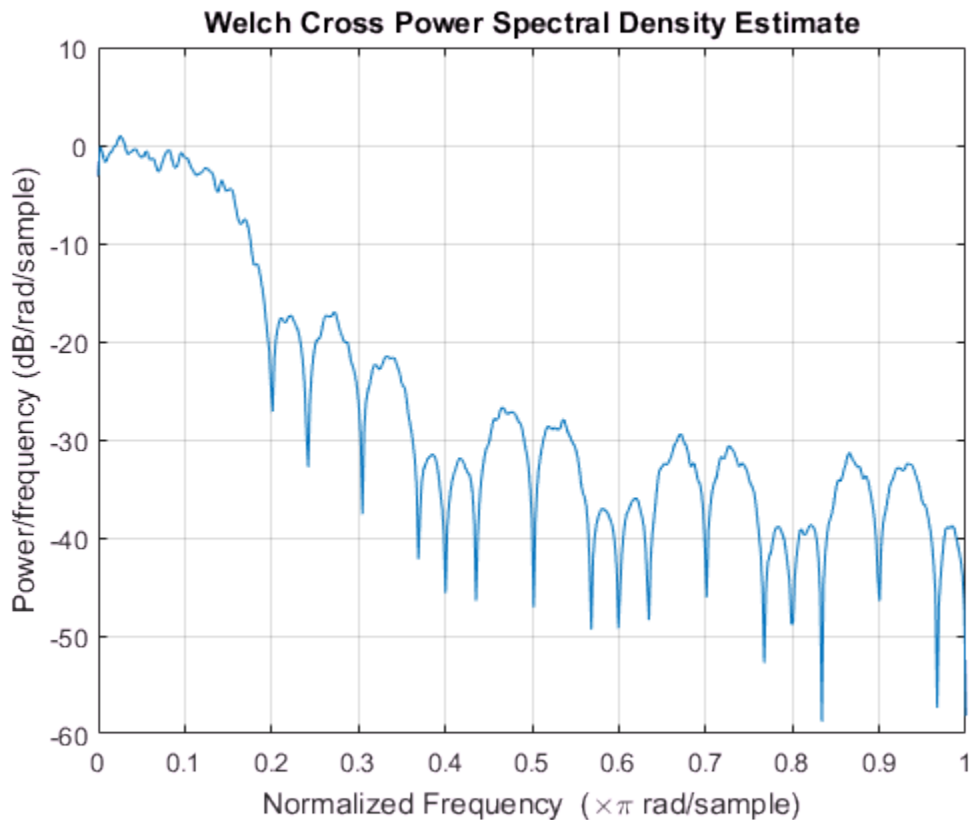

SISO and MIMO Cross Power Spectral Densities

Generate two two-channel sinusoids sampled at 1 kHz for 1 second. The channels of the first signal have frequencies of 200 Hz and 300 Hz. The channels of the second signal have frequencies of 300 Hz and 400 Hz. Both signals are embedded in unit-variance white Gaussian noise.

```
fs = 1e3;  
t = (0:1/fs:1-1/fs)';  
  
q = 2*sin(2*pi*[200 300].*t);  
q = q+randn(size(q));
```

```
r = 2*sin(2*pi*[300 400].*t);  
r = r+randn(size(r));
```

Compute the cross spectral power density of the two signals. Use a 256-sample Bartlett window to divide the signals into segments and window the segments. Specify 128 samples of overlap between adjoining segments and 2048 DFT points. Use the built-in functionality of `cpsd` to plot the result.

```
cpsd(q,r,bartlett(256),128,2048,fs)
```

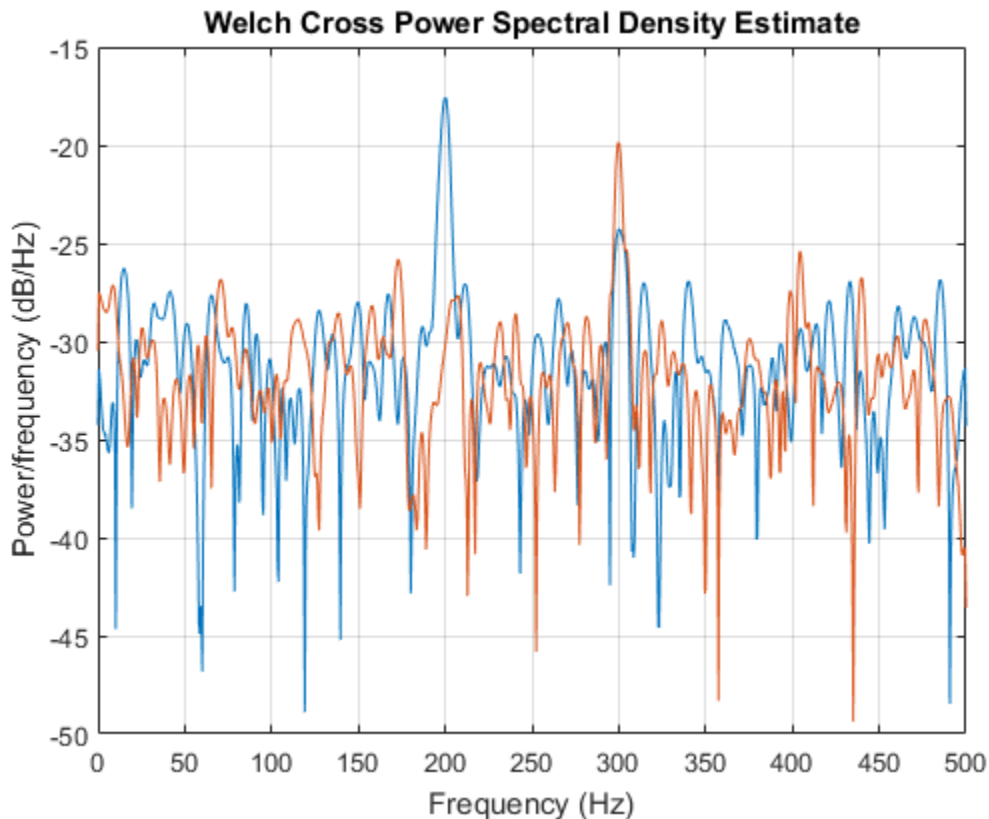

By default, `cpsd` works column-by-column on matrix inputs of the same size. Each channel peaks at the frequencies of the original sinusoids.

Repeat the calculation, but now append 'mimo' to the list of arguments.

```
cpsd(q,r,bartlett(256),128,2048,fs,'mimo')
```

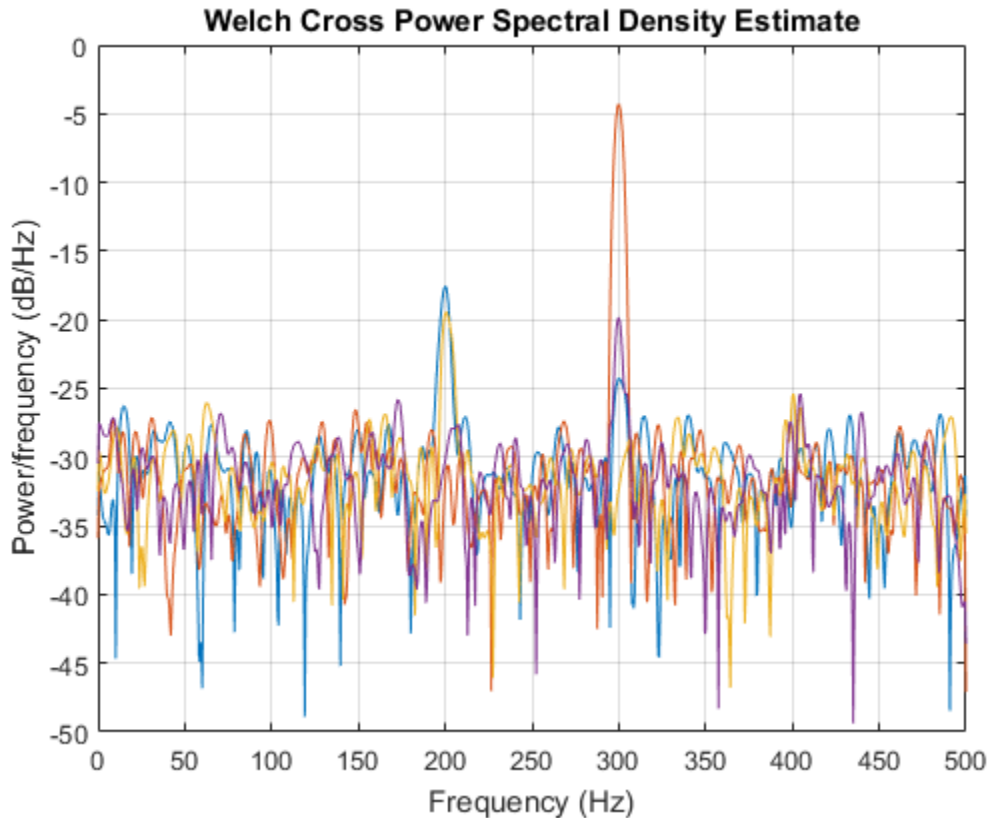

When called with the 'mimo' option, `cpsd` returns a three-dimensional array containing cross power spectral density estimates for all combinations of input columns. The estimate of the second channel of `q` and the first channel of `r` shows an enhanced peak at the common frequency of 300 Hz.

Cross Spectrum Phase of Lagged Sinusoids

Generate two 100 Hz sinusoidal signals sampled at 1 kHz for 296 ms. One of the sinusoids lags the other by 2.5 ms, equivalent to a phase lag of $\pi/2$. Both signals are embedded in white Gaussian noise of variance $1/4^2$.

```
Fs = 1000;  
t = 0:1/Fs:0.296;  
  
x = cos(2*pi*t*100)+0.25*randn(size(t));  
tau = 1/400;  
y = cos(2*pi*100*(t-tau))+0.25*randn(size(t));
```

Compute and plot the magnitude of the cross power spectral density. Use the default settings for `cpsd`. The magnitude peaks at the frequency where there is significant coherence between the signals.

```
cpsd(x,y,[],[],[],Fs)
```

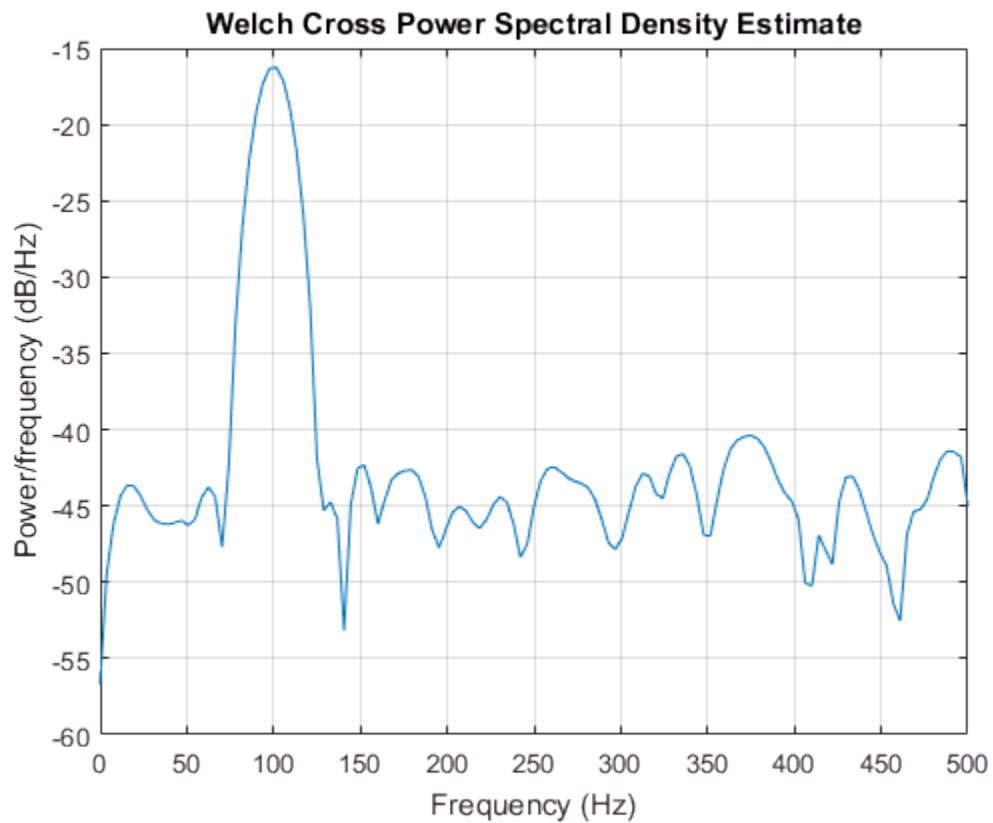

Plot magnitude-squared coherence function and the phase of the cross spectrum. The ordinate at the high-coherence frequency corresponds to the phase lag between the sinusoids.

```
[Cxy,F] = mscohere(x,y,[],[],[],Fs);  
[Pxy,F] = cpsd(x,y,[],[],[],Fs);  
  
subplot(2,1,1)  
plot(F,Cxy)  
title('Magnitude-Squared Coherence')  
  
subplot(2,1,2)  
plot(F,angle(Pxy))  
  
hold on  
plot(F,2*pi*100*tau*ones(size(F)),'--')  
hold off  
  
xlabel('Hz')  
ylabel('\Theta(f)')  
title('Cross Spectrum Phase')
```

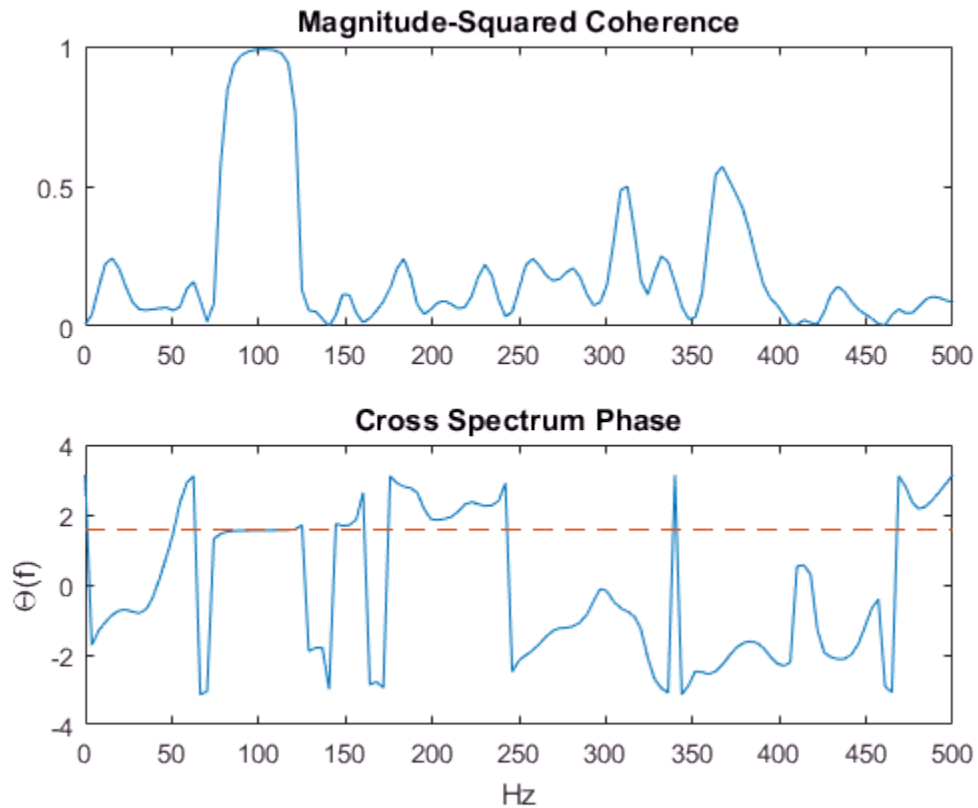

Cross Power Spectral Density of Exponential Sequences

Generate two N -sample exponential sequences, $x_a = a^n$ and $x_b = b^n$, with $n \geq 0$. Specify $a = 0.8$, $b = 0.9$, and a small N to see finite-size effects.

```
N = 10;
n = 0:N-1;
```

```
a = 0.8;
b = 0.9;
```

```
xa = a.^n;
```

```
xb = b.^n;
```

Compute and plot the cross power spectral density of the sequences over the complete interval of normalized frequencies, $[-\pi, \pi]$. Specify a rectangular window of length N and no overlap between segments.

```
w = -pi:1/1000:pi;  
wind = rectwin(N);  
nove = 0;  
  
[pxx, f] = cpsd(xa, xb, wind, nove, w);
```

The cross power spectrum of the two sequences has an analytic expression for large N :

$$R(\omega) = \frac{1}{1 - ae^{-j\omega}} \frac{1}{1 - be^{j\omega}}.$$

Convert this expression to a cross power spectral density by dividing it by $2\pi N$. Compare the results. The ripple in the `cpsd` result is a consequence of windowing.

```
nfac = 2*pi*N;  
  
X = 1./(1-a*exp(-1j*w));  
Y = 1./(1-b*exp( 1j*w));  
R = X.*Y/nfac;  
  
semilogy(f/pi, abs(pxx))  
hold on  
semilogy(w/pi, abs(R))  
hold off  
legend('cpsd', 'Analytic')
```

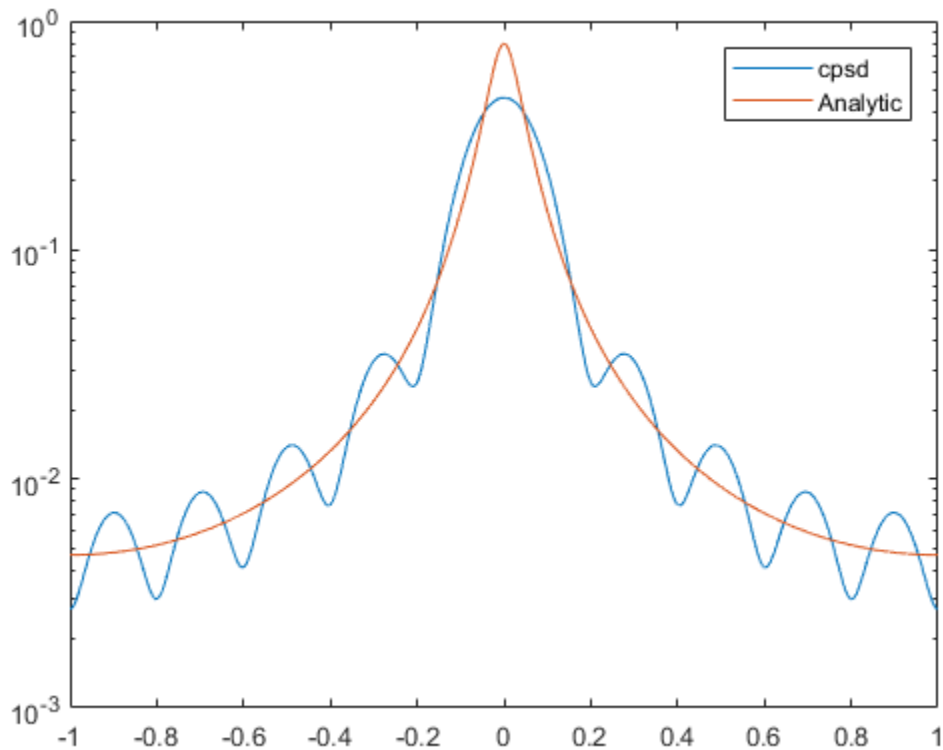

Repeat the calculation with $N = 25$. The curves agree to six figures for N as small as 100.

```

N = 25;
n = 0:N-1;
xa = a.^n;
xb = b.^n;

wind = rectwin(N);

[pxx,f] = cpsd(xa,xb,wind,nove,w);
R = X.*Y/(2*pi*N);

semilogy(f/pi,abs(pxx))

```

```
hold on
semilogy(w/pi,abs(R))
hold off
legend('cpsd','Analytic')
```

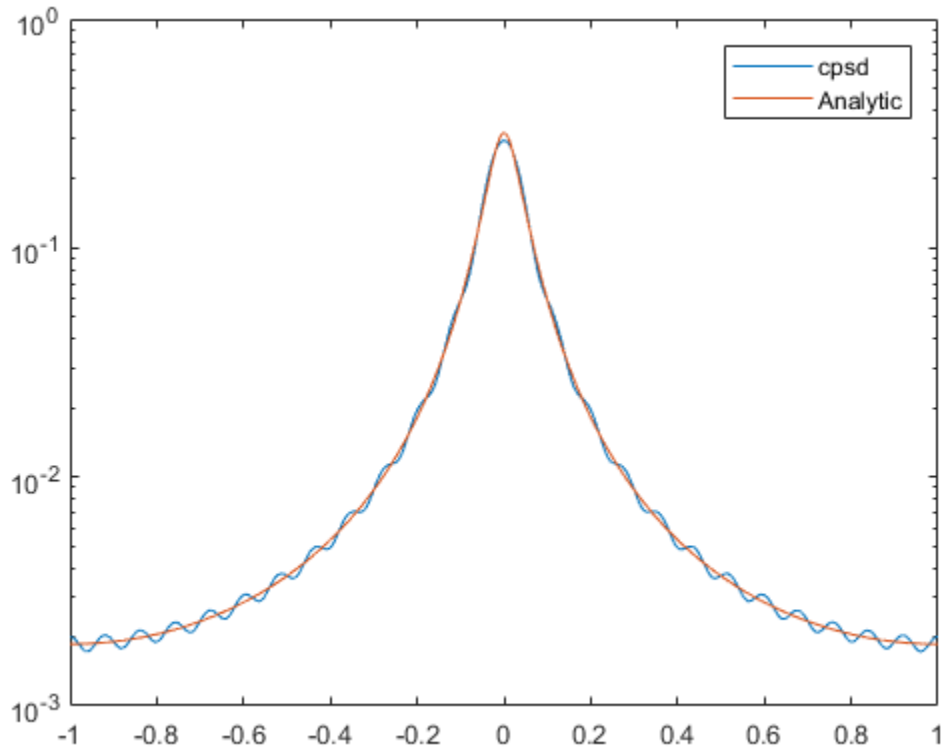

Dial Tone Recognition

Use cross power spectral density to identify a highly corrupted tone.

The sound signals generated when you dial a number or symbol on a digital phone are sums of sinusoids with frequencies taken from two different groups. Each pair of tones contains one frequency of the low group (697 Hz, 770 Hz, 852 Hz, or 941 Hz) and one frequency of the high group (1209 Hz, 1336 Hz, or 1477 Hz).

	1209 Hz	1336 Hz	1477 Hz
697 Hz	1	2	3
770 Hz	4	5	6
852 Hz	7	8	9
941 Hz	*	0	#

Generate signals corresponding to all the symbols. Sample each tone at 4 kHz for half a second. Prepare a reference table.

```

fs = 4e3;
t = 0:1/fs:0.5-1/fs;

nms = ['1'; '2'; '3'; '4'; '5'; '6'; '7'; '8'; '9'; '*'; '0'; '#'];

ver = [697 770 852 941];
hor = [1209 1336 1477];

v = length(ver);
h = length(hor);

for k = 1:v
    for l = 1:h
        idx = h*(k-1)+l;
        tone = sum(sin(2*pi*[ver(k);hor(l)].*t))');
        tones(:,idx) = tone;
    end
end

```

Plot the Welch periodogram of each signal and annotate the component frequencies. Use a 200-sample Hamming window to divide the signals into non-overlapping segments and window the segments.

```

[pxx,f] = pwelch(tones,hamming(200),0,[],fs);

for k = 1:v

```

```

for l = 1:h
    idx = h*(k-1)+1;
    ax = subplot(v,h,idx);
    plot(f,10*log10(pxx(:,idx)))
    ylim([-80 0])
    title(nms(idx))
    tx = [ver(k);hor(l)];
    ax.XTick = tx;
    ax.XTickLabel = int2str(tx);
end
end

```

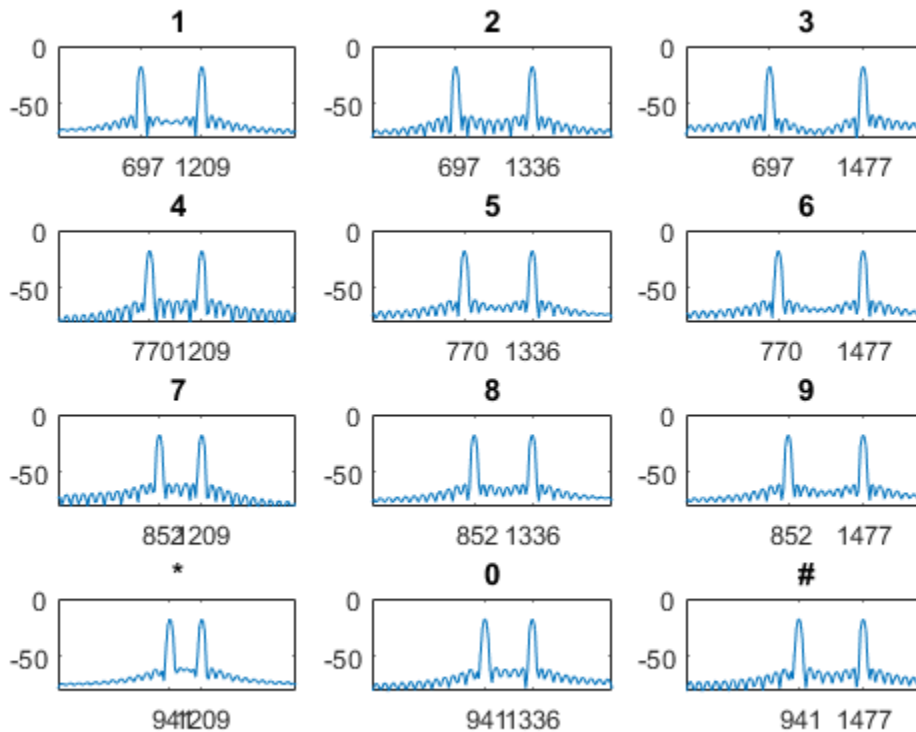

A signal produced by dialing the number 8 is sent through a noisy channel. The received signal is so corrupted that the number cannot be identified by inspection.



```
mys = sum(sin(2*pi*[ver(3);hor(2)].*t))'+5*randn(size(t'));
```

```
% To hear, type soundsc(mys,fs)
```

Compute the cross power spectral density of the corrupted signal and the reference signals. Window the signals using a 512-sample Kaiser window with shape factor $\beta = 5$. Plot the magnitude of each spectrum.

```
[pxy,f] = cpsd(mys,tones,kaiser(512,5),100,[],fs);
```

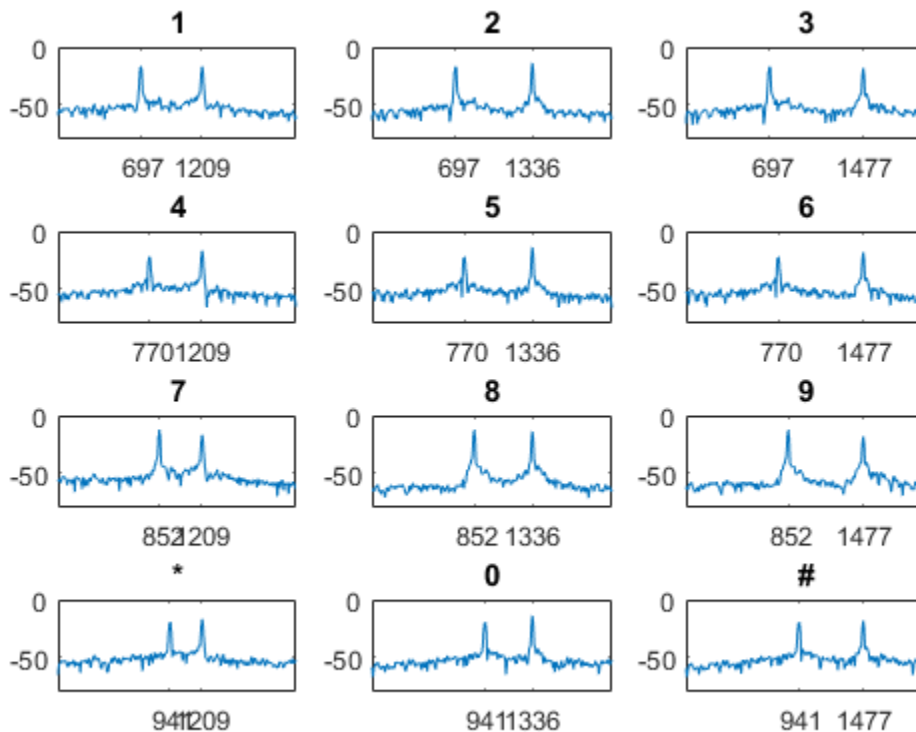
```
for k = 1:v
    for l = 1:h
        idx = h*(k-1)+1;
        ax = subplot(v,h,idx);
        plot(f,10*log10(abs(pxy(:,idx))))
        ylim([-80 0])
        title(nms(idx))
        tx = [ver(k);hor(l)];
        ax.XTick = tx;
        ax.XTickLabel = int2str(tx);
    end
end
```



The digit in the corrupted signal has the spectrum with the highest peaks and the highest RMS value.

```
[~,loc] = max(rms(abs(pxy)));
```

```
digit = nms(loc)
```

```
digit =
```

```
'8'
```

- “Cross Spectrum and Magnitude-Squared Coherence”

Input Arguments

x, y — Input signals

vectors | matrices

Input signals, specified as vectors or matrices.

Example: `cos(pi/4*(0:159))+randn(1,160)` specifies a sinusoid embedded in white Gaussian noise.

Data Types: `single` | `double`

Complex Number Support: Yes

window — Window

integer | vector | []

Window, specified as an integer or as a row or column vector. Use `window` to divide the signal into segments.

- If `window` is an integer, then `cpsd` divides `x` and `y` into segments of length `window` and windows each segment with a Hamming window of that length.
- If `window` is a vector, then `cpsd` divides `x` and `y` into segments of the same length as the vector and windows each segment using `window`.

If the length of `x` and `y` cannot be divided exactly into an integer number of segments with `noverlap` overlapping samples, then the signals are truncated accordingly.

If you specify `window` as empty, then `cpsd` uses a Hamming window such that `x` and `y` are divided into eight segments with `noverlap` overlapping samples.

For a list of available windows, see “Windows”.

Example: `hann(N+1)` and `(1-cos(2*pi*(0:N)'/N))/2` both specify a Hann window of length `N + 1`.

Data Types: `single` | `double`

noverlap — Number of overlapped samples

positive integer | []

Number of overlapped samples, specified as a positive integer.

- If `window` is scalar, then `noverlap` must be smaller than `window`.

- If `window` is a vector, then `noverlap` must be smaller than the length of `window`.

If you specify `noverlap` as empty, then `cpsd` uses a number that produces 50% overlap between segments. If the segment length is unspecified, the function sets `noverlap` to $\lfloor N/4.5 \rfloor$, where N is the length of the input and output signals.

Data Types: `double` | `single`

nfft — Number of DFT points

positive integer | []

Number of DFT points, specified as a positive integer. If you specify `nfft` as empty, then `cpsd` sets the parameter to $\max(256, 2^p)$, where $p = \lceil \log_2 N \rceil$ for input signals of length N .

Data Types: `single` | `double`

fs — Sample rate

positive scalar

Sample rate, specified as a positive scalar. The sample rate is the number of samples per unit time. If the unit of time is seconds, then the sample rate has units of Hz.

w — Normalized frequencies

vector

Normalized frequencies, specified as a row or column vector with at least two elements. Normalized frequencies are in rad/sample.

Example: `w = [pi/4 pi/2]`

Data Types: `double`

f — Frequencies

vector

Frequencies, specified as a row or column vector with at least two elements. The frequencies are in cycles per unit time. The unit time is specified by the sample rate, `fs`. If `fs` has units of samples/second, then `f` has units of Hz.

Example: `fs = 1000; f = [100 200]`

Data Types: `double`

freange — Frequency range for cross power spectral density estimate

'onesided' | 'twosided' | 'centered'

Frequency range for cross power spectral density estimate, specified as `'onesided'`, `'twosided'`, or `'centered'`. The default is `'onesided'` for real-valued signals and `'twosided'` for complex-valued signals.

- `'onesided'` — Returns the one-sided estimate of the cross power spectral density of two real-valued input signals, `x` and `y`. If `nfft` is even, `pxy` has $nfft/2 + 1$ rows and is computed over the interval $[0, \pi]$ rad/sample. If `nfft` is odd, `pxy` has $(nfft + 1)/2$ rows and the interval is $[0, \pi]$ rad/sample. If you specify `fs`, the corresponding intervals are $[0, fs/2]$ cycles/unit time for even `nfft` and $[0, fs/2)$ cycles/unit time for odd `nfft`.
- `'twosided'` — Returns the two-sided estimate of the cross power spectral density of two real-valued or complex-valued input signals, `x` and `y`. In this case, `pxy` has `nfft` rows and is computed over the interval $[0, 2\pi]$ rad/sample. If you specify `fs`, the interval is $[0, fs)$ cycles/unit time.
- `'centered'` — Returns the centered two-sided estimate of the cross power spectral density of two real-valued or complex-valued input signals, `x` and `y`. In this case, `pxy` has `nfft` rows and is computed over the interval $(-\pi, \pi]$ rad/sample for even `nfft` and $(-\pi, \pi)$ rad/sample for odd `nfft`. If you specify `fs`, the corresponding intervals are $(-fs/2, fs/2]$ cycles/unit time for even `nfft` and $(-fs/2, fs/2)$ cycles/unit time for odd `nfft`.

Data Types: char

Output Arguments

pxy — Cross power spectral density

vector | matrix | three-dimensional array

Cross power spectral density, returned as a vector, matrix, or three-dimensional array.

w — Normalized frequencies

vector

Normalized frequencies, returned as a real-valued column vector.

- If `pxy` is one-sided, `w` spans the interval $[0, \pi]$ when `nfft` is even and $[0, \pi)$ when `nfft` is odd.
- If `pxy` is two-sided, `w` spans the interval $[0, 2\pi)$.

- If `pxy` is DC-centered, `w` spans the interval $(-\pi, \pi]$ when `nfft` is even and $(-\pi, \pi)$ when `nfft` is odd.

Data Types: `double` | `single`

f — Frequencies

vector

Frequencies, returned as a real-valued column vector.

Data Types: `double` | `single`

Definitions

Cross Power Spectral Density

The cross power spectral density is the distribution of power per unit frequency and is defined as

$$P_{xy}(\omega) = \sum_{m=-\infty}^{\infty} R_{xy}(m)e^{-j\omega m}.$$

The cross-correlation sequence is defined as

$$R_{xy}(m) = E\{x_{n+m}y_n^*\} = E\{x_n y_{n-m}^*\},$$

where x_n and y_n are jointly stationary random processes, $-\infty < n < \infty$, $-\infty < n < \infty$, and $E\{\cdot\}$ is the expected value operator.

Algorithms

`cpsd` uses Welch's averaged, modified periodogram method of spectral estimation.

References

- [1] Rabiner, Lawrence R., and B. Gold. *Theory and Application of Digital Signal Processing*. Englewood Cliffs, NJ: Prentice-Hall, 1975, pp.414–419.

- [2] Welch, Peter D. “The Use of the Fast Fourier Transform for the Estimation of Power Spectra: A Method Based on Time Averaging Over Short, Modified Periodograms.” *IEEE Transactions on Audio and Electroacoustics*, Vol. AU-15, June 1967, pp.70–73.
- [3] Oppenheim, Alan V., Ronald W. Schaffer, and John R. Buck. *Discrete-Time Signal Processing*. 2nd Ed. Upper Saddle River, NJ: Prentice Hall, 1999.

See Also

See Also

mscohere | pburg | pcov | peig | periodogram | pmcov | pmtm | pmusic | pwelch
| pyulear | tfestimate

Topics

“Cross Spectrum and Magnitude-Squared Coherence”

Introduced before R2006a

cusum

Detect small changes in mean using cumulative sum

Syntax

```
[iupper, ilower] = cusum(x)
```

```
[iupper, ilower] = cusum(x, climit, mshift, tmean, tdev)
```

```
[iupper, ilower] = cusum( ____, 'all' )
```

```
[iupper, ilower, uppersum, lowersum] = cusum( ____ )
```

```
cusum( ____ )
```

Description

`[iupper, ilower] = cusum(x)` returns the first index of the upper and lower cumulative sums of `x` that have drifted beyond five standard deviations above and below a target mean. The minimum detectable mean shift is set to one standard deviation. The target mean and standard deviations are estimated from the first 25 samples of `x`.

`[iupper, ilower] = cusum(x, climit, mshift, tmean, tdev)` specifies `climit`, the number of standard deviations that the upper and lower cumulative sums are allowed to drift from the mean. It also specifies the minimum detectable mean shift, the target mean, and the target standard deviation.

`[iupper, ilower] = cusum(____, 'all')` returns all the indices at which the upper and lower cumulative sums exceed the control limit.

`[iupper, ilower, uppersum, lowersum] = cusum(____)` also returns the upper and lower cumulative sums.

`cusum(____)` with no output arguments plots the upper and lower cumulative sums normalized to one standard deviation above and below the target mean.

Examples

cusum Default Values

Generate and plot a 100-sample random signal with a linear trend. Reset the random number generator for reproducible results.

```
rng('default')  
  
rnds = rand(1,100);  
trnd = linspace(0,1,100);  
  
fnc = rnds + trnd;  
  
plot(fnc)
```

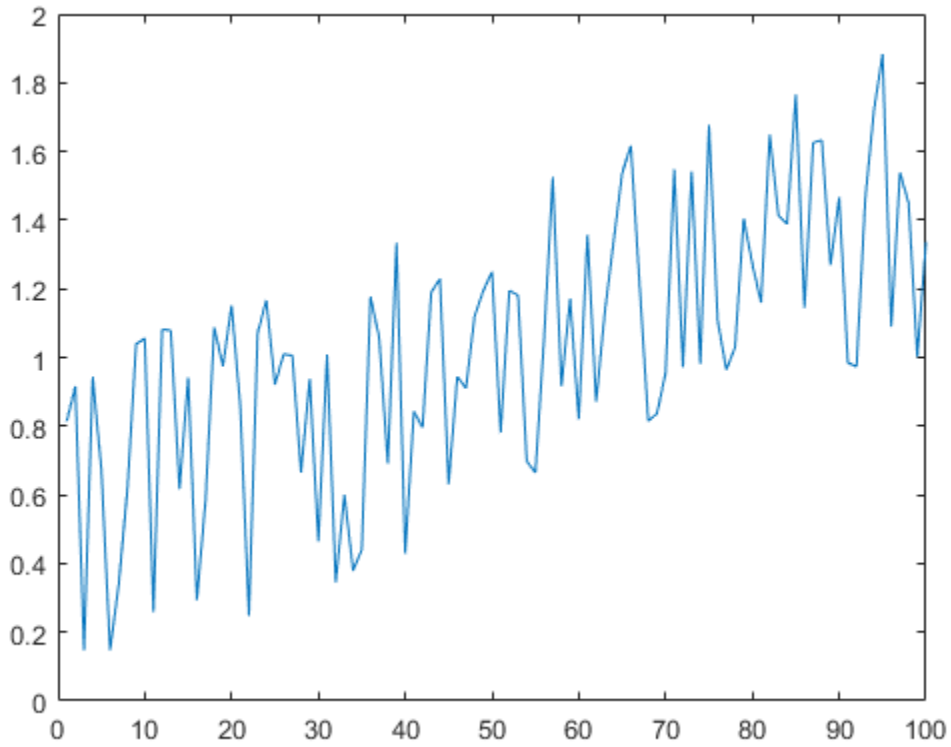

Apply `cusum` to the function using the default values of the input arguments.

```
cusum(fnc)
```

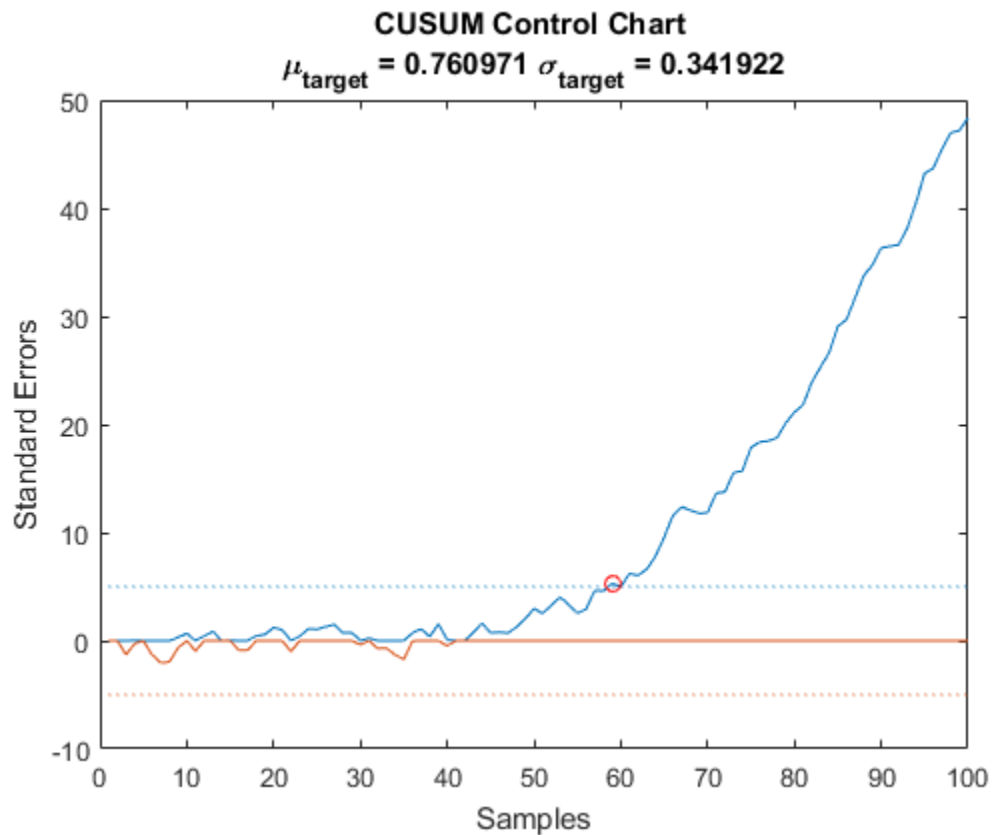

Compute the mean and standard deviation of the first 25 samples. Apply `cusum` using these numbers as the target mean and the target standard deviation. Highlight the point where the cumulative sum drifts more than five standard deviations beyond the target mean. Set the minimum detectable mean shift to one standard deviation.

```
mfnc = mean(fnc(1:25));
sfnc = std(fnc(1:25));

cusum(fnc,5,1,mfnc,sfnc)
```

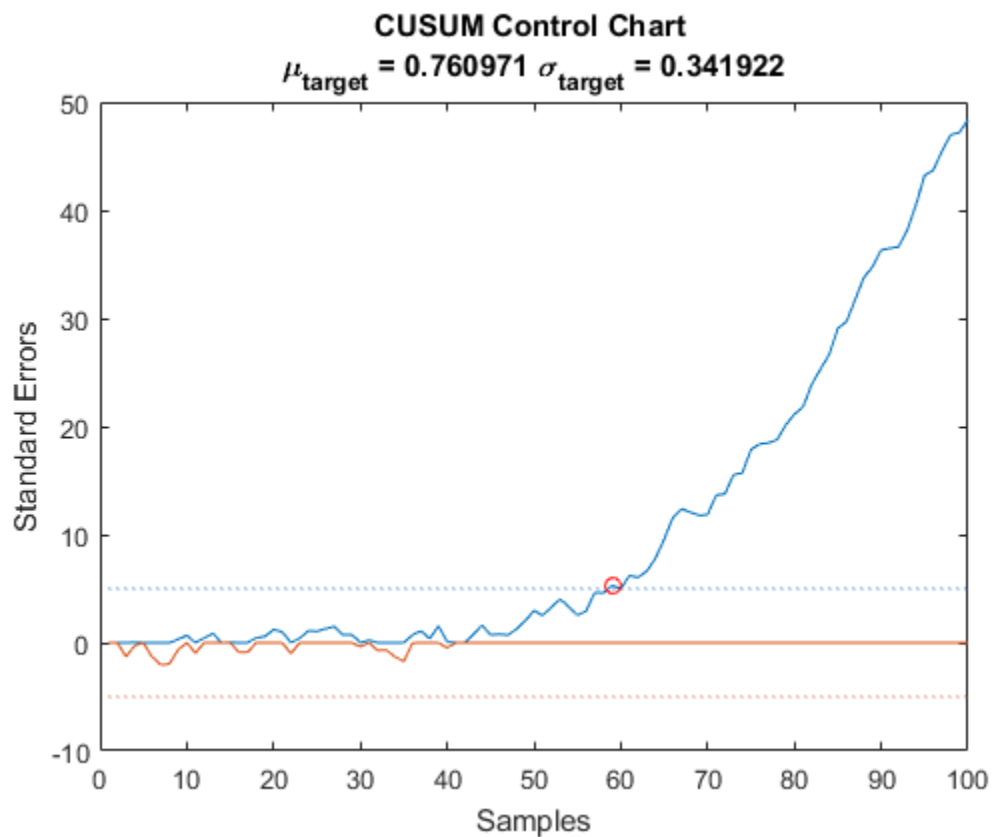

Repeat the calculation using a negative linear trend.

```
nnc = rnds - trnd;
```

```
cusum(nnc)
```

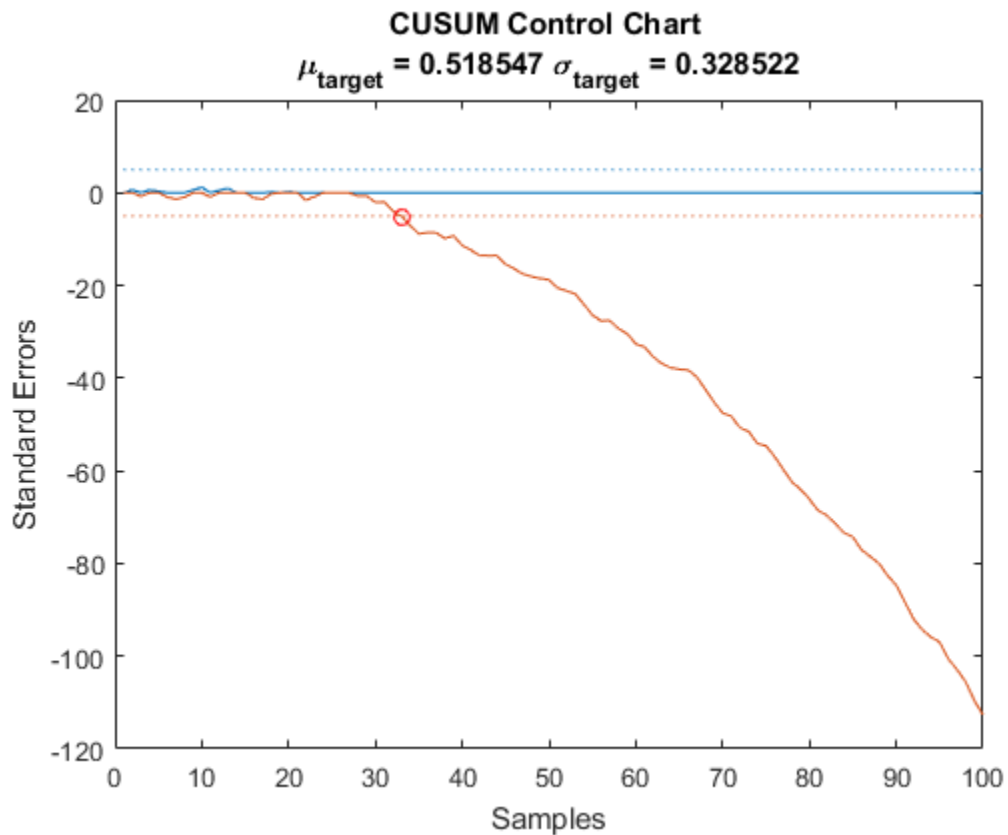

Unstable Motion Detection

Generate a signal resembling motion about an axle that becomes unstable due to wear. Add white Gaussian noise of variance 1/9. Reset the random number generator for reproducible results.

```
rng default
```

```
sz = 200;
```

```
dr = airy(2,linspace(-14.9371,1.2,sz));  
rd = dr + sin(2*pi*(1:sz)/5) + randn(1,sz)/3;
```

Plot the growing background drift and the resulting signal.

```
plot(dr)
hold on
plot(rd, '-.')
hold off
```

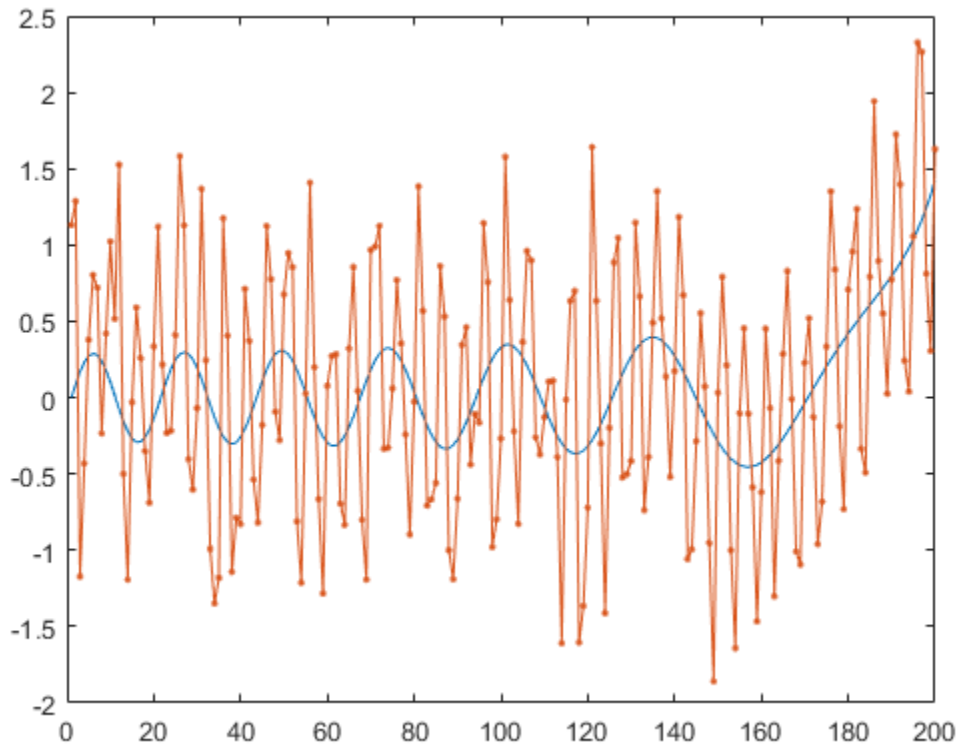

Find the mean and standard deviation if the drift is not present and there is no noise. Plot the ideal noiseless signal and its stable background.

```
id = 0.3*sin(2*pi*(1:sz)/20);
st = id + sin(2*pi*(1:sz)/5);

mf = mean(st)
sf = std(st)
```

```
plot(id)
hold on
plot(st, '-.')
hold off
```

```
mf =
```

```
-3.6463e-16
```

```
sf =
```

```
0.7401
```

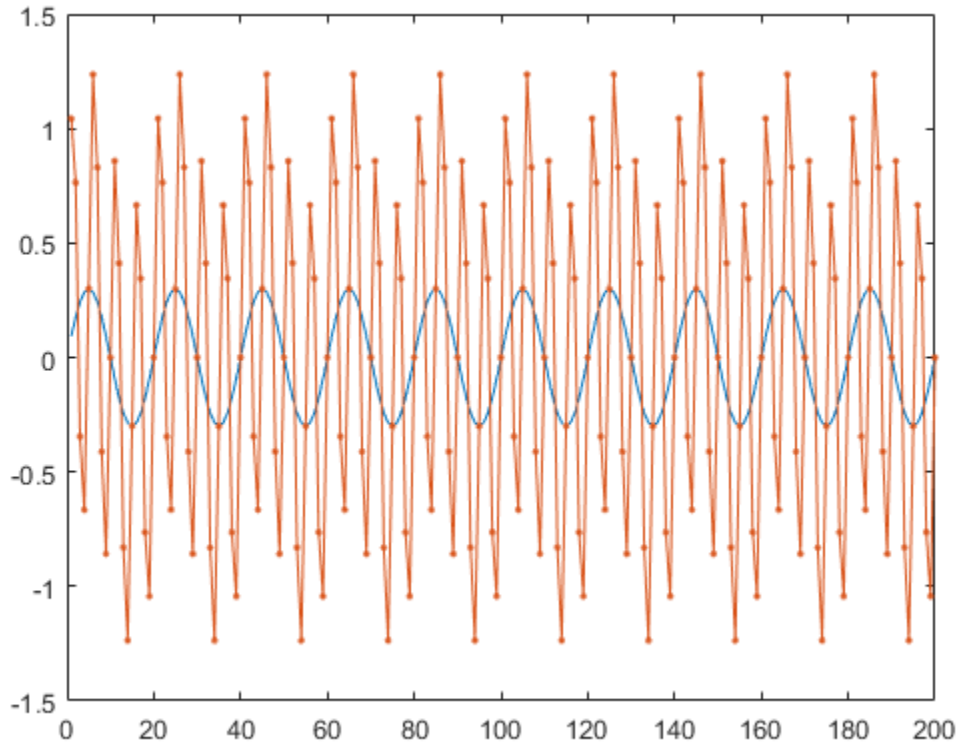

Use the CUSUM control chart to pinpoint the onset of instability. Assume that the system becomes unstable when the signal is three standard deviations beyond its ideal behavior. Specify a minimum detectable shift of one standard deviation.

```
cusum(rd,3,1,mf,sf)
```

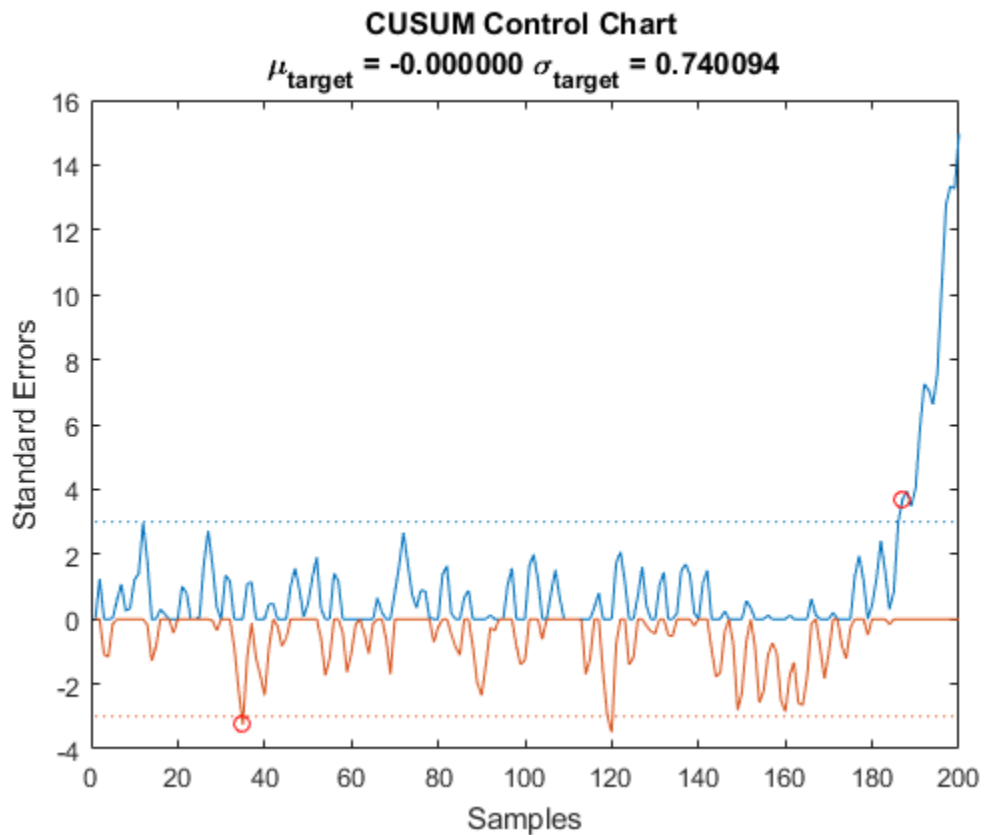
Make the violation criterion more strict by increasing the minimum detectable shift.
Return all instances of unwanted drift.

```
cusum(rd,3,1.2,mf,sf,'all')
```

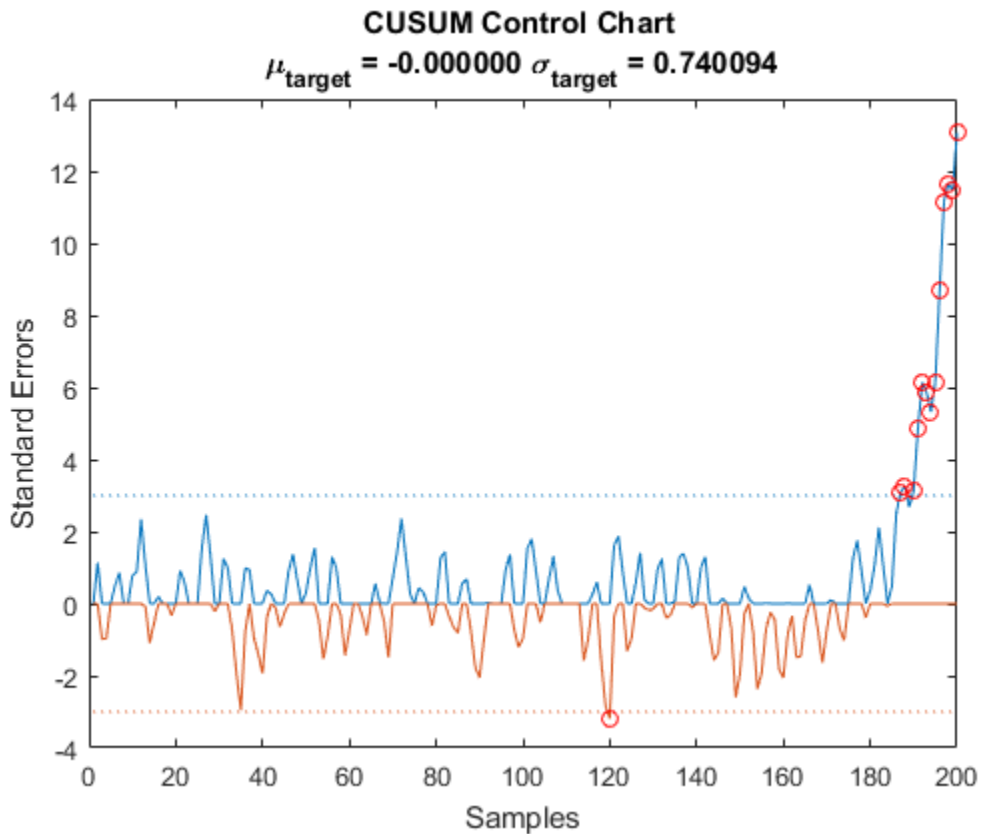

Golf Scorecards

Every hole in golf has an associated "par" that indicates the expected number of strokes needed to sink the ball. Skilled players usually complete each hole with a number of strokes very close to par. It is necessary to play several holes and let scores accumulate before a clear winner emerges in a match.

Ben, Jen, and Ken play a full round, which consists of 18 holes. The course has an assortment of par-3, par-4, and par-5 holes. At the end of the game, the players tabulate their scores.

```
hole = 1:18;
par = [4 3 5 3 4 5 3 4 4 4 5 3 5 4 4 4 3 4];
```

```
nms = {'Ben'; 'Jen'; 'Ken'};

Ben = [4 3 4 2 3 5 2 3 3 4 3 2 3 3 3 2 3];
Jen = [4 3 4 3 4 4 3 4 4 4 5 3 4 4 5 5 3 3];
Ken = [4 3 4 3 5 5 4 4 4 4 5 3 5 4 5 4 3 5];
```

```
T = table(hole', 'par', Ben', Jen', Ken', ...
          'VariableNames', ['hole'; 'par'; nms])
```

```
T = 18x5 table
   hole   par   Ben   Jen   Ken
   ----   ---   ---   ---   ---
     1     4     4     4     4
     2     3     3     3     3
     3     5     4     4     4
     4     3     2     3     3
     5     4     3     4     5
     6     5     5     4     5
     7     3     2     3     4
     8     4     3     4     4
     9     4     3     4     4
    10     4     4     4     4
    11     5     3     5     5
    12     3     2     3     3
    13     5     3     4     5
    14     4     3     4     4
    15     4     3     5     5
    16     4     3     5     4
    17     3     2     3     3
    18     4     3     3     5
```

The player whose lower cumulative sum drifts the most below par at the end of the round wins. Compute the sums for the three players to determine the winner. Make every shift in mean detectable by setting a small threshold.

```
[~,b,~,Bensum] = cusum(Ben-par,1,1e-4,0);
[~,j,~,Jensum] = cusum(Jen-par,1,1e-4,0);
[~,k,~,Kensum] = cusum(Ken-par,1,1e-4,0);

plot([Bensum;Jensum;Kensum]')
legend(nms, 'Location', 'best')
```

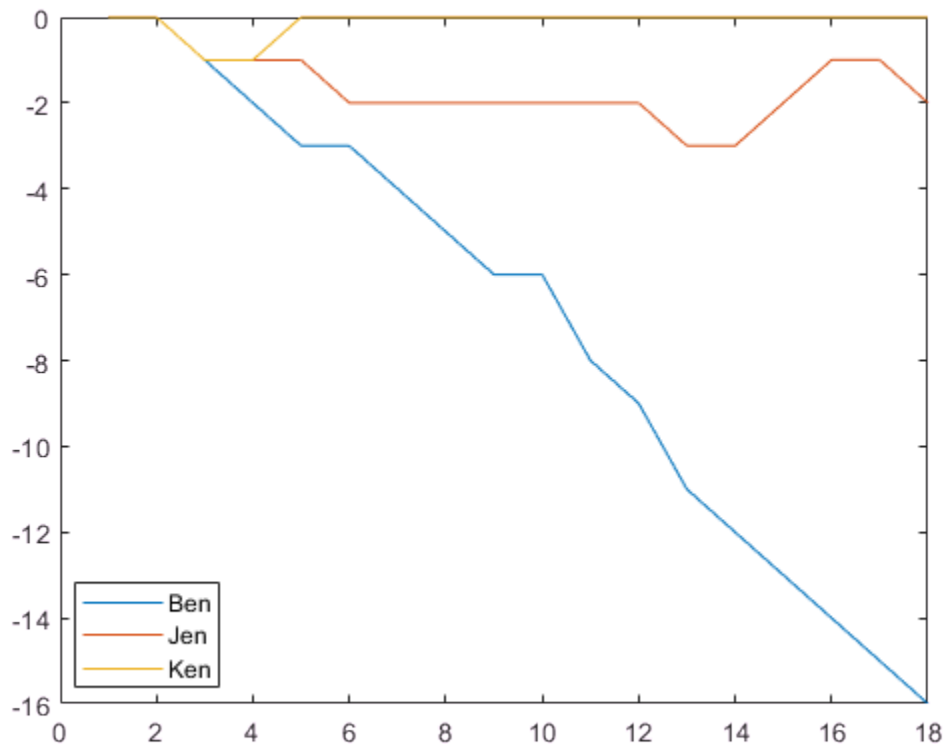

Ben wins the round. Simulate their next game by adding or subtracting a stroke per hole at random.

```
Ben = Ben+randi(3,1,18)-2;
Jen = Jen+randi(3,1,18)-2;
Ken = Ken+randi(3,1,18)-2;

[~,b,~,Bensum] = cusum(Ben-par,1,1e-4,0);
[~,j,~,Jensum] = cusum(Jen-par,1,1e-4,0);
[~,k,~,Kensum] = cusum(Ken-par,1,1e-4,0);

plot([Bensum;Jensum;Kensum]')
legend(nms, 'Location', 'best')
```

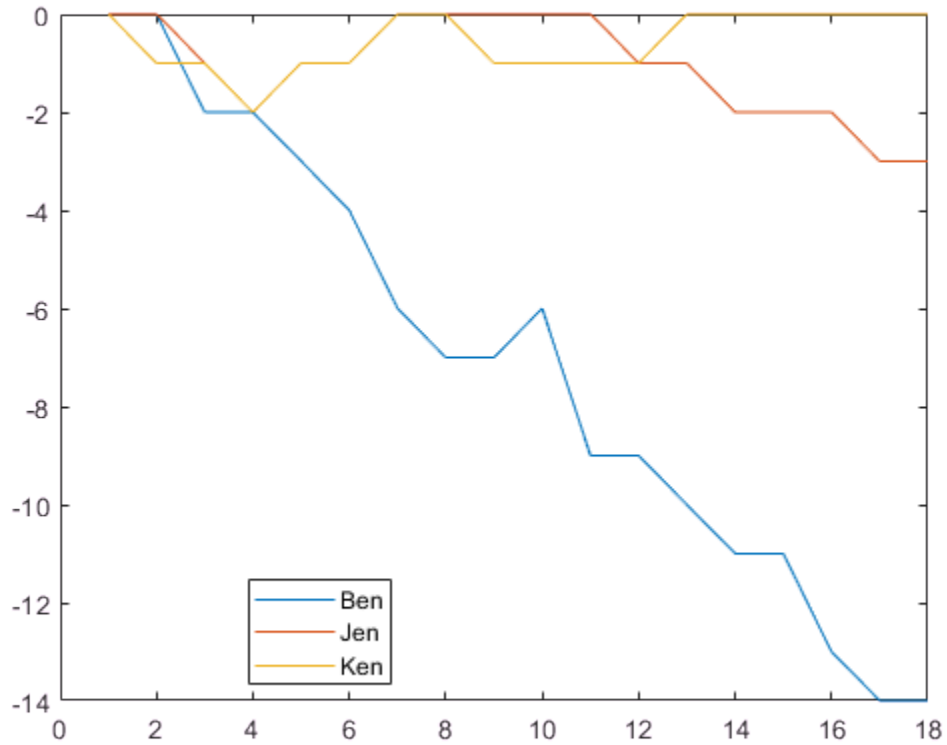

Input Arguments

x — Input signal

vector

Input signal, specified as a vector.

Example: `reshape(rand(100,1)*[-1 1],1,200)`

Data Types: `single` | `double`

climit — Control limit

5 (default) | real scalar

Control limit, specified as a real scalar expressed in standard deviations.

Data Types: `single` | `double`

mshift — Minimum mean shift to detect

1 (default) | real scalar

Minimum mean shift to detect, specified as a real scalar expressed in standard deviations.

Data Types: `single` | `double`

tmean — Target mean`sum(x(1:25))` (default) | real scalar

Target mean, specified as a real scalar. If `tmean` is not specified, then it is estimated as the mean of the first 25 samples of `x`.

Data Types: `single` | `double`

tdev — Target standard deviation`std(x(1:25))` (default) | real scalar

Target standard deviation, specified as a real scalar. If `tdev` is not specified, then it is estimated as the standard deviation of the first 25 samples of `x`.

Data Types: `single` | `double`

Output Arguments

iupper, ilower — Out-of-control point indices

integer scalars | integer vectors

Out-of-control point indices, returned as integer scalars or vectors. If all signal samples are within the specified tolerance, then `cusum` returns empty `iupper` and `ilower` arguments.

uppersum, lowersum — Upper and lower cumulative sums

vectors

Upper and lower cumulative sums, returned as vectors.

Definitions

CUSUM Control Chart

The CUSUM control chart is designed to detect small incremental changes in the mean of a process.

Given a sequence $x_1, x_2, x_3, \dots, x_n$ with estimated average m_x and estimated standard deviation σ_x , define upper and lower cumulative process sums using:

- Upper cumulative sum

$$U_i = \begin{cases} 0, & i = 1 \\ \max(0, U_{i-1} + x_i - m_x - \frac{1}{2}n\sigma_x), & i > 1 \end{cases}$$

- Lower sum

$$L_i = \begin{cases} 0, & i = 1 \\ \min(0, L_{i-1} + x_i - m_x + \frac{1}{2}n\sigma_x), & i > 1 \end{cases}$$

The variable n , represented in `cusum` by the `tmean` argument, is the number of standard deviations from the target mean that make a shift detectable.

A process violates the CUSUM criterion at the sample x_j if it obeys $U_j > c\sigma_x$ or $L_j < -c\sigma_x$. The control limit c is represented in `cusum` by the `climit` argument.

By default, the function returns the first violation it detects. If you specify the `'all'` flag, the function returns every violation.

See Also

See Also

`findchangepts` | `mean`

Introduced in R2016a

czt

Chirp Z-transform

Syntax

```
y = czt(x,m,w,a)
y = czt(x)
```

Description

`y = czt(x,m,w,a)` returns the chirp Z-transform of signal `x`. The chirp Z-transform is the Z-transform of `x` along a spiral contour defined by `w` and `a`. `m` is a scalar that specifies the length of the transform, `w` is the ratio between points along the z -plane spiral contour of interest, and scalar `a` is the complex starting point on that contour. The contour, a spiral or “chirp” in the z -plane, is given by

$$z = a \cdot (w.^-(0:m-1))$$

`y = czt(x)` uses the following default values:

- `m = length(x)`
- `w = exp(-j*2*pi/m)`
- `a = 1`

With these defaults, `czt` returns the Z-transform of `x` at `m` equally spaced points around the unit circle. This is equivalent to the discrete Fourier transform of `x`, or `fft(x)`. The empty matrix `[]` specifies the default value for a parameter.

If `x` is a matrix, `czt(x,m,w,a)` transforms the columns of `x`.

Examples

CZT of a Random Vector

Create a random vector, `x`, of length 1013. Compute its DFT using `czt`.

```
rng default
```

```
x = randn(1013,1);  
y = czt(x);
```

Narrow-Band Section of a Frequency Response

Use `czt` to zoom in on a narrow-band section of a filter's frequency response.

Design a 30th-order lowpass FIR filter using the window method. Specify a sample rate of 1 kHz and a cutoff frequency of 125 Hz. Use a rectangular window. Find the transfer function of the filter.

```
fs = 1000;  
d = designfilt('lowpassfir','FilterOrder',30,'CutoffFrequency',125, ...  
    'DesignMethod','window','Window',@rectwin,'SampleRate',fs);  
h = tf(d);
```

Compute the DFT and the CZT of the filter. Restrict the frequency range of the CZT to the band between 100 and 150 Hz. Generate 1024 samples in each case.

```
m = 1024;  
y = fft(h,m);  
  
f1 = 100;  
f2 = 150;  
w = exp(-j*2*pi*(f2-f1)/(m*fs));  
a = exp(j*2*pi*f1/fs);  
z = czt(h,m,w,a);
```

Plot the transforms. Zoom in on the area of interest.

```
fn = (0:m-1)'/m;  
fy = fs*fn;  
fz = (f2-f1)*fn + f1;  
  
subplot(2,1,1)  
plot(fy,abs(y))  
axis([f1 f2 0 1.2])  
title('FFT')  
  
subplot(2,1,2)  
plot(fz,abs(z))  
axis([f1 f2 0 1.2])  
title('CZT')  
xlabel('Frequency (Hz)')
```

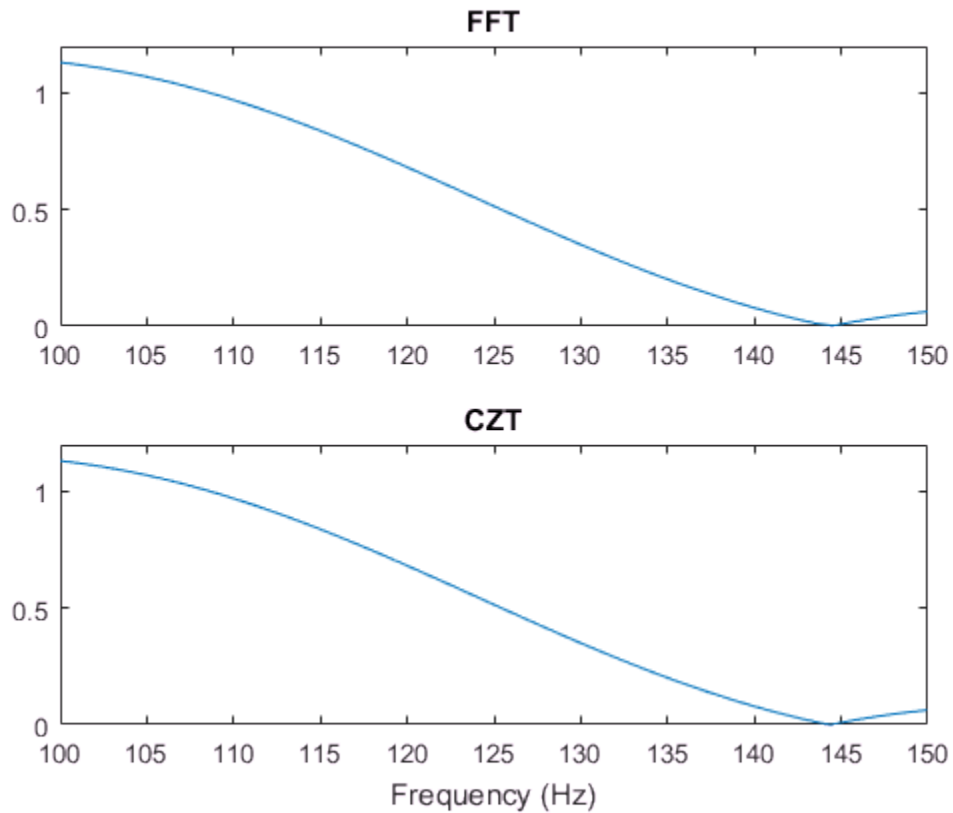

Diagnostics

If m , w , or a is not a scalar, `czt` gives the following error message:

Inputs M , W , and A must be scalars.

Algorithms

`czt` uses the next power-of-2 length FFT to perform a fast convolution when computing the z -transform on a specified chirp contour [1].

References

- [1] Rabiner, Lawrence R., and Bernard Gold. *Theory and Application of Digital Signal Processing*. Englewood Cliffs, NJ: Prentice-Hall, 1975, pp.393–399.

See Also

fft | freqz

Introduced before R2006a

db

Convert energy or power measurements to decibels

Syntax

```
dboutput = db(x)
dboutput = db(x,SignalType)
dboutput = db(x,R)
dboutput = db(x,'voltage',R)
```

Description

`dboutput = db(x)` converts the elements of `x` to decibels (dB). This syntax assumes that `x` contains voltage measurements across a resistance of 1Ω .

`dboutput = db(x,SignalType)` specifies the signal type represented by the elements of `x` as either `'voltage'` or `'power'`.

`dboutput = db(x,R)` specifies the resistance, `R`, for voltage measurements.

`dboutput = db(x,'voltage',R)` is equivalent to `db(x,R)`.

Examples

Decibels from Voltage and Power

Express a unit voltage in decibels. Assume that the resistance is 2 ohms. Compare the

answer to the definition, $10 \log_{10} \frac{1}{2}$.

```
V = 1;
R = 2;
dboutput = db(V,2);
compvoltage = [dboutput 10*log10(1/2)]
compvoltage =
```

```
-3.0103 -3.0103
```

Convert a vector of power measurements to decibels. Compare the answer to the result of using the definition.

```
rng default
X = abs(rand(10,1));
dboutput = db(X,'power');
comppower = [dboutput 10*log10(X)]
```

```
comppower =
```

```
-0.8899 -0.8899
-0.4297 -0.4297
-8.9624 -8.9624
-0.3935 -0.3935
-1.9904 -1.9904
-10.1082 -10.1082
-5.5518 -5.5518
-2.6211 -2.6211
-0.1886 -0.1886
-0.1552 -0.1552
```

Input Arguments

x — Signal measurements

scalar | vector | matrix | N-D array

Signal measurements, specified as a scalar, vector, matrix, or N-D array.

Data Types: `single` | `double`

Complex Number Support: Yes

SignalType — Type of signal measurements

'voltage' (default) | 'power'

Type of signal measurements, specified as either 'voltage' or 'power'. If you specify `SignalType` as 'power', then all elements of `x` must be nonnegative.

Data Types: `char`

R — Resistive load

1 Ω (default) | positive scalar

Resistive load, specified as a positive scalar expressed in ohms. This argument is ignored if you specify `SignalType` as 'power'.

Data Types: single | double

Output Arguments

dboutput — Energy or power measurements in decibels

scalar | vector | matrix | N-D array

Energy or power measurements in decibels, returned as an array with the same dimensions as `x`.

- If `x` contains voltage measurements, then `dboutput` is $10 \log_{10}(|x|^2/R)$.
- If the input `x` contains power measurements, then `dboutput` is $10 \log_{10} x$.

See Also

See Also

db2mag | db2pow | mag2db | pow2db

Introduced in R2011b

db2mag

Convert decibels to magnitude

Syntax

```
y = db2mag(ydb)
```

Description

`y = db2mag(ydb)` returns the magnitude measurements, `y`, that correspond to the decibel (dB) values specified in `ydb`. The relationship between magnitude and decibels is $ydb = 20 \log_{10}(y)$.

Examples

Magnitudes of Random Numbers

Generate a 2-by-4-by-2 array of Gaussian random numbers. Assume the numbers are expressed in decibels and compute the corresponding magnitudes.

```
r = randn(2,4,2);
```

```
mags = db2mag(r)
```

```
mags =
```

```
(:,:,1) =
```

1.0639	0.7710	1.0374	0.9513
1.2351	1.1044	0.8602	1.0402

```
(:,:,2) =
```

1.5098	0.8561	1.0871	1.0858
1.3755	1.4182	0.9928	0.9767

Use the definition to check the calculation.

```
chck = 10.^(r/20)
chck =
(:, :, 1) =
    1.0639    0.7710    1.0374    0.9513
    1.2351    1.1044    0.8602    1.0402

(:, :, 2) =
    1.5098    0.8561    1.0871    1.0858
    1.3755    1.4182    0.9928    0.9767
```

Input Arguments

ydb — Input array in decibels

scalar | vector | matrix | N-D array

Input array in decibels, specified as a scalar, vector, matrix, or N-D array. When ydb is nonscalar, `db2mag` is an element-wise operation.

Data Types: `single` | `double`

Output Arguments

y — Magnitude measurements

scalar | vector | matrix | N-D array

Magnitude measurements, returned as a scalar, vector, matrix, or N-D array of the same size as ydb.

See Also

See Also

`db` | `db2pow` | `mag2db` | `pow2db`

Introduced in R2008a

db2pow

Convert decibels to power

Syntax

```
y = db2pow(ydb)
```

Description

`y = db2pow(ydb)` returns the power measurements, `y`, that correspond to the decibel (dB) values specified in `ydb`. The relationship between power and decibels is $ydb = 10 \log_{10}(y)$.

Examples

Power Values of Random Numbers

Generate a 2-by-4-by-2 array of Gaussian random numbers. Assume the numbers are expressed in decibels and compute the corresponding power measurements.

```
r = randn(2,4,2);
```

```
pows = db2pow(r)
```

```
pows =
```

```
(:,:,1) =
```

1.1318	0.5944	1.0762	0.9050
1.5254	1.2196	0.7400	1.0821

```
(:,:,2) =
```

2.2795	0.7328	1.1818	1.1789
--------	--------	--------	--------

```
1.8921    2.0114    0.9856    0.9539
```

Use the definition to check the calculation.

```
chck = 10.^(r/10)
```

```
chck =
```

```
(:,: ,1) =
```

```
1.1318    0.5944    1.0762    0.9050  
1.5254    1.2196    0.7400    1.0821
```

```
(:,: ,2) =
```

```
2.2795    0.7328    1.1818    1.1789  
1.8921    2.0114    0.9856    0.9539
```

Input Arguments

ydb — Input array in decibels

scalar | vector | matrix | N-D array

Input array in decibels, specified as a scalar, vector, matrix, or N-D array. When **ydb** is nonscalar, **db2pow** is an element-wise operation.

Data Types: `single` | `double`

Output Arguments

y — Power measurements

scalar | vector | matrix | N-D array

Power measurements, returned as a scalar, vector, matrix, or N-D array of the same size as **ydb**.

Extended Capabilities

C/C++ Code Generation

Generate C and C++ code using MATLAB® Coder™.

See Also

See Also

db | db2mag | mag2db | pow2db

Introduced in R2007b

dct

Discrete cosine transform

Syntax

```
y = dct(x)
y = dct(x,n)

y = dct(x,n,dim)

y = dct( ____, 'Type', dcttype)
```

Description

`y = dct(x)` returns the unitary discrete cosine transform of input array `x`. The output `y` has the same size as `x`. If `x` has more than one dimension, then `dct` operates along the first array dimension with size greater than 1.

`y = dct(x,n)` zero-pads or truncates the relevant dimension of `x` to length `n` before transforming.

`y = dct(x,n,dim)` computes the transform along dimension `dim`. To input a dimension and use the default value of `n`, specify the second argument as empty, `[]`.

`y = dct(____, 'Type', dcttype)` specifies the type of discrete cosine transform to compute. See “Discrete Cosine Transform” on page 1-257 for details. This option can be combined with any of the previous syntaxes.

Examples

Energy Stored in DCT Coefficients

Find how many DCT coefficients represent 99% of the energy in a sequence.

```
x = (1:100) + 50*cos((1:100)*2*pi/40);
X = dct(x);
[XX,ind] = sort(abs(X), 'descend');
```

```
i = 1;
while norm(X(ind(1:i)))/norm(X) < 0.99
    i = i + 1;
end
needed = i;
```

Reconstruct the signal and compare it to the original signal.

```
X(ind(needed+1:end)) = 0;
xx = idct(X);
```

```
plot([x;xx]')
legend('Original', ['Reconstructed, N = ' int2str(needed)], ...
      'Location', 'SouthEast')
```

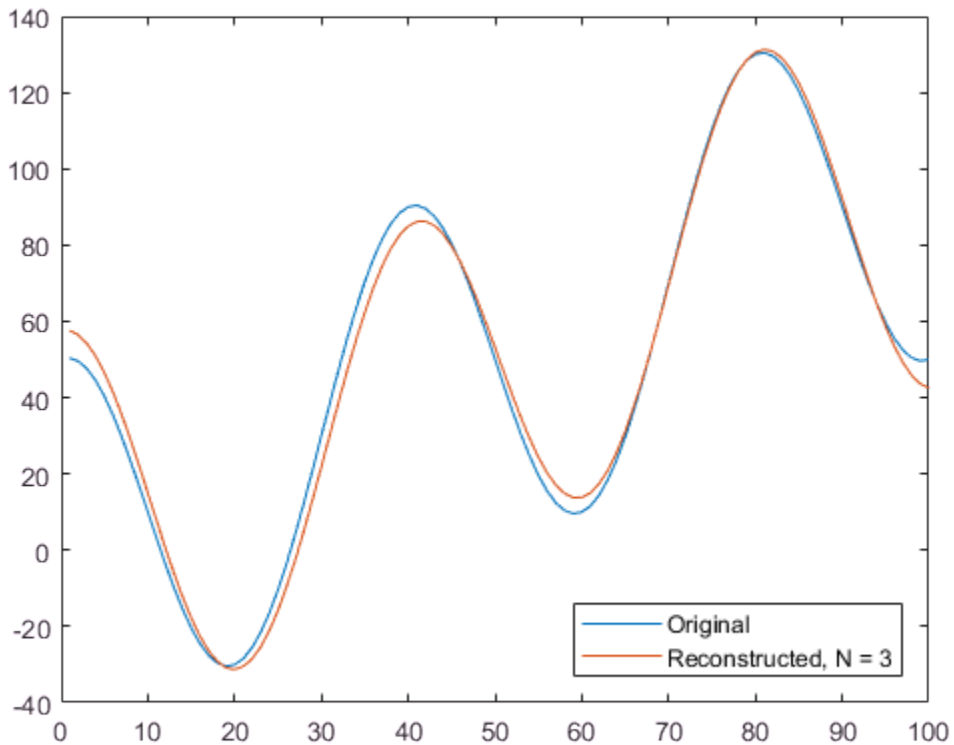

Image Data Compression

Load a file that contains depth measurements of a mold used to mint a United States penny. The data, taken at the National Institute of Standards and Technology, are sampled on a 128-by-128 grid. Display the data.

```
load penny  
  
surf(P)  
view(2)  
colormap copper  
shading interp  
axis ij square off
```



Compute the discrete cosine transform of the image data. Operate first along the rows and then along the columns.

```
Q = dct(P,[],1);
R = dct(Q,[],2);
```

Find what percentage of DCT coefficients contain 99.9% of the energy in the image.

```
X = R(:);

[~,ind] = sort(abs(R(:)), 'descend');
coeffs = 1;
while norm(X(ind(1:coeffs)))/norm(X) < 0.999
    coeffs = coeffs + 1;
end
fprintf('%3.1f%% of the coefficients are sufficient\n',coeffs/numel(R)*100)
```

```
6.9% of the coefficients are sufficient
```

Reconstruct the image using only the necessary coefficients.

```
R(abs(R) < X(coeffs)) = 0;

S = idct(R,[],2);
T = idct(S,[],1);
```

Display the reconstructed image.

```
surf(T)
view(2)
shading interp
axis ij square off
```



Image Resizing

Load a file that contains depth measurements of a mold used to mint a United States penny. The data, taken at the National Institute of Standards and Technology, are sampled on a 128-by-128 grid. Display the data.

```
load penny  
  
surf(P)  
view(2)  
colormap copper  
shading interp  
axis ij square off
```



Compute the discrete cosine transform of the image data using the DCT-1 variant. Operate first along the rows and then along the columns.

```
Q = dct(P,[],1,'Type',1);  
R = dct(Q,[],2,'Type',1);
```

Invert the transform. Truncate the inverse so that each dimension of the reconstructed image is one-half the length of the original.

```
S = idct(R,size(P,2)/2,2,'Type',1);  
T = idct(S,size(P,1)/2,1,'Type',1);
```

Invert the transform again. Zero-pad the inverse so that each dimension of the reconstructed image is twice the length of the original.

```
U = idct(R,size(P,2)*2,2,'Type',1);  
V = idct(U,size(P,1)*2,1,'Type',1);
```

Display the original and reconstructed images.

```
surf(V)  
view(2)  
shading interp  
hold on  
  
surf(P)  
view(2)  
shading interp  
  
surf(T)  
view(2)  
shading interp  
hold off  
axis ij equal off
```

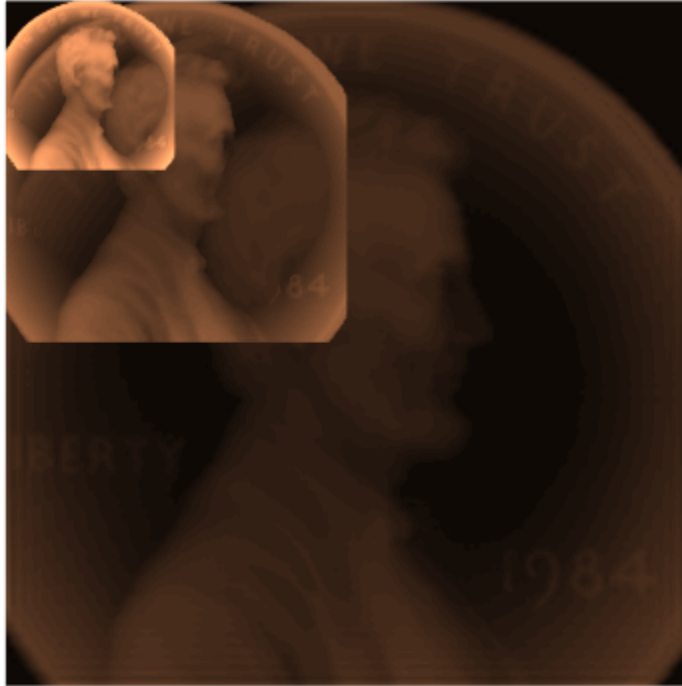

- “DCT for Speech Signal Compression”

Input Arguments

x — Input array

vector | matrix | N-D array | gpuArray object

Input array, specified as a real-valued or complex-valued vector, matrix, N-D array, or gpuArray object.

See “GPU Computing” (Parallel Computing Toolbox) and GPU System Requirements for details on gpuArray objects.

Example: `sin(2*pi*(0:255)/4)` specifies a sinusoid as a row vector.

Example: `sin(2*pi*[0.1;0.3]*(0:39))'` specifies a two-channel sinusoid.

Data Types: `single` | `double`

Complex Number Support: Yes

n — Transform length

positive integer scalar

Transform length, specified as a positive integer scalar.

Data Types: `single` | `double`

dim — Dimension to operate along

positive integer scalar

Dimension to operate along, specified as a positive integer scalar.

Data Types: `single` | `double`

dcttype — Discrete cosine transform type

2 (default) | 1 | 3 | 4

Discrete cosine transform type, specified as a positive integer scalar from 1 to 4. See “Discrete Cosine Transform” on page 1-257 for the definitions of the different types of DCT.

Data Types: `single` | `double`

Output Arguments

y — Discrete cosine transform

vector | matrix | N-D array | `gpuArray` object

Discrete cosine transform, returned as a real-valued or complex-valued vector, matrix, N-D array, or `gpuArray` object.

Definitions

Discrete Cosine Transform

The discrete cosine transform (DCT) is closely related to the discrete Fourier transform. You can often reconstruct a sequence very accurately from only a few DCT coefficients. This property is useful for applications requiring data reduction.

The DCT has four standard variants. For a signal x of length N , and with δ_{kl} the Kronecker delta, the transforms are defined by:

- DCT-1:

$$y(k) = \sqrt{\frac{2}{N}} \sum_{n=1}^N x(n) \frac{1}{\sqrt{1 + \delta_{n1} + \delta_{nN}}} \frac{1}{\sqrt{1 + \delta_{k1} + \delta_{kN}}} \cos\left(\frac{\pi}{N-1}(n-1)(k-1)\right)$$

- DCT-2:

$$y(k) = \sqrt{\frac{2}{N}} \sum_{n=1}^N x(n) \frac{1}{\sqrt{1 + \delta_{k1}}} \cos\left(\frac{\pi}{2N}(2n-1)(k-1)\right)$$

- DCT-3:

$$y(k) = \sqrt{\frac{2}{N}} \sum_{n=1}^N x(n) \frac{1}{\sqrt{1 + \delta_{n1}}} \cos\left(\frac{\pi}{2N}(n-1)(2k-1)\right)$$

- DCT-4:

$$y(k) = \sqrt{\frac{2}{N}} \sum_{n=1}^N x(n) \cos\left(\frac{\pi}{4N}(2n-1)(2k-1)\right)$$

The series are indexed from $n = 1$ and $k = 1$ instead of the usual $n = 0$ and $k = 0$, because MATLAB vectors run from 1 to N instead of from 0 to $N - 1$.

All variants of the DCT are *unitary* (or, equivalently, *orthogonal*): To find their inverses, switch k and n in each definition. In particular, DCT-1 and DCT-4 are their own inverses, and DCT-2 and DCT-3 are inverses of each other.

References

- [1] Jain, A. K. *Fundamentals of Digital Image Processing*. Englewood Cliffs, NJ: Prentice-Hall, 1989.
- [2] Pennebaker, W. B., and J. L. Mitchell. *JPEG Still Image Data Compression Standard*. New York: Van Nostrand-Reinhold, 1993.
- [3] Oppenheim, Alan V., Ronald W. Schafer, and John R. Buck. *Discrete-Time Signal Processing*. 2nd Ed. Upper Saddle River, NJ: Prentice Hall, 1999.

Extended Capabilities

C/C++ Code Generation

Generate C and C++ code using MATLAB® Coder™.

Usage notes and limitations:

- C and C++ code generation for `dct` requires DSP System Toolbox™ software.
- The length of the transform dimension must be a power of two. If specified, the `pad` or `truncation` value must be constant. Expressions or variables are allowed if their values do not change.

See Also

See Also

`dct2` | `fft` | `idct` | `idct2`

Topics

“DCT for Speech Signal Compression”

Introduced before R2006a

decimate

Decimation — decrease sampling rate

Syntax

```
y = decimate(x,r)
y = decimate(x,r,n)
y = decimate(x,r,'fir')
y = decimate(x,r,n,'fir')
```

Description

Decimation reduces the original sampling rate of a sequence to a lower rate. It is the opposite of interpolation. **decimate** lowpass filters the input to guard against aliasing and downsamples the result.

`y = decimate(x,r)` reduces the sampling rate of `x`, the input signal, by a factor of `r`. The decimated vector, `y`, is shortened by a factor of `r` so that `length(y) = ceil(length(x)/r)`. By default, **decimate** uses a lowpass Chebyshev Type I IIR filter of order 8.

`y = decimate(x,r,n)` uses a Chebyshev filter of order `n`. Orders above 13 are not recommended because of numerical instability. The function displays a warning in those cases.

`y = decimate(x,r,'fir')` uses an FIR filter designed using the window method with a Hamming window. The filter has order 30.

`y = decimate(x,r,n,'fir')` uses an FIR filter of order `n`.

Note: For better results when `r` is greater than 13, divide `r` into smaller factors and call **decimate** several times.

Input Arguments

x — Input signal

vector

Input signal, specified as a vector.

Data Types: double

r — Decimation factor

positive integer scalar

Decimation factor, specified as a positive integer scalar.

Data Types: double

n — Filter order

positive integer scalar

Filter order, specified as a positive integer scalar. When using the IIR filter, avoid values above 13 because sometimes the results are unreliable.

Data Types: double

Output Arguments

y — Decimated signal

vector

Decimated signal, returned as a vector.

Data Types: double

Examples

Decimate a Signal

Create a sinusoidal signal sampled at 4 kHz. Decimate it by a factor of four.

```
t = 0:.00025:1;
```

```
x = sin(2*pi*30*t) + sin(2*pi*60*t);  
y = decimate(x,4);
```

Plot the original and decimated signals.

```
subplot 211  
stem(0:120,x(1:121),'filled','markersize',3)  
grid on  
xlabel 'Sample number',ylabel 'Original'  
subplot 212  
stem(0:30,y(1:31),'filled','markersize',3)  
grid on  
xlabel 'Sample number',ylabel 'Decimated'
```

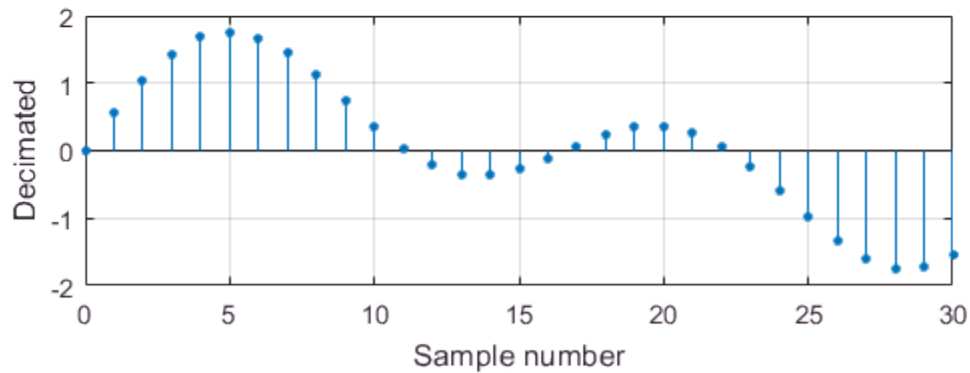
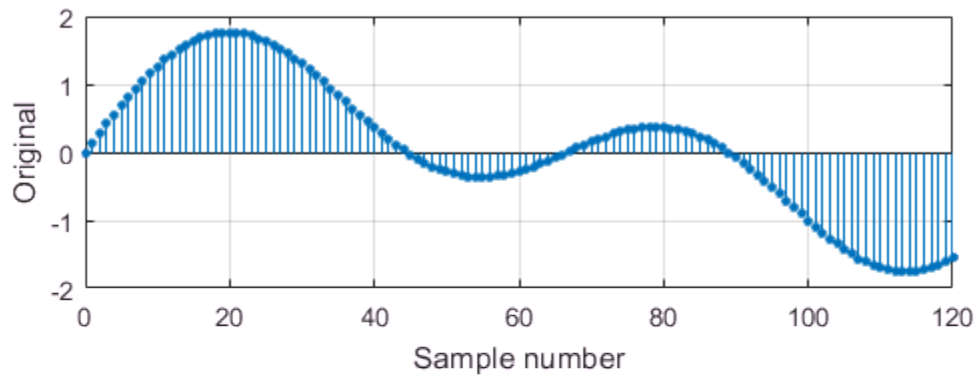

Decimate a Signal Using the Chebyshev Filter

Create a signal with two sinusoids. Decimate it by a factor of 13 using a Chebyshev IIR filter of order 5. Plot the original and decimated signals.

```
r = 13;
n = 16:365;
lx = length(n);
x = sin(2*pi*n/153) + cos(2*pi*n/127);

plot(0:lx-1,x,'o')
hold on
y = decimate(x,r,5);
stem(lx-1:-r:0,flipr(y),'ro','filled','markersize',4)

legend('Original','Decimated','Location','south')
xlabel('Sample number')
ylabel('Signal')
```

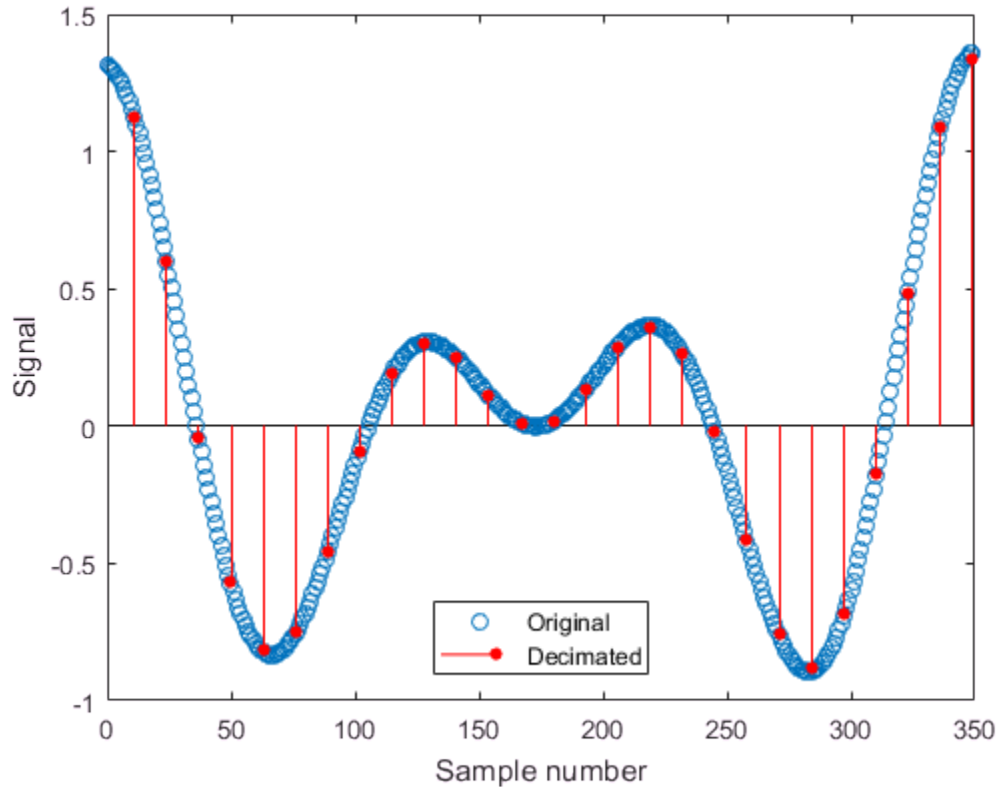

The original and decimated signals have matching *last* elements.

Decimate a Signal Using the FIR Filter

Create a signal with two sinusoids. Decimate it by a factor of 13 using an FIR filter of order 82. Plot the original and decimated signals.

```
r = 13;  
n = 16:365;  
lx = length(n);  
x = sin(2*pi*n/153) + cos(2*pi*n/127);  
  
plot(0:lx-1,x,'o')
```

```

hold on
y = decimate(x,r,82,'fir');
stem(0:r:lx-1,y,'ro','filled','markersize',4)

legend('Original','Decimated','Location','south')
xlabel('Sample number')
ylabel('Signal')

```

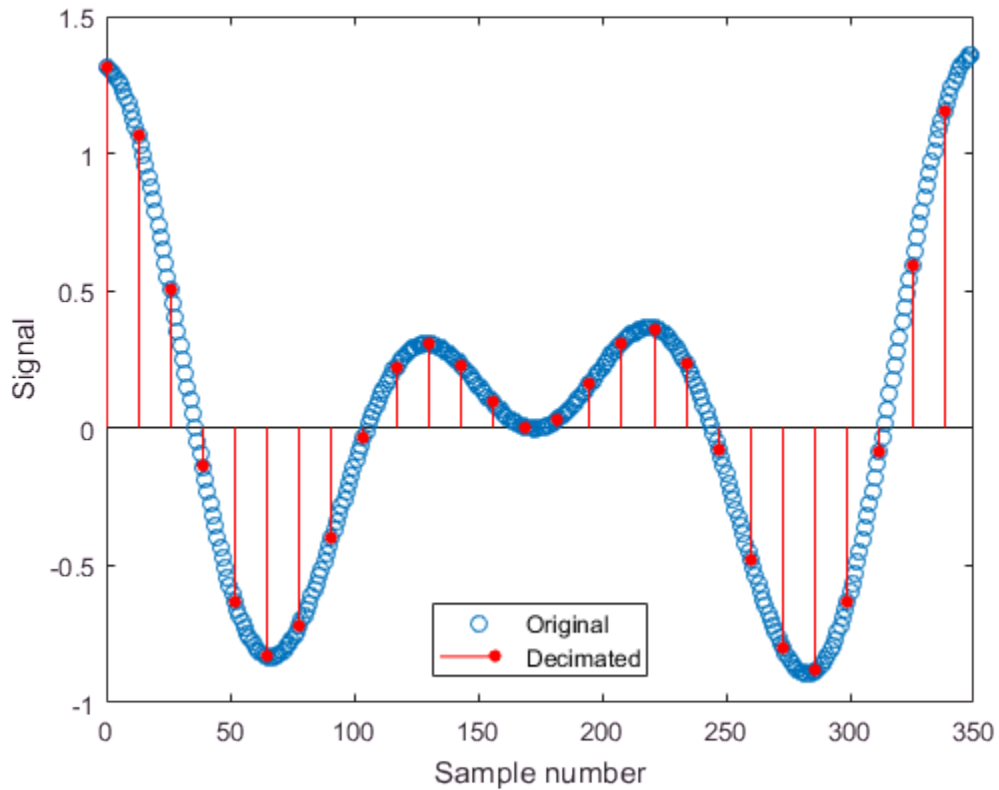

The original and decimated signals have matching *first* elements.

Algorithms

`decimate` uses decimation algorithms 8.2 and 8.3 from [1].

- 1 `decimate` creates a lowpass filter. The default is a Chebyshev Type I filter designed using `cheby1`. This filter has normalized cutoff frequency $0.8/r$ and passband ripple 0.05 dB. Sometimes, the specified filter order produces passband distortion due to roundoff errors accumulated from the convolutions needed to create the transfer function. The filter order is automatically reduced when distortion causes the magnitude response at the cutoff frequency to differ from the ripple by more than 10^{-6} .

When the `'fir'` option is chosen, `decimate` uses `fir1` to design a lowpass FIR filter with cutoff frequency $1/r$.

- 2 When using the FIR filter, `decimate` filters the input sequence in only one direction. This conserves memory and is useful for working with long sequences. In the IIR case, `decimate` applies the filter in forward and reverse directions using `filtfilt` to remove phase distortion. This in effect doubles the filter order. In both cases, the function minimizes transient effects at both ends of the signal by matching endpoint conditions.
- 3 Finally, `decimate` resamples the data by selecting every r th point from the interior of the filtered signal. The resampled sequence is such that `y(end)` matches `x(end)` when the IIR filter is used and `y(1)` matches `x(1)` in the FIR case.

References

- [1] Digital Signal Processing Committee of the IEEE Acoustics, Speech, and Signal Processing Society, eds. *Programs for Digital Signal Processing*. New York: IEEE Press, 1979, chap. 8.

See Also

`cheby1` | `downsample` | `filtfilt` | `fir1` | `interp` | `resample`

Introduced before R2006a

demod

Demodulation for communications simulation

Syntax

```
x = demod(y,fc,fs,'method')  
x = demod(y,fc,fs,'method',opt)  
x = demod(y,fc,fs,'pwm','centered')
```

Description

`demod` performs demodulation, that is, it obtains the original signal from a modulated version of the signal. `demod` undoes the operation performed by `modulate`.

`x = demod(y,fc,fs,'method')` and

`x = demod(y,fc,fs,'method',opt)` demodulate the real carrier signal `y` with a carrier frequency `fc` and sampling frequency `fs`, using one of the options listed below for `method`. (Note that some methods accept an option, `opt`.)

Note: Use `demod` and `modulate` in the Signal Processing Toolbox™ with real-valued signals to obtain real-valued outputs. `demod` and `modulate` are not intended to accept complex-valued inputs or produce complex-valued outputs.

Method	Description
<code>amdsb-sc</code> or <code>am</code>	Amplitude demodulation, double sideband, suppressed carrier. Multiplies <code>y</code> by a sinusoid of frequency <code>fc</code> and applies a fifth-order Butterworth lowpass filter using <code>filtfilt</code> . <pre>x = y.*cos(2*pi*fc*t); [b,a] = butter(5,fc*2/fs); x = filtfilt(b,a,x);</pre>

Method	Description
amdsb-tc	<p>Amplitude demodulation, double sideband, transmitted carrier. Multiplies y by a sinusoid of frequency fc and applies a fifth-order Butterworth lowpass filter using <code>filtfilt</code>.</p> <pre>x = y.*cos(2*pi*fc*t); [b,a] = butter(5,fc*2/fs); x = filtfilt(b,a,x);</pre> <p>If you specify <code>opt</code>, <code>demod</code> subtracts scalar <code>opt</code> from x. The default value for <code>opt</code> is 0.</p>
amssb	<p>Amplitude demodulation, single sideband. Multiplies y by a sinusoid of frequency fc and applies a fifth-order Butterworth lowpass filter using <code>filtfilt</code>.</p> <pre>x = y.*cos(2*pi*fc*t); [b,a] = butter(5,fc*2/fs); x = filtfilt(b,a,x);</pre>
fm	<p>Frequency demodulation. Demodulates the FM waveform by modulating the Hilbert transform of y by a complex exponential of frequency $-fc$ Hz and obtains the instantaneous frequency of the result.</p>
pm	<p>Phase demodulation. Demodulates the PM waveform by modulating the Hilbert transform of y by a complex exponential of frequency $-fc$ Hz and obtains the instantaneous phase of the result.</p>
ppm	<p>Pulse-position demodulation. Finds the pulse positions of a pulse-position modulated signal y. For correct demodulation, the pulses cannot overlap. x is length <code>length(t)*fc/fs</code>.</p>
pwm	<p>Pulse-width demodulation. Finds the pulse widths of a pulse-width modulated signal y. <code>demod</code> returns in x a vector whose elements specify the width of each pulse in fractions of a period. The pulses in y should start at the beginning of each carrier period, that is, they should be left justified.</p>

Method	Description
qam	<p>Quadrature amplitude demodulation.</p> <p><code>[x1,x2] = demod(y,fc,fs,'qam')</code> multiplies <code>y</code> by a cosine and a sine of frequency <code>fc</code> and applies a fifth-order Butterworth lowpass filter using <code>filtfilt</code>.</p> <pre>x1 = y.*cos(2*pi*fc*t); x2 = y.*sin(2*pi*fc*t); [b,a] = butter(5,fc*2/fs); x1 = filtfilt(b,a,x1); x2 = filtfilt(b,a,x2);</pre>

The default method is 'am'. In all cases except 'ppm' and 'pwm', `x` is the same size as `y`.

If `y` is a matrix, `demod` demodulates its columns.

`x = demod(y,fc,fs,'pwm','centered')` finds the pulse widths assuming they are centered at the beginning of each period. `x` is length `length(y)*fc/fs`.

See Also

`modulate` | `mskdemod` | `pamdemod` | `pmdemod` | `qamdemod` | `vco` | `fskdemod` | `genqamdemod`

Introduced before R2006a

design

Apply design method to filter specification object

Syntax

```

filt = design(D)
filt = design(D,METHOD)
filt = design(D,METHOD,PARAM1,VALUE1,PARAM2,VALUE2,...)
filt = design(D,METHOD,OPTS)

```

Description

`filt = design(D)` uses the filter specifications object `D` to generate a filter `filt`. When you do not provide a design method as an input argument, `design` uses a default design method. Use `designmethods(D, 'default')` to see the default design method for your filter specifications object.

`filt = design(D,METHOD)` forces the design method specified by `METHOD`. `METHOD` must be one of the options returned by `designmethods`. Use `designmethods(D, 'default')` to determine which algorithm is used by default.

The design method you provide as the `designmethod` input argument must be one of the methods returned by

```
designmethods(d)
```

To help you design filters more quickly, the input argument `METHOD` accepts a variety of special keywords that force `design` to behave in different ways. The following table presents the keywords you can use for `METHOD` and how `design` responds to the keyword.

Design Method Keyword	Description of the Design Response
'FIR'	Forces <code>design</code> to produce an FIR filter. When no FIR design method exists for object <code>D</code> , <code>design</code> returns an error.

Design Method Keyword	Description of the Design Response
' IIR '	Forces <code>design</code> to produce an IIR filter. When no IIR design method exists for object <code>D</code> , <code>design</code> returns an error.
' ALLFIR '	Produces filters from every applicable FIR design method for the specifications in <code>D</code> , one filter for each design method. As a result, <code>design</code> returns multiple filters in the output object.
' ALLIIR '	Produces filters from every applicable IIR design method for the specifications in <code>D</code> , one filter for each design method. As a result, <code>design</code> returns multiple filters in the output object.
' ALL '	Designs filters using all applicable design methods for the specifications object <code>D</code> . As a result, <code>design</code> returns multiple filters, one for each design method. <code>design</code> uses the design methods in the order that <code>designmethods(D)</code> returns them.

Keywords are not case sensitive. When `design` returns multiple filters in the output object, use indexing to see the individual filters. For example, to see the third filter in `filt`, enter:

```
filt(3)
```

`filt = design(D,METHOD,PARAM1,VALUE1,PARAM2,VALUE2,...)` specifies design-method options. Use `help(D,METHOD)` for complete information on which design-method-specific options are available. You can also use `designopts(D,METHOD)` for a less-detailed listing of the design-method-specific options.

`filt = design(D,METHOD,OPTS)` specifies design-method options using the structure `OPTS`. `OPTS` is usually obtained from `designopts` and then specified as an input to `design`. Use `help(D,METHOD)` for more information on optional inputs.

Examples

Design of Lowpass Filters

Design an FIR equiripple lowpass filter. Specify a passband edge frequency of 0.2π rad/sample and a stopband edge frequency of 0.25π rad/sample. Set the passband ripple to 0.5 dB and the stopband attenuation to 40 dB. Use the default equiripple method.

```
D = fdesign.lowpass('Fp,Fst,Ap,Ast',0.2,0.25,0.5,40);
filt = design(D);
```

Display a pole-zero plot of the design.

```
fvtool(filt,'Analysis','polezero')
```

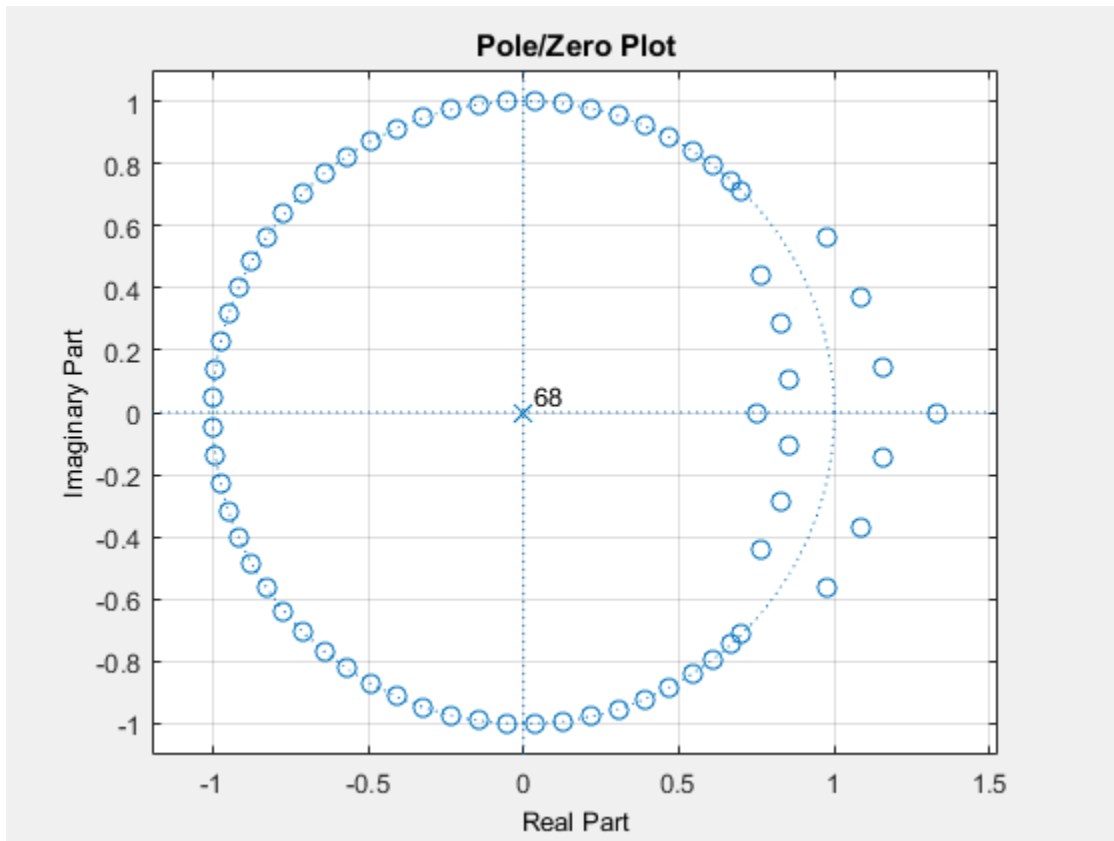

Redesign the filter using the Butterworth method. Matching the passband exactly. Display the frequency response of the filter.

```
filt = design(D,'butter','MatchExactly','passband');
fvtool(filt)
```

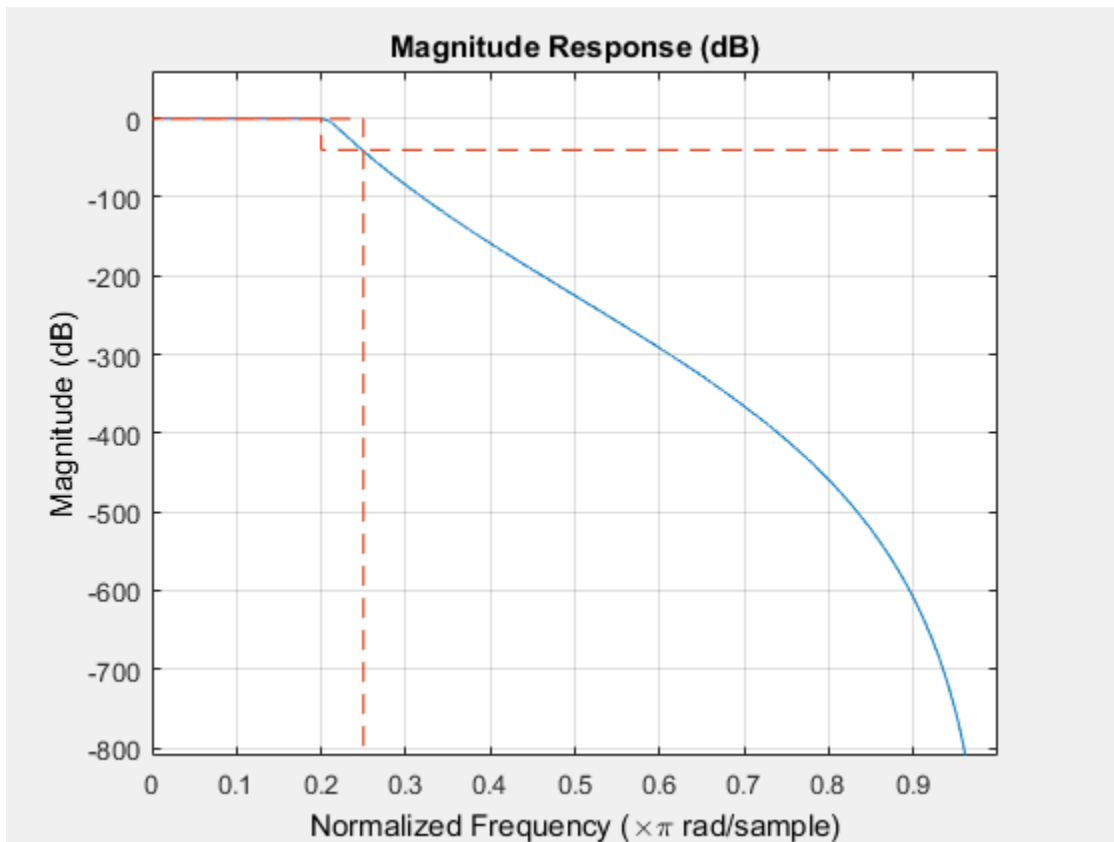

See Also

See Also

[designmethods](#) | [designopts](#)

Introduced in R2009a

designfilt

Design digital filters

Syntax

```
d = designfilt(resp,Name,Value)
```

```
designfilt(d)
```

Description

`d = designfilt(resp,Name,Value)` designs a `digitalFilter` object, `d`, with response type `resp`. Specify the filter further using a set of `Name,Value` pairs. The allowed specification sets depend on the response type, `resp`, and consist of combinations of the following:

- *Frequency constraints* correspond to the frequencies at which a filter exhibits a desired behavior. Examples include 'PassbandFrequency' and 'CutoffFrequency'. (See the complete list under “Name-Value Pair Arguments” on page 1-300.) You must always specify the frequency constraints.
- *Magnitude constraints* describe the filter behavior at particular frequency ranges. Examples include 'PassbandRipple' and 'StopbandAttenuation'. (See the complete list under “Name-Value Pair Arguments” on page 1-300.) `designfilt` provides default values for magnitude constraints left unspecified. In arbitrary-magnitude designs you must always specify the vectors of desired amplitudes.
- 'FilterOrder'. Some design methods let you specify the order. Others produce minimum-order designs. That is, they generate the smallest filters that satisfy the specified constraints.
- 'DesignMethod' is the algorithm used to design the filter. Examples include constrained least squares ('cls') and Kaiser windowing ('kaiserwin'). For some specification sets, there are multiple design methods available to choose from. In other cases, you can use only one method to meet the desired specifications.
- *Design options* are parameters specific to a given design method. Examples include 'Window' for the 'window' method and optimization 'Weights' for arbitrary-magnitude equiripple designs. (See the complete list under “Name-Value Pair

Arguments” on page 1-300.) `designfilt` provides default values for design options left unspecified.

- 'SampleRate' is the frequency at which the filter operates. `designfilt` has a default sample rate of 2 Hz. Using this value is equivalent to working with normalized frequencies.

Note: If you specify an incomplete or inconsistent set of name-value pairs at the command line, `designfilt` offers to open a “Filter Design Assistant” on page 1-309. The assistant helps you design the filter and pastes the corrected MATLAB code on the command line.

If you call `designfilt` from a script or function with an incorrect set of specifications, `designfilt` issues an error message with a link to open a “Filter Design Assistant” on page 1-309. The assistant helps you design the filter, comments out the faulty code in the function or script, and pastes the corrected MATLAB code on the next line.

- Use `filter` in the form `dataOut = filter(d,dataIn)` to filter a signal with a digitalFilter, `d`.
- Use `fvtool` to visualize a digitalFilter, `d`.
- Type `d.Coefficients` to obtain the coefficients of a digitalFilter, `d`. For IIR filters, the coefficients are expressed as second-order sections.
- See digitalFilter for a list of the filtering and analysis functions available for use with digitalFilter objects.

`designfilt(d)` lets you edit an existing digital filter, `d`. It opens a “Filter Design Assistant” on page 1-309 populated with the filter’s specifications, which you can then modify. This is the only way you can edit a digitalFilter object. Its properties are otherwise read-only.

Examples

Lowpass FIR Filter

Design a minimum-order lowpass FIR filter with normalized passband frequency

0.25π rad/s, stopband frequency 0.35π rad/s, passband ripple 0.5 dB, and stopband attenuation 65 dB. Use a Kaiser window to design the filter. Visualize its magnitude response. Use it to filter a vector of random data.

```
lpFilt = designfilt('lowpassfir','PassbandFrequency',0.25, ...  
                  'StopbandFrequency',0.35,'PassbandRipple',0.5, ...  
                  'StopbandAttenuation',65,'DesignMethod','kaiserwin');  
fvtool(lpFilt)
```

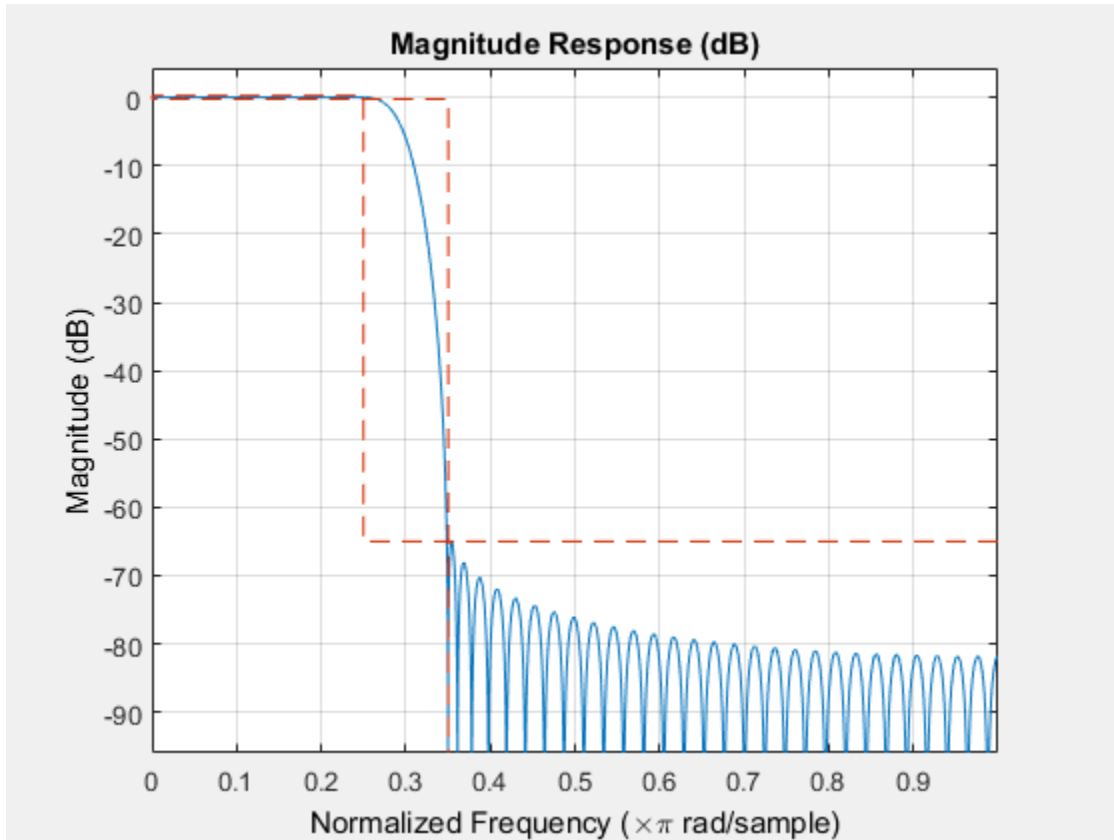

```
dataIn = rand(1000,1);  
dataOut = filter(lpFilt,dataIn);
```

Lowpass IIR Filter

Design a lowpass IIR filter with order 8, passband frequency 35 kHz, and passband ripple 0.2 dB. Specify a sample rate of 200 kHz. Visualize the magnitude response of the filter. Use it to filter a 1000-sample random signal.

```
lpFilt = designfilt('lowpassiir','FilterOrder',8, ...  
    'PassbandFrequency',35e3,'PassbandRipple',0.2, ...  
    'SampleRate',200e3);  
fvtool(lpFilt)
```

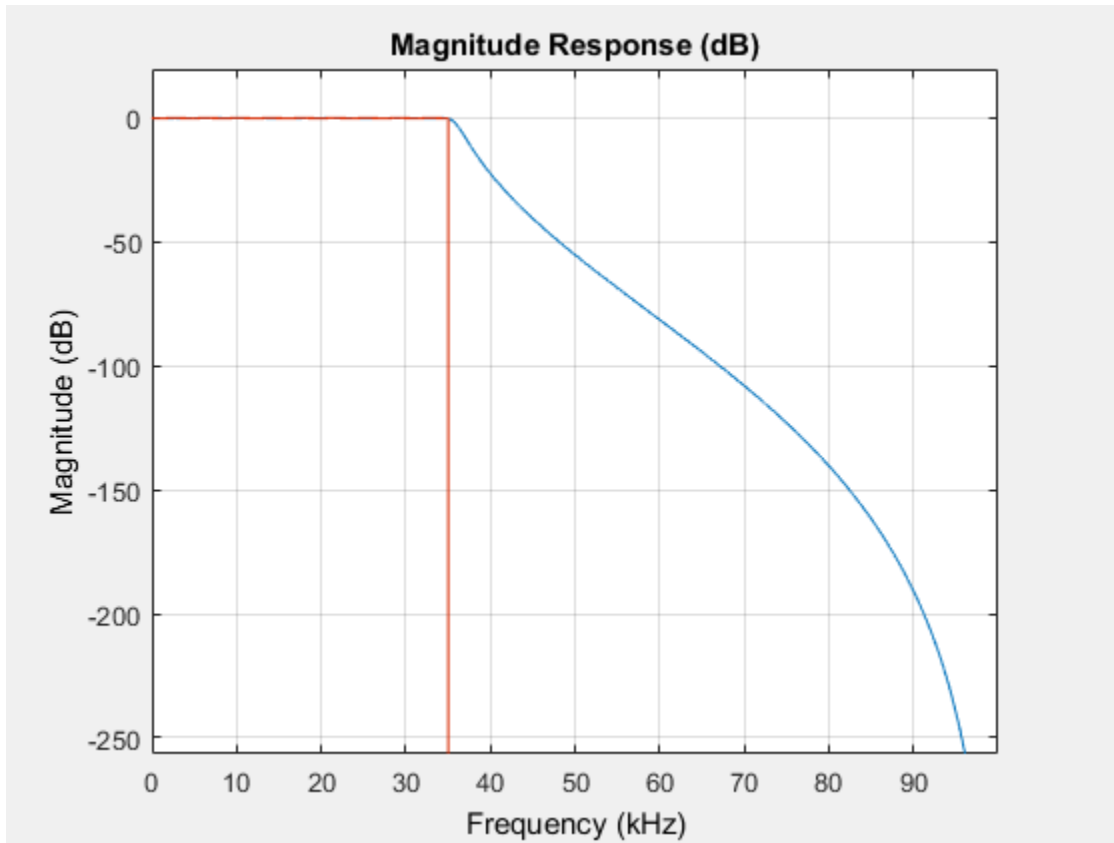

```
dataIn = randn(1000,1);  
dataOut = filter(lpFilt,dataIn);
```

Output the filter coefficients, expressed as second-order sections.

```
sos = lpFilt.Coefficients
```

```
sos =
```

0.2666	0.5333	0.2666	1.0000	-0.8346	0.9073
0.1943	0.3886	0.1943	1.0000	-0.9586	0.7403
0.1012	0.2023	0.1012	1.0000	-1.1912	0.5983
0.0318	0.0636	0.0318	1.0000	-1.3810	0.5090

Highpass FIR Filter

Design a minimum-order highpass FIR filter with normalized stopband frequency 0.25π rad/s, passband frequency 0.35π rad/s, passband ripple 0.5 dB, and stopband attenuation 65 dB. Use a Kaiser window to design the filter. Visualize its magnitude response. Use it to filter 1000 samples of random data.

```
hpFilt = designfilt('highpassfir','StopbandFrequency',0.25, ...  
                  'PassbandFrequency',0.35,'PassbandRipple',0.5, ...  
                  'StopbandAttenuation',65,'DesignMethod','kaiserwin');  
fvtool(hpFilt)
```

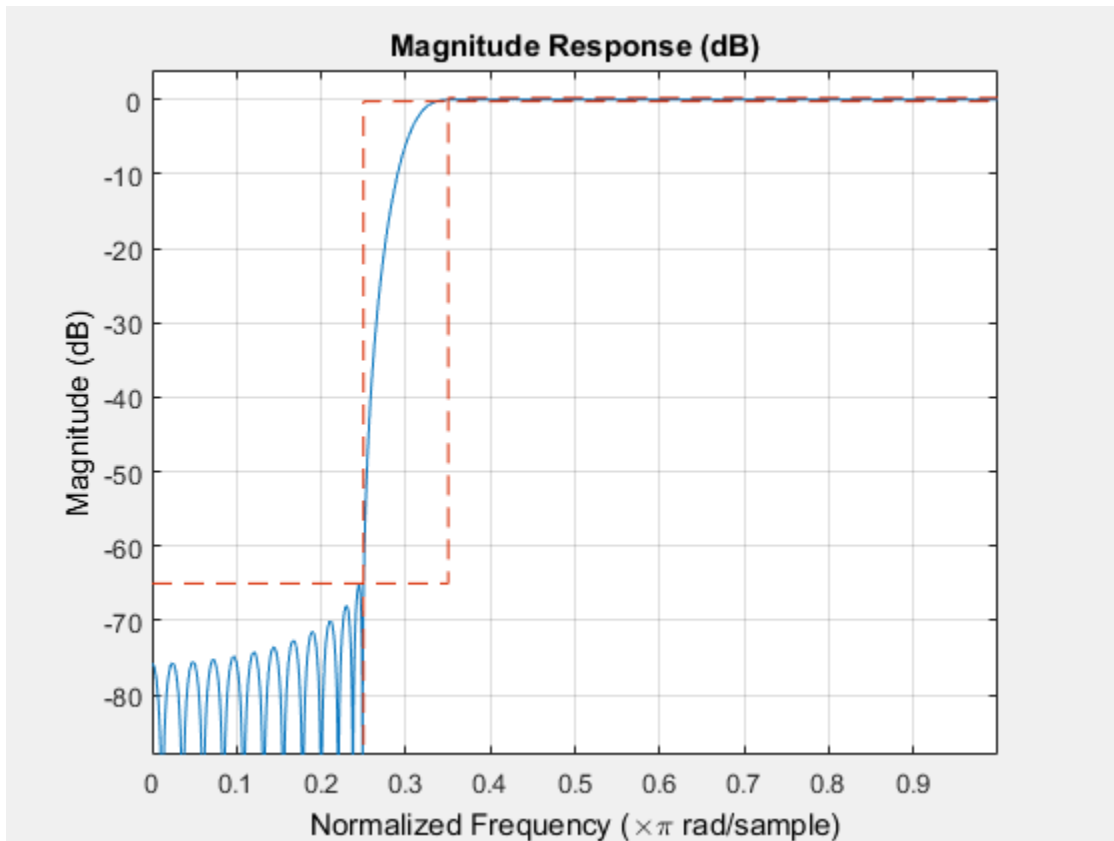

```
dataIn = randn(1000,1);  
dataOut = filter(hpFilt,dataIn);
```

Highpass IIR Filter

Design a highpass IIR filter with order 8, passband frequency 75 kHz, and passband ripple 0.2 dB. Specify a sample rate of 200 kHz. Visualize the filter's magnitude response. Apply the filter to a 1000-sample vector of random data.

```
hpFilt = designfilt('highpassiir','FilterOrder',8, ...  
                  'PassbandFrequency',75e3,'PassbandRipple',0.2, ...  
                  'SampleRate',200e3);
```

```
fvtool(hpFilt)
```

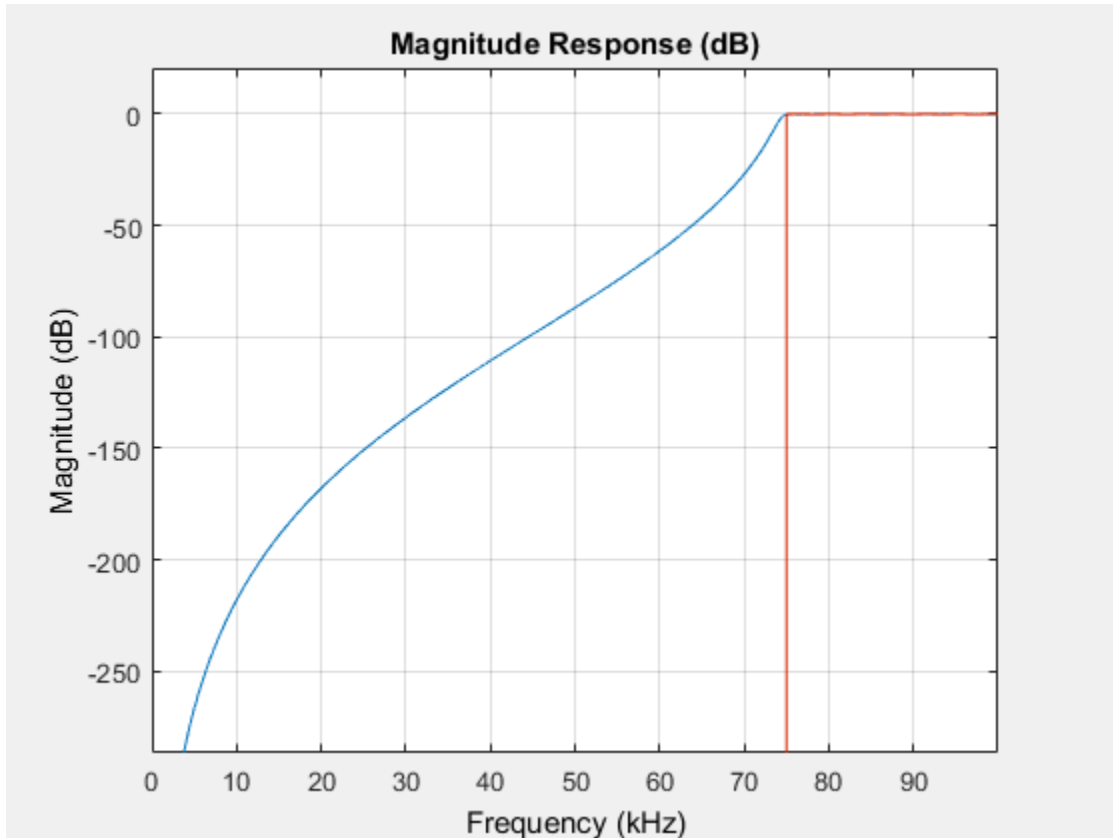

```
dataIn = randn(1000,1);  
dataOut = filter(hpFilt,dataIn);
```

Bandpass FIR Filter

Design a 20th-order bandpass FIR filter with lower cutoff frequency 500 Hz and higher cutoff frequency 560 Hz. The sample rate is 1500 Hz. Visualize the magnitude response of the filter. Use it to filter a random signal containing 1000 samples.

```
bpFilt = designfilt('bandpassfir','FilterOrder',20, ...  
                  'CutoffFrequency1',500,'CutoffFrequency2',560, ...
```

```
'SampleRate',1500);
fvtool(bpFilt)
```

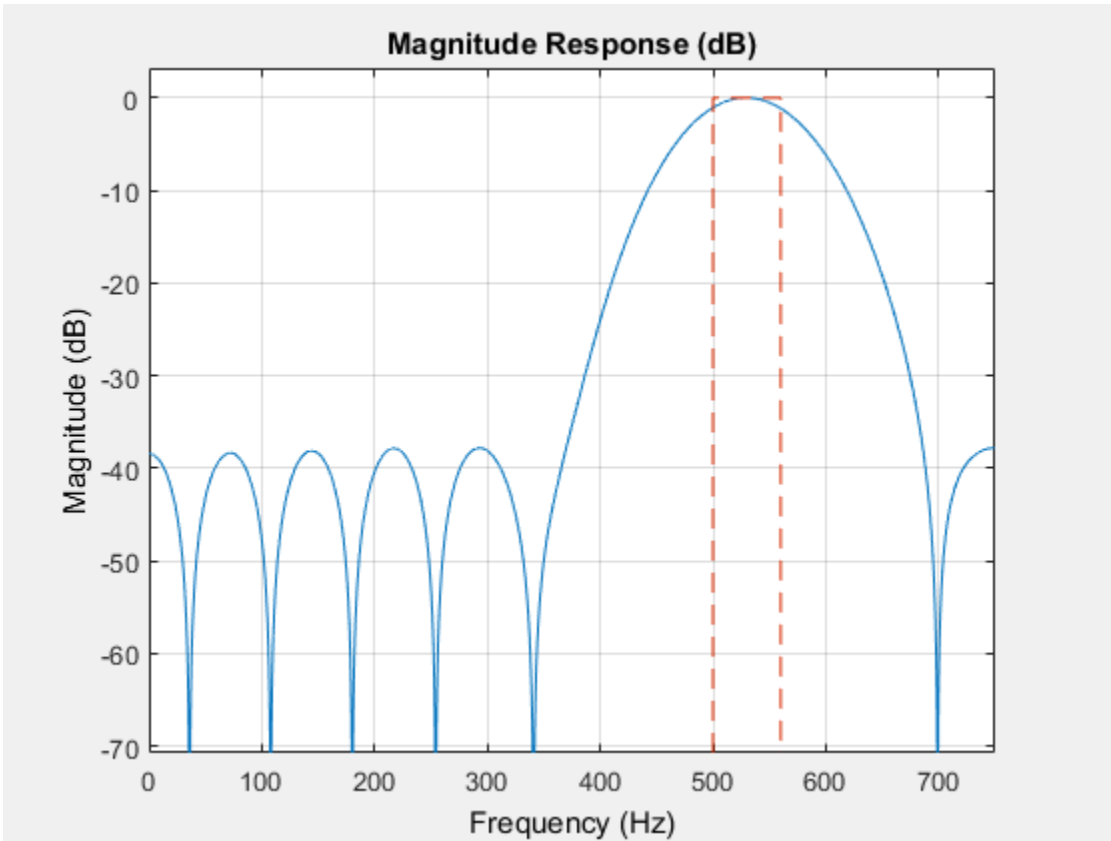

```
dataIn = randn(1000,1);
dataOut = filter(bpFilt,dataIn);
```

Output the filter coefficients.

```
b = bpFilt.Coefficients
```

```
b =
```

```
-0.0113    0.0067    0.0125   -0.0445    0.0504    0.0101   -0.1070    0.1407   -0.0...
```

Bandpass IIR Filter

Design a 20th-order bandpass IIR filter with lower 3-dB frequency 500 Hz and higher 3-dB frequency 560 Hz. The sample rate is 1500 Hz. Visualize the frequency response of the filter. Use it to filter a 1000-sample random signal.

```
bpFilt = designfilt('bandpassiir','FilterOrder',20, ...  
    'HalfPowerFrequency1',500,'HalfPowerFrequency2',560, ...  
    'SampleRate',1500);  
fvtool(bpFilt)
```

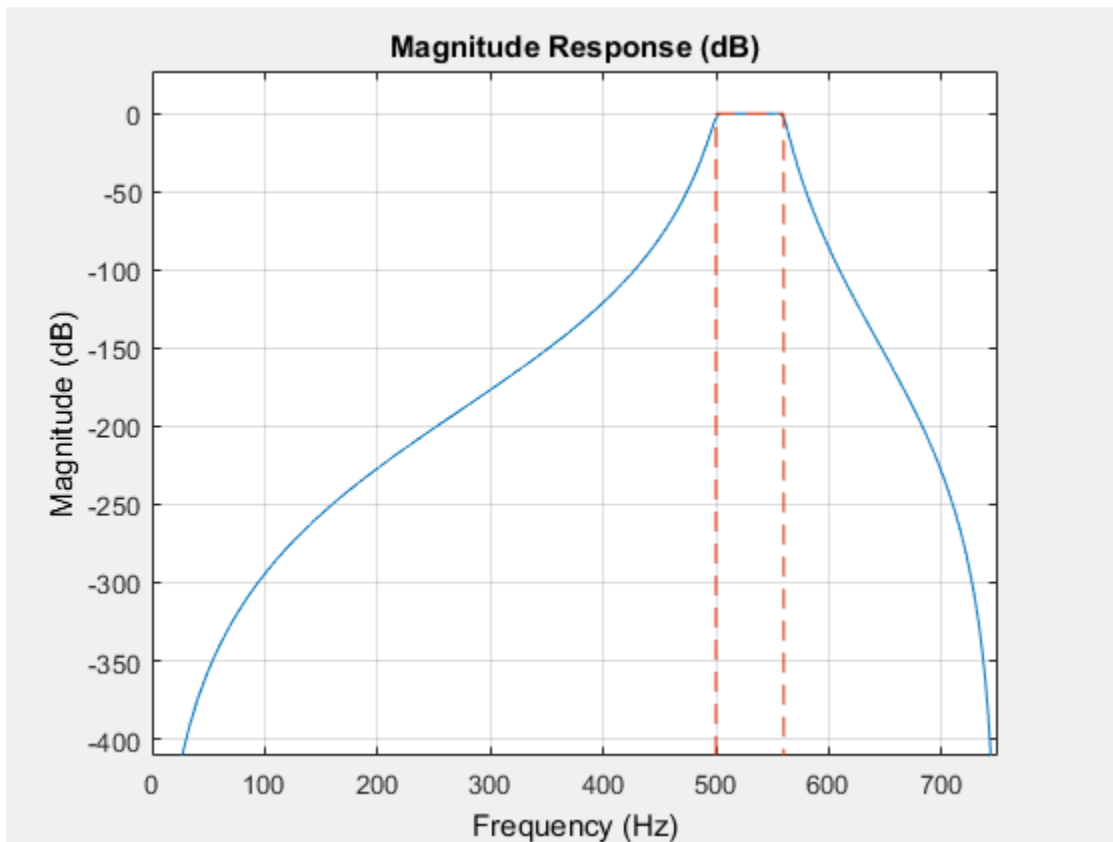

```
dataIn = randn(1000,1);  
dataOut = filter(bpFilt,dataIn);
```

Bandstop FIR Filter

Design a 20th-order bandstop FIR filter with lower cutoff frequency 500 Hz and higher cutoff frequency 560 Hz. The sample rate is 1500 Hz. Visualize the magnitude response of the filter. Use it to filter 1000 samples of random data.

```
bsFilt = designfilt('bandstopfir','FilterOrder',20, ...  
                  'CutoffFrequency1',500,'CutoffFrequency2',560, ...  
                  'SampleRate',1500);  
fvtool(bsFilt)
```

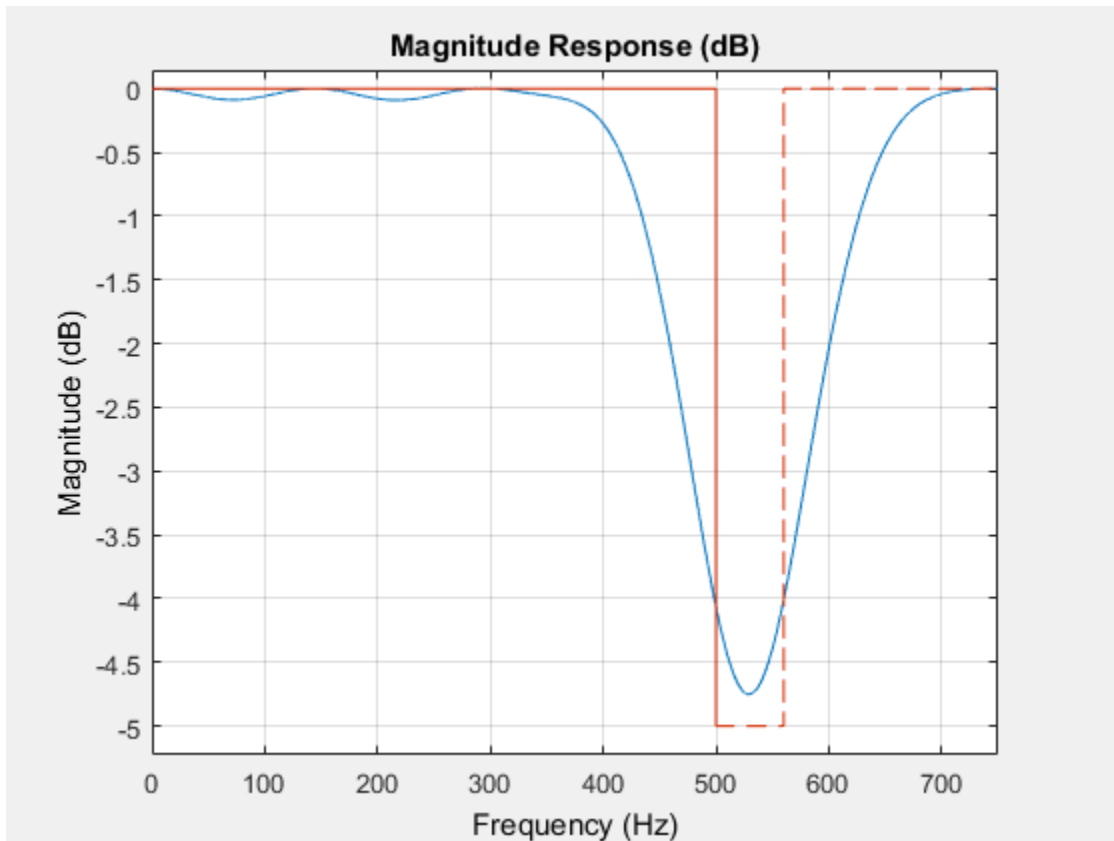

```
dataIn = randn(1000,1);  
dataOut = filter(bsFilt,dataIn);
```

Bandstop IIR Filter

Design a 20th-order bandstop IIR filter with lower 3-dB frequency 500 Hz and higher 3-dB frequency 560 Hz. The sample rate is 1500 Hz. Visualize the magnitude response of the filter. Use it to filter 1000 samples of random data.

```
bsFilt = designfilt('bandstopiir','FilterOrder',20, ...  
                  'HalfPowerFrequency1',500,'HalfPowerFrequency2',560, ...  
                  'SampleRate',1500);  
fvtool(bsFilt)
```

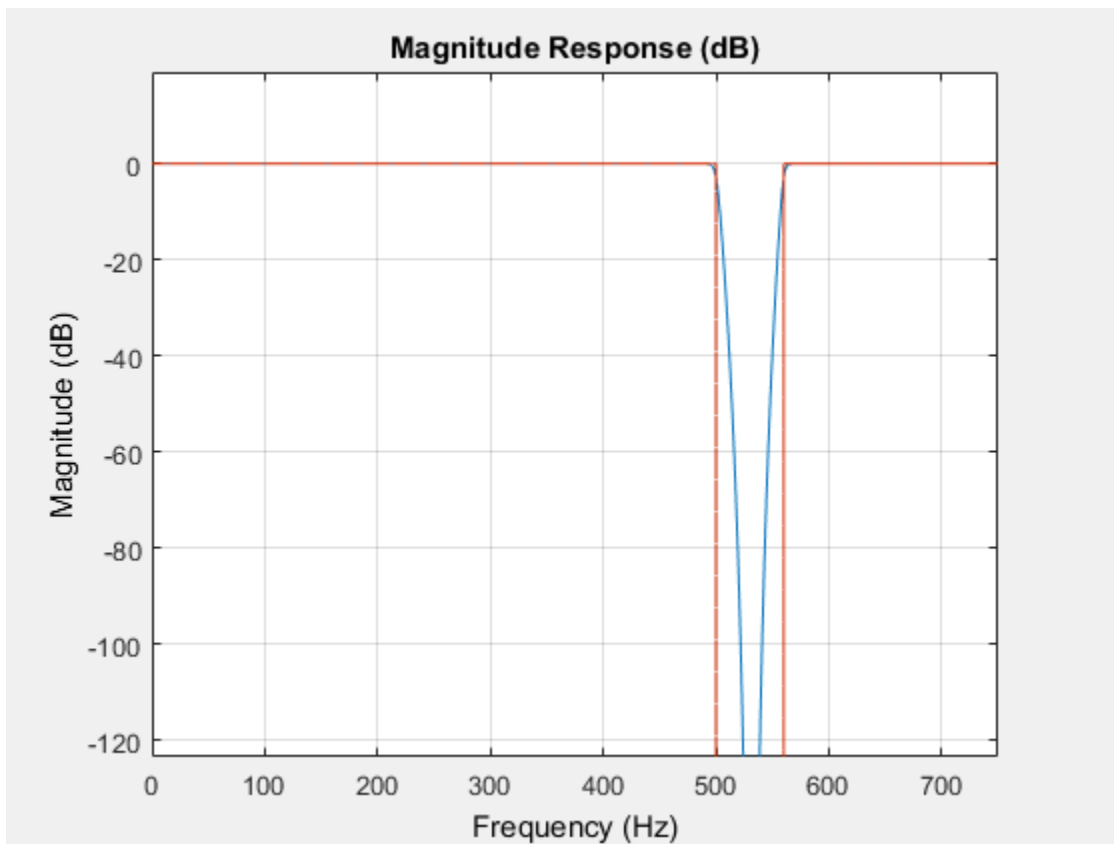

```
dataIn = randn(1000,1);
```

```
dataOut = filter(bsFilt,dataIn);
```

FIR Differentiator

Design a full-band differentiator filter of order 7. Display its zero-phase response. Use it to filter a 1000-sample vector of random data.

```
dFilt = designfilt('differentiatorfir','FilterOrder',7);  
fvtool(dFilt,'MagnitudeDisplay','Zero-phase')
```

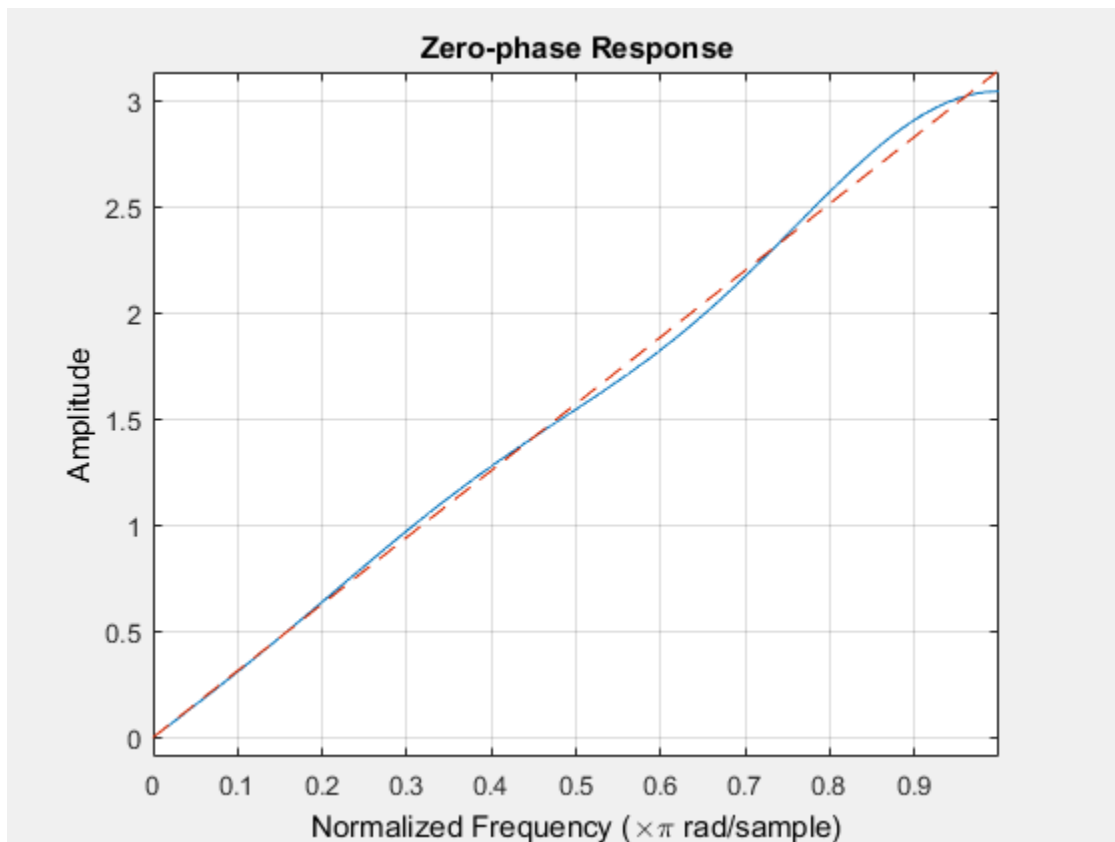

```
dataIn = randn(1000,1);  
dataOut = filter(dFilt,dataIn);
```

FIR Hilbert Transformer

Design a Hilbert transformer of order 18. Specify a normalized transition width of 0.25π rad/s. Display in linear units the magnitude response of the filter. Use it to filter a 1000-sample vector of random data.

```
hFilt = designfilt('hilbertfir','FilterOrder',18,'TransitionWidth',0.25);  
fvtool(hFilt,'MagnitudeDisplay','magnitude')
```

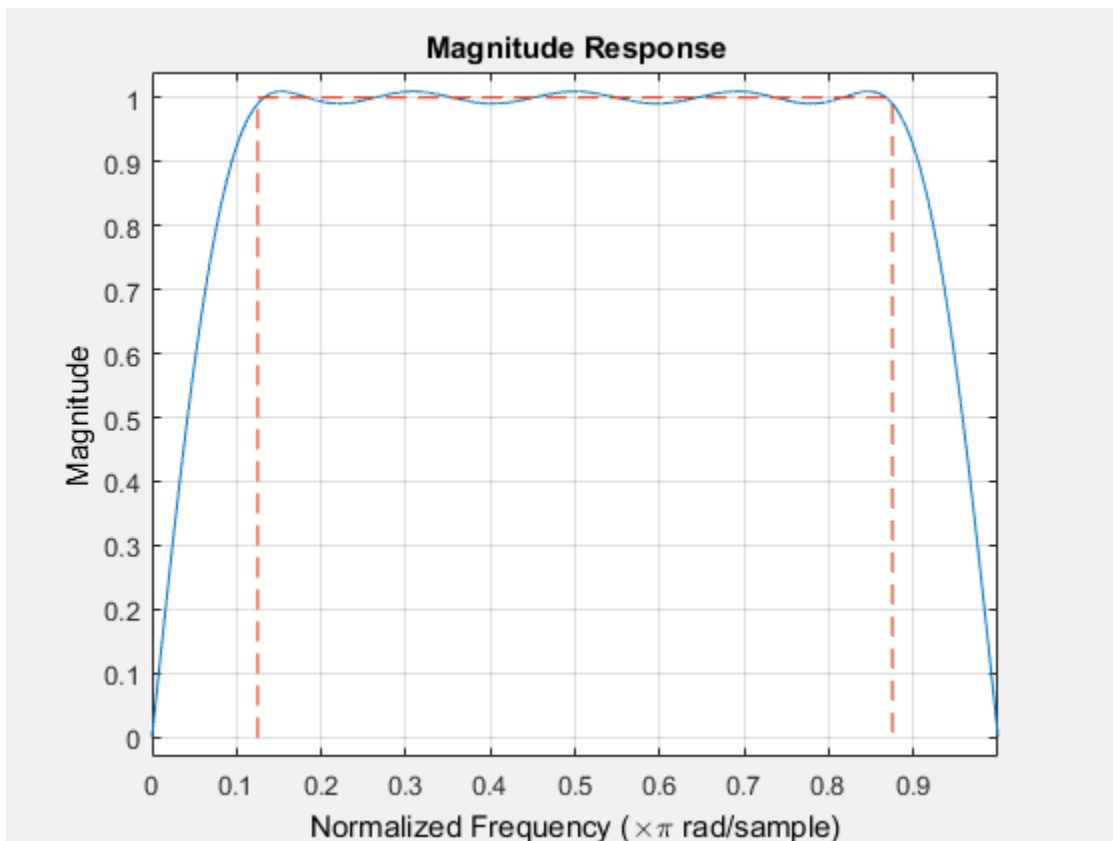

```
dataIn = randn(1000,1);  
dataOut = filter(hFilt,dataIn);
```

Arbitrary-Magnitude FIR Filter

You are given a signal sampled at 1 kHz. Design a filter that stops frequencies between 100 Hz and 350 Hz and frequencies greater than 400 Hz. Specify a filter order of 60. Visualize the frequency response of the filter. Use it to filter a 1000-sample random signal.

```
mbFilt = designfilt('arbmagfir','FilterOrder',60, ...  
                  'Frequencies',0:50:500,'Amplitudes',[1 1 1 0 0 0 0 1 1 0 0], ...  
                  'SampleRate',1000);  
fvtool(mbFilt)
```

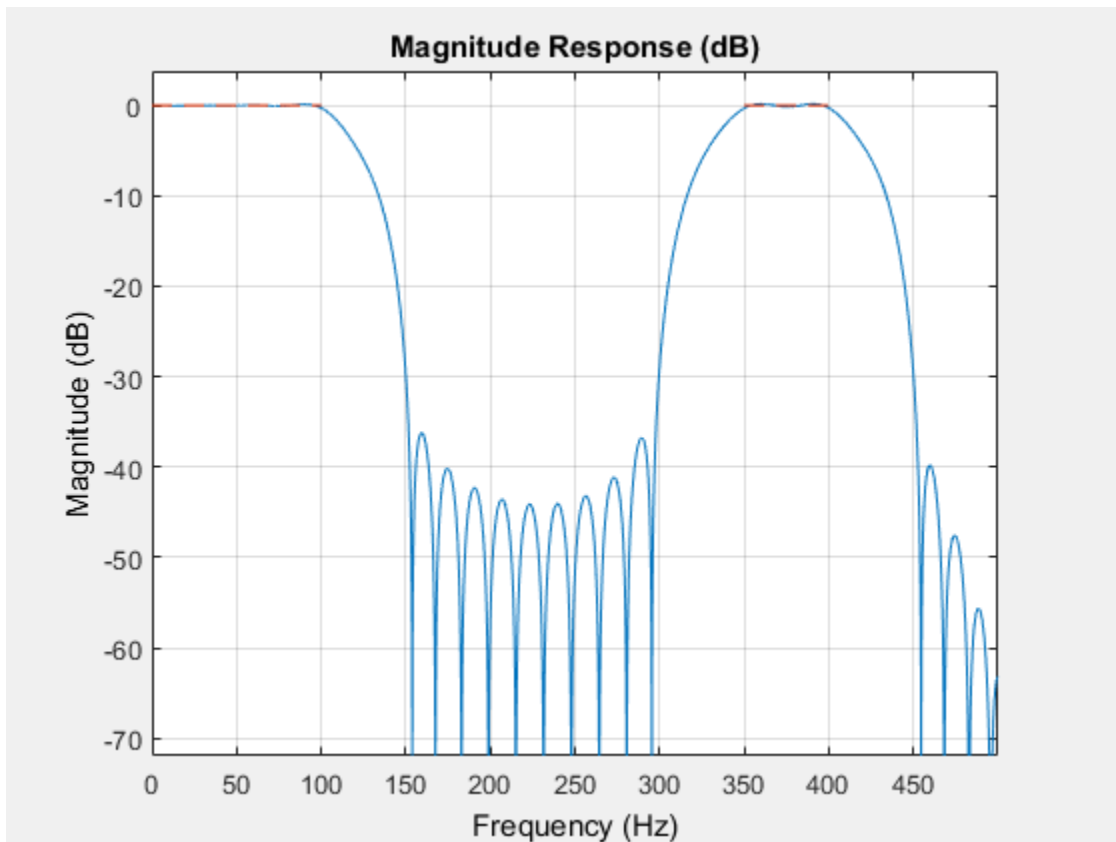

```
dataIn = randn(1000,1);
```

```
dataOut = filter(mbFilt,dataIn);
```

- “Practical Introduction to Digital Filter Design”
- “Filter Design Gallery”
- “Practical Introduction to Digital Filtering”

Input Arguments

resp — Filter response and type

```
'lowpassfir' | 'lowpassiir' | 'highpassfir' | 'highpassiir' |  
'bandpassfir' | 'bandpassiir' | 'bandstopfir' | 'bandstopiir' |  
'differentiatorfir' | 'hilbertfir' | 'arbmagfir'
```

Filter response and type, specified as a character vector. Click one of the possible values of `resp` to expand a table of allowed specification sets.

'lowpassfir'

Choose this option to design a finite impulse response (FIR) lowpass filter. This example uses the fifth specification set from the following table.

```
d = designfilt('lowpassfir', ...           % Response type  
              'FilterOrder',25, ...       % Filter order  
              'PassbandFrequency',400, ... % Frequency constraints  
              'StopbandFrequency',550, ...  
              'DesignMethod','ls', ...    % Design method  
              'PassbandWeight',1, ...     % Design method options  
              'StopbandWeight',2, ...  
              'SampleRate',2000)         % Sample rate
```

- If you omit 'FilterOrder' (when required), or any of the frequency constraints, `designfilt` throws an error.
- If you omit the magnitude constraints, `designfilt` uses default values.
- If you omit 'DesignMethod', `designfilt` uses the default design method for the specification set.
- If you omit the design method options, `designfilt` uses the defaults for the design method of choice.
- If you omit 'SampleRate', `designfilt` sets it to 2 Hz.

Filter Order Argument Names	Frequency Constraint Argument Names	Magnitude Constraint Argument Names	'DesignMethod' Argument Values	Design Option Argument Names
N/A (Minimum-order design)	'PassbandFrequency'	'PassbandRipple'	'equiripple' (default)	N/A
	'StopbandFrequency'	'StopbandAttenuation'	'kaiserwin'	'ScalePassband'
'FilterOrder'	'HalfPowerFrequency'	N/A	'maxflat'	N/A
'FilterOrder'	'CutoffFrequency'	N/A	'window'	'Window' 'ScalePassband'
'FilterOrder'	'CutoffFrequency'	'PassbandRipple' 'StopbandAttenuation'	'cls'	'PassbandOffset' 'ZeroPhase'
'FilterOrder'	'PassbandFrequency' 'StopbandFrequency'	N/A	'equiripple' (default)	'PassbandWeight' 'StopbandWeight'
			'ls'	'PassbandWeight' 'StopbandWeight'

'lowpassiir'

Choose this option to design an infinite impulse response (IIR) lowpass filter. This example uses the first specification set from the following table.

```
d = designfilt('lowpassiir', ...           % Response type
    'PassbandFrequency',400, ...         % Frequency constraints
    'StopbandFrequency',550, ...
    'PassbandRipple',4, ...             % Magnitude constraints
    'StopbandAttenuation',55, ...
    'DesignMethod','ellip', ...         % Design method
    'MatchExactly','passband', ...     % Design method options
    'SampleRate',2000)                  % Sample rate
```

- If you omit 'FilterOrder' (when required), or any of the frequency constraints, `designfilt` throws an error.
- If you omit the magnitude constraints, `designfilt` uses default values.
- If you omit 'DesignMethod', `designfilt` uses the default design method for the specification set.

- If you omit the design method options, `designfilt` uses the defaults for the design method of choice.
- If you omit `'SampleRate'`, `designfilt` sets it to 2 Hz.

Filter Order Argument Names	Frequency Constraint Argument Names	Magnitude Constraint Argument Names	'DesignMethod' Argument Values	Design Option Argument Names
N/A (Minimum-order design)	'PassbandFrequency'	'PassbandRipple'	'butter' (default)	'MatchExactly'
	'StopbandFrequency'	'StopbandAttenuation'	'cheby1'	'MatchExactly'
			'cheby2'	'MatchExactly'
			'ellip'	'MatchExactly'
'FilterOrder'	'HalfPowerFrequency'	N/A	'butter'	N/A
'FilterOrder'	'PassbandFrequency'	'PassbandRipple'	'cheby1'	N/A
'FilterOrder'	'PassbandFrequency'	'PassbandRipple'	'ellip'	N/A
		'StopbandAttenuation'		
'FilterOrder'	'StopbandFrequency'	'StopbandAttenuation'	'cheby2'	N/A
'NumeratorOrder'	'HalfPowerFrequency'	N/A	'butter'	N/A
'DenominatorOrder'				

'highpassfir'

Choose this option to design a finite impulse response (FIR) highpass filter. This example uses the first specification set from the following table.

```
d = designfilt('highpassfir', ...           % Response type
    'StopbandFrequency', 400, ...         % Frequency constraints
    'PassbandFrequency', 550, ...
    'StopbandAttenuation', 55, ...       % Magnitude constraints
    'PassbandRipple', 4, ...
    'DesignMethod', 'kaiserwin', ...     % Design method
    'ScalePassband', false, ...         % Design method options
    'SampleRate', 2000)                 % Sample rate
```

- If you omit `'FilterOrder'` (when required), or any of the frequency constraints, `designfilt` throws an error.

- If you omit the magnitude constraints, `designfilt` uses default values.
- If you omit 'DesignMethod', `designfilt` uses the default design method for the specification set.
- If you omit the design method options, `designfilt` uses the defaults for the design method of choice.
- If you omit 'SampleRate', `designfilt` sets it to 2 Hz.

Filter Order Argument Names	Frequency Constraint Argument Names	Magnitude Constraint Argument Names	'DesignMethod' Argument Values	Design Option Argument Names
N/A (Minimum-order design)	'StopbandFrequency'	'StopbandAttenuation'	'equiripple' (default)	N/A
	'PassbandFrequency'	'PassbandRipple'	'kaiserwin'	'ScalePassband'
'FilterOrder'	'CutoffFrequency'	N/A	'window'	'Window' 'ScalePassband'
'FilterOrder'	'CutoffFrequency'	'StopbandAttenuation' 'PassbandRipple'	'cls'	'PassbandOffset' 'ZeroPhase'
'FilterOrder'	'StopbandFrequency' 'PassbandFrequency'	N/A	'equiripple' (default)	'PassbandWeight' 'StopbandWeight'
			'ls'	'PassbandWeight' 'StopbandWeight'

'highpassiir'

Choose this option to design an infinite impulse response (IIR) highpass filter. This example uses the first specification set from the following table.

```
d = designfilt('highpassiir', ... % Response type
    'StopbandFrequency',400, ... % Frequency constraints
    'PassbandFrequency',550, ...
    'StopbandAttenuation',55, ... % Magnitude constraints
    'PassbandRipple',4, ...
    'DesignMethod','cheby1', ... % Design method
    'MatchExactly','stopband', ... % Design method options
    'SampleRate',2000) % Sample rate
```

- If you omit 'FilterOrder' (when required), or any of the frequency constraints, `designfilt` throws an error.
- If you omit the magnitude constraints, `designfilt` uses default values.
- If you omit 'DesignMethod', `designfilt` uses the default design method for the specification set.
- If you omit the design method options, `designfilt` uses the defaults for the design method of choice.
- If you omit 'SampleRate', `designfilt` sets it to 2 Hz.

Filter Order Argument Names	Frequency Constraint Argument Names	Magnitude Constraint Argument Names	'DesignMethod' Argument Values	Design Option Argument Names
N/A (Minimum-order design)	'StopbandFrequency'	'StopbandAttenuation'	'butter' (default)	'MatchExactly'
	'PassbandFrequency'	'PassbandRipple'	'cheby1'	'MatchExactly'
			'cheby2'	'MatchExactly'
			'ellip'	'MatchExactly'
'FilterOrder'	'HalfPowerFrequency'	N/A	'butter'	N/A
'FilterOrder'	'PassbandFrequency'	'PassbandRipple'	'cheby1'	N/A
'FilterOrder'	'PassbandFrequency'	'StopbandAttenuation' 'PassbandRipple'	'ellip'	N/A
'FilterOrder'	'StopbandFrequency'	'StopbandAttenuation'	'cheby2'	N/A
'NumeratorOrder'	'HalfPowerFrequency'	N/A	'butter'	N/A
'DenominatorOrder'				

'bandpassfir'

Choose this option to design a finite impulse response (FIR) bandpass filter. This example uses the fourth specification set from the following table.

```
d = designfilt('bandpassfir', ...           % Response type
              'FilterOrder',86, ...        % Filter order
              'StopbandFrequency1',400, ... % Frequency constraints
              'PassbandFrequency1',450, ...
              'PassbandFrequency2',600, ...
```

```
'StopbandFrequency2',650, ...
'DesignMethod','ls', ...           % Design method
'StopbandWeight1',1, ...           % Design method options
'PassbandWeight', 2, ...
'StopbandWeight2',3, ...
'SampleRate',2000)                 % Sample rate
```

- If you omit 'FilterOrder' (when required), or any of the frequency constraints, `designfilt` throws an error.
- If you omit the magnitude constraints, `designfilt` uses default values.
- If you omit 'DesignMethod', `designfilt` uses the default design method for the specification set.
- If you omit the design method options, `designfilt` uses the defaults for the design method of choice.
- If you omit 'SampleRate', `designfilt` sets it to 2 Hz.

Filter Order Argument Names	Frequency Constraint Argument Names	Magnitude Constraint Argument Names	'DesignMethod' Argument Values	Design Option Argument Names
N/A (Minimum-order design)	'StopbandFrequency1'	'StopbandAttenuation'	'equiripple' (default)	N/A
	'PassbandFrequency1'	'PassbandRipple'	'kaiserwin'	'ScalePassband'
	'PassbandFrequency2'	'StopbandAttenuation'		
	'StopbandFrequency2'			
'FilterOrder'	'CutoffFrequency1'	N/A	'window'	'Window'
	'CutoffFrequency2'			'ScalePassband'
'FilterOrder'	'CutoffFrequency1'	'StopbandAttenuation'	'cls'	'PassbandOffset'
	'CutoffFrequency2'	'PassbandRipple'		'ZeroPhase'
		'StopbandAttenuation'		
'FilterOrder'	'StopbandFrequency1'	N/A	'equiripple' (default)	'StopbandWeight1'
	'PassbandFrequency1'			'PassbandWeight'
	'PassbandFrequency2'			'StopbandWeight2'

Filter Order Argument Names	Frequency Constraint Argument Names	Magnitude Constraint Argument Names	'DesignMethod' Argument Values	Design Option Argument Names
	'StopbandFrequency1'		'ls'	'StopbandWeight1' 'PassbandWeight1' 'StopbandWeight2'

'bandpassiir'

Choose this option to design an infinite impulse response (IIR) bandpass filter. This example uses the first specification set from the following table.

```
d = designfilt('bandpassiir', ...           % Response type
    'StopbandFrequency1',400, ...         % Frequency constraints
    'PassbandFrequency1',450, ...
    'PassbandFrequency2',600, ...
    'StopbandFrequency2',650, ...
    'StopbandAttenuation1',40, ...       % Magnitude constraints
    'PassbandRipple',1, ...
    'StopbandAttenuation2',50, ...
    'DesignMethod','ellip', ...         % Design method
    'MatchExactly','passband', ...     % Design method options
    'SampleRate',2000)                 % Sample rate
```

- If you omit 'FilterOrder' (when required), or any of the frequency constraints, `designfilt` throws an error.
- If you omit the magnitude constraints, `designfilt` uses default values.
- If you omit 'DesignMethod', `designfilt` uses the default design method for the specification set.
- If you omit the design method options, `designfilt` uses the defaults for the design method of choice.
- If you omit 'SampleRate', `designfilt` sets it to 2 Hz.

Filter Order Argument Names	Frequency Constraint Argument Names	Magnitude Constraint Argument Names	'DesignMethod' Argument Values	Design Option Argument Names
N/A (Minimum-order design)	'StopbandFrequency1'	'StopbandAttenuation1'	'butter' (default)	'MatchExactly'

Filter Order Argument Names	Frequency Constraint Argument Names	Magnitude Constraint Argument Names	'DesignMethod' Argument Values	Design Option Argument Names
	'PassbandFrequency1'	'PassbandRipple'	'cheby1'	'MatchExactly'
	'PassbandFrequency1'	'StopbandAttenuation2'	'cheby2'	'MatchExactly'
	'StopbandFrequency1'		'ellip'	'MatchExactly'
'FilterOrder'	'HalfPowerFrequency1'	N/A	'butter'	N/A
	'HalfPowerFrequency1'			
'FilterOrder'	'PassbandFrequency1'	'PassbandRipple'	'cheby1'	N/A
	'PassbandFrequency1'			
'FilterOrder'	'PassbandFrequency1'	'StopbandAttenuation2'	'ellip'	N/A
	'PassbandFrequency1'	'PassbandRipple'		
		'StopbandAttenuation2'		
'FilterOrder'	'StopbandFrequency1'	'StopbandAttenuation2'	'cheby2'	N/A
	'StopbandFrequency1'			

'bandstopfir'

Choose this option to design a finite impulse response (FIR) bandstop filter. This example uses the fourth specification set from the following table.

```
d = designfilt('bandstopfir', ...           % Response type
    'FilterOrder',32, ...                   % Filter order
    'PassbandFrequency1',400, ...          % Frequency constraints
    'StopbandFrequency1',500, ...
    'StopbandFrequency2',700, ...
    'PassbandFrequency2',850, ...
    'DesignMethod','ls', ...              % Design method
    'PassbandWeight1',1, ...              % Design method options
    'StopbandWeight1',3, ...
    'PassbandWeight2',5, ...
    'SampleRate',2000)                   % Sample rate
```

- If you omit 'FilterOrder' (when required), or any of the frequency constraints, `designfilt` throws an error.
- If you omit the magnitude constraints, `designfilt` uses default values.
- If you omit 'DesignMethod', `designfilt` uses the default design method for the specification set.
- If you omit the design method options, `designfilt` uses the defaults for the design method of choice.
- If you omit 'SampleRate', `designfilt` sets it to 2 Hz.

Filter Order Argument Names	Frequency Constraint Argument Names	Magnitude Constraint Argument Names	'DesignMethod' Argument Values	Design Option Argument Names
N/A (Minimum-order design)	'PassbandFrequency1'	'PassbandRipple1'	'equiripple' (default)	N/A
	'StopbandFrequency1'	'StopbandAttenuation1'	'kaiserwin'	'ScalePassband'
	'StopbandFrequency2'	'PassbandRipple2'		
	'PassbandFrequency2'			
'FilterOrder'	'CutoffFrequency1'	N/A	'window'	'Window'
	'CutoffFrequency2'			'ScalePassband'
'FilterOrder'	'CutoffFrequency1'	'PassbandRipple1'	'cls'	'PassbandOffset'
	'CutoffFrequency2'	'StopbandAttenuation1'		'ZeroPhase'
		'PassbandRipple2'		
'FilterOrder'	'PassbandFrequency1'	N/A	'equiripple' (default)	'PassbandWeight1'
	'StopbandFrequency1'			'StopbandWeight'
	'StopbandFrequency2'			'PassbandWeight2'
	'PassbandFrequency2'		'ls'	'PassbandWeight1'
				'StopbandWeight'
				'PassbandWeight2'

'bandstopiir'

Choose this option to design an infinite impulse response (IIR) bandstop filter. This example uses the first specification set from the following table.

```
d = designfilt('bandstopiir', ...           % Response type
    'PassbandFrequency1',400, ...         % Frequency constraints
    'StopbandFrequency1',500, ...
    'StopbandFrequency2',700, ...
    'PassbandFrequency2',850, ...
    'PassbandRipple1',1, ...             % Magnitude constraints
    'StopbandAttenuation',55, ...
    'PassbandRipple2',1, ...
    'DesignMethod','ellip', ...         % Design method
    'MatchExactly','both', ...         % Design method options
    'SampleRate',2000)                 % Sample rate
```

- If you omit 'FilterOrder' (when required), or any of the frequency constraints, designfilt throws an error.
- If you omit the magnitude constraints, designfilt uses default values.
- If you omit 'DesignMethod', designfilt uses the default design method for the specification set.
- If you omit the design method options, designfilt uses the defaults for the design method of choice.
- If you omit 'SampleRate', designfilt sets it to 2 Hz.

Filter Order Argument Names	Frequency Constraint Argument Names	Magnitude Constraint Argument Names	'DesignMethod' Argument Values	Design Option Argument Names
N/A (Minimum-order design)	'PassbandFrequency1'	'PassbandRipple1'	'butter' (default)	'MatchExactly'
	'StopbandFrequency1'	'StopbandAttenuation'	'cheby1'	'MatchExactly'
	'StopbandFrequency2'	'PassbandRipple2'	'cheby2'	'MatchExactly'
	'PassbandFrequency2'		'ellip'	'MatchExactly'
'FilterOrder'	'HalfPowerFrequency1'	N/A	'butter'	N/A
	'HalfPowerFrequency2'			

Filter Order Argument Names	Frequency Constraint Argument Names	Magnitude Constraint Argument Names	'DesignMethod' Argument Values	Design Option Argument Names
'FilterOrder'	'PassbandFrequency' 'PassbandFrequency'	'PassbandRipple'	'cheby1'	N/A
'FilterOrder'	'PassbandFrequency' 'PassbandFrequency' 'StopbandAttenuat'	'PassbandRipple' 'StopbandAttenuat'	'ellip'	N/A
'FilterOrder'	'StopbandFrequency' 'StopbandFrequency'	'StopbandAttenuat'	'cheby2'	N/A

'differentiatorfir'

Choose this option to design a finite impulse response (FIR) differentiator filter. This example uses the second specification set from the following table.

```
d = designfilt('differentiatorfir', ... % Response type
    'FilterOrder',42, ...           % Filter order
    'PassbandFrequency',400, ...   % Frequency constraints
    'StopbandFrequency',500, ...
    'DesignMethod','equiripple', ... % Design method
    'PassbandWeight',1, ...        % Design method options
    'StopbandWeight',4, ...
    'SampleRate',2000)            % Sample rate
```

- If you omit 'FilterOrder', or any of the frequency constraints when designing a partial-band differentiator, `designfilt` throws an error.
- If you omit 'DesignMethod', `designfilt` uses the default design method for the specification set.
- If you omit the design method options, `designfilt` uses the defaults for the design method of choice.
- If you omit 'SampleRate', `designfilt` sets it to 2 Hz.

Filter Order Argument Names	Frequency Constraint Argument Names	Magnitude Constraint Argument Names	'DesignMethod' Argument Values	Design Option Argument Names
'FilterOrder'	N/A	N/A	'equiripple' (default)	N/A

Filter Order Argument Names	Frequency Constraint Argument Names	Magnitude Constraint Argument Names	'DesignMethod' Argument Values	Design Option Argument Names
			'ls'	N/A
'FilterOrder'	'PassbandFrequency'	N/A	'equiripple' (default)	'PassbandWeight'
	'StopbandFrequency'		'ls'	'StopbandWeight'
				N/A

'hilbertfir'

Choose this option to design a finite impulse response (FIR) Hilbert transformer filter. This example uses the specification set from the following table.

```
d = designfilt('hilbertfir', ...           % Response type
              'FilterOrder',12, ...       % Filter order
              'TransitionWidth',400, ...   % Frequency constraints
              'DesignMethod','ls', ...    % Design method
              'SampleRate',2000)          % Sample rate
```

- If you omit 'FilterOrder' or 'TransitionWidth', designfilt throws an error.
- If you omit 'DesignMethod', designfilt uses the default design method for Hilbert transformers.
- If you omit 'SampleRate', designfilt sets it to 2 Hz.

Filter Order Argument Names	Frequency Constraint Argument Names	Magnitude Constraint Argument Names	'DesignMethod' Argument Values	Design Option Argument Names
'FilterOrder'	'TransitionWidth'	N/A	'equiripple' (default)	N/A
			'ls'	N/A

'arbmagfir'

Choose this option to design a finite impulse response (FIR) filter of arbitrary magnitude response. This example uses the second specification set from the following table.

```
d = designfilt('arbmagfir', ...           % Response type
              'FilterOrder',88, ...       % Filter order
              'NumBands',4, ...           % Frequency constraints
              'BandFrequencies1',[0 20], ...
```



```

'BandFrequencies2',[25 40], ...
'BandFrequencies3',[45 65], ...
'BandFrequencies4',[70 100], ...
'BandAmplitudes1',[2 2], ...      % Magnitude constraints
'BandAmplitudes2',[0 0], ...
'BandAmplitudes3',[1 1], ...
'BandAmplitudes4',[0 0], ...
'DesignMethod','ls', ...         % Design method
'BandWeights1',[1 1]/10, ...     % Design method options
'BandWeights2',[3 1], ...
'BandWeights3',[2 4], ...
'BandWeights4',[5 1], ...
'SampleRate',200)                % Sample rate

```

- If you omit 'FilterOrder', or any of the frequency or magnitude constraints, `designfilt` throws an error.
- If you omit 'DesignMethod', `designfilt` uses the default design method for the specification set.
- If you omit the design method options, `designfilt` uses the defaults for the design method of choice.
- If you omit 'SampleRate', `designfilt` sets it to 2 Hz.

Filter Order Argument Names	Frequency Constraint Argument Names	Magnitude Constraint Argument Names	'DesignMethod' Argument Values	Design Option Argument Names
'FilterOrder'	'Frequencies'	'Amplitudes'	'freqsamp' (default)	'Window'
			'equiripple'	'Weights'
			'ls'	'Weights'
'FilterOrder' 'NumBands'	'BandFrequencies1' ...	'BandAmplitudes1' ...	'equiripple' (default)	'BandWeights1'
				...
			'BandFrequenciesN' 'BandAmplitudesN'	'BandWeightsN'
			'ls'	'BandWeights1'
				...
				'BandWeightsN'

Data Types: char

d — Digital filter

`digitalFilter` object

Digital filter, specified as a `digitalFilter` object generated by `designfilt`. Use this input to change the specifications of an existing `digitalFilter`.

Name-Value Pair Arguments

Specify optional comma-separated pairs of `Name`, `Value` arguments. `Name` is the argument name and `Value` is the corresponding value. `Name` must appear inside single quotes (' '). You can specify several name and value pair arguments in any order as `Name1`, `Value1`, ..., `NameN`, `ValueN`.

Not all combinations of `Name`, `Value` pairs are valid. The valid combinations depend on the filter response that you need and on the frequency and magnitude constraints of your design.

Example: `'FilterOrder',20,'CutoffFrequency',0.4` suffices to specify a lowpass FIR filter.

Filter Order

'FilterOrder' — Filter order

positive integer scalar

Filter order, specified as the comma-separated pair consisting of `'FilterOrder'` and a positive integer scalar.

Data Types: double

'NumeratorOrder' — Numerator order

positive integer scalar

Numerator order of an IIR design, specified as the comma-separated pair consisting of `'NumeratorOrder'` and a positive integer scalar.

Data Types: double

'DenominatorOrder' — Denominator order

positive integer scalar

Denominator order of an IIR design, specified as the comma-separated pair consisting of 'DenominatorOrder' and a positive integer scalar.

Data Types: double

Frequency Constraints

'PassbandFrequency', 'PassbandFrequency1', 'PassbandFrequency2' — Passband frequency

positive scalar

Passband frequency, specified as the comma-separated pair consisting of 'PassbandFrequency' and a positive scalar. The frequency value must be within the Nyquist range.

'PassbandFrequency1' is the lower passband frequency for a bandpass or bandstop design.

'PassbandFrequency2' is the higher passband frequency for a bandpass or bandstop design.

Data Types: double

'StopbandFrequency', 'StopbandFrequency1', 'StopbandFrequency2' — Stopband frequency

positive scalar

Stopband frequency, specified as the comma-separated pair consisting of 'StopbandFrequency' and a positive scalar. The frequency value must be within the Nyquist range.

'StopbandFrequency1' is the lower stopband frequency for a bandpass or bandstop design.

'StopbandFrequency2' is the higher stopband frequency for a bandpass or bandstop design.

Data Types: double

'CutoffFrequency', 'CutoffFrequency1', 'CutoffFrequency2' — 6-dB frequency
positive scalar

6-dB frequency, specified as the comma-separated pair consisting of `'CutoffFrequency'` and a positive scalar. The frequency value must be within the Nyquist range.

`'CutoffFrequency1'` is the lower 6-dB frequency for a bandpass or bandstop design.

`'CutoffFrequency2'` is the higher 6-dB frequency for a bandpass or bandstop design.

Data Types: `double`

`'HalfPowerFrequency'`, `'HalfPowerFrequency1'`, `'HalfPowerFrequency2'` — 3-dB frequency

positive scalar

3-dB frequency, specified as the comma-separated pair consisting of `'HalfPowerFrequency'` and a positive scalar. The frequency value must be within the Nyquist range.

`'HalfPowerFrequency1'` is the lower 3-dB frequency for a bandpass or bandstop design.

`'HalfPowerFrequency2'` is the higher 3-dB frequency for a bandpass or bandstop design.

Data Types: `double`

`'TransitionWidth'` — Width of transition region

positive scalar

Width of the transition region between passband and stopband for a Hilbert transformer, specified as the comma-separated pair consisting of `'TransitionWidth'` and a positive scalar.

Data Types: `double`

`'Frequencies'` — Response frequencies

vector

Response frequencies, specified as the comma-separated pair consisting of `'Frequencies'` and a vector. Use this variable to list the frequencies at which a filter of arbitrary magnitude response has desired amplitudes. The frequencies must be monotonically increasing and lie within the Nyquist range. The first element of the

vector must be either 0 or $-f_s/2$, where f_s is the sample rate, and its last element must be $f_s/2$. If you do not specify a sample rate, `designfilt` uses the default value of 2 Hz.

Data Types: double

'NumBands' — Number of bands

positive integer scalar

Number of bands in a multiband design, specified as the comma-separated pair consisting of `'NumBands'` and a positive integer scalar not greater than 10.

Data Types: double

'BandFrequencies1', '...', 'BandFrequenciesN' — Multiband response frequencies

vectors

Multiband response frequencies, specified as comma-separated pairs consisting of `'BandFrequencies i '` and a numeric vector. `'BandFrequencies i '`, where i runs from 1 through `NumBands`, is a vector containing the frequencies at which the i th band of a multiband design has the desired values, `'BandAmplitudes i '`. `NumBands` can be at most 10. The frequencies must lie within the Nyquist range and must be specified in monotonically increasing order. Adjacent frequency bands must have the same amplitude at their junction.

Data Types: double

Magnitude Constraints

'PassbandRipple', 'PassbandRipple1', 'PassbandRipple2' — Passband ripple

1 (default) | positive scalar

Passband ripple, specified as the comma-separated pair consisting of `'PassbandRipple'` and a positive scalar expressed in decibels.

`'PassbandRipple1'` is the lower-band passband ripple for a bandstop design.

`'PassbandRipple2'` is the higher-band passband ripple for a bandstop design.

Data Types: double

'StopbandAttenuation', 'StopbandAttenuation1', 'StopbandAttenuation2' — Stopband attenuation

60 (default) | positive scalar

Stopband attenuation, specified as the comma-separated pair consisting of 'StopbandAttenuation' and a positive scalar expressed in decibels.

'StopbandAttenuation1' is the lower-band stopband attenuation for a bandpass design.

'StopbandAttenuation2' is the higher-band stopband attenuation for a bandpass design.

Data Types: double

'Amplitudes' — Desired response amplitudes

vector

Desired response amplitudes of an arbitrary magnitude response filter, specified as the comma-separated pair consisting of 'Amplitudes' and a vector. Express the amplitudes in linear units. The vector must have the same length as 'Frequencies'.

Data Types: double

'BandAmplitudes1', '...', 'BandAmplitudesN' — Multiband response amplitudes

vectors

Multiband response amplitudes, specified as comma-separated pairs consisting of 'BandAmplitudes i ' and a numeric vector. 'BandAmplitudes i ', where i runs from 1 through NumBands, is a vector containing the desired amplitudes in the i th band of a multiband design. NumBands can be at most 10. Express the amplitudes in linear units. 'BandAmplitudes i ' must have the same length as 'BandFrequencies i '. Adjacent frequency bands must have the same amplitude at their junction.

Data Types: double

Design Method

'DesignMethod' — Design method

'butter' | 'cheby1' | 'cheby2' | 'cls' | 'ellip' | 'equiripple' |
'freqsamp' | 'kaiserwin' | 'ls' | 'maxflat' | 'window'

Design method, specified as the comma-separated pair consisting of 'DesignMethod' and a character vector. The choice of design method depends on the set of frequency and magnitude constraints that you specify.

- `'butter'` designs a Butterworth IIR filter. Butterworth filters have a smooth monotonic frequency response that is maximally flat in the passband. They sacrifice rolloff steepness for flatness.
- `'cheby1'` designs a Chebyshev type I IIR filter. Chebyshev type I filters have a frequency response that is equiripple in the passband and maximally flat in the stopband. Their passband ripple increases with increasing rolloff steepness.
- `'cheby2'` designs a Chebyshev type II IIR filter. Chebyshev type II filters have a frequency response that is maximally flat in the passband and equiripple in the stopband.
- `'cls'` designs an FIR filter using constrained least squares. The method minimizes the discrepancy between a specified arbitrary piecewise-linear function and the filter's magnitude response. At the same time, it lets you set constraints on the passband ripple and stopband attenuation.
- `'ellip'` designs an elliptic IIR filter. Elliptic filters have a frequency response that is equiripple in both passband and stopband.
- `'equiripple'` designs an equiripple FIR filter using the Parks-McClellan algorithm. Equiripple filters have a frequency response that minimizes the maximum ripple magnitude over all bands.
- `'freqsamp'` designs an FIR filter of arbitrary magnitude response by sampling the frequency response uniformly and taking the inverse Fourier transform.
- `'kaiserwin'` designs an FIR filter using the Kaiser window method. The method truncates the impulse response of an ideal filter and uses a Kaiser window to attenuate the resulting truncation oscillations.
- `'ls'` designs an FIR filter using least squares. The method minimizes the discrepancy between a specified arbitrary piecewise-linear function and the filter's magnitude response.
- `'maxflat'` designs a maximally flat FIR filter. These filters have a smooth monotonic frequency response that is maximally flat in the passband.
- `'window'` uses a least-squares approximation to compute the filter coefficients and then smooths the impulse response with `'Window'`.

Data Types: char

Design Method Options

'Window' — Window

vector | window name character vector | function handle | cell array

Window, specified as the comma-separated pair consisting of 'Window' and a vector of length $N + 1$, where N is the filter order. 'Window' can also be paired with a window name or function handle that specifies the function used to generate the window. Any such function must take $N + 1$ as first input. Additional inputs can be passed by specifying a cell array. By default, 'Window' is an empty vector for the 'freqsamp' design method and @hamming for the 'window' design method.

For a list of available windows, see “Windows”.

Example: 'Window', hann(N+1) and 'Window', (1-cos(2*pi*(0:N)/N))/2 both specify a Hann window to use with a filter of order N.

Example: 'Window', 'hamming' specifies a Hamming window of the required order.

Example: 'Window', @mywindow lets you define your own window function.

Example: 'Window', {@kaiser,0.5} specifies a Kaiser window of the required order with shape parameter 0.5.

Data Types: double | char | function_handle | cell

'MatchExactly' — Band to match exactly

'stopband' | 'passband' | 'both'

Band to match exactly, specified as the comma-separated pair consisting of 'MatchExactly' and either 'stopband', 'passband', or 'both'. 'both' is available only for the elliptic design method, where it is the default. 'stopband' is the default for the 'butter' and 'cheby2' methods. 'passband' is the default for 'cheby1'.

Data Types: char

'PassbandOffset' — Passband offset

0 (default) | positive scalar

Passband offset, specified as the comma-separated pair consisting of 'PassbandOffset' and a positive scalar expressed in decibels. 'PassbandOffset' specifies the filter gain in the passband.

Example: 'PassbandOffset', 0 results in a filter with unit gain in the passband.

Example: 'PassbandOffset', 2 results in a filter with a passband gain of 2 dB or 1.259.

Data Types: double

'ScalePassband' — Scale passband

true (default) | false

Scale passband, specified as the comma-separated pair consisting of `'ScalePassband'` and a logical scalar. When you set `'ScalePassband'` to `true`, the passband is scaled, after windowing, so that the filter has unit gain at zero frequency.

Example: `'Window',{@kaiser,0.1},'ScalePassband',true` help specify a filter whose magnitude response at zero frequency is exactly 0 dB. This is not the case when you specify `'ScalePassband',false`. To verify, visualize the filter with `fvtool` and zoom in.

Data Types: logical

'ZeroPhase' — Zero phase

false (default) | true

Zero phase, specified as the comma-separated pair consisting of `'ZeroPhase'` and a logical scalar. When you set `'ZeroPhase'` to `true`, the zero-phase response of the resulting filter is always positive. This lets you perform spectral factorization on the result and obtain a minimum-phase filter from it.

Data Types: logical

'PassbandWeight', 'PassbandWeight1', 'PassbandWeight2' — Passband optimization weight

1 (default) | positive scalar

Passband optimization weight, specified as the comma-separated pair consisting of `'PassbandWeight'` and a positive scalar.

`'PassbandWeight1'` is the lower-band passband optimization weight for a bandstop FIR design.

`'PassbandWeight2'` is the higher-band passband optimization weight for a bandstop FIR design.

Data Types: double

'StopbandWeight', 'StopbandWeight1', 'StopbandWeight2' — Stopband optimization weight

1 (default) | positive scalar

Stopband optimization weight, specified as the comma-separated pair consisting of `'StopbandWeight'` and a positive scalar.

'StopbandWeight1' is the lower-band stopband optimization weight for a bandpass FIR design.

'StopbandWeight2' is the higher-band stopband optimization weight for a bandpass FIR design.

Data Types: double

'Weights' — Optimization weights

1 (default) | positive scalar | vector

Optimization weights, specified as the comma-separated pair consisting of 'Weights' and a positive scalar or a vector of the same length as 'Amplitudes'.

Data Types: double

'BandWeights1', ..., 'BandWeightsN' — Multiband weights

1 (default) | positive scalar | vectors

Multiband weights, specified as comma-separated pairs consisting of 'BandWeights i ' and a set of positive scalars or of vectors. 'BandWeights i ', where i runs from 1 through NumBands, is a scalar or vector containing the optimization weights of the i th band of a multiband design. If specified as a vector, 'BandWeights i ' must have the same length as 'BandAmplitudes i '.

Data Types: double

Sample Rate

'SampleRate' — Sample rate

2 (default) | positive scalar

Sample rate, specified as the comma-separated pair consisting of 'SampleRate' and a positive scalar expressed in hertz. To work with normalized frequencies, set 'SampleRate' to 2, or simply omit it.

Data Types: double

Output Arguments

d — Digital filter

digitalFilter object

Digital filter, returned as a digitalFilter object.

Definitions

Filter Design Assistant

If you specify an incomplete or inconsistent set of design parameters, `designfilt` offers to open a Filter Design Assistant.

(In the argument description for `resp` there is a complete list of valid specification sets for all available response types.)

The assistant behaves differently if you call `designfilt` at the command line or within a script or function.

Filter Design Assistant at the Command Line

You are given a signal sampled at 2 kHz. You are asked to design a lowpass FIR filter that suppresses frequency components higher than 650 Hz. The “cutoff frequency” sounds like a good candidate for a specification parameter. At the MATLAB command line, you type the following.

```
Fsamp = 2e3;
Fctff = 650;
dee = designfilt('lowpassfir','CutoffFrequency',Fctff, ...
                'SampleRate',Fsamp);
```

Something seems to be amiss because this dialog box appears on your screen.

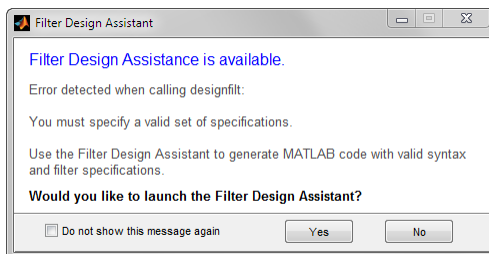

You click **Yes** and get a new dialog box that offers to generate code. You see that the variables you defined before have been inserted where expected.

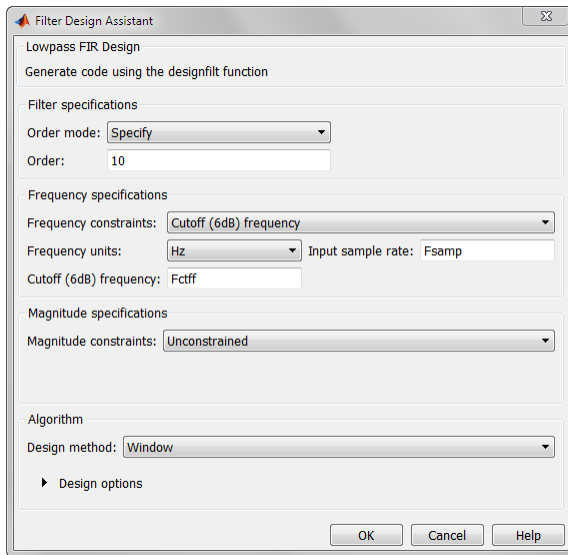

After exploring some of the options offered, you decide to test the corrected filter. You click **OK** and get the following code on the command line.

```
dee = designfilt('lowpassfir', 'FilterOrder', 10, ...
                'CutoffFrequency', Fctff, 'SampleRate', Fsamp);
```

Typing the name of the filter reiterates the information from the dialog box.

```
dee
```

```
dee =
    digitalFilter with properties:
        Coefficients: [1x11 double]
        Specifications:
            FrequencyResponse: 'lowpass'
            ImpulseResponse: 'fir'
            SampleRate: 2000
            FilterOrder: 10
            CutoffFrequency: 650
            DesignMethod: 'window'
        Use fvtool to visualize filter
        Use filter function to filter data
```

You invoke `fvtool` and get a plot of `dee`'s frequency response.

```
fvtool(dee)
```

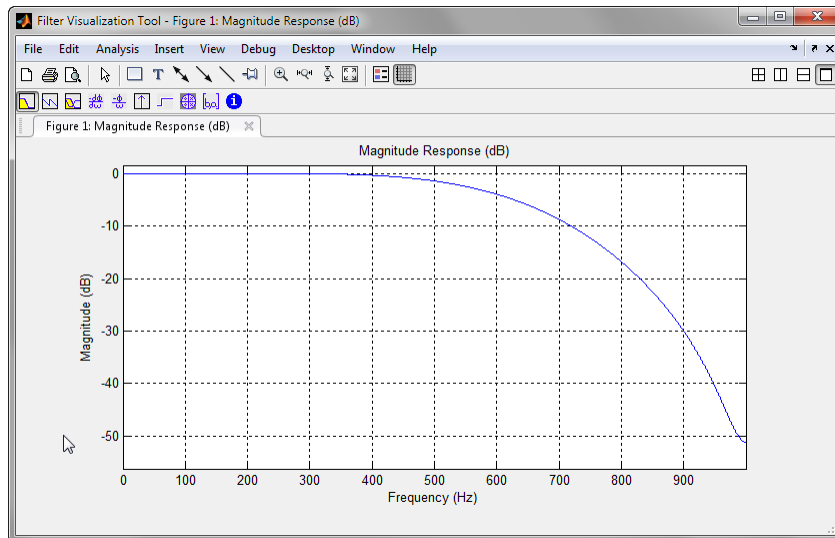

The cutoff does not look particularly sharp. The response is above 40 dB for most frequencies. You remember that the assistant had an option to set up a “magnitude constraint” called the “stopband attenuation”. Open the assistant by calling `designfilt` with the filter name as input.

```
designfilt(dee)
```

Click the **Magnitude constraints** drop-down menu and select **Passband ripple and stopband attenuation**. You see that the design method has changed from **Window** to **FIR constrained least-squares**. The default value for the attenuation is 60 dB, which is higher than 40. Click **OK** and visualize the resulting filter.

```
dee = designfilt('lowpassfir', 'FilterOrder', 10, ...
                'CutoffFrequency', Fctff, ...
                'PassbandRipple', 1, 'StopbandAttenuation', 60, ...
                'SampleRate', Fsamp);
```

```
fvtool(dee)
```

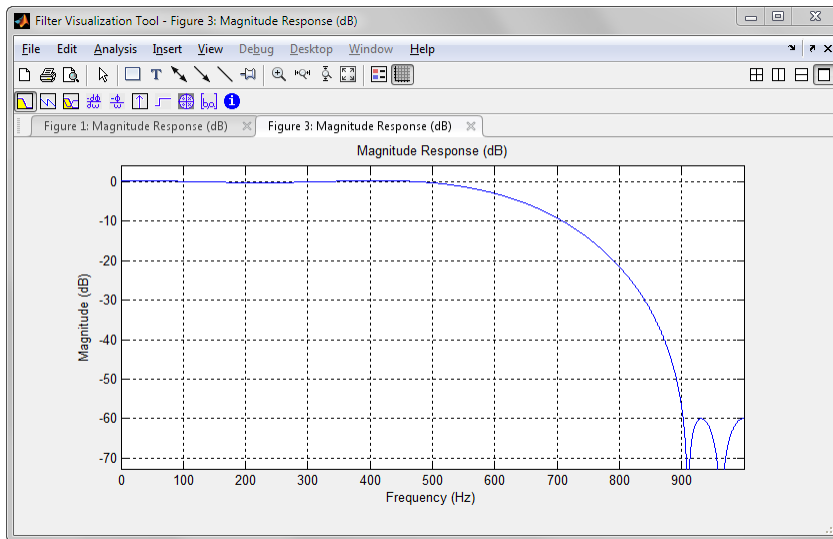

The cutoff still does not look sharp. The attenuation is indeed 60 dB, but for frequencies above 900 Hz.

Again invoke `designfilt` with your filter as input.

```
designfilt(dee)
```

The assistant reappears.

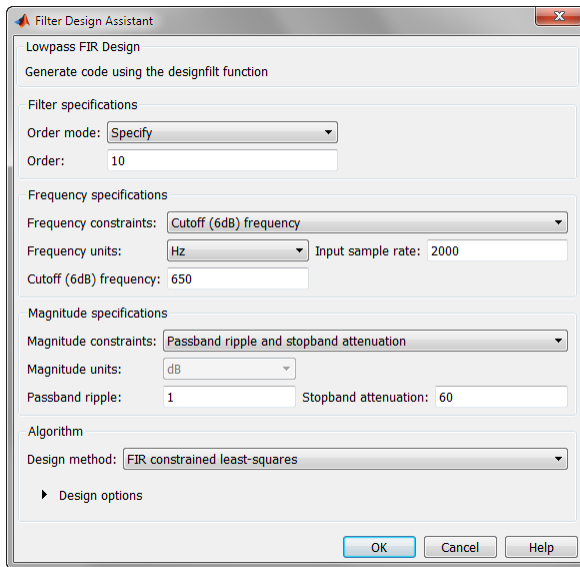

To narrow the distinction between accepted and rejected frequencies, increase the order of the filter or change **Frequency constraints** from **Cutoff (6dB) frequency** to **Passband and stopband frequencies**. If you change the filter order from 10 to 50, you get a sharper filter.

```
dee = designfilt('lowpassfir', 'FilterOrder', 50, ...
                'CutoffFrequency', 650, ...
                'PassbandRipple', 1, 'StopbandAttenuation', 60, ...
                'SampleRate', 2000);
fvtool(dee)
```

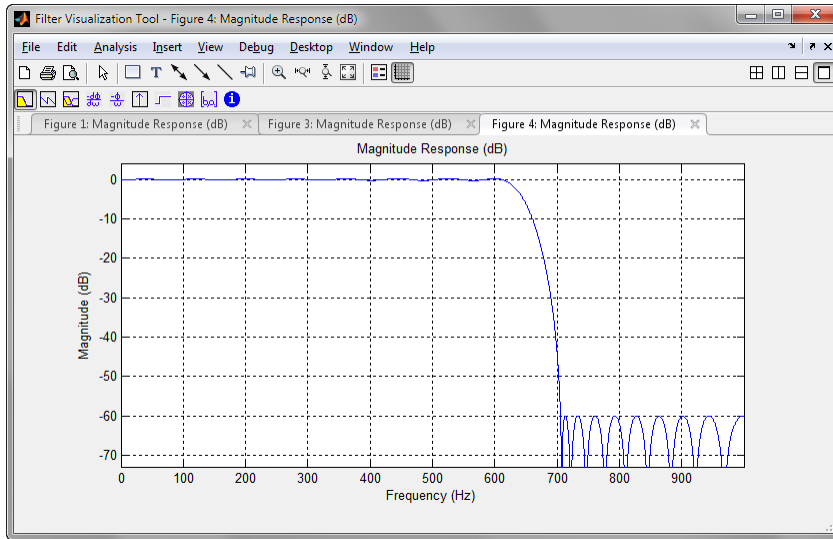

A little experimentation shows that you can obtain a similar filter by setting the passband and stopband frequencies respectively to 600 Hz and 700 Hz.

```
dee = designfilt('lowpassfir', 'PassbandFrequency', 600, ...
                'StopbandFrequency', 700, ...
                'PassbandRipple', 1, 'StopbandAttenuation', 60, ...
                'SampleRate', 2000);
fvtool(dee)
```

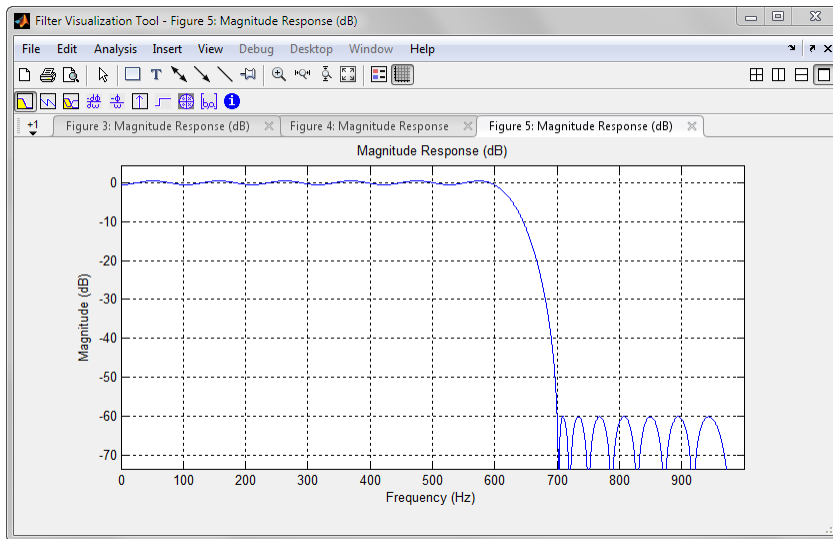
Filter Design Assistant in a Script or Function

You are given a signal sampled at 2 kHz. You are asked to design a highpass filter that stops frequencies below 700 Hz. You don't care about the phase of the signal, and you need to work with a low-order filter. Thus an IIR filter seems adequate. You are not sure what filter order is best, so you write a function that accepts the order as input. Open the MATLAB Editor and create the file.

```
function dataOut = hipassfilt(N,dataIn)
hpFilter = designfilt('highpassiir','FilterOrder',N);
dataOut = filter(hpFilter,dataIn);
end
```

To test your function, create a signal composed of two sinusoids with frequencies 500 and 800 Hz and generate samples for 0.1 s. A 5th-order filter seems reasonable as an initial guess. Create a script called `driveHPfilt.m`.

```
% script driveHPfilt.m
Fsamp = 2e3;
Fsm = 500;
Fbg = 800;
t = 0:1/Fsamp:0.1;
sgin = sin(2*pi*Fsm*t)+sin(2*pi*Fbg*t);
Order = 5;
```

```
sgout = hipassfilt(Order,sgin);
```

When you run the script at the command line, you get an error message.

```
>> driveHPfilt
Error using designfilt (line 457)
```

[Click here](#) to launch an assistant that can correct your code.

```
You have specified too few parameters for 'highpassiir'.
The following are valid parameter sets that are close to your inputs:
- FilterOrder, HalfPowerFrequency
- FilterOrder, PassbandFrequency, PassbandRipple
- FilterOrder, PassbandFrequency, StopbandAttenuation, PassbandRipple
- FilterOrder, StopbandFrequency, StopbandAttenuation
```

```
Error in hipassfilt (line 2)
hpFilter = designfilt('highpassiir','FilterOrder',N);
Error in driveHPfilt (line 7)
sgout = hipassfilt(Order,sgin);
```

The error message gives you the choice of opening an assistant to correct the MATLAB code. Click [Click here](#) to get the Filter Design Assistant on your screen.

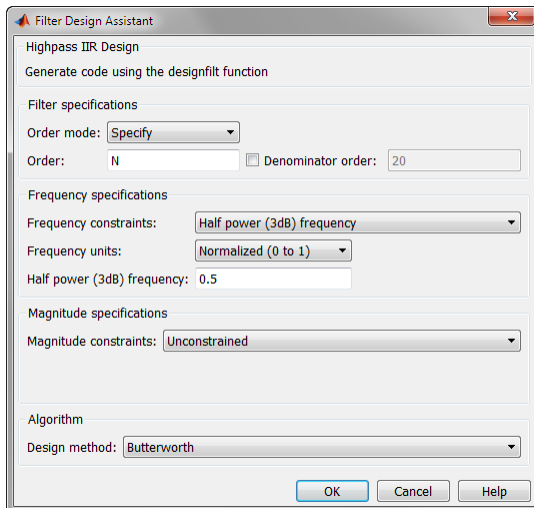

You see the problem: You did not specify the frequency constraint. You also forgot to set a sample rate. After experimenting, you find that you can specify **Frequency units** as Hz, **Passband frequency** equal to 700 Hz, and **Input Fs** equal to 2000 Hz. The **Design method** changes from Butterworth to Chebyshev type I. You click **OK** and get the following.

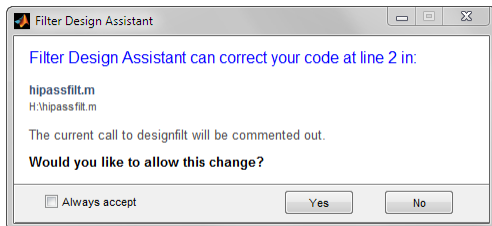

The assistant has correctly identified the file where you call `designfilt`. Click **Yes** to accept the change. The function has the corrected MATLAB code.

```
function dataOut = hipassfilt(N,dataIn)
% hpFilter = designfilt('highpassiir','FilterOrder',N);
hpFilter = designfilt('highpassiir', 'FilterOrder', N, ...
    'PassbandFrequency', 700, 'PassbandRipple', 1, ...
    'SampleRate', 2000);
dataOut = filter(hpFilter,dataIn);
end
```

You can now run the script with different values of the filter order. Depending on your design constraints, you can change your specification set.

Filter Design Assistant Preferences

You can set `designfilt` to never offer the Filter Design Assistant. This action sets a MATLAB preference that can be unset with `setpref`:

- Use `setpref('dontshowmeagain','filterDesignAssistant',false)` to be offered the assistant every time. With this command, you can get the assistant again after having disabled it.
- Use `setpref('dontshowmeagain','filterDesignAssistant',true)` to disable the assistant permanently. You can also click **Do not show this message again** in the initial dialog box.

You can set `designfilt` to always correct faulty specifications without asking. This action sets a MATLAB preference that can be unset by using `setpref`:

- Use `setpref('dontshowmeagain','filterDesignAssistantCodeCorrection',false)` to have `designfilt` correct your MATLAB code without asking for confirmation. You can also click **Always accept** in the confirmation dialog box.
- Use `setpref('dontshowmeagain','filterDesignAssistantCodeCorrection',true)` to ensure that `designfilt` corrects your MATLAB code only when you confirm you want the changes. With this command, you can undo the effect of having clicked **Always accept** in the confirmation dialog box.

Troubleshooting

There are some instances in which, given an invalid set of specifications, `designfilt` does not offer a Filter Design Assistant, either through a dialog box or through a link in an error message.

- You are not offered an assistant if you use code-section evaluation, either from the MATLAB Toolstrip or by pressing **Ctrl+Enter**. (See “Divide Your File into Code Sections” (MATLAB) for more information.)
- You are not offered an assistant if your code has multiple calls to `designfilt`, at least one of those calls is incorrect, and
 - You paste the code on the command line and execute it by pressing **Enter**.
 - You select the code in the Editor and execute it by pressing **F9**.
- You are not offered an assistant if you run `designfilt` using an anonymous function. (See “Anonymous Functions” (MATLAB) for more information.) For example, this input offers an assistant.

```
d = designfilt('lowpassfir','CutoffFrequency',0.6)
```

This input does not.

```
myFilterDesigner = @designfilt;
```

```
d = myFilterDesigner('lowpassfir','CutoffFrequency',0.6)
```

- You are not offered an assistant if you run `designfilt` using `eval`. For example, this input offers an assistant.

```
d = designfilt('lowpassfir','CutoffFrequency',0.6)
```

This input does not.

```
myFilterDesigner = ...
```

```
    sprintf('designfilt('%s','CutoffFrequency',%f)', ...  
           'lowpassfir',0.6);  
d = eval(myFilterDesigner)
```

The Filter Design Assistant requires Java[®] software and the MATLAB desktop to run. It is not supported if you run MATLAB with the `-nojvm`, `-nodisplay`, or `-nodesktop` options.

See Also

See Also

`digitalFilter` | `double` | `fftfilt` | `filt2block` | `filter` | `filtfilt` | `filtord` | `firtype` | `freqz` | `fvtool` | `grpdelay` | `impz` | `impzlength` | `info` | `isallpass` | `isdouble` | `isfir` | `islinphase` | `ismaxphase` | `isminphase` | `issingle` | `isstable` | `phasedelay` | `phasez` | `single` | `ss` | `stepz` | `tf` | `zerophase` | `zpk` | `zplane`

Topics

“Practical Introduction to Digital Filter Design”
“Filter Design Gallery”
“Practical Introduction to Digital Filtering”

Introduced in R2014a

designmethods

Methods available for designing filter from specification object

Syntax

```
M = designmethods(D)
M = designmethods(D, 'default')
M = designmethods(D, TYPE)
M = designmethods(D, 'full')
```

Description

`M = designmethods(D)` returns the available design methods for the filter specification object, `D`.

`M = designmethods(D, 'default')` returns the default design method for the filter specification object `D`.

`M = designmethods(D, TYPE)` returns the `TYPE` design methods that apply to `D`. `TYPE` can be either `'FIR'` or `'IIR'`.

`M = designmethods(D, 'full')` returns the full name for each of the available design methods. For example, `designmethods` with the `'full'` argument returns Butterworth for the `butter` method.

Examples

Valid Design Methods for Lowpass Filter

Construct a lowpass filter specification object and determine the valid design methods.

```
D = fdesign.lowpass('Fp,Fst,Ap,Ast', 500, 600, 0.5, 60, 1e4);
M = designmethods(D)

M = 8×1 cell array
    'butter'
```

```
'cheby1'  
'cheby2'  
'ellip'  
'equiripple'  
'ifir'  
'kaiserwin'  
'multistage'
```

See Also

See Also

design | designopts | fdesign

Introduced in R2009a

designopts

Valid input arguments and values for specification object and method

Syntax

```
OPTS = designopts(D,METHOD)
```

Description

`OPTS = designopts(D,METHOD)` returns a structure array with the default design parameters used by the design method `METHOD`. `METHOD` must be one of the options returned by `designmethods`.

Use `help(D,METHOD)` to get a description of the design parameters.

Examples

Butterworth Filter Design Options

Create a 10th-order lowpass filter with a 3-dB frequency of 0.2π rad/sample. Obtain the default design parameters for a Butterworth design. Test whether the filter structure is a direct-form II biquad.

```
D = fdesign.lowpass('N,F3dB',10,0.2);  
OPTS = designopts(D,'butter')
```

```
OPTS = struct with fields:  
  FilterStructure: 'df2sos'  
  SOSScaleNorm: ''  
  SOSScaleOpts: [1×1 fdopts.sosscaling]  
  SystemObject: 0
```

```
if (OPTS.FilterStructure == 'df2sos')  
  fprintf('The default filter structure is Direct-Form II\n');  
  fprintf('with second-order sections.\n');  
end
```

The default filter structure is Direct-Form II with second-order sections.

See Also

See Also

[design](#) | [designmethods](#) | [fdesign](#) | [validstructures](#)

Introduced in R2009a

dfilt

Discrete-time filter

Syntax

```
Hd = dfilt.structure(input1,...)
```

Description

`Hd = dfilt.structure(input1,...)` returns a discrete-time filter, `Hd`, of type *structure*. Each structure takes one or more inputs. If you specify a `dfilt.structure` with no inputs, a default filter is created.

Note You must use a *structure* with `dfilt`.

`Hd = [dfilt.structure(input1,...),dfilt.structure(input1,...),...]` returns a vector containing `dfilt` filters.

Structures

Available structures for the `dfilt` object are shown below. The target block for the `block` method depends on the filter structure. Depending on the target block, the DSP System Toolbox software may be required.

<code>dfilt.structure</code>	Description	Coefficient Mapping Support in <code>realizemdl</code>	Target Filter Block for <code>block</code> Method
<code>dfilt.delay</code>	Delay	Not supported	Delay Requires DSP System Toolbox
<code>dfilt.df1</code>	Direct-form I	Supported	Discrete Filter
<code>dfilt.df1sos</code>	Direct-form I, second-order sections	Supported	Discrete Filter

dfilt.structure	Description	Coefficient Mapping Support in realizemdl	Target Filter Block for block Method
			Requires DSP System Toolbox
dfilt.df1t	Direct-form I transposed	Supported	Discrete Filter
dfilt.df1tsos	Direct-form I transposed, second-order sections	Supported	Biquad Filter Requires DSP System Toolbox
dfilt.df2	Direct-form II	Supported	Discrete Filter
dfilt.df2sos	Direct-form II, second-order sections	Supported	Discrete Filter
dfilt.df2t	Direct-form II transposed	Supported	Discrete Filter
dfilt.df2tsos	Direct-form II transposed, second-order sections	Supported	Biquad Filter Requires DSP System Toolbox
dfilt.dffir	Direct-form FIR	Supported	Discrete FIR Filter
dfilt.dffirt	Direct-form FIR transposed	Supported	Discrete FIR Filter
dfilt.dfsymfir	Direct-form symmetric FIR	Supported	Discrete FIR Filter
dfilt.dfasymfir	Direct-form antisymmetric FIR	Supported	Discrete FIR Filter
dfilt.fftfir	Overlap-add FIR	Not supported	Overlap-Add FFT Filter Requires DSP System Toolbox
dfilt.latticeall	Lattice allpass	Supported	Not supported
dfilt.latticear	Lattice autoregressive (AR)	Supported	Allpole Filter Requires DSP System Toolbox

<code>dfilt.structure</code>	Description	Coefficient Mapping Support in <code>realizemdl</code>	Target Filter Block for <code>block</code> Method
<code>dfilt.latticear</code>	Lattice autoregressive moving-average (ARMA)	Supported	Not supported
<code>dfilt.latticema</code>	Lattice moving-average (MA) for maximum phase	Supported	Not supported
<code>dfilt.latticema</code>	Lattice moving-average (MA) for minimum phase	Supported	Discrete FIR Filter
<code>dfilt.statespac</code>	State-space	Supported.	Not supported
<code>dfilt.scalar</code>	Scalar gain object	Supported	Gain Requires DSP System Toolbox
<code>dfilt.cascade</code>	Filters arranged in series	Supported	Target blocks depend on filter structures in the series
<code>dfilt.parallel</code>	Filters arranged in parallel	Supported	Target blocks depend on filter structures in the parallel system

For more information on each structure, use the syntax `help dfilt.structure` at the MATLAB prompt or refer to its reference page.

Methods

Methods provide ways of performing functions directly on your `dfilt` object without having to specify the filter parameters again. You can apply these methods directly on the variable you assigned to your `dfilt` object.

For example, if you create a `dfilt` object, `Hd`, you can check whether it has linear phase with `islinphase(Hd)`, view its frequency response plot with `fvtool(Hd)`, or obtain its frequency response values with `h=freqz(Hd)`. You can use all of the methods below in this way.

Note If your variable is a 1-D array of `dfilt` filters, the method is applied to each object in the array. Only `freqz`, `grpdelay`, `impz`, `is*`, `order`, and `stepz` methods can

be applied to arrays. The `zplane` method can be applied to an array only if it is used without outputs.

Some of the methods listed below have the same name as Signal Processing Toolbox functions and they behave similarly. This is called *overloading* of functions.

Available methods are:

Method	Description
<code>addstage</code>	Adds a stage to a <code>cascade</code> or <code>parallel</code> object, where a stage is a separate, modular filter. See <code>dfilt.cascade</code> and <code>dfilt.parallel</code> .
<code>block</code>	<p><code>block(Hd)</code> creates a Simulink filter block of the <code>dfilt</code> object. The target filter block depends on the filter structure. You must have Simulink to use this method. Additionally, the DSP System Toolbox may be required depending on the filter structure. See “Structures” on page 1-324 for a mapping between the target blocks and filter structures.</p> <p>The <code>block</code> method can specify these properties/values:</p> <p>'<code>MapCoeffstoPorts</code>' indicates whether to map the filter coefficients to constant blocks connected to the generated block. Default value is '<code>off</code>'. Setting '<code>MapCoeffstoPorts</code>' to '<code>on</code>' turns on the mapping and enables the '<code>CoeffNames</code>' property, which defines the constant block parameter names. '<code>CoeffNames</code>' is a cell array of character vectors. Default values are { '<code>Num</code>' } for Direct form FIR filters, { '<code>K</code>' } for lattice filters, { '<code>Num</code>', '<code>Den</code>' } for IIR filters, and { '<code>Num</code>', '<code>Den</code>', '<code>g</code>' } for biquad filters. Variables, defined by '<code>CoeffNames</code>', are created in the MATLAB workspace and have the same data type as the filter's '<code>Arithmetic</code>' property. Any existing variable with the same name is overwritten. Note that you can use either '<code>Link2Obj</code>' or '<code>MapCoeffstoPorts</code>', but not both simultaneously.</p> <p>'<code>InputProcessing</code>' specifies sample-based, '<code>elementsaschannels</code>', frame-based,</p>

Method	Description
	'columnsaschannels', processing, or 'inherited'. The default is frame-based processing. If you do not have the DSP System Toolbox software, explicitly set the 'InputProcessing' property to 'elementsaschannels' to avoid a runtime error. Setting 'InputProcessing' to 'inherited' targets the Digital Filter block regardless of structure.
<code>cascade</code>	Returns the series combination of two <code>dfilt</code> objects. See <code>dfilt.cascade</code> .
<code>coeffs</code>	Returns the filter coefficients in a structure containing fields that use the same property names as those in the original <code>dfilt</code> .
<code>convert</code>	Converts a <code>dfilt</code> object from one filter structure to another filter structure.
<code>fcfwrite</code>	Writes a filter coefficient ASCII file. The file can contain a single filter or a vector of objects. Default filename is <code>untitled.fcf</code> . <code>fcfwrite(Hd,filename)</code> writes to a disk file named <code>filename</code> in the current working directory. The <code>.fcf</code> extension is added automatically. <code>fcfwrite(...,fmt)</code> writes the coefficients in the format <code>fmt</code> , where <code>fmt</code> can be one of the following: 'hex' for hexadecimal 'dec' for decimal 'bin' for binary representation.
<code>fftcoeffs</code>	Returns the frequency-domain coefficients used when filtering with a <code>dfilt.fftfir</code> .

Method	Description
<code>filter</code>	<p>Performs filtering using the <code>dfilt</code> object.</p> <p><code>y = filter(Hd,x)</code> filters <code>x</code> using the <code>Hd</code> filter and returns the filtered data in <code>y</code>. See “Using Filter States” on page 1-334 for information on using initial conditions. If <code>x</code> is a matrix, each column is filtered as an independent channel. If <code>x</code> is a multidimensional array, <code>filter</code> operates on the first nonsingleton dimension.</p> <p><code>y = filter(Hd,x,dim)</code> operates along the dimension <code>dim</code>. If <code>x</code> is a vector or matrix and <code>dim</code> is 1, every column of <code>x</code> is a channel. If <code>dim</code> is 2, every row is a channel.</p>
<code>firtype</code>	Returns the type (1-4) of a linear phase FIR filter.
<code>freqz</code>	Plots the frequency response in <code>fvtool</code> . Note that unlike the <code>freqz</code> function, this <code>dfilt</code> <code>freqz</code> method has a default length of 8192.
<code>grpdelay</code>	Plots the group delay in <code>fvtool</code> .
<code>impz</code>	Plots the impulse response in <code>fvtool</code> .
<code>impzlength</code>	Returns the length of the impulse response.
<code>info</code>	Displays brief <code>dfilt</code> information, such as filter structure, length, stability, linear phase, and, when appropriate, lattice and ladder length. To display detailed information about the design method, options, etc, use <code>info(Hd, 'long')</code> . The default display is <code>'short'</code> . For multistage filters (<code>cascade</code> and <code>parallel</code>), use <code>info(Hd.Stage(x))</code> , where <code>x</code> is the stage number, to see information about that stage.
<code>isallpass</code>	Returns a logical 1 (i.e., true) if the <code>dfilt</code> object is an allpass filter or a logical 0 (i.e., false) if it is not.
<code>iscascade</code>	Returns a logical 1 if the <code>dfilt</code> object is cascaded or a logical 0 if it is not.
<code>isfir</code>	Returns a logical 1 if the <code>dfilt</code> object has finite impulse response (FIR) or a logical 0 if it does not.
<code>islinphase</code>	Returns a logical 1 if the <code>dfilt</code> object is linear phase or a logical 0 if it is not.

Method	Description
<code>ismaxphase</code>	Returns a logical 1 if the <code>dfilt</code> object is maximum-phase or a logical 0 if it is not.
<code>isminphase</code>	Returns a logical 1 if the <code>dfilt</code> object is minimum-phase or a logical 0 if it is not.
<code>isparallel</code>	Returns a logical 1 if the <code>dfilt</code> object has parallel stages or a logical 0 if it does not.
<code>isreal</code>	Returns a logical 1 if the <code>dfilt</code> object has real-valued coefficients or a logical 0 if it does not.
<code>isscalar</code>	Returns a logical 1 if the <code>dfilt</code> object is a scalar or a logical 0 if it is not scalar.
<code>issos</code>	Returns a logical 1 if the <code>dfilt</code> object has second-order sections or a logical 0 if it does not.
<code>isstable</code>	Returns a logical 1 if the <code>dfilt</code> object is stable or a logical 0 if it are not.
<code>nsections</code>	Returns the number of sections in a second-order sections filter. If a multistage filter contains stages with multiple sections, using <code>nsections</code> returns the total number of sections in all the stages (a stage with a single section returns 1).
<code>nstages</code>	Returns the number of stages of the filter, where a stage is a separate, modular filter.
<code>nstates</code>	Returns the number of states for an object.
<code>order</code>	Returns the filter order. If <code>Hd</code> is a single-stage filter, the order is given by the number of delays needed for a minimum realization of the filter. If <code>Hd</code> has multiple stages, the order is given by the number of delays needed for a minimum realization of the overall filter.
<code>parallel</code>	Returns the parallel combination of two <code>dfilt</code> filters. See <code>dfilt.parallel</code> .
<code>phasez</code>	Plots the phase response in <code>fvtool</code> .

Method	Description
realizemdl	<p>(Available only with Simulink software.)</p> <p><code>realizemdl(Hd)</code> creates a Simulink model containing a subsystem block realization of your <code>dfilt</code>.</p> <p><code>realizemdl(Hd,p1,v1,p2,v2,...)</code> creates the block using the properties <code>p1</code>, <code>p2</code>,... and values <code>v1</code>, <code>v2</code>,... specified.</p> <p>The following properties are available:</p> <p>'Blockname' specifies the name of the block. The default value is 'Filter'.</p> <p>'Destination' specifies whether to add the block to a current Simulink model, create a new model, or place the block in an existing subsystem in your model. Valid values are 'current', 'new', or the name of an existing subsystem in your model. Default value is 'current'.</p> <p>'OverwriteBlock' specifies whether to overwrite an existing block that was created by <code>realizemdl</code> or create a new block. Valid values are 'on' and 'off' and the default is 'off'. Note that only blocks created by <code>realizemdl</code> are overwritten.</p> <p>The following properties optimize the block structure. Specifying 'on' turns the optimization on and 'off' creates the block without optimization. The default for each of the following is 'on'.</p> <p>'OptimizeZeros' removes zero-gain blocks.</p> <p>'OptimizeOnes' replaces unity-gain blocks with a direct connection.</p> <p>'OptimizeNegOnes' replaces negative unity-gain blocks with a sign change at the nearest summation block.</p>

Method	Description
	'OptimizeDelayChains' replaces cascaded chains of delay block with a single integer delay block set to the appropriate delay.
removestage	Removes a stage from a cascade or parallel <code>dfilt</code> . See <code>dfilt.cascade</code> and <code>dfilt.parallel</code> .
setstage	Overwrites a stage of a cascade or parallel <code>dfilt</code> . See <code>dfilt.cascade</code> and <code>dfilt.parallel</code> .
sos	<p>Converts the <code>dfilt</code> to a second-order sections <code>dfilt</code>. If <code>Hd</code> has a single section, the returned filter has the same class.</p> <p><code>sos(Hd, flag)</code> specifies the ordering of the second-order sections. If <code>flag='UP'</code>, the first row contains the poles closest to the origin, and the last row contains the poles closest to the unit circle. If <code>flag='down'</code>, the sections are ordered in the opposite direction. The zeros are always paired with the poles closest to them.</p> <p><code>sos(Hd, flag, scale)</code> specifies the scaling of the gain and the numerator coefficients of all second-order sections. <code>scale</code> can be <code>'none'</code>, <code>'inf'</code> (infinity-norm) or <code>'two'</code> (2-norm). Using infinity-norm scaling with <code>up</code> ordering minimizes the probability of overflow in the realization. Using 2-norm scaling with <code>down</code> ordering minimizes the peak roundoff noise.</p>
ss	Converts the <code>dfilt</code> to state-space. To see the separate <code>A, B, C, D</code> matrices for the state-space model, use <code>[A, B, C, D]=ss(Hd)</code> .
stepz	<p>Plots the step response in <code>fvtool</code>.</p> <p><code>stepz(Hd, n)</code> computes the first <code>n</code> samples of the step response.</p> <p><code>stepz(Hd, n, Fs)</code> separates the time samples by $T = 1/Fs$, where <code>Fs</code> is assumed to be in Hz.</p>

Method	Description
sysobj	Converts the <code>dfilt</code> to a filter System object. See the reference page for a list of supported objects. To use this method, you must have DSP System Toolbox software installed.
tf	Converts the <code>dfilt</code> to a transfer function.
zerophase	Plots the zero-phase response in <code>fvtool</code> .
zpk	Converts the <code>dfilt</code> to zeros-pole-gain form.
zplane	Plots a pole-zero plot in <code>fvtool</code> .

For more information on each method, use the syntax `help dfilt/method` at the MATLAB prompt.

Viewing Properties

As with any object, you can use `get` to view a `dfilt` properties. To see a specific property, use

```
get(Hd, 'property')
```

To see all properties for an object, use

```
get(Hd)
```

Changing Properties

To set specific properties, use

```
set(Hd, 'property1', value, 'property2', value, ...)
```

Note that you must use single quotation marks around the property name.

Alternatively, you can get or set a property value with `Object.property`:

```
b = [0.05 0.9 0.05];
Hd = dfilt.dffir(b);
% Lowpass direct-form I FIR filter
Hd.arithmetic % get arithmetic property
% returns double
```

```
Hd.arithmetic = 'single';  
% Set arithmetic property to single precision
```

Copying an Object

To create a copy of an object, use the `copy` method.

```
H2 = copy(Hd)
```

Note Using the syntax `H2 = Hd` copies only the object handle and does not create a new object.

Converting Between Filter Structures

To change the filter structure of a `dfilt` object `Hd`, use

```
Hd2=convert(Hd, 'structure_name');
```

where `structure_name` is any valid structure name in single quotes. If `Hd` is a `cascade` or `parallel` structure, each of its stages is converted to the new structure.

Using Filter States

Two properties control the filter states:

- `states` — stores the current states of the filter. Before the filter is applied, the states correspond to the initial conditions and after the filter is applied, the states correspond to the final conditions. For `df1`, `df1t`, `df1sos` and `df1tsos` structures, `states` returns a `filtstate` object.
- `PersistentMemory` — controls whether filter `states` are saved. The default value is `'false'`, which causes the initial conditions to be reset to zero before filtering and turns off the display of `states` information. Setting `PersistentMemory` to `'true'` allows the filter to use your initial conditions or to reuse the final conditions of a previous filtering operation as the initial conditions of the next filtering operation. It also displays information about the filter `states`.

Note If you set `states` and want to use them for filtering, you must set `PersistentMemory` to `'true'` before you use the filter.

Examples

Create a direct-form I filter and use a method to see if it is stable.

```
[b,a] = butter(8,0.25);  
Hd = dfilt.df1(b,a)
```

If a `dfilt`'s numerator values do not fit on a single line, a description of the vector is displayed. To see the specific numerator values for this example, use

```
get(Hd, 'numerator')
```

or alternatively

```
Hd.numerator
```

Refer to the reference pages for each structure for more examples.

See Also

```
dfilt.cascade | dfilt.df1 | dfilt.df1t | dfilt.df2 | dfilt.df2t  
| dfilt.dfasymfir | dfilt.dffir | dfilt.dffirt | dfilt.dfsymfir  
| dfilt.latticeallpass | dfilt.latticear | dfilt.latticearma  
| dfilt.latticemamax | dfilt.latticemamin | dfilt.parallel |  
dfilt.statespace | filter | freqz | grpdelay | impz | step | tf | zpk |  
zplane
```

Introduced before R2006a

dfilt.cascade

Cascade of discrete-time filters

Syntax

```
Hd = dfilt.cascade(Hd1,Hd2,...)
```

Description

`Hd = dfilt.cascade(Hd1,Hd2,...)` returns a discrete-time filter, `Hd`, of type `cascade`, which is a serial interconnection of two or more `dfilt` filters, `Hd1`, `Hd2`, etc. Each filter in a cascade is a separate stage.

To add a filter (`Hd1`) to the end of an existing cascade (`Hd`), use

```
addstage(Hd,Hd1)
```

and to reorder the filters in a cascade, use the stage indices to indicate the desired ordering, such as.

```
Hd.stage = Hd.stage([1,3,2]);
```

You can also use the nondot notation format for calling a cascade:

```
cascade(Hd1,Hd2,...)
```

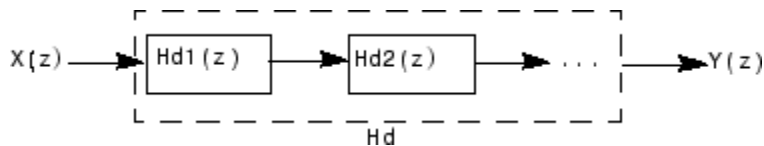

Examples

Cascade a lowpass filter and a highpass filter to produce a bandpass filter:

```
[b1,a1]=butter(8,0.6);           % Lowpass
```

```
[b2,a2]=butter(8,0.4,'high'); % Highpass
H1=dfilt.df2t(b1,a1);
H2=dfilt.df2t(b2,a2);
Hcas=dfilt.cascade(H1,H2)      % Bandpass-passband .4-.6
```

To view details of the first stage, use

```
info(Hcas.Stage(1))
```

To view the states of a stage, use

```
Hcas.stage(1).states
```

You can display states for individual stages only.

See Also

[dfilt](#) | [dfilt.parallel](#) | [dfilt.scalar](#)

Introduced before R2006a

dfilt.delay

Delay filter

Syntax

```
Hd = dfilt.delay
Hd = dfilt.delay(latency)
```

Description

`Hd = dfilt.delay` returns a discrete-time filter, `Hd`, of type `delay`, which adds a single delay to any signal filtered with `Hd`. The filtered signal has its values shifted by one sample.

`Hd = dfilt.delay(latency)` returns a discrete-time filter, `Hd`, of type `delay`, which adds the number of delay units specified in `latency` to any signal filtered with `Hd`. The filtered signal has its values shifted by the `latency` number of samples. The values that appear before the shifted signal are the filter states.

Examples

Create a delay filter with a latency of 4 and filter a simple signal to view the impact of applying a delay.

```
h = dfilt.delay(4)
h =
    FilterStructure: 'Delay'
           Latency: 4
 PersistentMemory: false

sig = 1:7      % Create some simple signal data
sig =
     1     2     3     4     5     6     7

states = h.states    % Filter states before filtering
states =
```



```
0
0
0
0

filter(h,sig)      % Filter using the delay filter
ans =
    0     0     0     0     1     2     3

states=h.states    % Filter states after filtering
states =
    4
    5
    6
    7
```

See Also

dfilt

Introduced before R2006a

dfilt.df1

Discrete-time, direct-form I filter

Syntax

```
Hd = dfilt.df1(b,a)  
Hd = dfilt.df1
```

Description

`Hd = dfilt.df1(b,a)` returns a discrete-time, direct-form I filter, `Hd`, with numerator coefficients `b` and denominator coefficients `a`. The filter states for this object are stored in a `filtstates` object.

`Hd = dfilt.df1` returns a default, discrete-time, direct-form I filter, `Hd`, with `b=1` and `a=1`. This filter passes the input through to the output unchanged.

Note The leading coefficient of the denominator `a(1)` cannot be 0.

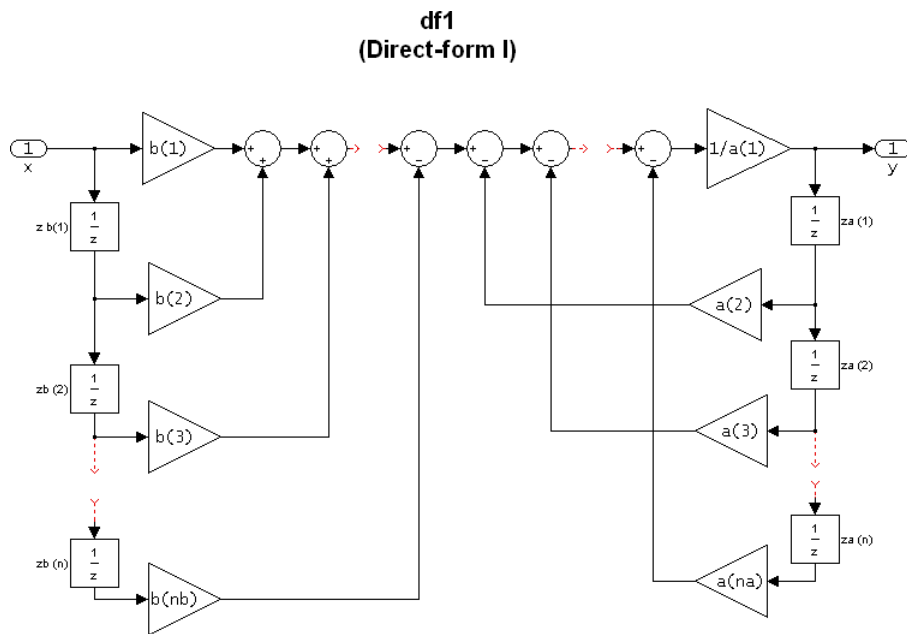

Image of direct form one filter diagram

To display the filter states, use this code to access the `filtstates` object.

```
Hs = Hd.states      % Where Hd is the dfilt.df1 object and
double (Hs)        % Hs is the filtstates object
```

The vector is

$$\begin{bmatrix} zb(1) \\ zb(2) \\ \dots \\ zb(n) \\ za(1) \\ za(2) \\ \dots \\ za(n) \end{bmatrix}$$

Examples

Create a direct-form I discrete-time filter with coefficients from a fourth-order lowpass Butterworth design

```
[b,a] = butter(4,.5);  
Hd = dfilt.df1(b,a)
```

See Also

[dfilt](#) | [dfilt.df1t](#) | [dfilt.df2](#) | [dfilt.df2t](#)

Introduced before R2006a

dfilt.df1sos

Discrete-time, second-order section, direct-form I filter

Syntax

```
Hd = dfilt.df1sos(s)
Hd = dfilt.df1sos(b1,a1,b2,a2,...)
Hd = dfilt.df1sos(...,g)
Hd = dfilt.df1sos
```

Description

`Hd = dfilt.df1sos(s)` returns a discrete-time, second-order section, direct-form I filter, `Hd`, with coefficients given in the `s` matrix. The filter states for this object are stored in a `filtstates` object.

`Hd = dfilt.df1sos(b1,a1,b2,a2,...)` returns a discrete-time, second-order section, direct-form I filter, `Hd`, with coefficients for the first section given in the `b1` and `a1` vectors, for the second section given in the `b2` and `a2` vectors, etc.

`Hd = dfilt.df1sos(...,g)` includes a gain vector `g`. The elements of `g` are the gains for each section. The maximum length of `g` is the number of sections plus one. If `g` is not specified, all gains default to one.

`Hd = dfilt.df1sos` returns a default, discrete-time, second-order section, direct-form I filter, `Hd`. This filter passes the input through to the output unchanged.

Note The leading coefficient of the denominator `a(1)` cannot be 0.

df1sos
(Direct-form I, second-order sections)

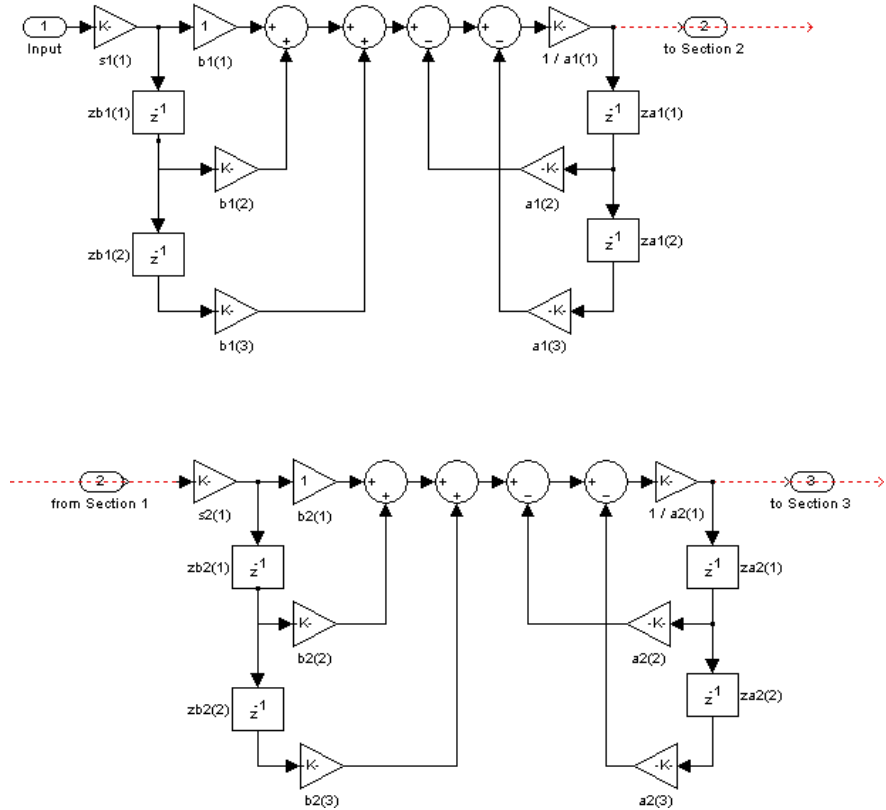

To display the filter states, use this code to access the `filtstates` object.

```
Hs = Hd.states      % Where Hd is the dfilter.df1 object and
double (Hs)        % Hs is the filtstates object
```

The vector is

$$\begin{pmatrix} zb1(1) & zb2(1) \\ zb1(2) & zb2(2) \\ za1(1) & za2(1) \\ za1(2) & za2(2) \end{pmatrix}$$

For filters with more than one section, each section is a separate column in the matrix.

Examples

Specify a second-order sections, direct-form I discrete-time filter with coefficients from a sixth order, lowpass, elliptical filter using the following code. The resulting filter has three sections.

```
[z,p,k] = ellip(6,1,60,.4); % Obtain filter coefficients
[s,g] = zp2sos(z,p,k);      % Convert to SOS
Hd = dfilt.df1sos(s,g)
```

See Also

dfilt | dfilt.df1tsos | dfilt.df2sos | dfilt.df2tsos

Introduced before R2006a

dfilt.df1t

Discrete-time, direct-form I transposed filter

Syntax

`Hd = dfilt.df1t(b,a)`
`Hd = dfilt.df1t`

Description

`Hd = dfilt.df1t(b,a)` returns a discrete-time, direct-form I transposed filter, `Hd`, with numerator coefficients `b` and denominator coefficients `a`. The filter states for this object are stored in a `filtstates` object.

`Hd = dfilt.df1t` returns a default, discrete-time, direct-form I transposed filter, `Hd`, with `b=1` and `a=1`. This filter passes the input through to the output unchanged.

Note The leading coefficient of the denominator `a(1)` cannot be 0.

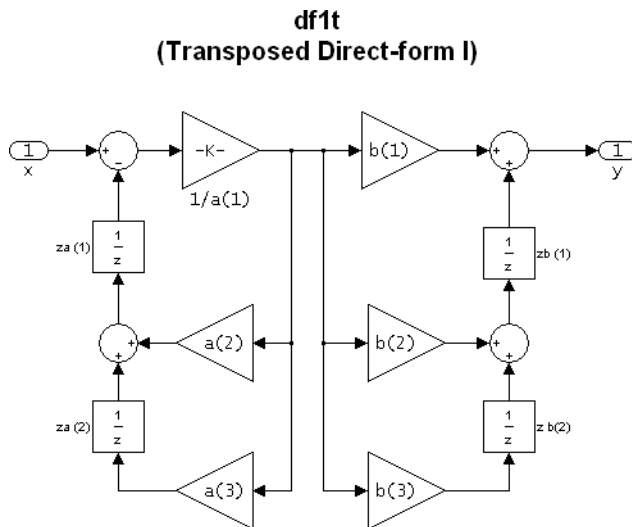

To display the filter states, use this code to access the `filtstates` object.

```
Hs = Hd.states      % Where Hd is the dfilt.df1 object and
double (Hs)        % Hs is the filtstates object
```

The vector of states is:

$$\begin{pmatrix} zb(1) \\ zb(2) \\ \vdots \\ zb(M) \\ za(1) \\ za(2) \\ \vdots \\ za(N) \end{pmatrix}$$

Alternatively, you can access the states in the `filtstates` object:

```
b = [0.05 0.9 0.05];
Hd = dfilt.df1t(b,1);
Hd.States
% Returns
% Numerator: [2x1 double]
% Denominator: [0x1 double]
Hd.States.Numerator(1)=1; %Set zb(1) equal to 1.
```

Examples

Create a direct-form I transposed discrete-time filter with coefficients from a fourth-order lowpass Butterworth design:

```
[b,a] = butter(4,.5);
Hd = dfilt.df1t(b,a)
```

See Also

[dfilt](#) | [dfilt.df1](#) | [dfilt.df2](#) | [dfilt.df2t](#)

Introduced before R2006a

dfilt.df1tsos

Discrete-time, second-order section, direct-form I transposed filter

Syntax

```
Hd = dfilt.df1tsos(s)
Hd = dfilt.df1tsos(b1,a1,b2,a2,...)
Hd = dfilt.df1tsos(...,g)
Hd = dfilt.df1tsos
```

Description

`Hd = dfilt.df1tsos(s)` returns a discrete-time, second-order section, direct-form I, transposed filter, `Hd`, with coefficients given in the `s` matrix. The filter states for this object are stored in a `filtstates` object.

`Hd = dfilt.df1tsos(b1,a1,b2,a2,...)` returns a discrete-time, second-order section, direct-form I, transposed filter, `Hd`, with coefficients for the first section given in the `b1` and `a1` vectors, for the second section given in the `b2` and `a2` vectors, etc.

`Hd = dfilt.df1tsos(...,g)` includes a gain vector `g`. The elements of `g` are the gains for each section. The maximum length of `g` is the number of sections plus one. If `g` is not specified, all gains default to one.

`Hd = dfilt.df1tsos` returns a default, discrete-time, second-order section, direct-form I, transposed filter, `Hd`. This filter passes the input through to the output unchanged.

Note The leading coefficient of the denominator `a(1)` cannot be 0.

df1tsos (Transposed Direct-form I, second-order sections)

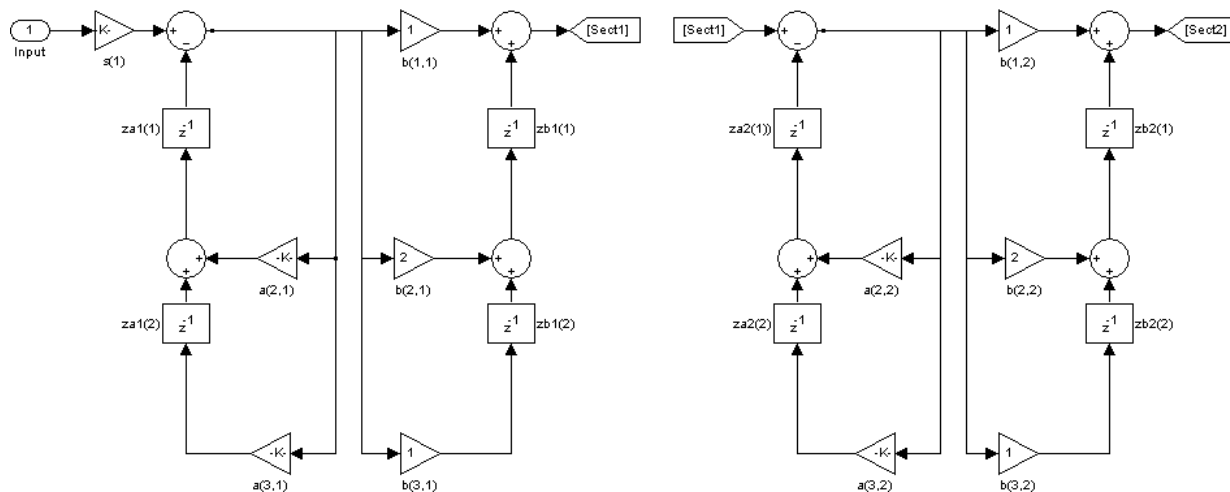

To display the filter states, use this code to access the `filtstates` object.

```
Hs = Hd.states % Where Hd is the dfilt.df1 object and
double (Hs) % Hs is the filtstates object
```

The matrix is

$$\begin{pmatrix} zb1(1) & zb2(1) \\ zb1(2) & zb2(2) \\ za1(1) & za2(1) \\ za1(2) & za2(2) \end{pmatrix}$$

Examples

Specify a second-order sections, direct-form I, transposed discrete-time filter with coefficients from a sixth order, lowpass, elliptical filter using the following code:

```
[z,p,k] = ellip(6,1,60,.4); % Obtain filter coefficients
[s,g] = zp2sos(z,p,k); % Convert to SOS
```

```
Hd = dfilt.df1tsos(s,g)
```

See Also

`dfilt` | `dfilt.df1sos` | `dfilt.df2sos` | `dfilt.df2tsos`

Introduced before R2006a

dfilt.df2

Discrete-time, direct-form II filter

Syntax

`Hd = dfilt.df2(b,a)`

`Hd = dfilt.df2`

Description

`Hd = dfilt.df2(b,a)` returns a discrete-time, direct-form II filter, `Hd`, with numerator coefficients `b` and denominator coefficients `a`.

`Hd = dfilt.df2` returns a default, discrete-time, direct-form II filter, `Hd`, with `b=1` and `a=1`. This filter passes the input through to the output unchanged.

Note The leading coefficient of the denominator `a(1)` cannot be 0.

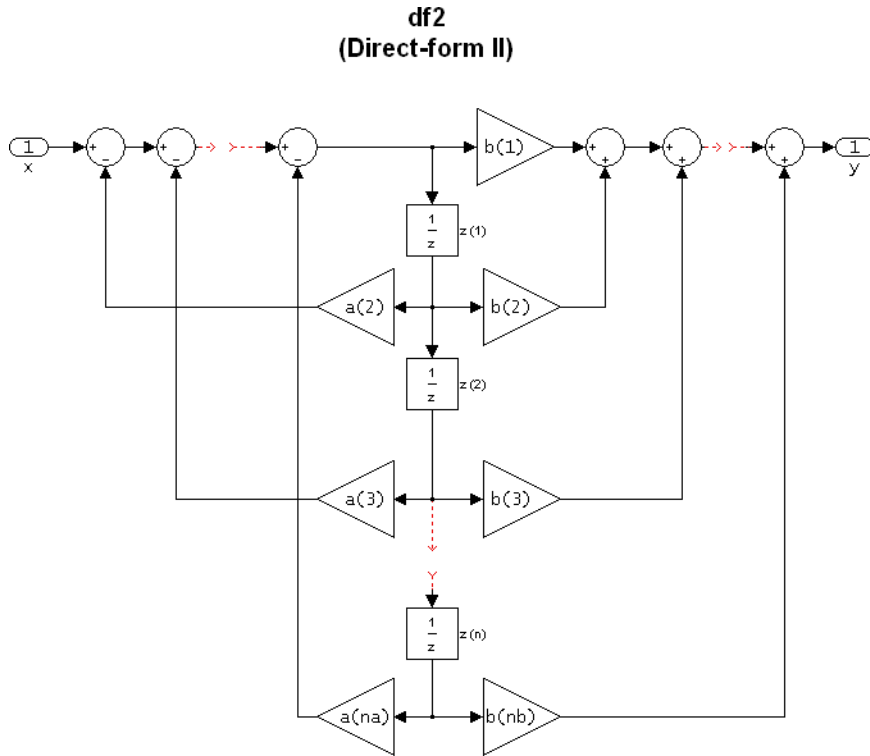

The resulting filter states column vector is

$$\begin{bmatrix} z(1) \\ z(2) \\ \vdots \\ z(n) \end{bmatrix}$$

Examples

Create a direct-form II discrete-time filter with coefficients from a fourth-order lowpass Butterworth design:

```
[b,a] = butter(4,.5);
```

```
Hd = dfilt.df2(b,a)
```

See Also

`dfilt` | `dfilt.df1` | `dfilt.df1t` | `dfilt.df2t`

Introduced before R2006a

dfilt.df2sos

Discrete-time, second-order section, direct-form II filter

Syntax

```
Hd = dfilt.df2sos(s)
Hd = dfilt.df2sos(b1,a1,b2,a2,...)
Hd = dfilt.df2sos(...,g)
Hd = dfilt.df2sos
```

Description

`Hd = dfilt.df2sos(s)` returns a discrete-time, second-order section, direct-form II filter, `Hd`, with coefficients given in the `s` matrix.

`Hd = dfilt.df2sos(b1,a1,b2,a2,...)` returns a discrete-time, second-order section, direct-form II object, `Hd`, with coefficients for the first section given in the `b1` and `a1` vectors, for the second section given in the `b2` and `a2` vectors, etc.

`Hd = dfilt.df2sos(...,g)` includes a gain vector `g`. The elements of `g` are the gains for each section. The maximum length of `g` is the number of sections plus one. If `g` is not specified, all gains default to one.

`Hd = dfilt.df2sos` returns a default, discrete-time, second-order section, direct-form II filter, `Hd`. This filter passes the input through to the output unchanged.

Note The leading coefficient of the denominator `a(1)` cannot be 0.

df2sos
(Direct-form II, second-order sections)

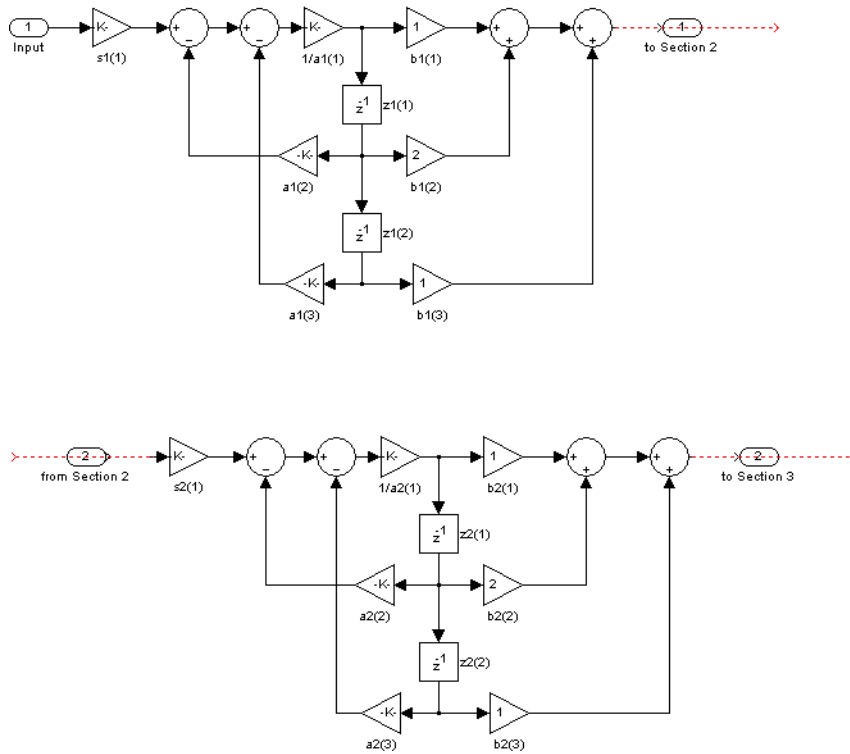

The resulting filter states column vector is

$$\begin{pmatrix} z1(1) & z2(1) \\ z1(2) & z2(2) \end{pmatrix}$$

For filters with more than one section, each section is a separate column in the vector.

Examples

Specify a second-order sections, direct-form II discrete-time filter with coefficients from a sixth order, lowpass, elliptical filter using the following code:

```
[z,p,k] = ellip(6,1,60,.4); % Obtain filter coefficients  
[s,g] = zp2sos(z,p,k); % Convert to SOS  
Hd = dfilt.df2sos(s,g)
```

See Also

[dfilt](#) | [dfilt.df1sos](#) | [dfilt.df1tsos](#) | [dfilt.df2tsos](#)

Introduced before R2006a

dfilt.df2t

Discrete-time, direct-form II transposed filter

Syntax

```
Hd = dfilt.df2t(b,a)  
Hd = dfilt.df2t
```

Description

`Hd = dfilt.df2t(b,a)` returns a discrete-time, direct-form II transposed filter, `Hd`, with numerator coefficients `b` and denominator coefficients `a`.

`Hd = dfilt.df2t` returns a default, discrete-time, direct-form II transposed filter, `Hd`, with `b=1` and `a=1`. This filter passes the input through to the output unchanged.

Note The leading coefficient of the denominator `a(1)` cannot be 0.

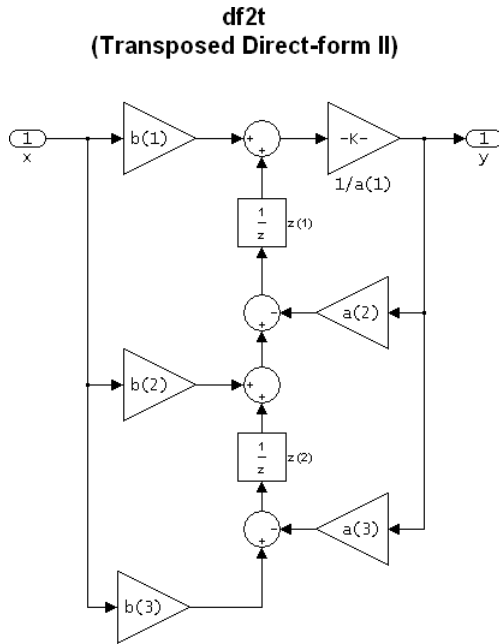

The filter states of `dfilt.df2t` object can be extracted as a column vector with:

```
b = [1 2];
a = [1 -0.9];
Hd = dfilt.df2t(b,a);
FiltStates = double(Hd.States);
```

The resulting filter states column vector is

$$\begin{pmatrix} z(1) \\ z(2) \end{pmatrix}$$

Examples

Create a direct-form II transposed discrete-time filter with coefficients from a 4–th order lowpass Butterworth design:

```
[b,a] = butter(4,.5);
```

```
Hd = dfilt.df2t(b,a);
```

See Also

[dfilt](#) | [dfilt.df1](#) | [dfilt.df1t](#) | [dfilt.df2](#)

Introduced before R2006a

dfilt.df2tsos

Discrete-time, second-order section, direct-form II transposed filter

Syntax

```
Hd = dfilt.df2tsos(s)
Hd = dfilt.df2tsos(b1,a1,b2,a2,...)
Hd = dfilt.df2tsos(...,g)
Hd = dfilt.df2tsos
```

Description

`Hd = dfilt.df2tsos(s)` returns a discrete-time, second-order section, direct-form II, transposed filter, `Hd`, with coefficients given in the `s` matrix.

`Hd = dfilt.df2tsos(b1,a1,b2,a2,...)` returns a discrete-time, second-order section, direct-form II, transposed filter, `Hd`, with coefficients for the first section given in the `b1` and `a1` vectors, for the second section given in the `b2` and `a2` vectors, etc.

`Hd = dfilt.df2tsos(...,g)` includes a gain vector `g`. The elements of `g` are the gains for each section. The maximum length of `g` is the number of sections plus one. If `g` is not specified, all gains default to one.

`Hd = dfilt.df2tsos` returns a default, discrete-time, second-order section, direct-form II, transposed filter, `Hd`. This filter passes the input through to the output unchanged.

Note The leading coefficient of the denominator `a(1)` cannot be 0.

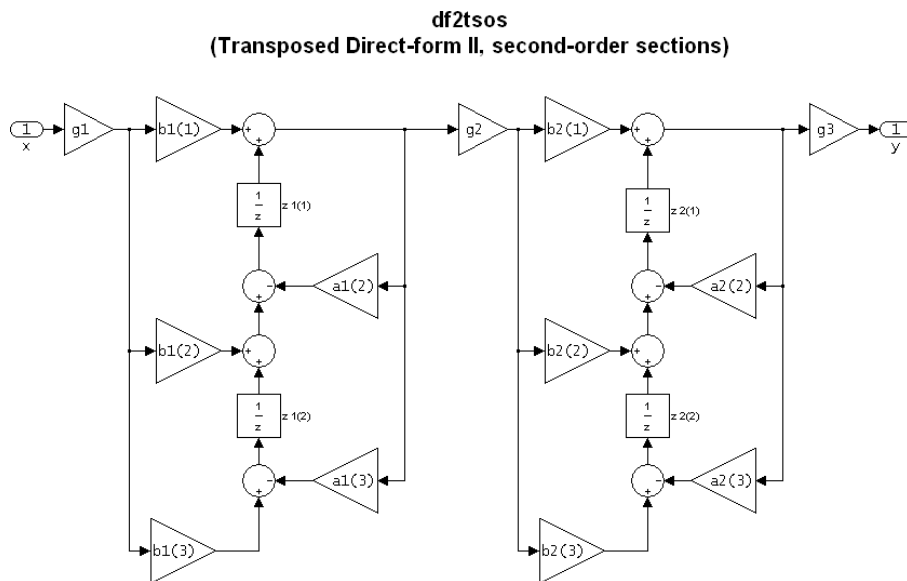

The resulting filter states column vector is

$$\begin{pmatrix} z1(1) & z2(1) \\ z1(2) & z2(2) \end{pmatrix}$$

Examples

Elliptic Filter as Second-Order Sections

Design a second-order sections, direct-form II, transposed discrete-time filter starting from a 6th-order lowpass elliptic filter. Specify a passband edge frequency of 0.4π rad/sample, a passband ripple of 1 dB, and a stopband attenuation of 60 dB. Visualize the filter response.

```
[z,p,k] = ellip(6,1,60,0.4); % Obtain filter coefficients
[s,g] = zp2sos(z,p,k); % Convert to SOS
```

```
Hd = dfilt.df2tsos(s,g);
```

`fvtool(Hd)`

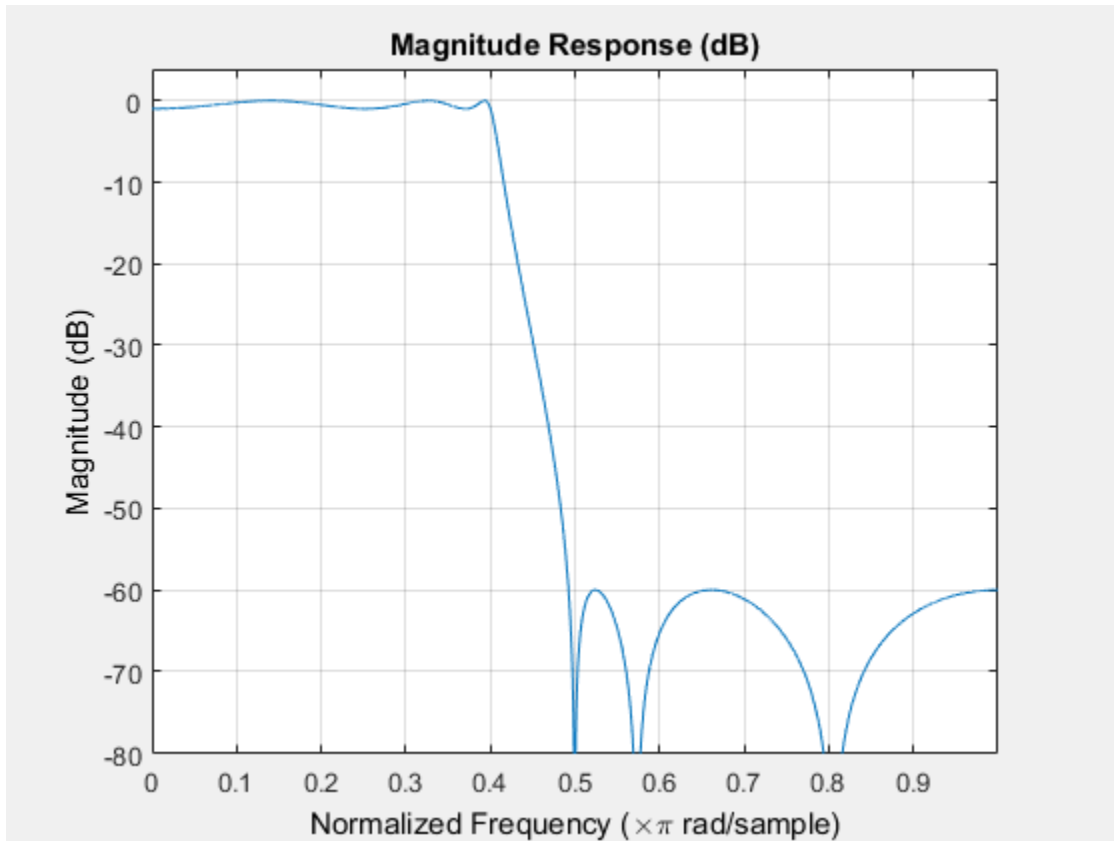

See Also

`dfilt` | `dfilt.df1sos` | `dfilt.df1tsos` | `dfilt.df2sos`

Introduced before R2006a

dfilt.dfasymfir

Discrete-time, direct-form antisymmetric FIR filter

Syntax

```
Hd = dfilt.dfasymfir(b)  
Hd = dfilt.dfasymfir
```

Description

`Hd = dfilt.dfasymfir(b)` returns a discrete-time, direct-form, antisymmetric FIR filter, `Hd`, with numerator coefficients `b`.

`Hd = dfilt.dfasymfir` returns a default, discrete-time, direct-form, antisymmetric FIR filter, `Hd`, with `b=1`. This filter passes the input through to the output unchanged.

Note Only the first half of vector `b` is used because the second half is assumed to be antisymmetric. In the figure below for an odd number of coefficients, $b(3) = 0$, $b(4) = -b(2)$ and $b(5) = -b(1)$, and in the next figure for an even number of coefficients, $b(4) = -b(3)$, $b(5) = -b(2)$, and $b(6) = -b(1)$.

dfasymfir
(Antisymmetric FIR)
Even order
Odd number of coefficients, length(b) = 7

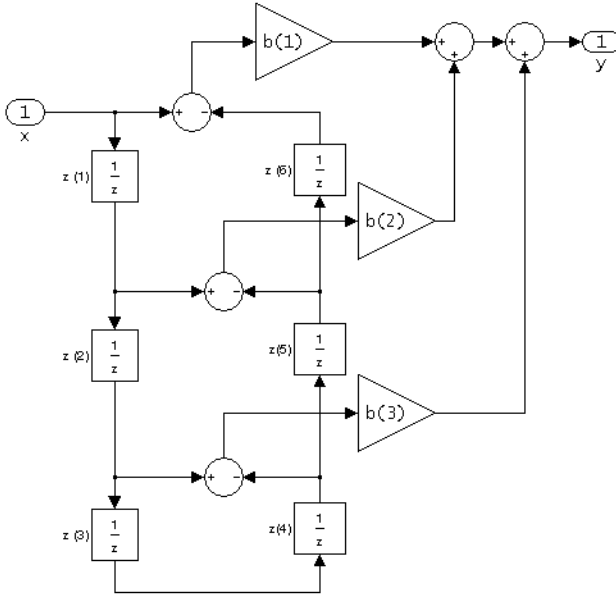

Note that antisymmetry is defined as
 $b(i) == -b(\text{end} - i + 1)$
so that the middle coefficient is zero for odd length
 $b((\text{end}+1)/2) = 0$

dfasymfir
(Antisymmetric FIR)
Even number of coefficients, length(b) = 6

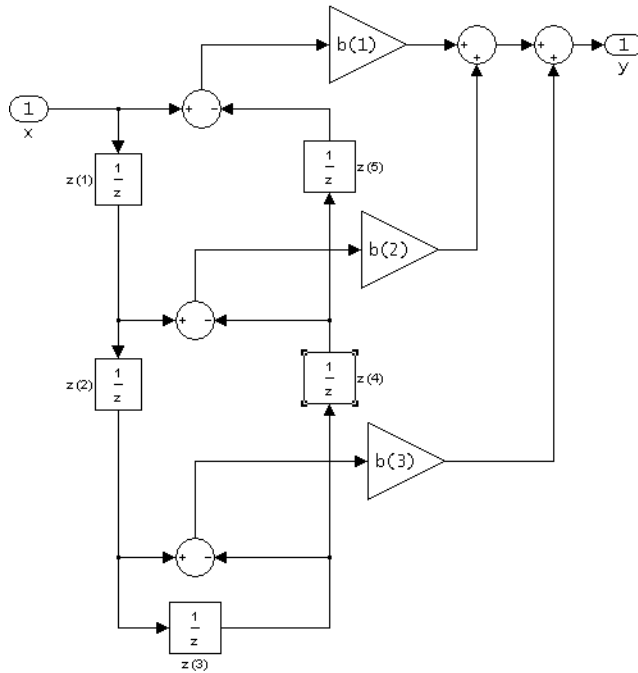

$$\mathbf{b}(i) == -\mathbf{b}(\text{end} - i + 1)$$

The resulting filter states column vector for the odd number of coefficients example above is

$$\begin{bmatrix} z(1) \\ z(2) \\ z(3) \\ z(4) \\ z(5) \\ z(6) \end{bmatrix}$$

Examples

Odd-Order Antisymmetric FIR Filter Structure

Create a Type-4 25th-order highpass direct-form antisymmetric FIR filter structure for a `dfilt` object.

```
Num_coeffs = firpm(25,[0 .4 .5 1],[0 0 1 1], 'h');  
Hd = dfilt.dfasymfir(Num_coeffs);
```

Display the impulse response of the filter.

```
impz(Hd)
```

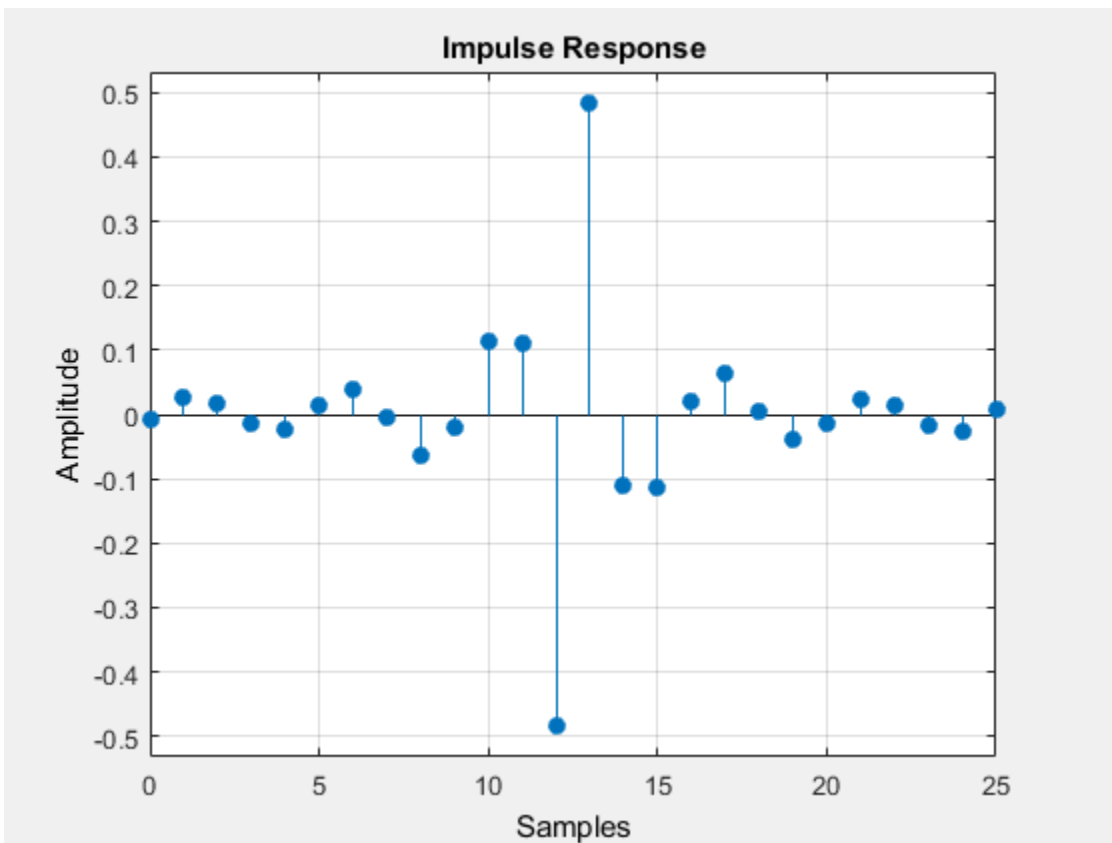

Even-Order Antisymmetric FIR Filter Structure

Create a 44th-order lowpass direct-form antisymmetric FIR differentiator filter structure for a `dfilt` object.

```
Num_coeffs = firpm(44,[0 .3 .4 1],[0 .2 0 0],'differentiator');  
Hd = dfilt.dfasymfir(Num_coeffs);
```

Display the impulse response of the filter.

```
impz(Hd)
```

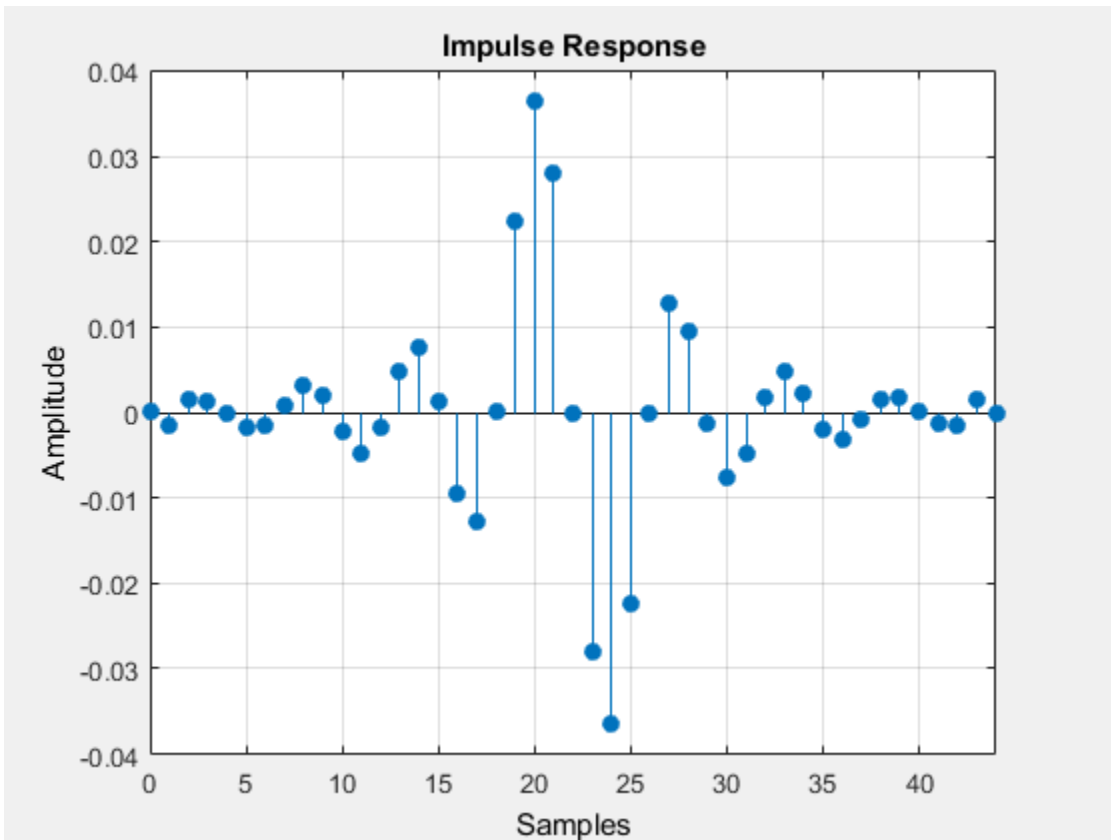

See Also

`dfilt` | `dfilt.dffir` | `dfilt.dffirt` | `dfilt.dfsymfir`

Introduced before R2006a

dfilt.dffir

Discrete-time, direct-form, FIR filter

Syntax

```
Hd = dfilt.dffir(b)
Hd = dfilt.dffir
```

Description

`Hd = dfilt.dffir(b)` returns a discrete-time, direct-form finite impulse response (FIR) filter, `Hd`, with numerator coefficients, `b`.

`Hd = dfilt.dffir` returns a default, discrete-time, direct-form FIR filter, `Hd`, with `b=1`. This filter passes the input through to the output unchanged.

dffir
(Direct-form FIR = Tapped delay line)

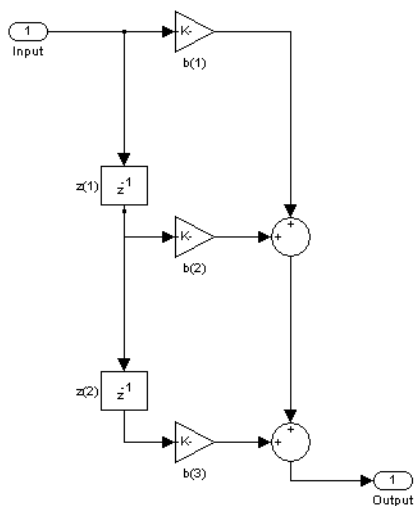

The resulting filter states column vector is

$$\begin{pmatrix} z(1) \\ z(2) \end{pmatrix}$$

Examples

Create a direct-form FIR discrete-time filter with coefficients from a 30th order lowpass equiripple design:

```
b = firpm(30,[0 .1 .2 .5]*2,[1 1 0 0]);  
Hd = dfilt.dffir(b)
```

See Also

[dfilt](#) | [dfilt.dfasymfir](#) | [dfilt.dffirt](#) | [dfilt.dfsymfir](#)

Introduced before R2006a

dfilt.dffirt

Discrete-time, direct-form FIR transposed filter

Syntax

```
Hd = dfilt.dffirt(b)
Hd = dfilt.dffirt
```

Description

`Hd = dfilt.dffirt(b)` returns a discrete-time, direct-form FIR transposed filter, `Hd`, with numerator coefficients `b`.

`Hd = dfilt.dffirt` returns a default, discrete-time, direct-form FIR transposed filter, `Hd`, with `b=1`. This filter passes the input through to the output unchanged.

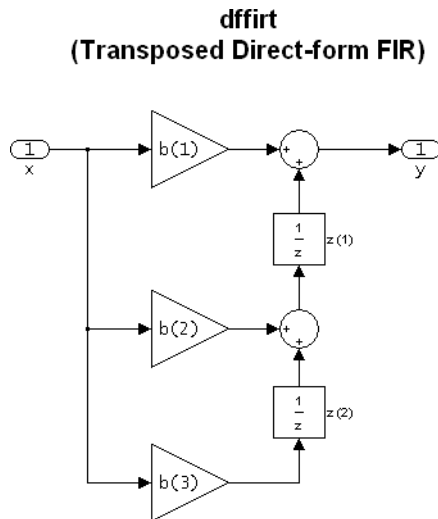

The resulting filter states column vector is

$$\begin{pmatrix} z(1) \\ z(2) \end{pmatrix}$$

Examples

Create a direct-form FIR transposed discrete-time filter with coefficients from a 30th order lowpass equiripple design:

```
b = firpm(30,[0 .1 .2 .5]*2,[1 1 0 0]);  
Hd = dfilt.dffirt(b)
```

See Also

[dfilt](#) | [dfilt.dffir](#) | [dfilt.dfasymfir](#) | [dfilt.dfsymfir](#)

Introduced before R2006a

dfilt.dfsymfir

Discrete-time, direct-form symmetric FIR filter

Syntax

```
Hd = dfilt.dfsymfir(b)  
Hd = dfilt.dfsymfir
```

Description

`Hd = dfilt.dfsymfir(b)` returns a discrete-time, direct-form symmetric FIR filter, `Hd`, with numerator coefficients `b`.

`Hd = dfilt.dfsymfir` returns a default, discrete-time, direct-form symmetric FIR filter, `Hd`, with `b=1`. This filter passes the input through to the output unchanged.

Note Only the first half of vector `b` is used because the second half is assumed to be symmetric. In the figure below for an odd number of coefficients, `b(3) = 0`, `b(4) = b(2)` and `b(5) = b(1)`, and in the next figure for an even number of coefficients, `b(4) = b(3)`, `b(5) = b(2)`, and `b(6) = b(1)`.

dfsymfir
(Symmetric FIR)
Even order
Odd number of coefficients, length(b) = 5
 $b(i) == b(\text{end} - i + 1)$

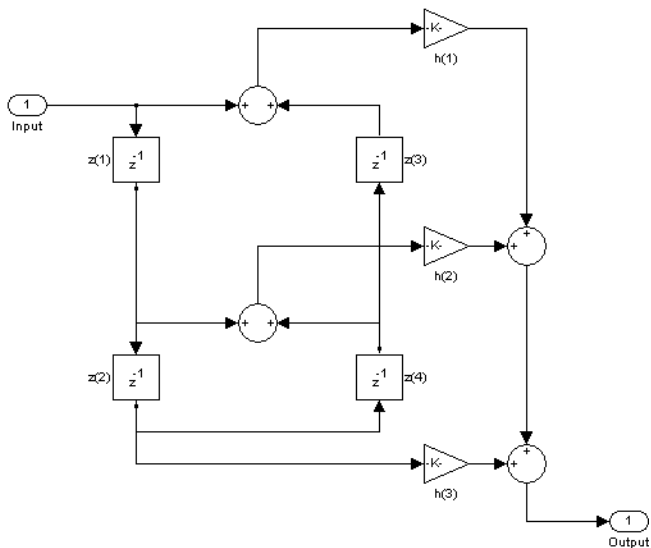

dfsymfir
(Symmetric FIR)
Odd order
Even number of coefficients, length(b) = 6
 $b(i) == b(\text{end} - i + 1)$

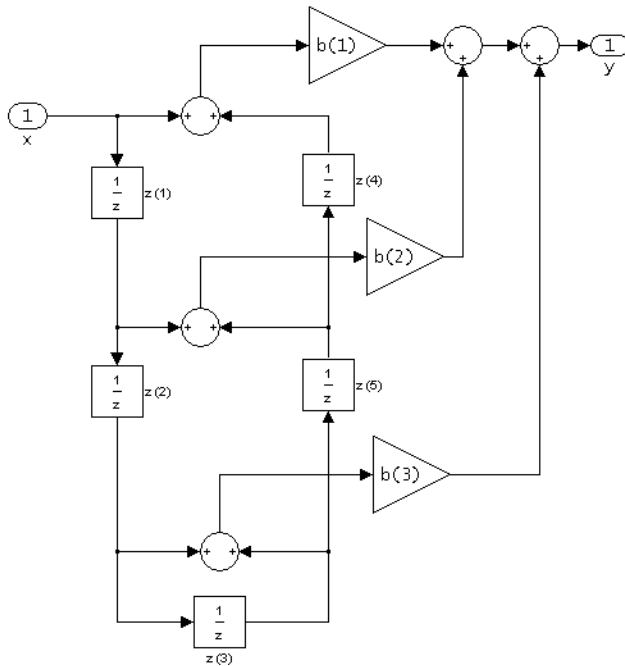

The resulting filter states column vector for the odd number of coefficients example above is

$$\begin{bmatrix} z(1) \\ z(2) \\ z(3) \\ z(4) \end{bmatrix}$$

Examples

Odd-Order Symmetric FIR Filter Structure

Create a Type-2 15th-order direct-form symmetric FIR filter structure for a `dfilt` object.

```
Num_coeffs = fir1(15,0.5);  
Hd = dfilt.dfsymfir(Num_coeffs);
```

Display the impulse response of the filter.

```
impz(Hd)
```

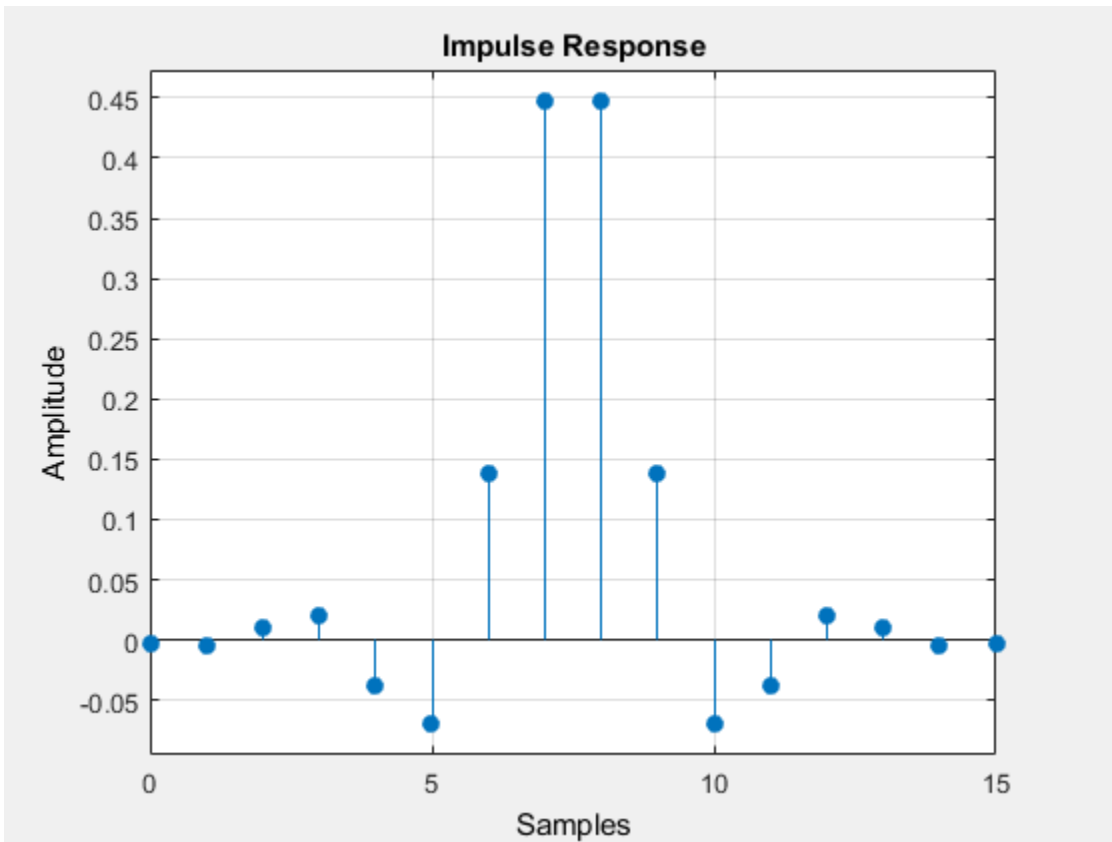

Even-Order Symmetric FIR Filter Structure

Create a Type-1 16th-order direct-form symmetric FIR filter structure for a `dfilt` object.

```
Num_coeffs = fir1(16,0.5);  
Hd = dfilt.dfsymfir(Num_coeffs);
```

Display the impulse response of the filter.

```
impz(Hd)
```

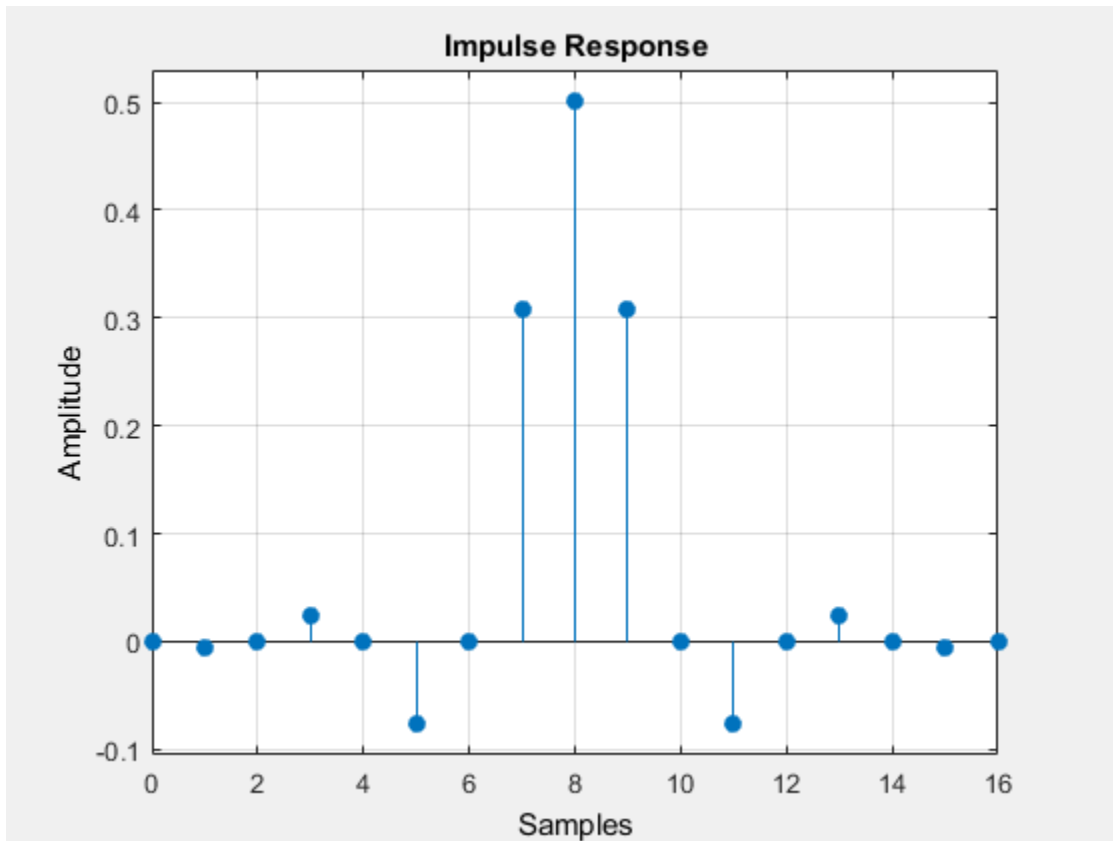

See Also

`dfilt` | `dfilt.dfasymfir` | `dfilt.dffir` | `dfilt.dffirt`

Introduced before R2006a

dfilt.fftfir

Discrete-time, overlap-add, FIR filter

Syntax

```
Hd = dfilt.fftfir(b,len)
Hd = dfilt.fftfir(b)
Hd = dfilt.fftfir
```

Description

This object uses the overlap-add method of block FIR filtering, which is very efficient for streaming data.

`Hd = dfilt.fftfir(b,len)` returns a discrete-time, FFT, FIR filter, `Hd`, with numerator coefficients, `b` and block length, `len`. The block length is the number of input points to use for each overlap-add computation.

`Hd = dfilt.fftfir(b)` returns a discrete-time, FFT, FIR filter, `Hd`, with numerator coefficients, `b` and block length, `len=100`.

`Hd = dfilt.fftfir` returns a default, discrete-time, FFT, FIR filter, `Hd`, with the numerator `b=1` and block length, `len=100`. This filter passes the input through to the output unchanged.

Note When you use a `dfilt.fftfir` object to filter data, the filter always operates on a segment of the signal equal in length to an integer multiple of the object's block length, `len`. If the input signal length is not equal to an integer multiple of the block length, the signal length is truncated to the nearest integer satisfying this requirement. If the `PersistentMemory` property is set to `true`, the next time you use the filter object the remaining signal samples are prepended to the subsequent input. The resulting number of FFT points = (filter length + the block length - 1). The filter is most efficient if the number of FFT points is a power of 2.

The `fftfir` uses an overlap-add block processing algorithm, which is represented as follows,

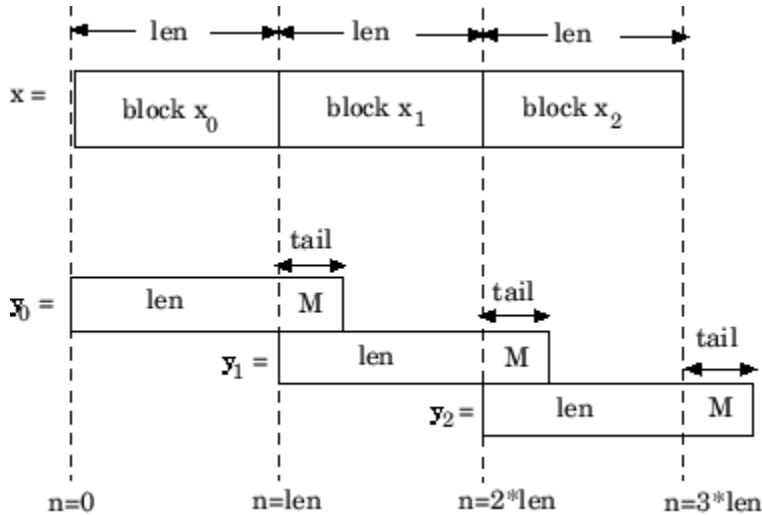

where len is the block length and M is the length of the numerator-1, $(length(b) - 1)$, which is also the number of states. The output of each convolution is a block that is longer than the input block by a tail of $(length(b) - 1)$ samples. These tails overlap the next block and are added to it. The states reported by `dfilt.fftfir` are the tails of the final convolution.

Examples

Create an FFT FIR discrete-time filter with coefficients from a 30th order lowpass equiripple design:

```
b = firpm(30,[0 .1 .2 .5]*2,[1 1 0 0]);
Hd = dfilt.fftfir(b)
```

To view the frequency domain coefficients used in the filtering, use the following command.

```
freq_coefs = fftcoefs(Hd);
```

See Also

`dfilt` | `dfilt.dffir` | `dfilt.dfasymfir` | `dfilt.dffirt` | `dfilt.dfsymfir`

Introduced before R2006a

dfilt.latticeallpass

Discrete-time, lattice allpass filter

Syntax

`Hd = dfilt.latticeallpass(k)`
`Hd = dfilt.latticeallpass`

Description

`Hd = dfilt.latticeallpass(k)` returns a discrete-time, lattice allpass filter, `Hd`, with lattice coefficients, `k`.

`Hd = dfilt.latticeallpass` returns a default, discrete-time, lattice allpass filter, `Hd`, with `k=[]`. This filter passes the input through to the output unchanged.

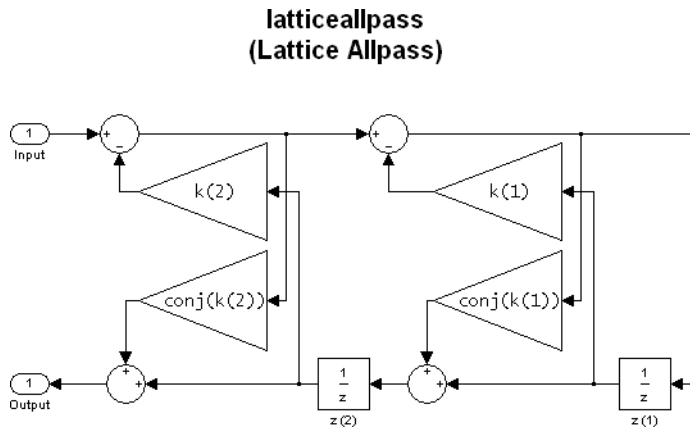

The resulting filter states column vector `Hd.States` is

$$\begin{pmatrix} z(1) \\ z(2) \end{pmatrix}$$

Examples

Form a third-order lattice allpass filter structure for a `dfilt` object, `Hd`, using the following lattice coefficients:

```
k = [.66 .7 .44];  
Hd = dfilt.latticeallpass(k)
```

See Also

`dfilt` | `dfilt.latticear` | `dfilt.latticearma` | `dfilt.latticemamax` | `dfilt.latticemamin`

Introduced before R2006a

dfilt.latticear

Discrete-time, lattice, autoregressive filter

Syntax

```
Hd = dfilt.latticear(k)
Hd = dfilt.latticear
```

Description

`Hd = dfilt.latticear(k)` returns a discrete-time, lattice autoregressive filter, `Hd`, with lattice coefficients, `k`.

`Hd = dfilt.latticear` returns a default, discrete-time, lattice autoregressive filter, `Hd`, with `k=[]`. This filter passes the input through to the output unchanged.

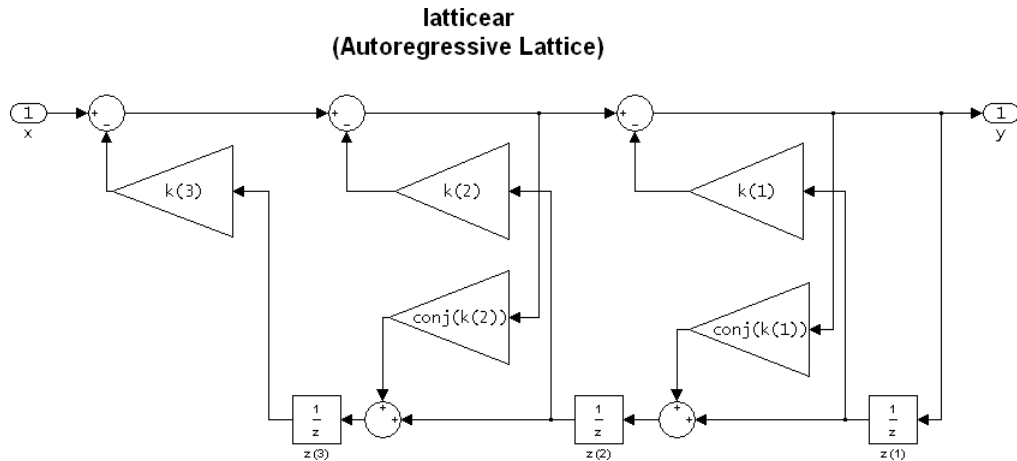

The resulting filter states column vector is

$$\begin{bmatrix} z(1) \\ z(2) \\ z(3) \end{bmatrix}$$

Examples

Form a third-order lattice autoregressive filter structure for a `dfilt` object, `Hd`, using the following lattice coefficients:

```
k = [.66 .7 .44];  
Hd = dfilt.latticear(k)
```

See Also

`dfilt` | `dfilt.latticeallpass` | `dfilt.latticearma` | `dfilt.latticemamax` |
`dfilt.latticemamin`

Introduced before R2006a

dfilt.latticearma

Discrete-time, lattice, autoregressive, moving-average filter

Syntax

```
Hd = dfilt.latticearma(k,v)
Hd = dfilt.latticearma
```

Description

`Hd = dfilt.latticearma(k,v)` returns a discrete-time, lattice autoregressive, moving-average filter, `Hd`, with lattice coefficients, `k` and ladder coefficients `v`.

`Hd = dfilt.latticearma` returns a default, discrete-time, lattice autoregressive, moving-average filter, `Hd`, with `k=[]` and `v=1`. This filter passes the input through to the output unchanged.

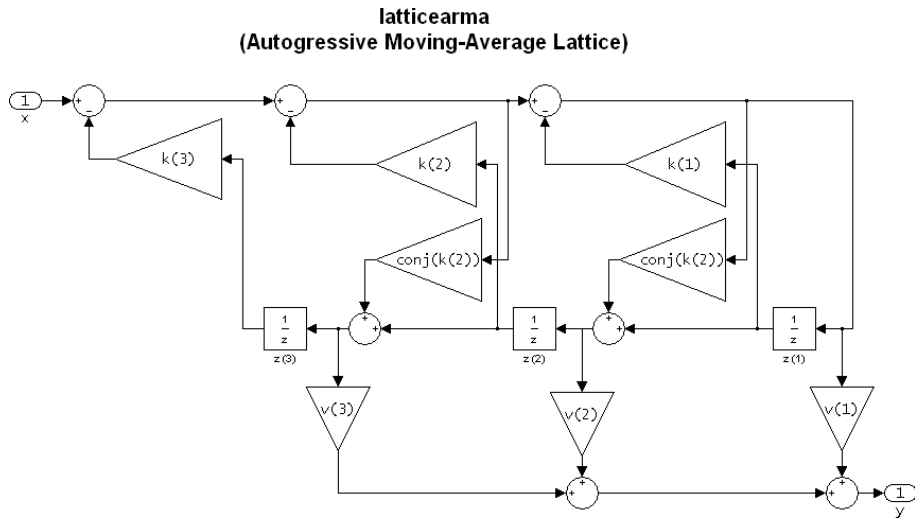

The resulting filter states column vector is

$$\begin{bmatrix} z(1) \\ z(2) \\ z(3) \end{bmatrix}$$

Examples

Form a third-order lattice autoregressive, moving-average filter structure for a `dfilt` object, `Hd`, using the following lattice coefficients:

```
k = [.66 .7 .44];  
Hd = dfilt.latticearma(k)
```

See Also

`dfilt` | `dfilt.latticeallpass` | `dfilt.latticear` | `dfilt.latticemamax` |
`dfilt.latticemamin`

Introduced before R2006a

dfilt.latticemamax

Discrete-time, lattice, moving-average filter

Syntax

```
Hd = dfilt.latticemamax(k)  
Hd = dfilt.latticemamax
```

Description

`Hd = dfilt.latticemamax(k)` returns a discrete-time, lattice, moving-average filter, `Hd`, with lattice coefficients `k`.

Note If the `k` coefficients define a maximum phase filter, the resulting filter in this structure is maximum phase. If your coefficients do not define a maximum phase filter, placing them in this structure does not produce a maximum phase filter.

`Hd = dfilt.latticemamax` returns a default discrete-time, lattice, moving-average filter, `Hd`, with `k=[]`. This filter passes the input through to the output unchanged.

latticemamax (Moving-Average, Maximum Phase Lattice)

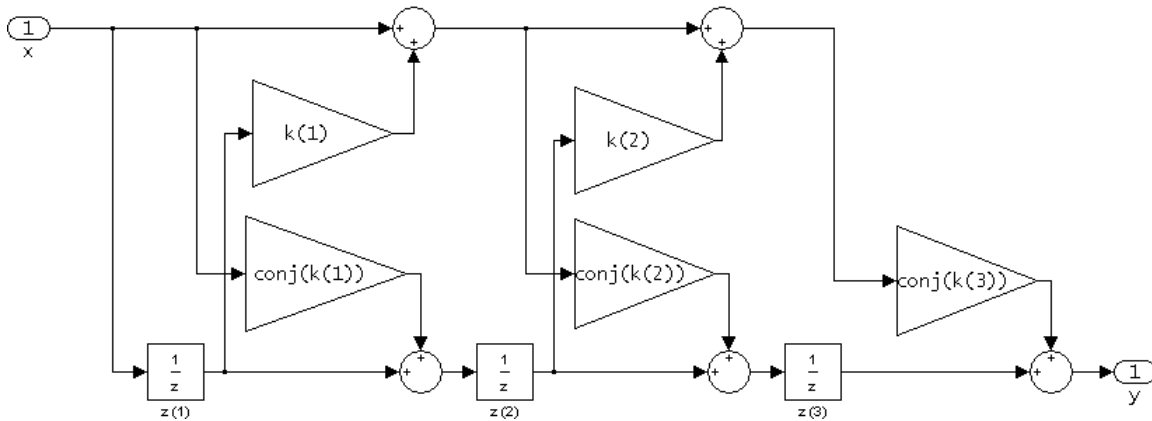

The resulting filter states column vector is

$$\begin{bmatrix} z(1) \\ z(2) \\ z(3) \end{bmatrix}$$

Examples

Form a fourth-order lattice, moving-average, maximum phase filter structure for a `dfilt` object, `Hd`, using the following lattice coefficients:

```
k = [.66 .7 .44 .33];
Hd = dfilt.latticemamax(k)
```

See Also

`dfilt` | `dfilt.latticeallpass` | `dfilt.latticear` | `dfilt.latticearma` | `dfilt.latticemamin`

Introduced before R2006a

dfilt.latticemamin

Discrete-time, lattice, moving-average filter

Syntax

```
Hd = dfilt.latticemamin(k)  
Hd = dfilt.latticemamin
```

Description

`Hd = dfilt.latticemamin(k)` returns a discrete-time, lattice, moving-average, minimum phase, filter, `Hd`, with lattice coefficients `k`.

Note If the `k` coefficients define a minimum phase filter, the resulting filter in this structure is minimum phase. If your coefficients do not define a minimum phase filter, placing them in this structure does not produce a minimum phase filter.

`Hd = dfilt.latticemamin` returns a default discrete-time, lattice, moving-average, minimum phase, filter, `Hd`, with `k=[]`. This filter passes the input through to the output unchanged.

latticemamin (Moving-Average, Minimum Phase Lattice)

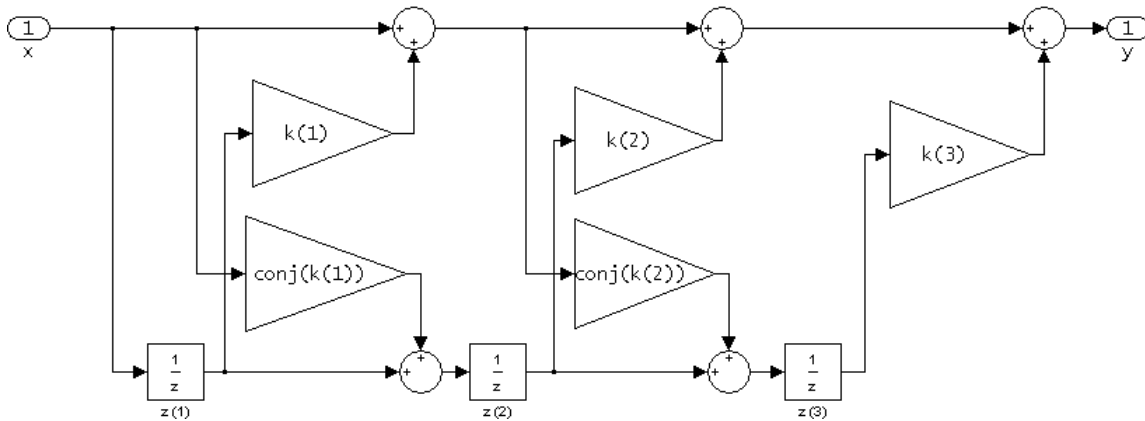

The resulting filter states column vector is

$$\begin{bmatrix} z(1) \\ z(2) \\ z(3) \end{bmatrix}$$

Examples

Form a third-order lattice, moving-average, minimum phase, filter structure for a `dfilt` object, `Hd`, using the following lattice coefficients.

```
k = [.66 .7 .44];
Hd = dfilt.latticemamin(k)
```

See Also

`dfilt` | `dfilt.latticeallpass` | `dfilt.latticear` | `dfilt.latticearma` | `dfilt.latticemamax`

Introduced before R2006a

dfilt.parallel

Discrete-time, parallel structure filter

Syntax

`Hd = dfilt.parallel(Hd1,Hd2,...)`

Description

`Hd = dfilt.parallel(Hd1,Hd2,...)` returns a discrete-time filter, `Hd`, which is a structure of two or more `dfilt` filters, `Hd1`, `Hd2`, etc. arranged in parallel. Each filter in a parallel structure is a separate stage. You can display states for individual stages only. To view the states of a stage use

`Hd.stage(1).states`

To append a filter (`Hd1`) onto an existing parallel filter (`Hd`), use

`addstage(Hd,Hd1)`

You can also use the nondot notation format for calling a parallel structure.

`parallel(Hd1,Hd2,...)`

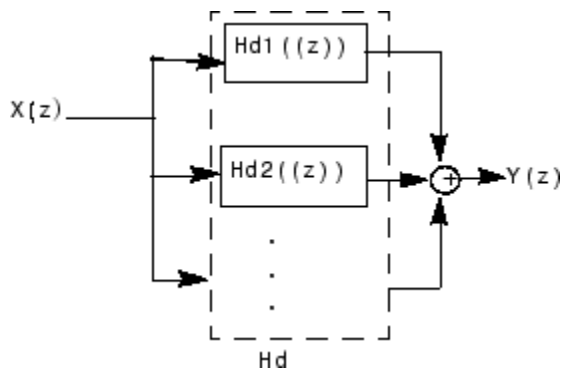

Examples

Using a parallel structure, create a coupled-allpass decomposition of a 7th order lowpass digital, elliptic filter with a normalized cutoff frequency of 0.5, 1 decibel of peak-to-peak ripple and a minimum stopband attenuation of 40 decibels.

```
k1 = [-0.0154    0.9846   -0.3048    0.5601];  
Hd1 = dfilt.latticeallpass(k1);  
k2 = [-0.1294    0.8341   -0.4165];  
Hd2 = dfilt.latticeallpass(k2);  
Hpar = parallel(Hd1 ,Hd2);  
gain = dfilt.scalar(0.5);    % Normalize passband gain  
Hcas = cascade(gain,Hpar);
```

For details on the stages of this filter, use

```
info(Hcas.Stage(1))
```

and

```
info(Hcas.Stage(2))
```

To view this filter, use

```
fvtool(Hcas)
```

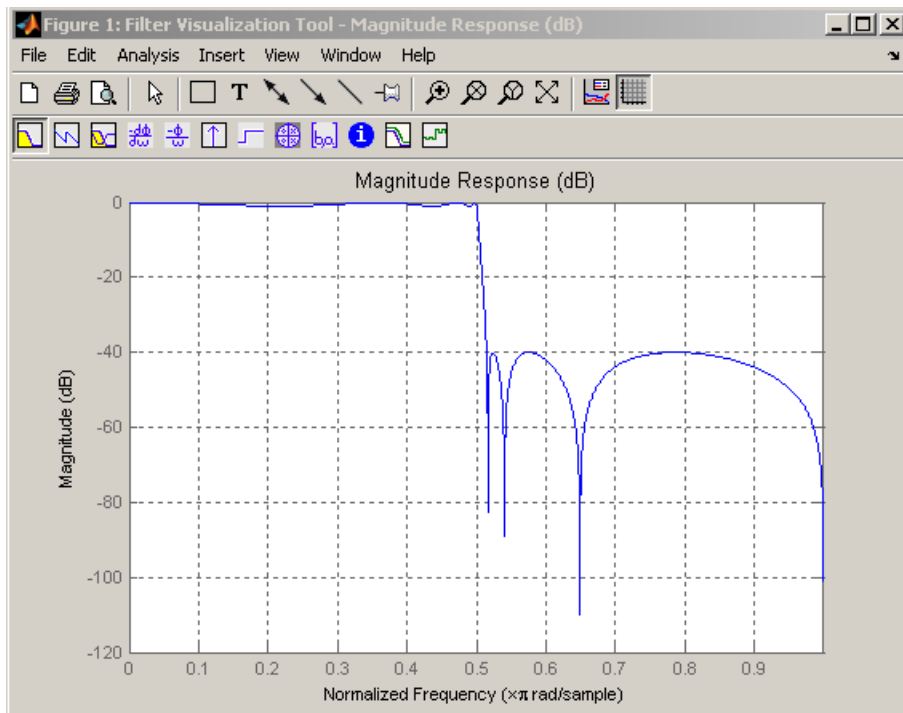

See Also

`dfilt` | `dfilt.cascade`

Introduced before R2006a

dfilt.scalar

Discrete-time, scalar filter

Syntax

```
Hd = dfilt.scalar(g)  
Hd = dfilt.scalar
```

Description

`Hd = dfilt.scalar(g)` returns a discrete-time, scalar filter, `Hd`, with gain `g`, where `g` is a scalar.

`Hd = dfilt.scalar` returns a default, discrete-time scalar gain filter, `Hd`, with gain 1.

Examples

Create a direct-form I filter and a scalar object with a gain of 3 and cascade them together.

```
b = [0.3 0.6 0.3];  
a = [1 0 0.2];  
Hd_filt = dfilt.df1(b,a);  
Hd_gain = dfilt.scalar(3);  
Hd_cascade = cascade(Hd_gain,Hd_filt);  
hfvtool(Hd_filt,Hd_gain,Hd_cascade);  
legend(hfvtool, 'Original Filter', 'Gain', 'Cascaded Filter', ...  
    'location', 'southwest');
```

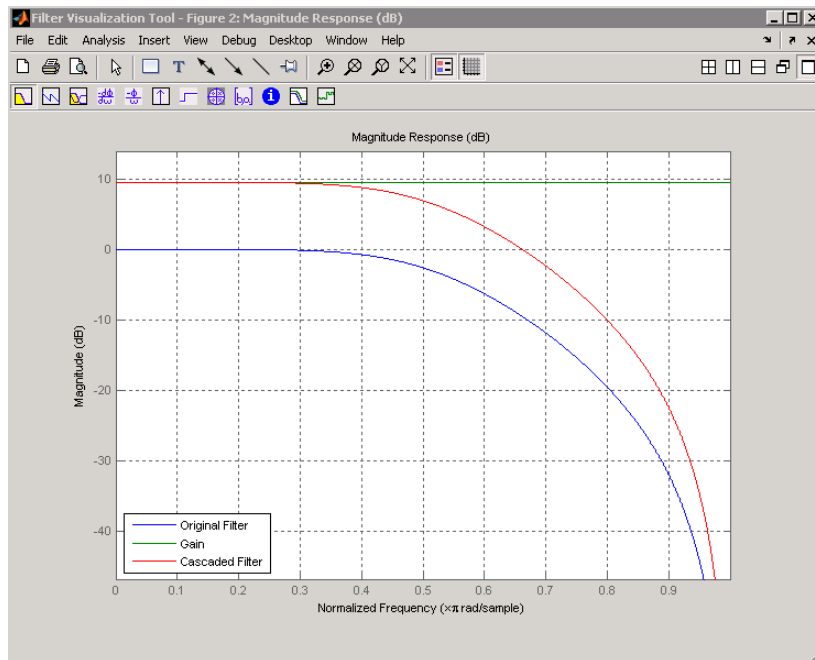

To view the stages of the cascaded filter, use

```
Hd.stage(1)
```

and

```
Hd.stage(2)
```

See Also

`dfilt` | `dfilt.cascade`

Introduced before R2006a

dfilt.statespace

Discrete-time, state-space filter

Syntax

```
Hd = dfilt.statespace(A,B,C,D)  
Hd = dfilt.statespace
```

Description

`Hd = dfilt.statespace(A,B,C,D)` returns a discrete-time state-space filter, `Hd`, with rectangular arrays `A`, `B`, `C`, and `D`.

`A`, `B`, `C`, and `D` are from the matrix or state-space form of a filter's difference equations

$$\begin{aligned}x(n+1) &= Ax(n) + Bu(n) \\ y(n) &= Cx(n) + Du(n)\end{aligned}$$

where $x(n)$ is the vector states at time n , $u(n)$ is the input at time n , y is the output at time n , A is the state-transition matrix, B is the input-to-state transmission matrix, C is the state-to-output transmission matrix, and D is the input-to-output transmission matrix. For single-channel systems, A is an m -by- m matrix where m is the order of the filter, B is a column vector, C is a row vector, and D is a scalar.

`Hd = dfilt.statespace` returns a default, discrete-time state-space filter, `Hd`, with `A=[]`, `B=[]`, `C=[]`, and `D=1`. This filter passes the input through to the output unchanged.

Statespace

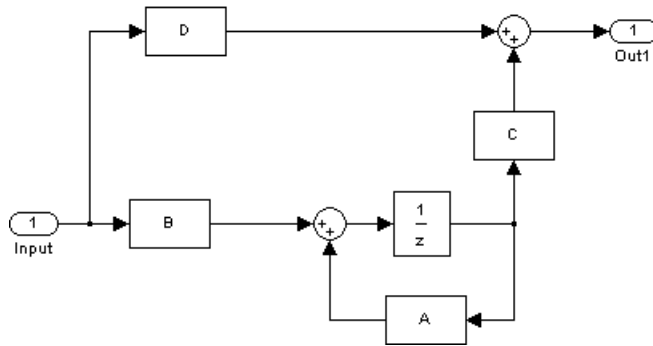

The resulting filter states column vector has the same number of rows as the number of rows of A or B.

Examples

Create a second-order, state-space filter structure from a second-order, lowpass Butterworth design.

```
[A,B,C,D] = butter(2,0.5);
Hd = dfilt.statespace(A,B,C,D)
```

See Also

dfilt

Introduced before R2006a

dftmtx

Discrete Fourier transform matrix

Syntax

```
A = dftmtx(n)
```

Description

A *discrete Fourier transform matrix* is a complex matrix of values around the unit circle whose matrix product with a vector computes the discrete Fourier transform of the vector.

`A = dftmtx(n)` returns the n -by- n complex matrix, A , that, when multiplied into a length- n column vector, x , computes the discrete Fourier transform of x . In other words, $y = A*x$ is the same as $y = \text{fft}(x)$.

The inverse discrete Fourier transform matrix is

```
Ai = conj(dftmtx(n))/n
```

Examples

The FFT and the DFT Matrix

In practice, it is more efficient to compute the discrete Fourier transform with the FFT than with the DFT matrix. The FFT also uses less memory. The two procedures give the same result.

```
x = 1:256;
```

```
y1 = fft(x);
```

```
n = length(x);
```

```
y2 = x*dftmtx(n);
```

```
norm(y1-y2)
```

```
ans = 7.7404e-12
```

Algorithms

dftmtx takes the FFT of the identity matrix to generate the transform matrix.

See Also

convmtx | fft

Introduced before R2006a

digitalFilter class

Digital filter

Description

- Use `designfilt` in the form `d = designfilt(resp,Name,Value)` to design a digital filter, `d`, with response type `resp`. Specify the filter further using a set of `Name,Value` pairs.
- Use `designfilt` in the form `designfilt(d)` to edit an existing filter, `d`.

Note: This is the only way to edit a `digitalFilter` object. Its properties are otherwise read-only.

- Use `filter` in the form `dataOut = filter(d,dataIn)` to filter a signal with a `digitalFilter`, `d`. The input can be a double- or single-precision vector. It can also be a matrix with as many columns as there are input channels.
- Use `fvtool` to visualize a `digitalFilter`, `d`.
- The following functions take `digitalFilter` objects as input.

Filtering and Analysis Functions

Filtering

Function	Description
<code>fftfilt</code>	Filters a signal with a <code>digitalFilter</code> using an FFT-based overlap-add method
<code>filter</code>	Filters a signal using a <code>digitalFilter</code>
<code>filtfilt</code>	Performs zero-phase filtering of a signal with a <code>digitalFilter</code>

Filter Analysis

Function	Description
<code>double</code>	Casts the coefficients of a <code>digitalFilter</code> to double precision

Function	Description
<code>filt2block</code>	Generates a Simulink filter block corresponding to a <code>digitalFilter</code>
<code>filtord</code>	Returns the filter order of a <code>digitalFilter</code>
<code>firtype</code>	Returns the type (1, 2, 3, or 4) of an FIR <code>digitalFilter</code>
<code>freqz</code>	Returns or plots the frequency response of a <code>digitalFilter</code>
<code>fvtool</code>	Opens the Filter Visualization Tool and displays the magnitude response of a <code>digitalFilter</code>
<code>grpdelay</code>	Returns or plots the group delay response of a <code>digitalFilter</code>
<code>impz</code>	Returns or plots the impulse response of a <code>digitalFilter</code>
<code>impzlength</code>	Returns the length of the impulse response of a <code>digitalFilter</code> , whether actual (for FIR filters) or effective (for IIR filters)
<code>info</code>	Returns a character array with information about a <code>digitalFilter</code>
<code>isallpass</code>	Returns <code>true</code> if a <code>digitalFilter</code> is allpass
<code>isdouble</code>	Returns <code>true</code> if the coefficients of a <code>digitalFilter</code> are double precision
<code>isfir</code>	Returns <code>true</code> if a <code>digitalFilter</code> has a finite impulse response
<code>islinphase</code>	Returns <code>true</code> if a <code>digitalFilter</code> has linear phase
<code>ismaxphase</code>	Returns <code>true</code> if a <code>digitalFilter</code> is maximum phase
<code>isminphase</code>	Returns <code>true</code> if a <code>digitalFilter</code> is minimum phase
<code>issingle</code>	Returns <code>true</code> if the coefficients of a <code>digitalFilter</code> are single precision
<code>isstable</code>	Returns <code>true</code> if a <code>digitalFilter</code> is stable
<code>phasedelay</code>	Returns or plots the phase delay response of a <code>digitalFilter</code>
<code>phasez</code>	Returns or plots the (unwrapped) phase response of a <code>digitalFilter</code>
<code>single</code>	Casts the coefficients of a <code>digitalFilter</code> to single precision

Function	Description
ss	Returns the state-space representation of a <code>digitalFilter</code>
stepz	Returns or plots the step response of a <code>digitalFilter</code>
tf	Returns the transfer function representation of a <code>digitalFilter</code>
zerophase	Returns or plots the zero-phase response of a <code>digitalFilter</code>
zpk	Returns the zero-pole-gain representation of a <code>digitalFilter</code>
zplane	Displays the poles and zeros of the transfer function represented by a <code>digitalFilter</code>

See Also

See Also

`designfilt` | `double` | `fftfilt` | `filt2block` | `filter` | `filtfilt` | `filtord` | `firtype` | `freqz` | `fvtool` | `grpdelay` | `impz` | `impzlength` | `info` | `isallpass` | `isdouble` | `isfir` | `islinphase` | `ismaxphase` | `isminphase` | `issingle` | `isstable` | `phasedelay` | `phasez` | `single` | `ss` | `stepz` | `tf` | `zerophase` | `zpk` | `zplane`

Introduced in R2014a

digitrevorder

Permute input into digit-reversed order

Syntax

```
y = digitrevorder(x,r)
[y,i] = digitrevorder(x,r)
```

Description

`digitrevorder` is useful for pre-ordering a vector of filter coefficients for use in frequency-domain filtering algorithms, in which the `fft` and `ifft` transforms are computed without digit-reversed ordering for improved run-time efficiency.

`y = digitrevorder(x,r)` returns the input data in digit-reversed order in vector or matrix `y`. The digit-reversal is computed using the number system base (radix base) `r`, which can be any integer from 2 to 36. The length of `x` must be an integer power of `r`. If `x` is a matrix, the digit reversal occurs on the first dimension of `x` with size greater than 1. `y` is the same size as `x`.

`[y,i] = digitrevorder(x,r)` returns the digit-reversed vector or matrix `y` and the digit-reversed indices `i`, such that `y = x(i)`. Recall that MATLAB matrices use 1-based indexing, so the first index of `y` will be 1, not 0.

The following table shows the numbers 0 through 15, the corresponding digits and the digit-reversed numbers using radix base-4. The corresponding radix base-2 bits and bit-reversed indices are also shown.

Linear Index	Base-4 Digits	Digit-Reversed	Digit-Reversed Index	Base-2 Bits	Base-2 Reversed (bitrevorder)	Bit-Reversed Index
0	00	00	0	0000	0000	0
1	01	10	4	0001	1000	8
2	02	20	8	0010	0100	4
3	03	30	12	0011	1100	12

Linear Index	Base-4 Digits	Digit-Reversed	Digit-Reversed Index	Base-2 Bits	Base-2 Reversed (bitrevorder)	Bit-Reversed Index
4	10	01	1	0100	0010	2
5	11	11	5	0101	1010	10
6	12	21	9	0110	0110	6
7	13	31	13	0111	1110	14
8	20	02	2	1000	0001	1
9	21	12	6	1001	1001	9
10	22	22	10	1010	0101	5
11	23	32	14	1011	1101	13
12	30	03	3	1100	0011	3
13	31	13	7	1101	1011	11
14	32	23	11	1110	0111	7
15	33	33	15	1111	1111	15

Examples

Base-3 Digit-Reversed Order

Obtain the digit-reversed, radix base-3 ordered output of a vector containing 9 values. Obtain the same result by converting to base 3 and reversing the digits.

```
x = (0:8)';
y = digitrevorder(x,3);

c1 = dec2base(x,3);
c2 = fliplr(c1);
c3 = base2dec(c2,3);

T = table(x,y,c1,c2,c3)

T = 9x5 table
    x     y   c1   c2   c3
    —     —   —    —    —
```

0	0	00	00	0
1	3	01	10	3
2	6	02	20	6
3	1	10	01	1
4	4	11	11	4
5	7	12	21	7
6	2	20	02	2
7	5	21	12	5
8	8	22	22	8

See Also

bitrevorder | fft | ifft

Introduced before R2006a

diric

Dirichlet or periodic sinc function

Syntax

```
y = diric(x,n)
```

Description

`y = diric(x,n)` returns a vector or array `y` the same size as `x`. The elements of `y` are the Dirichlet function of the elements of `x`. `n` must be a positive integer.

Examples

Dirichlet Function

Compute and plot the Dirichlet function between -2π and 2π for $N = 7$ and $N = 8$.

```
x = linspace(-2*pi,2*pi,301);  
  
d7 = diric(x,7);  
d8 = diric(x,8);  
  
subplot(2,1,1)  
plot(x/pi,d7)  
ylabel('N = 7')  
title('Dirichlet Function')  
  
subplot(2,1,2)  
plot(x/pi,d8)  
ylabel('N = 8')  
xlabel('x / \pi')
```

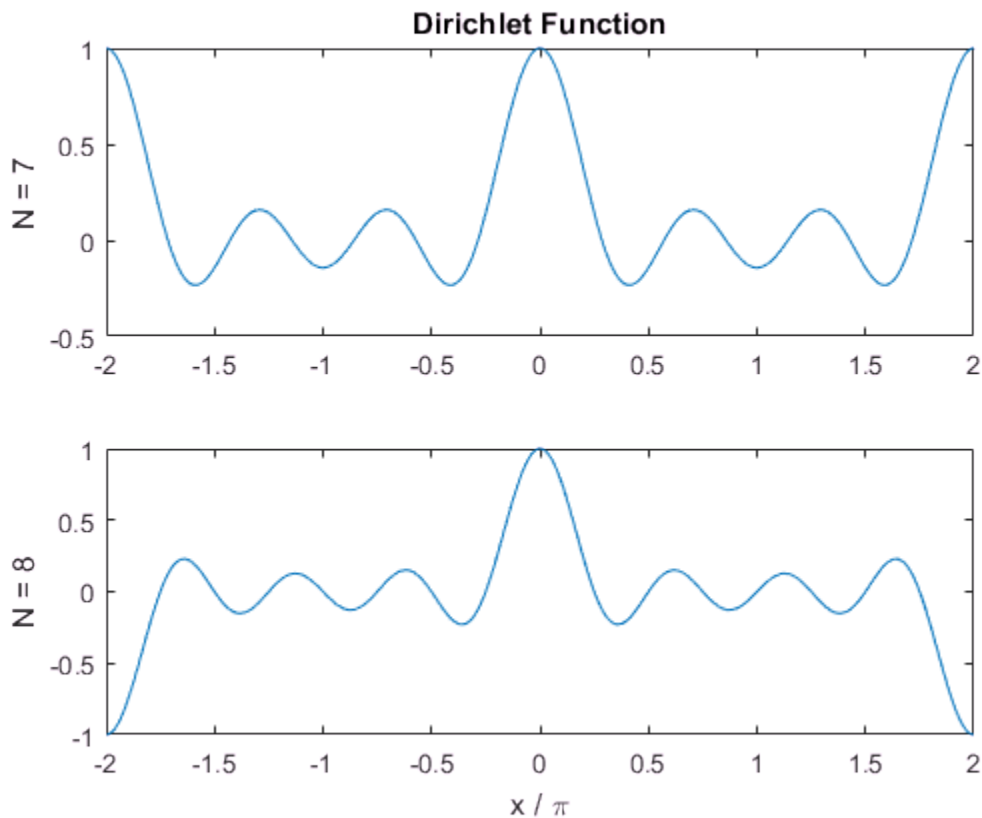

The function has a period of 2π for odd N and 4π for even N .

Periodic and Aperiodic Sinc Functions

The Dirichlet and sinc functions are related by $D_N(\pi x) = \text{sinc}(Nx/2) / \text{sinc}(x/2)$.

Illustrate this fact for $N = 6$.

```
xmax = 2;
x = linspace(-xmax,xmax,1001)';
```

```
N = 6;
```

```
yd = diric(x*pi,N);  
ys = sinc(N*x/2)./sinc(x/2);  
  
subplot(2,1,1)  
plot(x,yd)  
title('D_6(x*pi)')  
subplot(2,1,2)  
plot(x,ys)  
title('sinc(6*x/2) / sinc(x/2)')
```

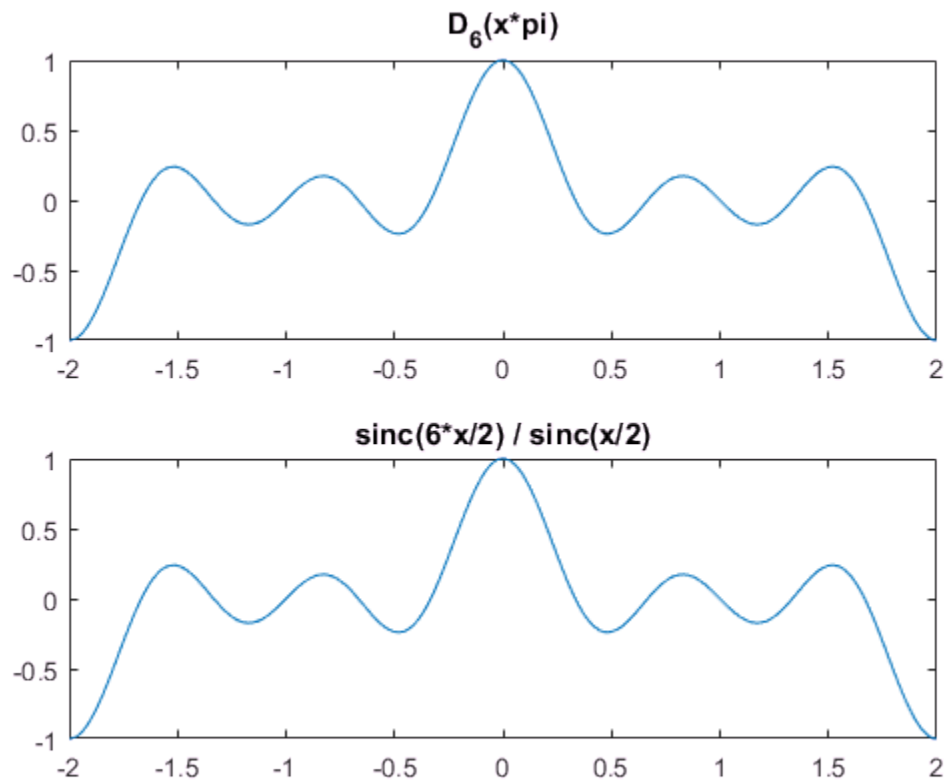

Repeat the calculation for $N = 9$.

```
N = 9;
```

```
yd = diric(x*pi,N);  
ys = sinc(N*x/2)./sinc(x/2);  
  
subplot(2,1,1)  
plot(x,yd)  
title('D_9(x*pi)')  
subplot(2,1,2)  
plot(x,ys)  
title('sinc(9*x/2) / sinc(x/2)')
```

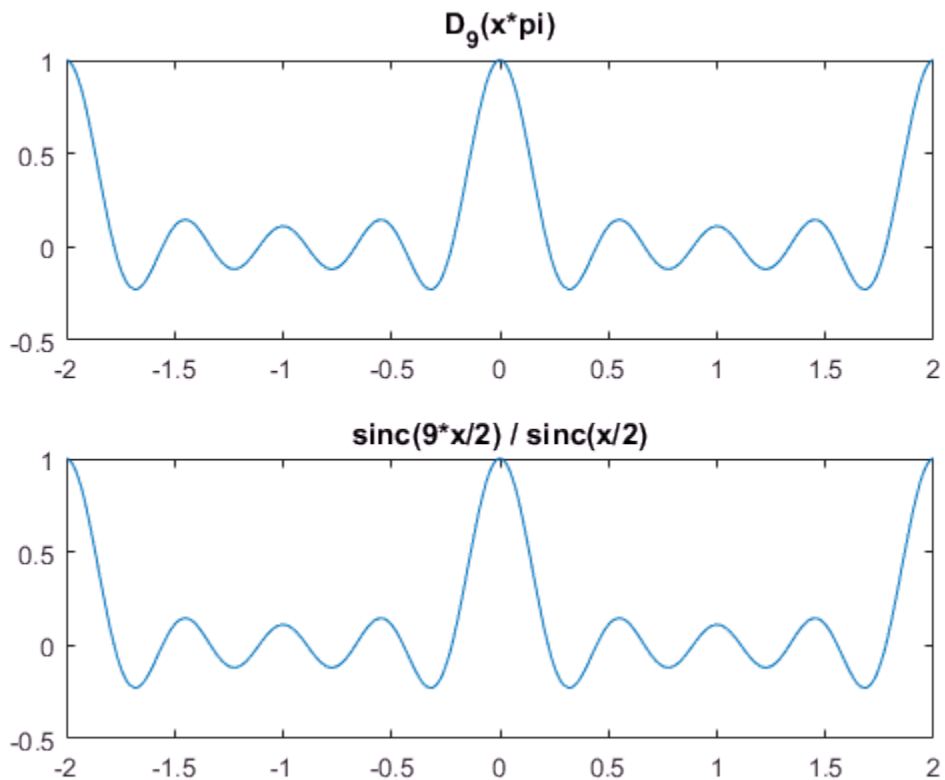

Diagnostics

If `n` is not a positive integer, `diric` gives the following error message:

```
Requires n to be a positive integer.
```

Definitions

Dirichlet Function

The Dirichlet function, or periodic sinc function, is

$$D_N(x) = \begin{cases} \frac{\sin(Nx/2)}{N \sin(x/2)} & x \neq 2\pi k, \quad k = 0, \pm 1, \pm 2, \pm 3, \dots \\ (-1)^{k(N-1)} & x = 2\pi k, \quad k = 0, \pm 1, \pm 2, \pm 3, \dots \end{cases}$$

for any nonzero integer N . This function has period 2π for odd N and period 4π for even N . Its peak value is 1, and its minimum value is -1 for even N . The magnitude of the function is $1/N$ times the magnitude of the discrete-time Fourier transform of the N -point rectangular window.

See Also

`cos` | `gauspuls` | `pulstran` | `rectpuls` | `sawtooth` | `sin` | `sinc` | `square` | `tripuls`

Introduced before R2006a

double

Cast coefficients of digital filter to double precision

Syntax

```
f2 = double(f1)
```

Description

`f2 = double(f1)` casts coefficients in a digital filter, `f1`, to double precision and returns a new digital filter, `f2`, that contains these coefficients.

Examples

Lowpass FIR Filter in Single and Double Precision

Use `designfilt` to design a 5th-order FIR lowpass filter. Specify a normalized passband frequency of 0.2π rad/sample and a normalized stopband frequency of 0.55π rad/sample.

Cast the filter to single precision and cast it back to double precision. Display the first coefficient of each filter.

```
format long
d = designfilt('lowpassfir','FilterOrder',5, ...
              'PassbandFrequency',0.2,'StopbandFrequency', 0.55);
e = single(d);
f = double(e);

coed = d.Coefficients(1)

coed =
    0.003947882145754

coee = e.Coefficients(1)
```

```
coee = single
      0.0039479

coef = f.Coefficients(1)

coef =
      0.003947881981730
```

Use **double** to analyze, in double precision, the effects of single-precision quantization of filter coefficients.

Input Arguments

f1 — Single-precision digital filter

digitalFilter object

Single-precision digital filter, specified as a digitalFilter object. Use **designfilt** to generate a digital filter based on frequency-response specifications and **single** to cast it to single precision.

Example: `f1=`

```
single(designfilt('lowpassfir','FilterOrder',3,'HalfPowerFrequency',0.5))
```

specifies a third-order Butterworth filter with normalized 3-dB frequency 0.5π rad/sample cast in single precision.

Output Arguments

f2 — Double-precision digital filter

digitalFilter object

Double-precision digital filter, returned as a digitalFilter object.

See Also

See Also

`designfilt` | `digitalFilter` | `isdouble` | `issingle` | `single`

Introduced in R2014a

downsample

Decrease sampling rate by integer factor

Syntax

```
y = downsample(x,n)
y = downsample(x,n,phase)
```

Description

`y = downsample(x,n)` decreases the sampling rate of `x` by keeping every `n`th sample starting with the first sample. `x` can be a vector or a matrix. If `x` is a matrix, each column is considered a separate sequence.

`y = downsample(x,n,phase)` specifies the number of samples by which to offset the downsampled sequence. `phase` must be an integer from 0 to `n - 1`.

Examples

Decrease Sampling Rates

Decrease the sampling rate of a sequence by 3.

```
x = [1 2 3 4 5 6 7 8 9 10];
y = downsample(x,3)
```

```
y =
     1     4     7    10
```

Decrease the sampling rate of the sequence by 3 and add a phase offset of 2.

```
y = downsample(x,3,2)
```

```
y =
```

```
3     6     9
```

Decrease the sampling rate of a matrix by 3.

```
x = [1  2  3;  
     4  5  6;  
     7  8  9;  
    10 11 12];  
y = downsample(x,3)
```

```
y =
```

```
1     2     3  
10    11    12
```

Extended Capabilities

C/C++ Code Generation

Generate C and C++ code using MATLAB® Coder™.

See Also

[interp](#) | [decimate](#) | [interp1](#) | [resample](#) | [spline](#) | [upfirdn](#) | [upsample](#)

Introduced before R2006a

dpss

Discrete prolate spheroidal (Slepian) sequences

Syntax

```

dps_seq = dpss(seq_length,time_halfbandwidth)
[dps_seq,lambda] = dpss(seq_length,time_halfbandwidth)
[...] = dpss(seq_length,time_halfbandwidth,num_seq)
[...] = dpss(seq_length,time_halfbandwidth,'interp_method')
[...] = dpss(...,Ni)
[...] = dpss(...,'trace')

```

Description

`dps_seq = dpss(seq_length,time_halfbandwidth)` returns the first $\text{round}(2 \cdot \text{time_halfbandwidth})$ discrete prolate spheroidal (DPSS), or Slepian sequences of length `seq_length`. `dps_seq` is a matrix with `seq_length` rows and $\text{round}(2 \cdot \text{time_halfbandwidth})$ columns. `time_halfbandwidth` must be strictly less than `seq_length/2`.

`[dps_seq,lambda] = dpss(seq_length,time_halfbandwidth)` returns the frequency-domain energy concentration ratios of the column vectors in `dps_seq`. The ratios represent the amount of energy in the passband $[-W,W]$ to the total energy from $[-F_s/2,F_s/2]$, where F_s is the sampling frequency. `lambda` is a column vector equal in length to the number of Slepian sequences.

`[...] = dpss(seq_length,time_halfbandwidth,num_seq)` returns the first `num_seq` Slepian sequences with time half bandwidth product `time_halfbandwidth` ordered by their energy concentration ratios. If `num_seq` is a two-element vector, the returned Slepian sequences range from `num_seq(1)` to `num_seq(2)`.

`[...] = dpss(seq_length,time_halfbandwidth,'interp_method')` uses interpolation to compute the DPSSs from a user-created database of DPSSs. Create the database of DPSSs with `dpsssave` and ensure that the resulting file, `dpss.mat`, is in the MATLAB search path. Valid options for `'interp_method'` are `'spline'` and

'linear'. The interpolation method uses the Slepian sequences in the database with time half bandwidth product `time_halfbandwidth` and length closest to `seq_length`.

[...] = `dpss(...,Ni)` interpolates from DPSSs of length `Ni` in the database `dpss.mat`.

[...] = `dpss(...,'trace')` prints the method used to compute the DPSSs in the command window. Possible methods include: direct, spline interpolation, and linear interpolation.

Examples

Generate a Set of Slepian Sequences

Construct the first four discrete prolate spheroidal sequences of length 512. Specify a time half bandwidth product of 2.5. Plot the sequences and find the concentration ratios.

```
seq_length = 512;
time_halfbandwidth = 2.5;
num_seq = 2*(2.5)-1;
[dps_seq,lambda] = dpss(seq_length,time_halfbandwidth,num_seq);

plot(dps_seq)
title('Slepian Sequences, N = 512, NW = 2.5')
axis([0 512 -0.15 0.15])
legend('1st','2nd','3rd','4th')
```

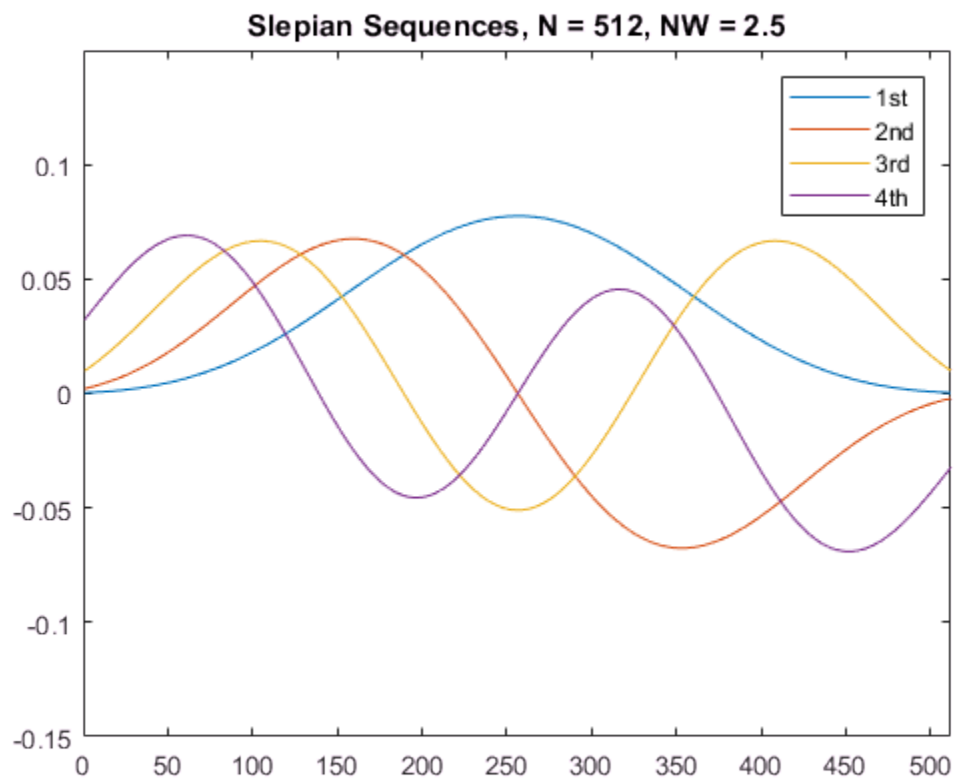
```
concentration_ratios = lambda'
```

```
concentration_ratios =
```

```
1.0000  0.9998  0.9962  0.9521
```

Definitions

Discrete Prolate Spheroidal Sequences

The discrete prolate spheroidal or Slepian sequences derive from the following time-frequency concentration problem. For all finite-energy sequences $x[n]$ index limited to some set $[N_1, N_1 + N_2]$, which sequence maximizes the following ratio:

$$\lambda = \frac{\int_{-W}^W |X(f)|^2 df}{\int_{-Fs/2}^{Fs/2} |X(f)|^2 df}$$

where F_s is the sampling frequency and $|W| < Fs/2$. Accordingly, this ratio determines which index-limited sequence has the largest proportion of its energy in the band $[-W, W]$. For index-limited sequences, the ratio must satisfy the inequality $0 < \lambda < 1$. The sequence maximizing the ratio is the first discrete prolate spheroidal or Slepian sequence. The second Slepian sequence maximizes the ratio and is orthogonal to the first Slepian sequence. The third Slepian sequence maximizes the ratio of integrals and is orthogonal to both the first and second Slepian sequences. Continuing in this way, the Slepian sequences form an orthogonal set of bandlimited sequences.

Time Half Bandwidth Product

The time half bandwidth product is NW where N is the length of the sequence and $[-W, W]$ is the effective bandwidth of the sequence. In constructing Slepian sequences, you choose the desired sequence length and bandwidth $2W$. Both the sequence length and bandwidth affect how many Slepian sequences have concentration ratios near one. As a rule, there are $2NW - 1$ Slepian sequences with energy concentration ratios approximately equal to one. Beyond $2NW - 1$ Slepian sequences, the concentration ratios begin to approach zero. Common choices for the time half bandwidth product are: 2.5, 3, 3.5, and 4.

You can specify the bandwidth of the Slepian sequences in Hz by defining the time half bandwidth product as NW/F_s , where F_s is the sampling frequency.

References

Percival, D. B., and A. T. Walden. *Spectral Analysis for Physical Applications*. Cambridge, UK: Cambridge University Press, 1993.

Extended Capabilities

C/C++ Code Generation

Generate C and C++ code using MATLAB® Coder™.

Usage notes and limitations:

All inputs must be constants. Expressions or variables are allowed if their values do not change.

See Also

`dpssc` | `dpssload` | `dpsssave` | `pmtm`

Topics

“Nonparametric Methods”

Introduced before R2006a

dpsscLEAR

Remove discrete prolate spheroidal sequences from database

Syntax

```
dpsscLEAR(n,nw)
```

Description

`dpsscLEAR(n,nw)` removes sequences with length `n` and time-bandwidth product `nw` from the DPSS MAT-file database `dpss.mat`.

See Also

`dpss` | `dpssdir` | `dpssload` | `dpsssave`

Introduced before R2006a

dpssdir

Discrete prolate spheroidal sequences database directory

Syntax

```
dpssdir  
dpssdir(n)  
dpssdir(nw, 'nw')  
dpssdir(n,nw)  
index = dpssdir
```

Description

`dpssdir` manages the database directory that contains the generated DPSS samples in the DPSS MAT-file database `dpss.mat`. Create the DPSS MAT-file database with `dpsssave`.

`dpssdir` lists the directory of saved sequences in `dpss.mat`.

`dpssdir(n)` lists the sequences saved with length `n`.

`dpssdir(nw, 'nw')` lists the sequences saved with time-bandwidth product `nw`.

`dpssdir(n,nw)` lists the sequences saved with length `n` and time-bandwidth product `nw`.

`index = dpssdir` is a structure array describing the DPSS database. Pass `n` and `nw` options as for the no output case to get a filtered `index`.

See Also

`dpss` | `dpssc` | `dpssclear` | `dpssload` | `dpsssave`

Introduced before R2006a

dpssload

Load discrete prolate spheroidal sequences from database

Syntax

```
[e,v] = dpssload(n,nw)
```

Description

`[e,v] = dpssload(n,nw)` loads all sequences with length `n` and time-bandwidth product `nw` in the columns of `e` and their corresponding concentrations in vector `v` from the DPSS MAT-file database `dpss.mat`. Create the `dpss.mat` file using `dpssave`.

See Also

`dpss` | `dpssc` | `dpsscdir` | `dpsssave`

Introduced before R2006a

dpsssave

Discrete prolate spheroidal or Slepian sequence database

Syntax

```
dpsssave(time_halfbandwidth,dps_seq,lambda)
status = dpsssave(time_halfbandwidth,dps_seq,lambda)
```

Description

`dpsssave(time_halfbandwidth,dps_seq,lambda)` creates a database of discrete prolate spheroidal (DPSS) or Slepian sequences and saves the results in `dpss.mat`. The time half bandwidth product `time_halfbandwidth` is a real-valued scalar determining the frequency concentration of the Slepian sequences in `dps_seq`. `dps_seq` is a $N \times K$ matrix of Slepian sequences where N is the length of the sequences. `lambda` is a $1 \times K$ vector containing the frequency concentration ratios of the Slepian sequences in `dps_seq`.

If the database `dpss.mat` exists, subsequent calls to `dpsssave` append the Slepian sequences to the existing file. If the sequences are already in the existing file, `dpsssave` overwrites the old values and issues a warning.

`status = dpsssave(time_halfbandwidth,dps_seq,lambda)` returns a 0 if the database operation was successful or a 1 if unsuccessful.

Examples

Create a Database of Slepian Sequences

Construct the first four discrete prolate spheroidal sequences of length 512. Specify a time half bandwidth product of 2.5. Use them to create a database of Slepian sequences, `dpss.mat`, in the current working directory. The output variable, `status`, is 0 if there is success.

```
seq_length = 512;
```

```
time_halfbandwidth = 2.5;
num_seq = 4;
[dps_seq,lambda] = dpss(seq_length,time_halfbandwidth);
status = dpsssave(time_halfbandwidth,dps_seq,lambda)

status = 0
```

Definitions

Discrete Prolate Spheroidal Sequences

The discrete prolate spheroidal or Slepian sequences derive from the following time-frequency concentration problem. For all finite-energy sequences $x[n]$ index limited to some set $[N_1, N_1 + N_2]$, which sequence maximizes the following ratio:

$$\lambda = \frac{\int_{-W}^W |X(f)|^2 df}{\int_{-Fs/2}^{Fs/2} |X(f)|^2 df}$$

where F_s is the sampling frequency and $|W| < F_s / 2$. Accordingly, this ratio determines which index-limited sequence has the largest proportion of its energy in the band $[-W, W]$. For index-limited sequences, the ratio must satisfy the inequality $0 < \lambda < 1$. The sequence maximizing the ratio is the first discrete prolate spheroidal or Slepian sequence. The second Slepian sequence maximizes the ratio and is orthogonal to the first Slepian sequence. The third Slepian sequence maximizes the ratio of integrals and is orthogonal to both the first and second Slepian sequences. Continuing in this way, the Slepian sequences form an orthogonal set of bandlimited sequences.

Time Half Bandwidth Product

The time half bandwidth product is NW where N is the length of the sequence and $[-W, W]$ is the effective bandwidth of the sequence. In constructing Slepian sequences, you choose the desired sequence length and bandwidth $2W$. Both the sequence length

and bandwidth affect how many Slepian sequences have concentration ratios near one. As a rule, there are $2NW - 1$ Slepian sequences with energy concentration ratios approximately equal to one. Beyond $2NW - 1$ Slepian sequences, the concentration ratios begin to approach zero. Common choices for the time half bandwidth product are: 2.5, 3, 3.5, and 4.

You can specify the bandwidth of the Slepian sequences in Hz by defining the time half bandwidth product as NW/F_s , where F_s is the sampling frequency.

References

Percival, D. B., and A. T. Walden. *Spectral Analysis for Physical Applications*. Cambridge, UK: Cambridge University Press, 1993.

See Also

`dpss` | `dpssc` | `dpssc` | `dpssdir` | `dpssload`

Introduced before R2006a

dspdata

DSP data parameter information

Syntax

```
Hs = dspdata.dataobj(input1,...)
```

Description

Note: The use of `dspdata.dataobj` is not recommended. Use the appropriate function interface instead.

`Hs = dspdata.dataobj(input1,...)` returns a `dspdata` object `Hs` of type `dataobj`. This object contains all the parameter information needed for the specified type of `dataobj`. Each `dataobj` takes one or more inputs, which are described on the individual reference pages. If you do not specify any input values, the returned object has default property values appropriate for the particular `dataobj` type.

Note You must use a `dataobj` with `dspdata`.

Data Objects

A data object, `dataobj`, for `dspdata` specifies the type of data stored in the object. Available `dataobj` types for `dspdata` are shown below.

<code>dspdata.dataobj</code>	Description	Corresponding Functions
<code>dspdata.msspectr</code>	Mean-square spectrum data (power)	<code>periodogram</code> <code>pwelch</code>
<code>dspdata.psd</code>	Power spectral density data (power/frequency)	<code>pburg</code> <code>pcov</code>

<code>dspdata.dataobj</code>	Description	Corresponding Functions
		<p>periodogram</p> <p>pmcov</p> <p>pmtm</p> <p>pwelch</p> <p>pyulear</p>
<code>dspdata.pseudosp</code>	Pseudospectrum data (power)	<p>peig</p> <p>pmusic</p>

For more information on each *dataobj* type, use the syntax `help dspdata.dataobj` at the MATLAB prompt or refer to its reference page.

Methods

Methods provide ways of performing functions directly on your `dspdata` object. You can apply these methods directly on the variable you assigned to your `dspdata` object.

Method	Description
<code>avgpower</code>	<p>This method applies only to <code>dspdata.psd</code> objects.</p> <p><code>avgpower(Hs)</code> computes the average power of a signal, <code>Hs</code>, in a given frequency band. The technique uses a rectangle approximation of the integral of the signal's power spectral density (PSD). If the signal is a matrix, the computation is done on each column. The average power is the total signal power. The <code>SpectrumType</code> property determines whether the total average power is contained in the one-sided or the two-sided spectrum. For a one-sided spectrum, the range is <code>[0,pi]</code> if the number of frequency points is even and <code>[0,pi]</code> if it is odd. For a two-sided spectrum, the range is <code>[0,2pi]</code>.</p> <p><code>avgpower(Hs, freqrange)</code> specifies the frequency range over which to calculate the average power. <code>freqrange</code> is a two-element vector containing the lower and upper bounds</p>

Method	Description
	<p>of the frequency range. If a frequency value does not match exactly the frequency in <code>HS</code>, the next closest value is used. The first frequency value in <code>freqrange</code> is included in the calculation and the second value is excluded.</p>
<p><code>centerdc</code></p>	<p><code>centerdc(Hs)</code> or <code>centerdc(Hs, true)</code> shifts the data and frequency values so that the DC component is at the center of the spectrum. If the <code>SpectrumType</code> property is <code>'onesided'</code>, it is changed to <code>'twosided'</code> and then the DC component is centered.</p> <p><code>centerdc(Hs, 'false')</code> shifts the data and frequency values so that the DC component is at the left edge of the spectrum.</p>

Method	Description
findpeaks	<p><code>findpeaks(Hs)</code> finds local maxima or peaks. If no peaks are found, <code>findpeaks</code> returns an empty vector.</p> <p><code>[pks,frqs] = findpeaks(x)</code> returns the peaks' values, <code>pks</code>, and the frequencies, <code>frqs</code>, at which they occur.</p> <p><code>findpeaks(x, 'minpeakheight', mph)</code> returns only peaks greater than the minimum peak height <code>mph</code>, where <code>mph</code> is a real scalar. The default is <code>-Inf</code>.</p> <p><code>findpeaks(x, 'minpeakdistance', mpd)</code> returns only peaks separated by the minimum frequency units distance <code>mpd</code>, which is a positive integer. Setting the minimum peak distance ignores smaller peaks that may occur close to larger local peaks. The default is 1.</p> <p><code>findpeaks(x, 'threshold', th)</code> returns only peaks greater than their neighbors by at least the threshold, <code>th</code>, which is a real, scalar value greater than or equal to 0. The default is 0.</p> <p><code>findpeaks(x, 'npeaks', np)</code> returns a maximum of <code>np</code> number of peaks. When <code>np</code> peaks are found, the search stops. The default is to return all peaks.</p> <p><code>findpeaks(x, 'sortstr', str)</code> specifies the sorting order, where <code>str</code> is <code>'ascend'</code>, <code>'descend'</code>, or <code>'none'</code>. When <code>str</code> is set to <code>'ascend'</code>, the peaks are sorted from smallest to largest. When <code>str</code> is set to <code>'descend'</code> the peaks are sorted in descending order. When <code>str</code> is set to <code>'none'</code>, the peaks are returned in the order in which they occur.</p>

Method	Description
<p><code>halfrange</code></p>	<p><code>halfrange(Hs)</code> converts the spectrum of <code>Hs</code> to a spectrum calculated over half the Nyquist interval. All associated properties affected by the new frequency range are adjusted automatically. This method is used for <code>dspdata.pseudospectrum</code> objects.</p> <p>The spectrum is assumed to be from a real signal. That is, <code>halfrange</code> uses half the data points regardless of whether the data is symmetric.</p>
<p><code>normalizefreq</code></p>	<p><code>normalizefreq(Hs)</code> or <code>normalizefreq(Hs, true)</code> normalizes the frequency specifications in the <code>Hs</code> object to <code>Fs</code> so the frequencies are between 0 and 1. It also sets the <code>NormalizedFrequency</code> property to <code>true</code>.</p> <p><code>normalizefreq(Hs, false)</code> converts the frequencies to linear frequencies.</p> <p><code>normalizefreq(Hs, false, Fs)</code> sets a new sampling frequency, <code>Fs</code>. This can be used only with <code>false</code>.</p>
<p><code>onesided</code></p>	<p><code>onesided(Hs)</code> converts the spectrum of <code>Hs</code> to a spectrum calculated over half the Nyquist interval and containing the total signal power. All associated properties affected by the new frequency range are adjusted automatically. This method is used for <code>dspdata.psd</code> and <code>dspdata.msspectrum</code> objects.</p> <p>The spectrum is assumed to be from a real signal. That is, <code>onesided</code> uses half the data points regardless of whether the data is symmetric.</p>

Method	Description
plot	<p>Displays the data graphically in the current figure window.</p> <p>For a <code>dspdata.psd</code> object, it displays the power spectral density in dB/Hz.</p> <p>For a <code>dspdata.msspectrum</code> object, it displays the mean-square in dB.</p> <p>For a <code>dspdata.pseudospectrum</code> object, it displays the pseudospectrum in dB.</p>
sfdr	<p>This method applies only to <code>dspdata.msspectrum</code> objects.</p> <p><code>sfdr(Hs)</code> computes the spurious-free dynamic range (SFDR) in dB of a mean square spectrum object <code>Hs</code>. SFDR is the usable range before spurious noise interferes with the signal.</p> <p><code>[sfd, spur, frq] = sfdr(Hs)</code> returns the magnitude of the highest spur and the frequency <code>frq</code> at which it occurs.</p> <p><code>sfdr(Hs, 'minspurlevel', msl)</code> ignores spurs below the minimum spur level <code>msl</code>, which is a real scalar in dB.</p> <p><code>sfdr(Hs, 'minspurdistance', msd)</code> includes spurs only if they are separated by at least the minimum spur distance <code>msd</code>, which is a real, positive scalar in frequency units.</p>
twosided	<p><code>twosided(Hs)</code> converts the <code>Hs</code> spectrum to a spectrum calculated over the whole Nyquist interval. All associated properties affected by the new frequency range are adjusted automatically. This method is used for <code>dspdata.psd</code> and <code>dspdata.msspectrum</code> objects.</p> <p>If your data is nonuniformly sampled, converting from <code>onesided</code> to <code>twosided</code> may produce incorrect results.</p>

Method	Description
<code>wholerange</code>	<p><code>wholerange(Hs)</code> converts the <code>Hs</code> spectrum to a spectrum calculated over the whole Nyquist interval. All associated properties affected by the new frequency range are adjusted automatically. This method is used for <code>dspdata.pseudospectrum</code> objects.</p> <p>If your data is nonuniformly sampled, converting from <code>half</code> to <code>wholerange</code> may produce incorrect results.</p>

For more information on each method, use the syntax `help dspdata/method` at the MATLAB prompt.

Plotting a `dspdata` Object

The `plot` method displays the `dspdata` object spectrum in a separate figure window.

Modifying a `dspdata` Object

After you create a `dspdata` object, you can use any of the methods in the table above to modify the object properties. For example, to change an object, `Hs`, from two-sided to one-sided, use `onesided(Hs)`.

Examples

See the `dspdata.msspectrum`, `dspdata.psd`, and `dspdata.pseudospectrum` reference pages for specific examples.

See Also

`pburg` | `pcov` | `peig` | `periodogram` | `pmcov` | `pmtm` | `pmusic` | `pwelch` | `pyulear`

Introduced before R2006a

dspdata.msspectrum

Mean-square (power) spectrum

Syntax

```
Hmss = dspdata.msspectrum(Data)
Hmss = dspdata.msspectrum(Data,Frequencies)
Hmss = dspdata.msspectrum(...,'Fs',Fs)
Hmss = dspdata.msspectrum(...,'SpectrumType',SpectrumType)
Hmss = dspdata.msspectrum(...,'CenterDC',flag)
```

Description

Note: The use of `dspdata.msspectrum` is not recommended. Use `periodogram` or `pwelch` instead.

The mean-squared spectrum (MSS) is intended for discrete spectra. Unlike the power spectral density (PSD), the peaks in the MSS reflect the power in the signal at a given frequency. The MSS of a signal is the Fourier transform of that signal's autocorrelation.

`Hmss = dspdata.msspectrum(Data)` uses the mean-square (power) spectrum data contained in `Data`, which can be in the form of a vector or a matrix, where each column is a separate set of data. Default values for other properties of the object are as follows:

Property	Default Value	Description
Name	'Mean-square Spectrum'	Read-only character vector
Frequencies	[] type double	<p>Vector of frequencies at which the spectrum is evaluated. The range of this vector depends on the SpectrumType value. For a one-sided spectrum, the default range is $[0, \pi]$ or $[0, Fs/2)$ for odd length, and $[0, \pi]$ or $[0, Fs/2]$ for even length, if Fs is specified. For a two-sided spectrum, it is $[0, 2\pi]$ or $[0, Fs)$.</p> <p>The length of the Frequencies vector must match the length of the columns of Data.</p> <p>If you do not specify Frequencies, a default vector is created. If one-sided is selected, then the whole number of FFT points (nFFT) for this vector is assumed to be even.</p> <p>If onesided is selected and you specify Frequencies, the last frequency point is compared to the next-to-last point and to π (or $Fs/2$, if Fs is specified). If the last point is closer to π (or $Fs/2$) than it is to the previous point, nFFT is assumed to be even. If it is closer to the previous point, nFFT is assumed to be odd.</p>
Fs	'Normalized'	Sampling frequency, which is 'Normalized' if NormalizedFrequency is true. If NormalizedFrequency is false Fs defaults to 1 Hz.

Property	Default Value	Description
SpectrumType	'Onesided'	<p>Nyquist interval over which the spectral density is calculated. Valid values are 'Onesided' and 'Twosided'. See the <code>onesided</code> and <code>twosided</code> methods in <code>dspdata</code> for information on changing this property.</p> <p>The interval for <code>Onesided</code> is $[0 \pi]$ or $[0 \pi]$ depending on the number of FFT points, and for <code>Twosided</code> the interval is $[0 2\pi]$.</p>
NormalizedFrequency	true	<p>Whether the frequency is normalized (<code>true</code>) or not (<code>false</code>). This property is set automatically at construction time based on <code>Fs</code>. If <code>Fs</code> is specified, <code>NormalizedFrequency</code> is set to <code>false</code>. See the <code>normalizefreq</code> method in <code>dspdata</code> for information on changing this property.</p>

`Hmss = dspdata.msspectrum(Data, Frequencies)` uses the mean-square spectrum data contained in `Data` and `Frequencies` vectors.

`Hmss = dspdata.msspectrum(..., 'Fs', Fs)` uses the sampling frequency `Fs`. Specifying `Fs` uses a default set of linear frequencies (in Hz) based on `Fs` and sets `NormalizedFrequency` to `false`.

`Hmss = dspdata.msspectrum(..., 'SpectrumType', SpectrumType)` uses `SpectrumType` to specify the interval over which the mean-square spectrum was calculated. For data that ranges from $[0 \pi]$ or $[0 \pi]$, set the `SpectrumType` to `onesided`; for data that ranges from $[0 2\pi]$, set the `SpectrumType` to `twosided`.

`Hmss = dspdata.msspectrum(..., 'CenterDC', flag)` uses the value of `flag` to indicate whether the zero-frequency (DC) component is centered. If `flag` is `true`, it indicates that the DC component is in the center of the two-sided spectrum. Set the `flag` to `false` if the DC component is on the left edge of the spectrum.

Methods

Methods provide ways of performing functions directly on your `dspdata` object without having to specify the parameters again. You can apply a method directly on the variable

you assigned to your `dspdata.msspectrum` object. You can use the following methods with a `dspdata.msspectrum` object.

- `centerdc`
- `normalizefreq`
- `onesided`
- `plot`
- `sfdr`
- `twosided`

For example, to normalize the frequency and set the `NormalizedFrequency` parameter to `true`, use

```
Hmss = normalizefreq(Hs)
```

For detailed information on using the methods and plotting the spectrum, see the `dspdata` reference page.

Examples

Mean-Square Spectrum of Sinusoids

Create a signal consisting of two sinusoids in additive noise.

```
Fs = 32e3;  
t = 0:1/Fs:1-1/Fs;  
x = cos(2*pi*t*1.24e3)+cos(2*pi*t*10e3)+randn(size(t));
```

Compute the one-sided PSD estimate of the signal. Use the result to construct a `dspdata` object. Plot the mean-square spectrum.

```
P = periodogram(x,[],[],Fs);  
Hmss = dspdata.msspectrum(P,'Fs',Fs,'spectrumtype','onesided');  
plot(Hmss)
```

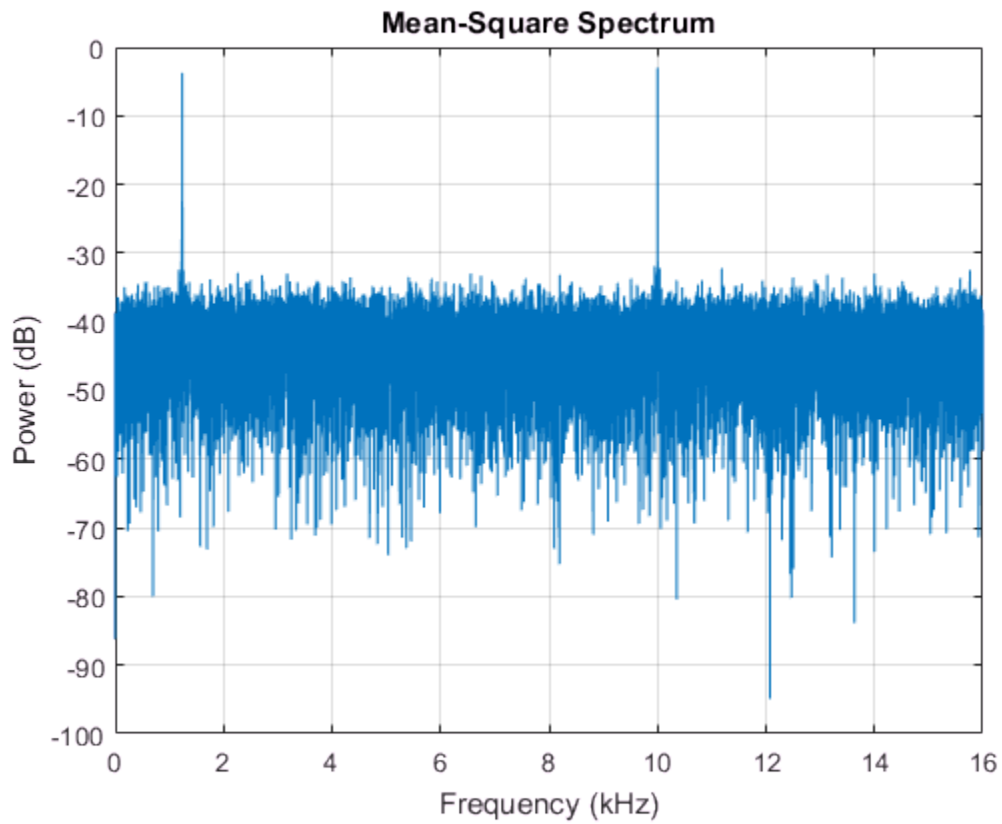

See Also

`periodogram` | `pwelch`

Introduced before R2006a

dspdata.psd

Power spectral density

Syntax

```
Hpsd = dspdata.psd(Data)
Hpsd = dspdata.psd(Data, Frequencies)
Hpsd = dspdata.psd(..., 'Fs', Fs)
Hpsd = dspdata.psd(..., 'SpectrumType', SpectrumType)
Hpsd = dspdata.psd(..., 'CenterDC', flag)
```

Description

Note: The use of `dspdata.psd` is not recommended. Use `pburg`, `pcov`, `periodogram`, `pmtm`, `pwelch`, or `pyulear` instead.

The power spectral density (PSD) is intended for continuous spectra. The integral of the PSD over a given frequency band computes the average power in the signal over that frequency band. In contrast to the mean-squared spectrum, the peaks in this spectra do not reflect the power at a given frequency. See the `avgpower` method of `dspdata` for more information.

A one-sided PSD contains the total power of the signal in the frequency interval from DC to half of the Nyquist rate. A two-sided PSD contains the total power in the frequency interval from DC to the Nyquist rate.

`Hpsd = dspdata.psd(Data)` uses the power spectral density data contained in `Data`, which can be in the form of a vector or a matrix, where each column is a separate set of data. Default values for other properties of the object are shown below:

Property	Default Value	Description
Name	'Power Spectral Density'	Read-only character vector

Property	Default Value	Description
Frequencies	[] type double	<p>Vector of frequencies at which the power spectral density is evaluated. The range of this vector depends on the SpectrumType value. For one-sided, the default range is $[0, \pi]$ or $[0, Fs/2)$ for odd length, and $[0, \pi]$ or $[0, Fs/2]$ for even length, if Fs is specified. For two-sided, it is $[0, 2\pi)$ or $[0, Fs)$.</p> <p>If you do not specify Frequencies, a default vector is created. If one-sided is selected, then the whole number of FFT points (nFFT) for this vector is assumed to be even.</p> <p>If onesided is selected and you specify Frequencies, the last frequency point is compared to the next-to-last point and to π (or $Fs/2$, if Fs is specified). If the last point is closer to π (or $Fs/2$) than it is to the previous point, nFFT is assumed to be even. If it is closer to the previous point, nFFT is assumed to be odd.</p> <p>The length of the Frequencies vector must match the length of the columns of Data.</p>
Fs	'Normalized '	<p>Sampling frequency, which is 'Normalized' if NormalizedFrequency is true. If NormalizedFrequency is false Fs defaults to 1.</p>

Property	Default Value	Description
SpectrumType	'Onesided'	<p>Nyquist interval over which the power spectral density is calculated. Valid values are 'Onesided' and 'Twosided'. A one-sided PSD contains the total signal power in half the Nyquist interval. See the <code>onesided</code> and <code>twosided</code> methods in <code>dspdata</code> for information on changing this property.</p> <p>The range for half the Nyquist interval is $[0 \pi)$ or $[0 \pi]$ depending on the number of FFT points. For the whole Nyquist interval, the range is $[0 2\pi)$.</p>
NormalizedFrequency	true	<p>Whether the frequency is normalized (<code>true</code>) or not (<code>false</code>). This property is set automatically at construction time based on <code>Fs</code>. If <code>Fs</code> is specified, <code>NormalizedFrequency</code> is set to <code>false</code>. See the <code>normalizefreq</code> method in <code>dspdata</code> for information on changing this property.</p>

`Hpsd = dspdata.psd(Data, Frequencies)` uses the power spectral density estimation data contained in `Data` and `Frequencies` vectors.

`Hpsd = dspdata.psd(..., 'Fs', Fs)` uses the sampling frequency `Fs`. Specifying `Fs` uses a default set of linear frequencies (in Hz) based on `Fs` and sets `NormalizedFrequency` to `false`.

`Hpsd = dspdata.psd(..., 'SpectrumType', SpectrumType)` specifies the interval over which the power spectral density is calculated. For data that ranges from $[0 \pi)$ or $[0 \pi]$, set the `SpectrumType` to `onesided`; for data that ranges from $[0 2\pi)$, set the `SpectrumType` to `twosided`.

`Hpsd = dspdata.psd(..., 'CenterDC', flag)` uses the value of `flag` to indicate whether the zero-frequency (DC) component is centered. If `flag` is `true`, it indicates that the DC component is in the center of the two-sided spectrum. Set the `flag` to `false` if the DC component is on the left edge of the spectrum.

Methods

Methods provide ways of performing functions directly on your `dspdata` object. You can apply a method directly on the variable you assigned to your `dspdata.psd` object. You can use the following methods with a `dspdata.psd` object.

- `avgpower`
- `centerdc`
- `normalizefreq`
- `onesided`
- `plot`
- `twosided`

For example, to normalize the frequency and set the `NormalizedFrequency` parameter to `true`, use

```
Hpsd = normalizefreq(Hpsd)
```

For detailed information on using the methods and plotting the spectrum, see the `dspdata` reference page.

Examples

Resolve Signal Components

Estimate the one-sided power spectral density of a noisy sinusoidal signal with two frequency components.

```
Fs = 32e3;  
t = 0:1/Fs:2.96;  
x = cos(2*pi*t*1.24e3) + cos(2*pi*t*10e3) + randn(size(t));  
nfft = 2^nextpow2(length(x));  
Pxx = abs(fft(x,nfft)).^2/length(x)/Fs;
```

Store the spectrum in a PSD data object and plot the result.

```
Hpsd = dspdata.psd(Pxx(1:length(Pxx)/2), 'Fs', Fs);  
plot(Hpsd)
```

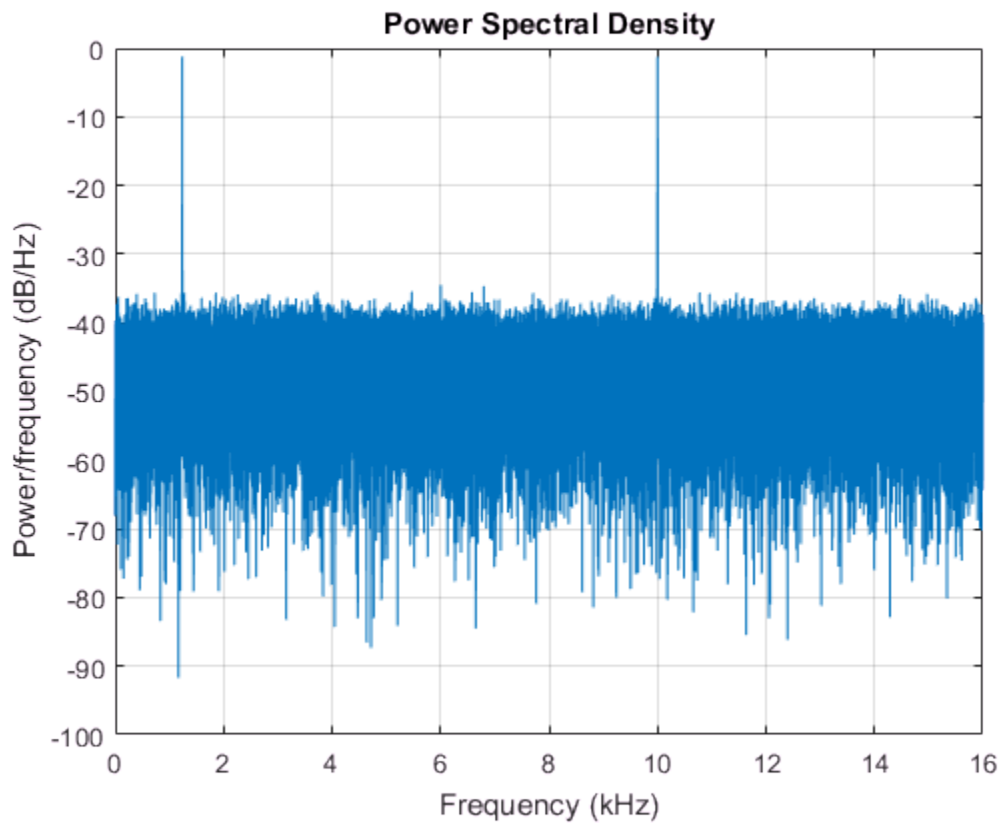

Create a two-sided spectrum and plot it.

```
Hpsd = dspdata.psd(Pxx, 'Fs', Fs, 'SpectrumType', 'twosided');  
plot(Hpsd)
```

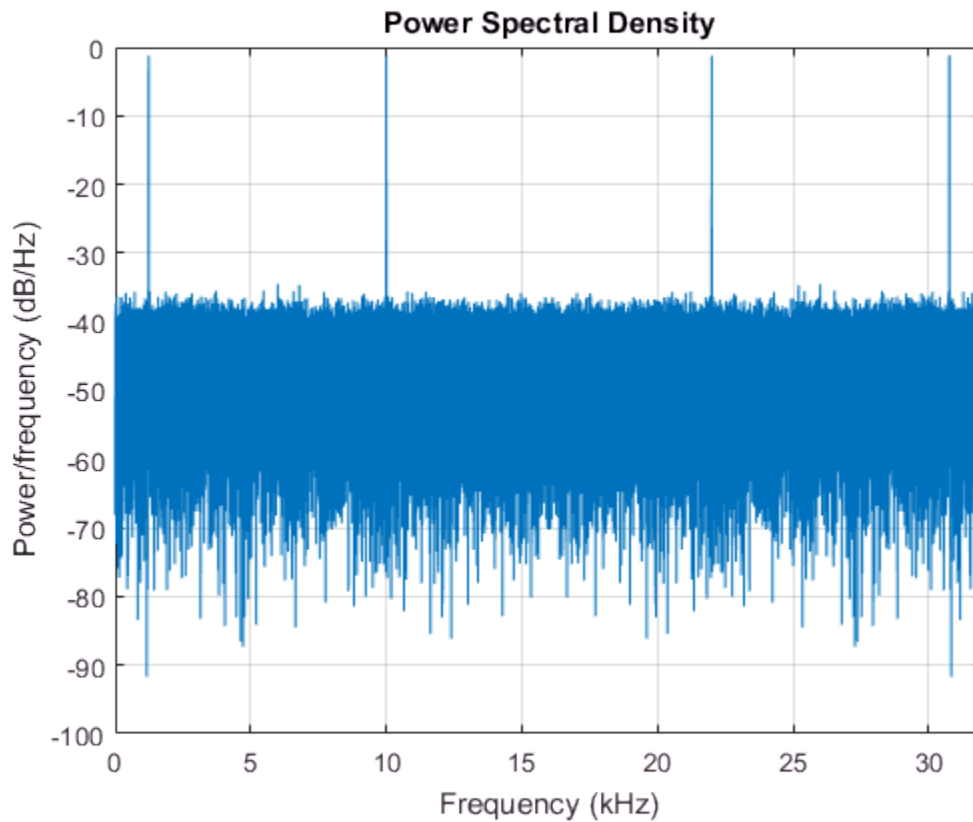

See Also

`pburg` | `pcov` | `periodogram` | `pmcov` | `pmtm` | `pwelch` | `pyulear`

Introduced before R2006a

dspdata.pseudospectrum

Pseudospectrum dspdata object

Syntax

```
Hps = dspdata.pseudospectrum(Data)
Hps = dspdata.pseudospectrum(Data,Frequencies)
Hps = dspdata.pseudospectrum(...,'Fs',Fs)
Hps = dspdata.pseudospectrum(...,'SpectrumRange',SpectrumRange)
Hps = dspdata.pseudospectrum(...,'CenterDC',flag)
```

Description

Note: The use of `dspdata.pseudospectrum` is not recommended. Use `peig` or `pmusic` instead.

A pseudospectrum is an indicator of the presence of sinusoidal components in a signal.

`Hps = dspdata.pseudospectrum(Data)` uses the pseudospectrum data contained in `Data`, which can be in the form of a vector or a matrix, where each column is a separate set of data. Default values for other properties of the object are:

Property	Default Value	Description
Name	'Pseudospectrum'	Read-only character vector
Frequencies	[] type double	<p>Vector of frequencies at which the power spectral density is evaluated. The range of this vector depends on the SpectrumRange value. For half, the default range is $[0, \pi)$ or $[0, Fs/2)$ for odd length, and $[0, \pi]$ or $[0, Fs/2]$ for even length, if Fs is specified. For whole, it is $[0, 2\pi)$ or $[0, Fs)$.</p> <p>If you do not specify Frequencies, a default vector is created. If half the Nyquist range is selected, then the whole number of FFT points (nFFT) for this vector is assumed to be even.</p> <p>If half the Nyquist range is selected and you specify Frequencies, the last frequency point is compared to the next-to-last point and to π (or $Fs/2$, if Fs is specified). If the last point is closer to π (or $Fs/2$) than it is to the previous point, nFFT is assumed to be even. If it is closer to the previous point, nFFT is assumed to be odd.</p> <p>The length of the Frequencies vector must match the length of the columns of Data.</p>
Fs	'Normalized'	Sampling frequency, which is 'Normalized' if NormalizedFrequency is true. If NormalizedFrequency is false Fs defaults to 1.

Property	Default Value	Description
SpectrumRange	'Half'	<p>Nyquist interval over which the pseudospectrum is calculated. Valid values are 'Half' and 'Whole'. See the <code>half</code> and <code>whole</code> methods in <code>dspdata</code> for information on changing this property.</p> <p>The interval for <code>Half</code> is $[0 \pi)$ or $[0 \pi]$ depending on the number of FFT points, and for <code>Whole</code> the interval is $[0 2\pi)$.</p>
NormalizedFrequency	true	<p>Whether the frequency is normalized (<code>true</code>) or not (<code>false</code>). This property is set automatically at construction time based on <code>Fs</code>. If <code>Fs</code> is specified, <code>NormalizedFrequency</code> is set to <code>false</code>. See the <code>normalizefreq</code> method in <code>dspdata</code> for information on changing this property.</p>

`Hps = dspdata.pseudospectrum(Data, Frequencies)` uses the pseudospectrum estimation data contained in the `Data` and `Frequencies` vectors.

`Hps = dspdata.pseudospectrum(..., 'Fs', Fs)` uses the sampling frequency `Fs`. Specifying `Fs` uses a default set of linear frequencies (in Hz) based on `Fs` and sets `NormalizedFrequency` to `false`.

`Hps = dspdata.pseudospectrum(..., 'SpectrumRange', SpectrumRange)` uses the `SpectrumRange` argument to specify the interval over which the pseudospectrum was calculated. For data that ranges from $[0 \pi)$ or $[0 \pi]$, set the `SpectrumRange` to `half`; for data that ranges from $[0 2\pi)$, set the `SpectrumRange` to `whole`.

`Hps = dspdata.pseudospectrum(..., 'CenterDC', flag)` uses the value of `flag` to indicate whether the zero-frequency (DC) component is centered. If `flag` is `true`, it indicates that the DC component is in the center of the whole Nyquist range spectrum. Set the `flag` to `false` if the DC component is on the left edge of the spectrum.

Methods

Methods provide ways of performing functions directly on your `dspdata` object. You can apply a method directly on the variable you assigned to your

`dspdata.pseudospectrum` object. You can use the following methods with a `dspdata.pseudospectrum` object.

- `centerdc`
- `halfrange`
- `normalizefreq`
- `plot`
- `wholerange`

For example, to normalize the frequency and set the `NormalizedFrequency` parameter to true, use

```
Hps = normalizefreq(Hps)
```

For detailed information on using the methods and plotting the pseudospectrum, see the `dspdata` reference page.

Examples

Store and Plot Pseudospectrum Data

Use eigenanalysis to estimate the pseudospectrum of a noisy sinusoidal signal with two frequency components.

```
Fs = 32e3;  
t = 0:1/Fs:2.96;  
x = cos(2*pi*t*1.24e3) + cos(2*pi*t*10e3) + randn(size(t));  
P = pmusic(x,4);
```

Create a pseudospectrum data object to store the results. Plot the pseudospectrum.

```
hps = dspdata.pseudospectrum(P, 'Fs', Fs);  
plot(hps)
```

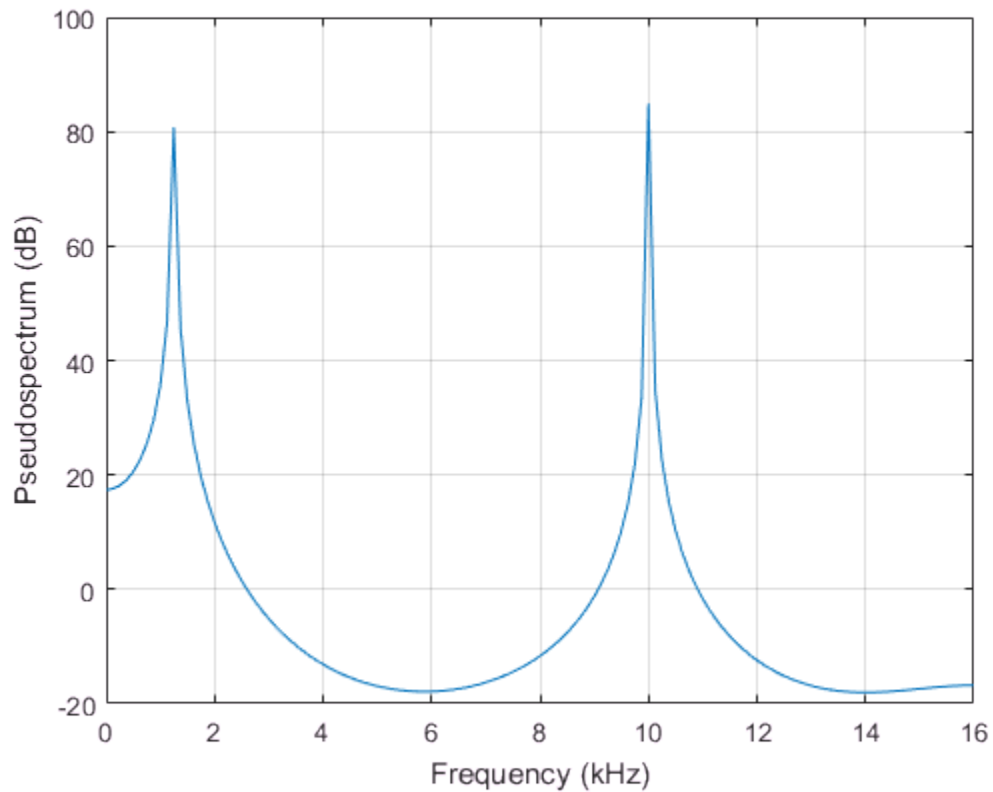

See Also

`peig` | `pmusic`

Introduced before R2006a

dspfwiz

Create Simulink filter block using Realize Model panel

Syntax

dspfwiz

Description

Note You must have the Simulink product installed to use this function.

dspfwiz opens Filter Designer with the Realize Model panel displayed.

Use other panels in Filter Designer to design your filter and then use the Realize Model panel to create your filter as a subsystem block, which is a combination of Sum, Gain, and Delay blocks, in a Simulink model.

If you also have the DSP System Toolbox software installed, you can create a Biquad Filter block or a Discrete FIR Filter block instead of a subsystem block, by deselecting the **Build model using basic elements** check box.

See Also

See Also

Apps

Filter Designer

Functions

dfilt

Introduced before R2006a

dtw

Distance between signals using dynamic time warping

Syntax

```
dist = dtw(x,y)
[dist,ix,iy] = dtw(x,y)

[ ___ ] = dtw(x,y,maxsamp)
[ ___ ] = dtw( ___,metric)

dtw( ___ )
```

Description

`dist = dtw(x,y)` stretches two vectors, `x` and `y`, onto a common set of instants such that `dist`, the sum of the Euclidean distances between corresponding points, is smallest. To stretch the inputs, `dtw` repeats each element of `x` and `y` as many times as necessary. If `x` and `y` are matrices, then `dist` stretches them by repeating their columns. In that case, `x` and `y` must have the same number of rows.

`[dist,ix,iy] = dtw(x,y)` returns the common set of instants, or *warping path*, such that `x(ix)` and `y(iy)` have the smallest possible `dist` between them.

The vectors `ix` and `iy` have the same length. Each contains a monotonically increasing sequence in which the indices to the elements of the corresponding signal, `x` or `y`, are repeated the necessary number of times.

When `x` and `y` are matrices, `ix` and `iy` are such that `x(:,ix)` and `y(:,iy)` are minimally separated.

`[___] = dtw(x,y,maxsamp)` restricts the warping path to be within `maxsamp` samples of a straight-line fit between `x` and `y`. This syntax returns any of the output arguments of previous syntaxes.

[___] = dtw(___, metric) specifies the distance metric to use in addition to any of the input arguments in previous syntaxes.

dtw(___) without output arguments plots the original and aligned signals.

- If the signals are real vectors, then the function displays the two original signals on a subplot and the aligned signals in a subplot below the first one.
- If the signals are complex vectors, then the function displays the original and aligned signals in three-dimensional plots.
- If the signals are real matrices, then the function displays the original and aligned signals as images.
- If the signals are complex matrices, then their real and imaginary portions appear in the top and bottom half of each image.

Examples

Dynamic Time Warping of Chirp and Sinusoid

Generate two real signals: a chirp and a sinusoid.

```
x = cos(2*pi*(3*(1:1000)/1000).^2);  
y = cos(2*pi*9*(1:399)/400);
```

Use dynamic time warping to align the signals such that the sum of the Euclidean distances between their points is smallest. Display the aligned signals and the distance.

```
dtw(x,y);
```

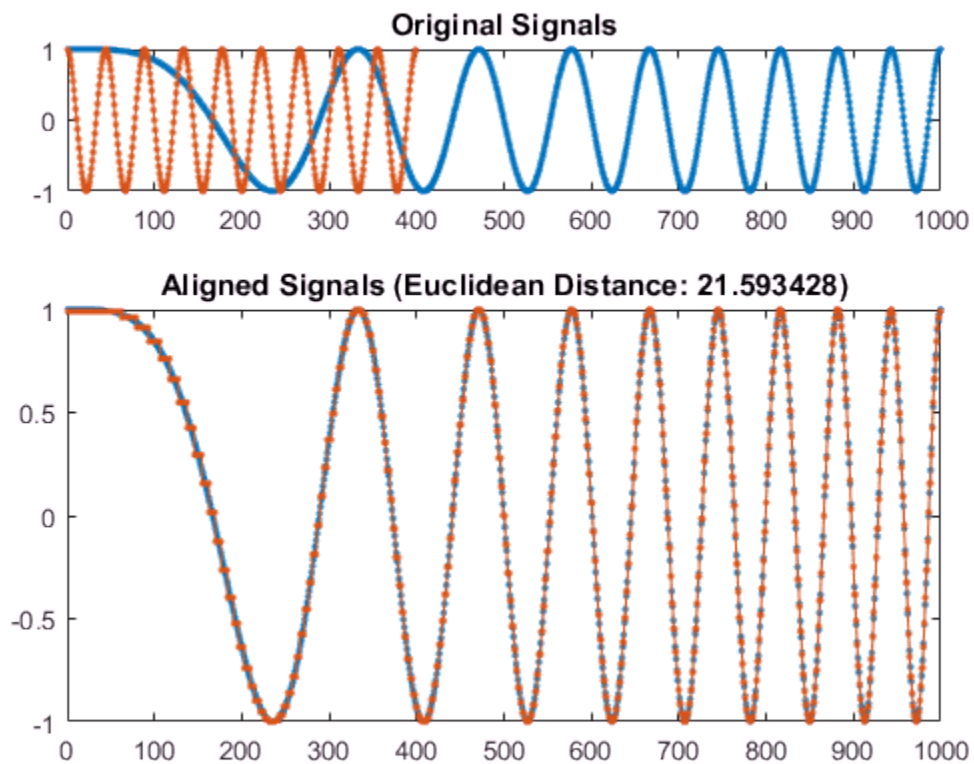

Change the sinusoid frequency to twice its initial value. Repeat the computation.

```
y = cos(2*pi*18*(1:399)/400);
```

```
dtw(x,y);
```

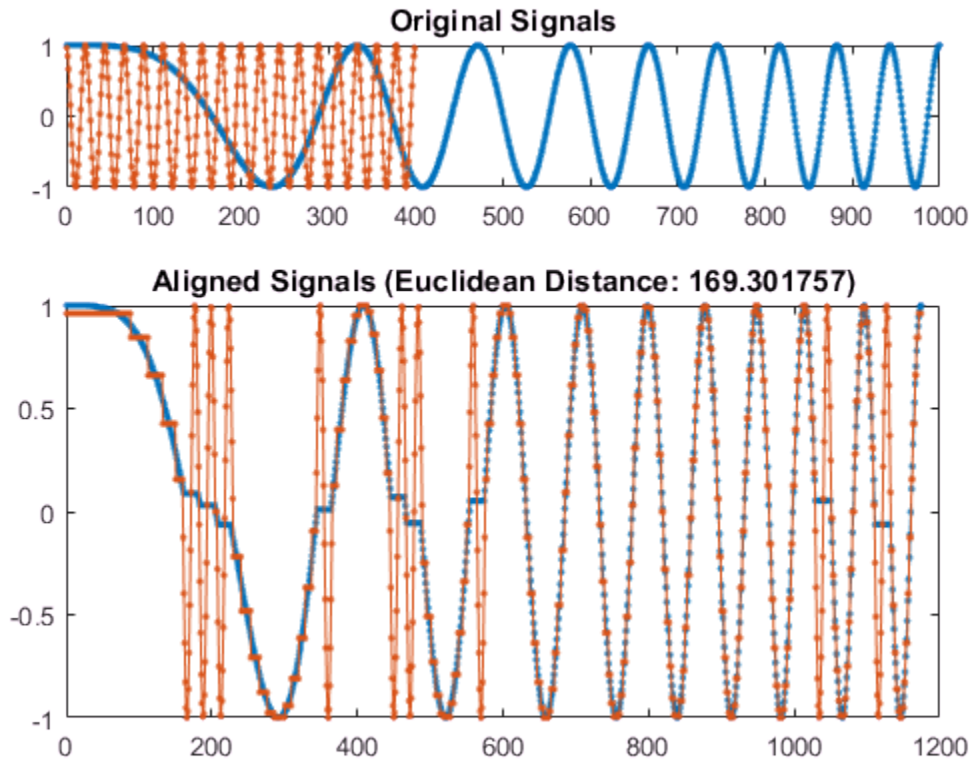

Add an imaginary part to each signal. Restore the initial sinusoid frequency. Use dynamic time warping to align the signals by minimizing the sum of squared Euclidean distances.

```
x = exp(2i*pi*(3*(1:1000)/1000).^2);
y = exp(2i*pi*9*(1:399)/400);

dtw(x,y, 'squared');
```

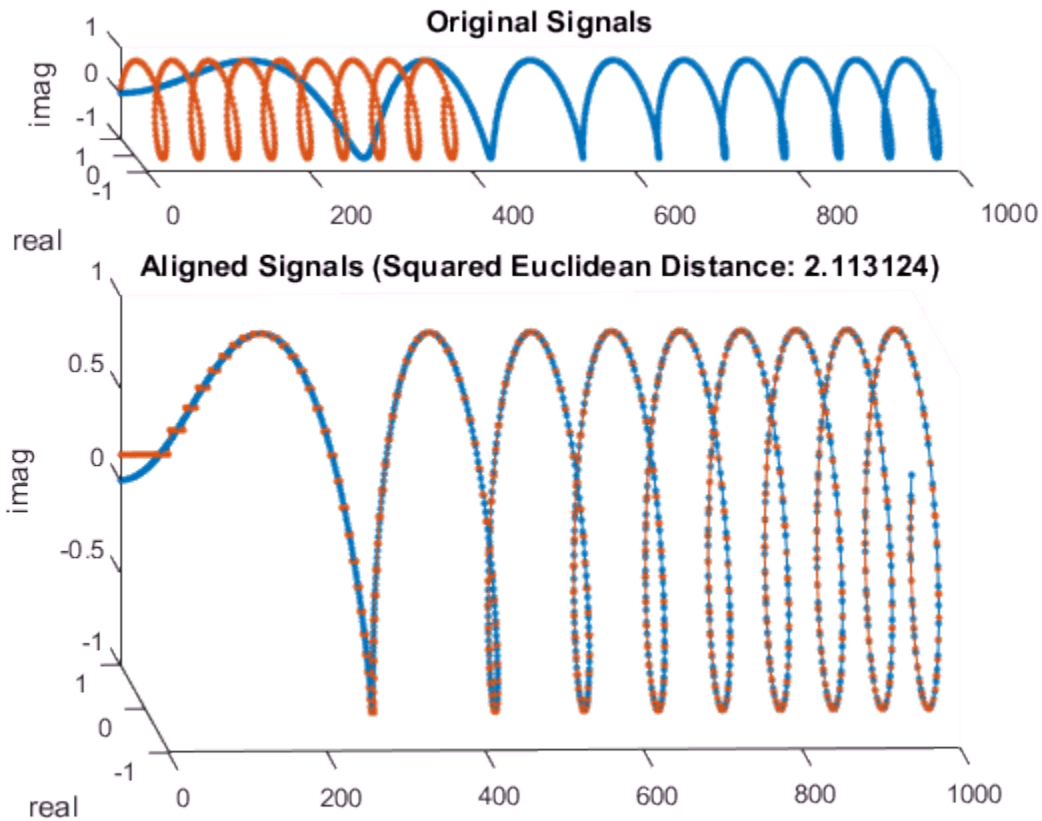

Align Writing Samples

Devise a typeface that resembles the output of early computers. Use it to write the word MATLAB®.

```
chr = @(x)dec2bin(x')-48;

M = chr([34 34 54 42 34 34 34]);
A = chr([08 20 34 34 62 34 34]);
T = chr([62 08 08 08 08 08 08]);
L = chr([32 32 32 32 32 32 62]);
B = chr([60 34 34 60 34 34 60]);
```

```
MATLAB = [M A T L A B];
```

Corrupt the word by repeating random columns of the letters and varying the spacing. Show the original word and three corrupted versions. Reset the random number generator for reproducible results.

```
rng('default')

c = @(x)x(:,sort([1:6 randi(6,1,3)]));

subplot(4,1,1,'XLim',[0 60])
spy(MATLAB)
xlabel('')
ylabel('Original')

for kj = 2:4
    subplot(4,1,kj,'XLim',[0 60])
    spy([c(M) c(A) c(T) c(L) c(A) c(B)])
    xlabel('')
    ylabel('Corrupted')
end
```

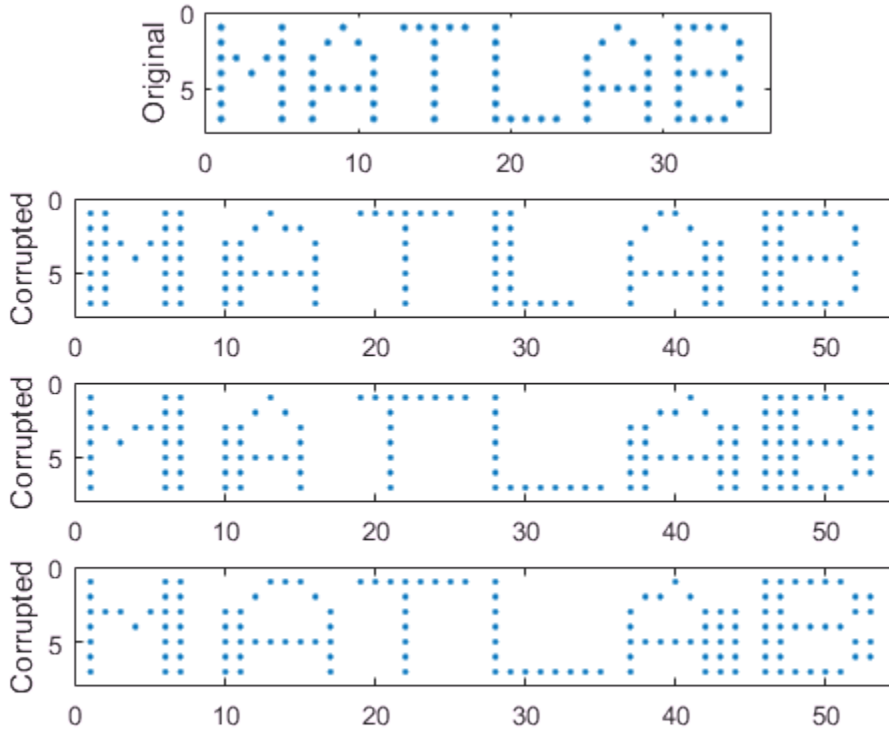

Generate two more corrupted versions of the word. Align them using dynamic time warping.

```
one = [c(M) c(A) c(T) c(L) c(A) c(B)];
two = [c(M) c(A) c(T) c(L) c(A) c(B)];

[ds,ix,iy] = dtw(one,two);

onewarp = one(:,ix);
twowarp = two(:,iy);
```

Display the unaligned and aligned words.

```
figure
```



```
subplot(4,1,1)
spy(one)
xlabel('')
ylabel('one')

subplot(4,1,2)
spy(two, 'r')
xlabel('')
ylabel('two')

subplot(4,1,3)
spy(onewarp)
xlabel('')
ylabel('onewarp')

subplot(4,1,4)
spy(twowarp, 'r')
xlabel('')
ylabel('twowarp')
```

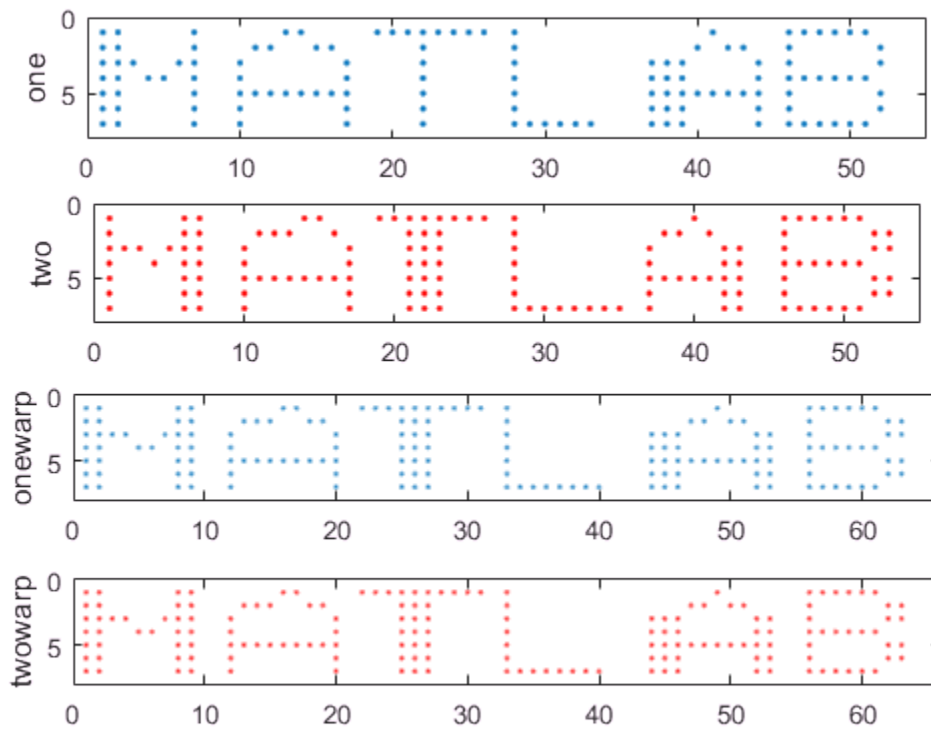

Repeat the computation using the built-in functionality of `dtw`.

```
dtw(one,two);
```

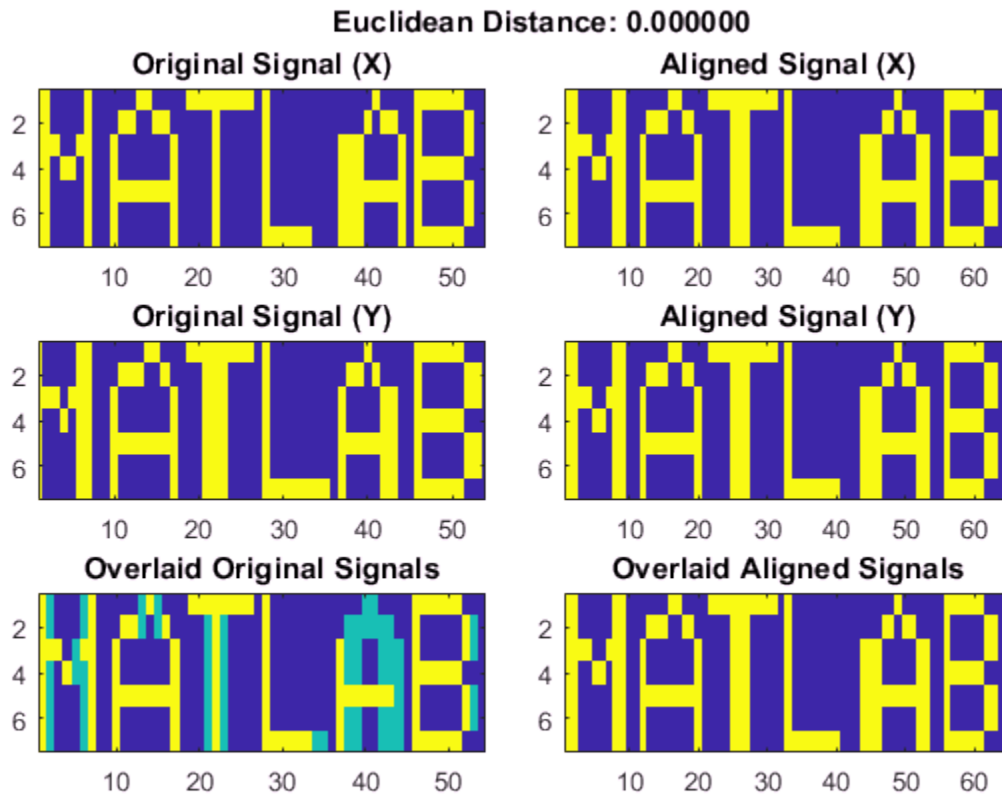

Constrained Warping Path

Generate two signals consisting of two distinct peaks separated by valleys of different lengths. Plot the signals.

```
x1 = [0 1 0 0 0 0 0 0 0 0 0 1 0]*.95;
x2 = [0 1 0 1 0]*.95;
```

```
subplot(2,1,1)
plot(x1)
x1 = xlim;
subplot(2,1,2)
```

```
plot(x2)  
xlim(x1)
```

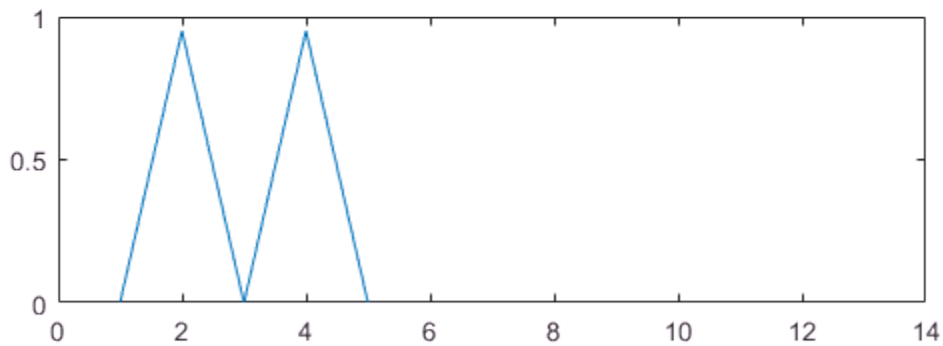
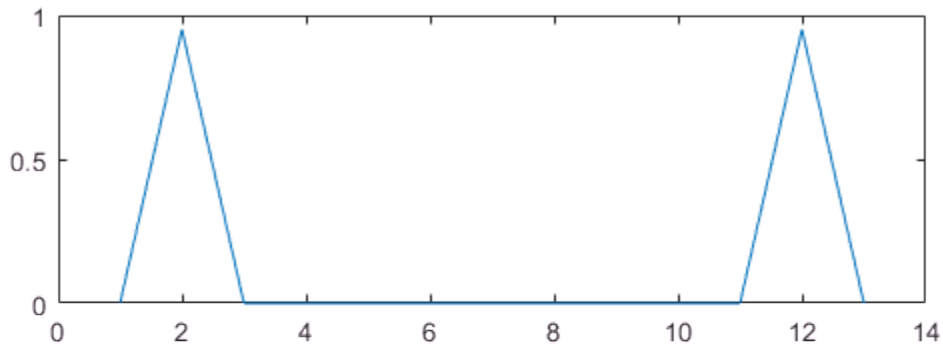

Align the signals with no restriction on the warping path. To produce perfect alignment, the function needs to repeat only one sample of the shorter signal.

```
figure  
dtw(x1,x2);
```

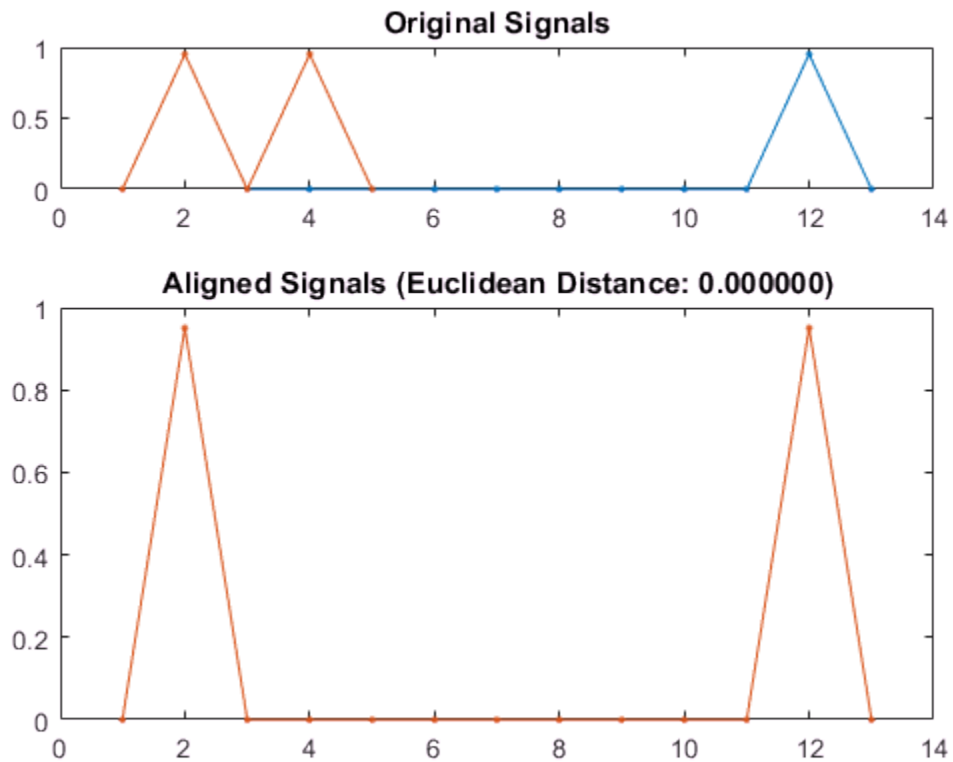

Plot the warping path and the straight-line fit between the two signals. To achieve alignment, the function expands the trough between the peaks generously.

```
[d,i1,i2] = dtw(x1,x2);
```

```
figure
plot(i1,i2,'o-',[i1(1) i1(end)],[i2(1) i2(end)])
```

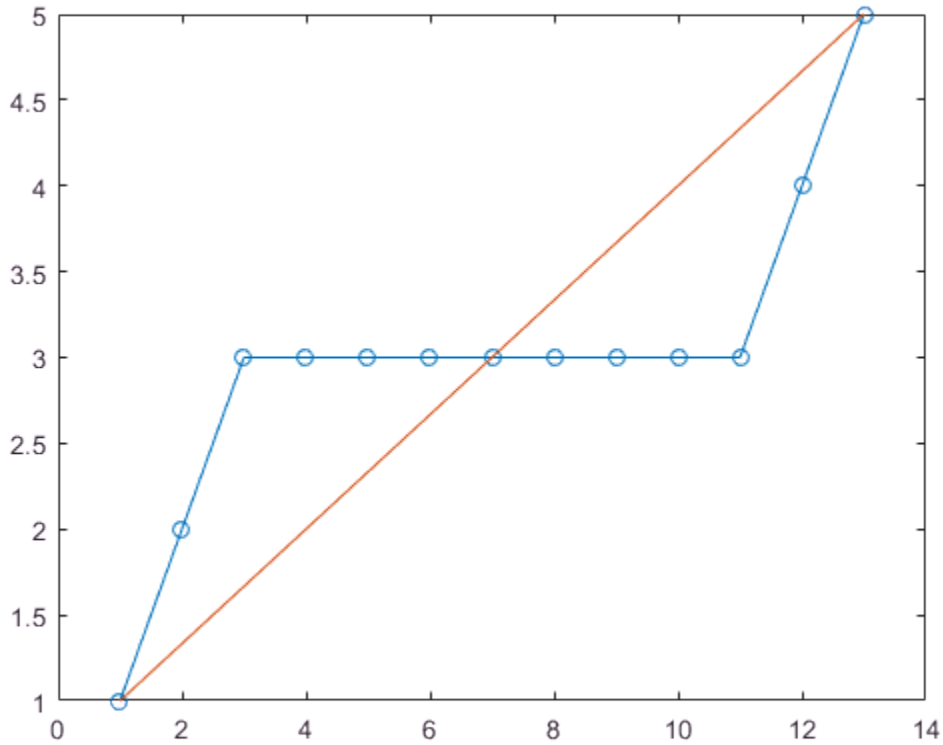

Repeat the computation, but now constrain the warping path to deviate at most three elements from the straight-line fit. Plot the stretched signals and the warping path.

```
[dc,i1c,i2c] = dtw(x1,x2,3);

subplot(2,1,1)
plot([x1(i1c);x2(i2c)]','.-')
title(['Distance: ' num2str(dc)])
subplot(2,1,2)
plot(i1c,i2c,'o-',[i1(1) i1(end)],[i2(1) i2(end)])
```

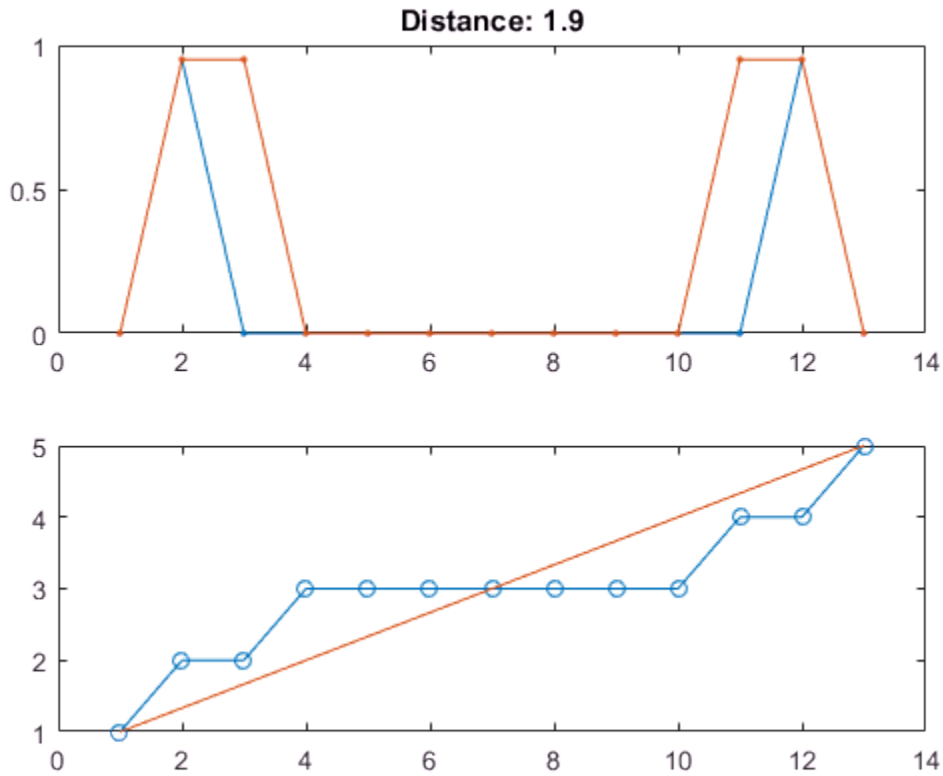

The constraint precludes the warping from concentrating too much on a small subset of samples, at the expense of alignment quality. Repeat the calculation with a one-sample constraint.

```
dtw(x1,x2,1);
```

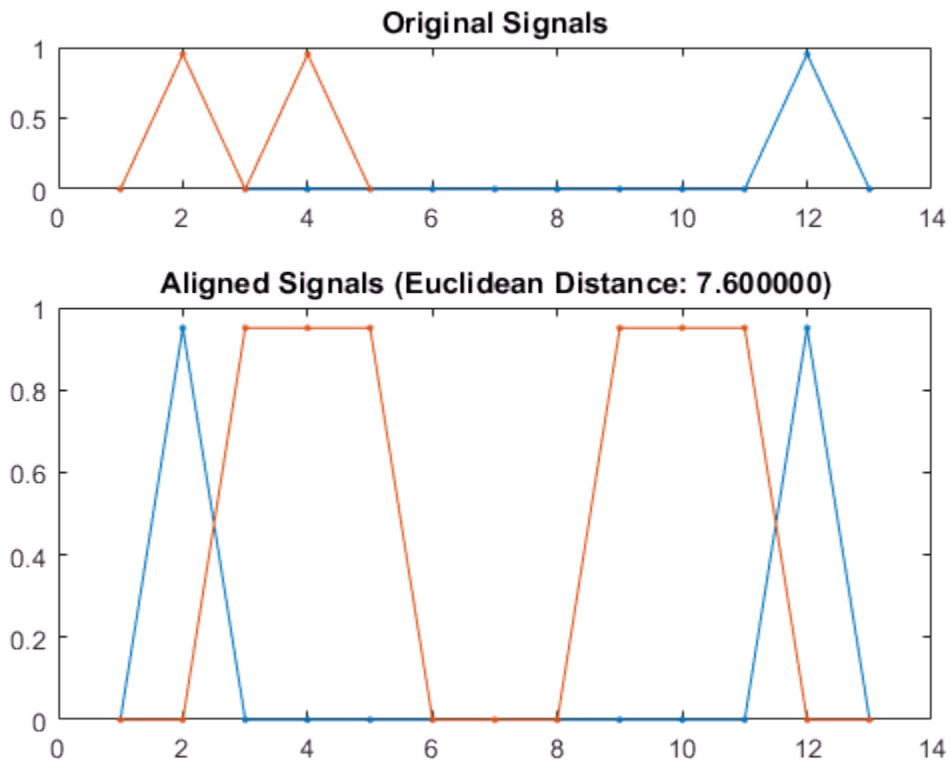

Dynamic Time Warping of Speech Signals

Load a speech signal sampled at $F_s = 7418$ Hz. The file contains a recording of a female voice saying the word "MATLAB®."

```
load mtlb
```

```
% To hear, type soundsc(mtlb,Fs)
```

Extract the two segments that correspond to the two instances of the /æ/ phoneme. The first one occurs roughly between 150 ms and 250 ms, and the second one between 370 ms and 450 ms. Plot the two waveforms.

```
a1 = mtlb(round(0.15*Fs):round(0.25*Fs));  
a2 = mtlb(round(0.37*Fs):round(0.45*Fs));  
  
subplot(2,1,1)  
plot((0: numel(a1)-1)/Fs+0.15,a1)  
title('a_1')  
subplot(2,1,2)  
plot((0: numel(a2)-1)/Fs+0.37,a2)  
title('a_2')  
xlabel('Time (seconds)')
```

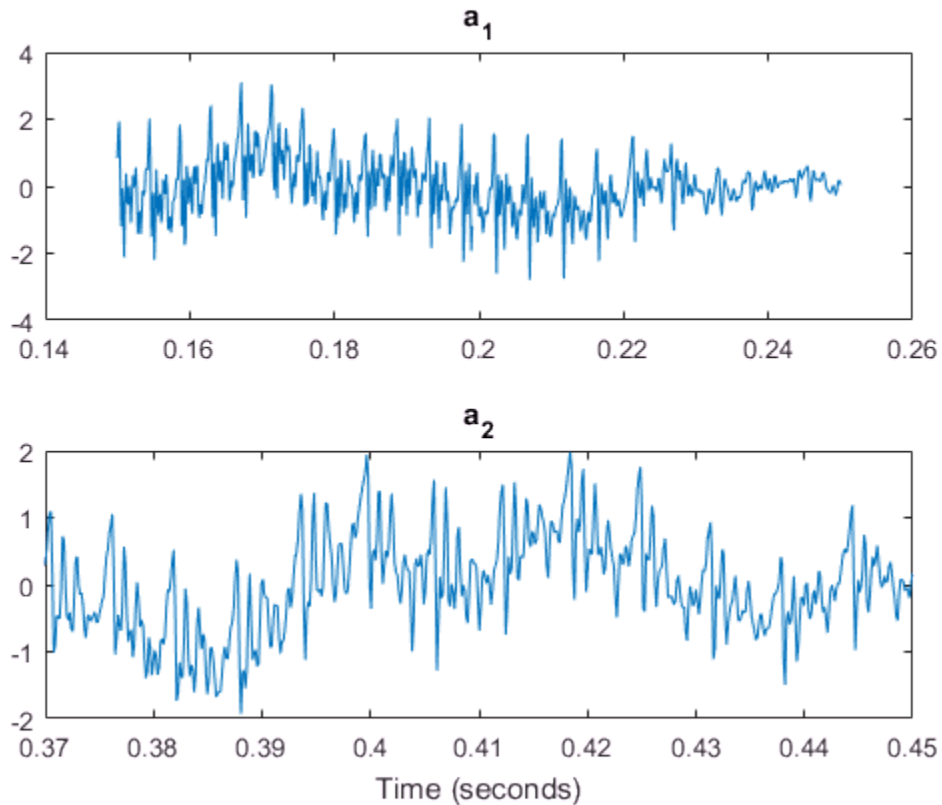

```
% To hear, type soundsc(a1,Fs), pause(1), soundsc(a2,Fs)
```

Warp the time axes so that the Euclidean distance between the signals is minimized. Compute the shared "duration" of the warped signals and plot them.

```
[d,i1,i2] = dtw(a1,a2);

a1w = a1(i1);
a2w = a2(i2);

t = (0:numel(i1)-1)/Fs;
duration = t(end)

duration = 0.1297

subplot(2,1,1)
plot(t,a1w)
title('a_1, Warped')
subplot(2,1,2)
plot(t,a2w)
title('a_2, Warped')
xlabel('Time (seconds)')
```

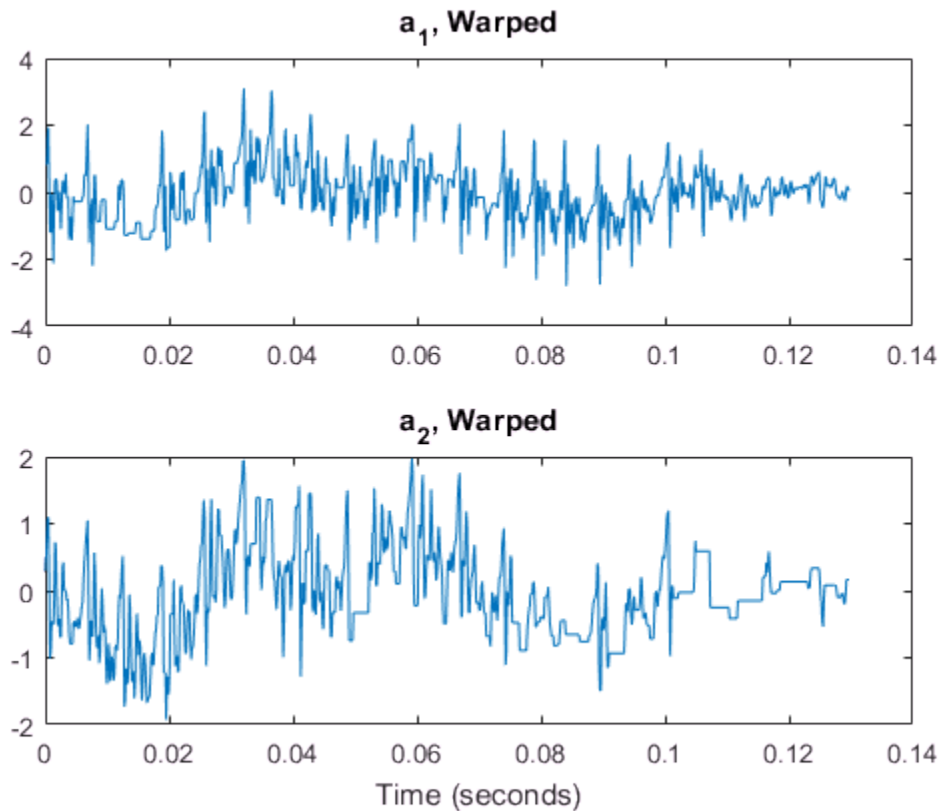

```
% To hear, type soundsc(a1w,Fs), pause(1), sound(a2w,Fs)
```

Repeat the experiment with a complete word. Load a file containing the word "strong," spoken by a woman and by a man. The signals are sampled at 8 kHz.

```
load(fullfile(matlabroot,'examples','signal','strong.mat'))
```

```
% To hear, type soundsc(her,fs), pause(2), soundsc(him,fs)
```

Warp the time axes so that the absolute distance between the signals is minimized. Plot the original and transformed signals. Compute their shared warped "duration."

```
dtw(her,him,'absolute');
legend('her','him')
```

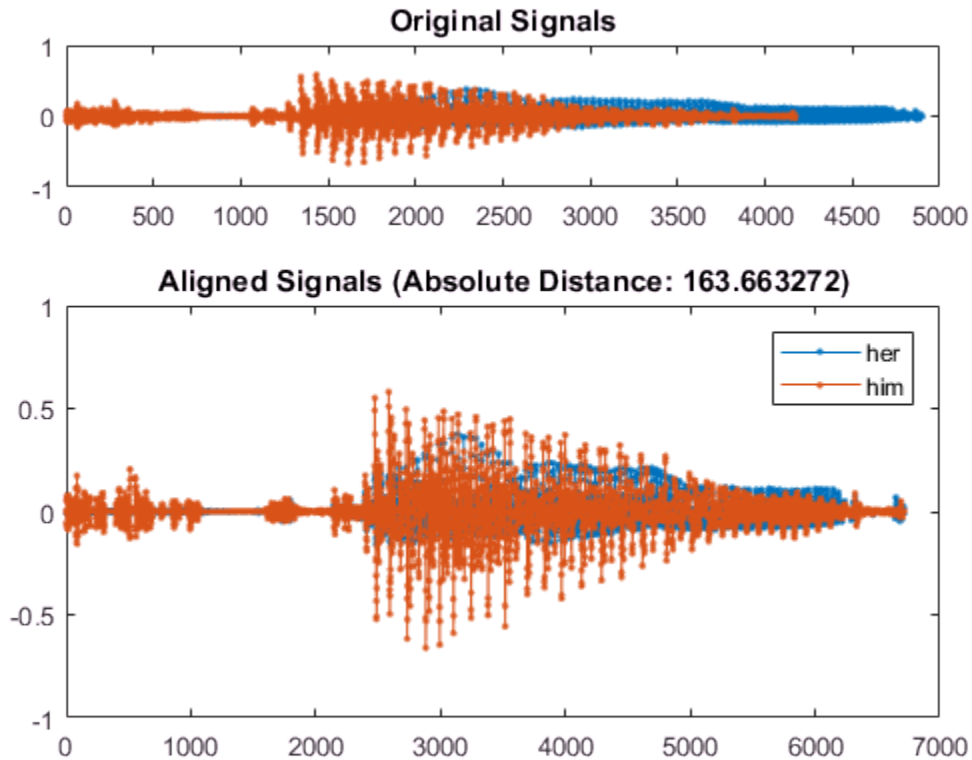

```
[d,iher,ihim] = dtw(her,him,'absolute');
duration = numel(iher)/fs
```

```
duration = 0.8394
```

```
% To hear, type soundsc(her(iher),fs), pause(2), soundsc(him(ihim),fs)
```

Dynamic Time Warping for Handwriting Alignment

The files `MATLAB1.gif` and `MATLAB2.gif` contain two handwritten samples of the word "MATLAB®." Load the files and align them along the x -axis using dynamic time warping.

```

samp1 = fullfile(matlabroot, 'examples', 'signal', 'MATLAB1.gif');
samp2 = fullfile(matlabroot, 'examples', 'signal', 'MATLAB2.gif');

x = double(imread(samp1));
y = double(imread(samp2));

dtw(x,y);

```

Euclidean Distance: 105656.932801

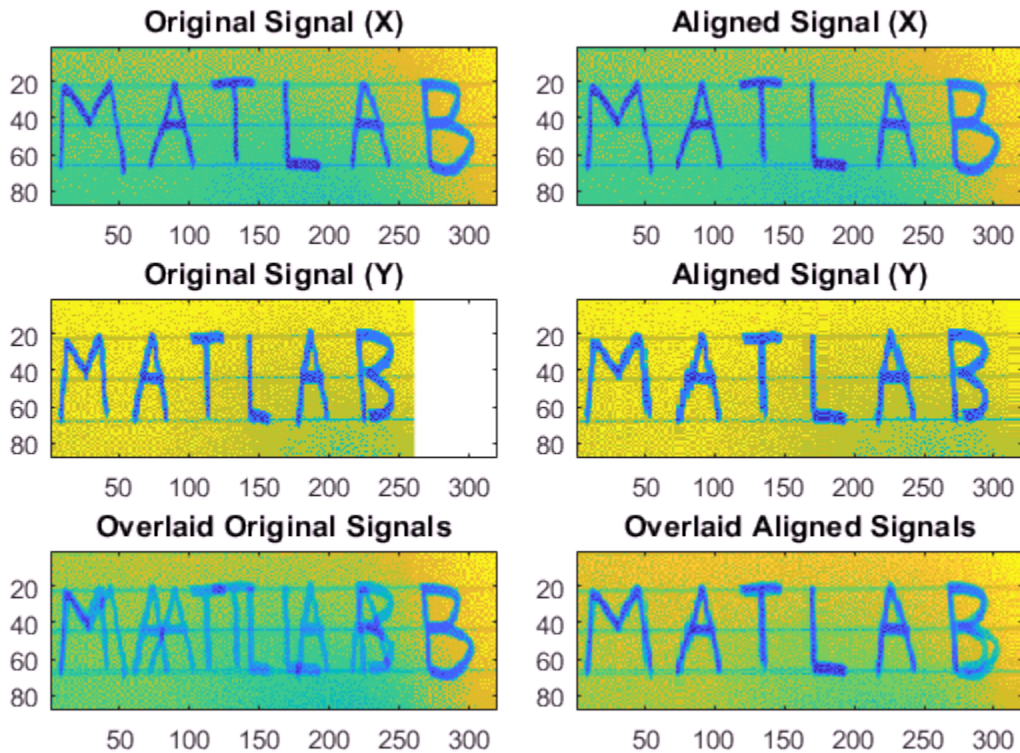

Input Arguments

x — Input signal
vector | matrix

Input signal, specified as a real or complex vector or matrix.

Data Types: `single` | `double`

Complex Number Support: Yes

y — Input signal

vector | matrix

Input signal, specified as a real or complex vector or matrix.

Data Types: `single` | `double`

Complex Number Support: Yes

maxsamp — Width of adjustment window

Inf (default) | positive integer

Width of adjustment window, specified as a positive integer.

Data Types: `single` | `double`

metric — Distance metric

'euclidean' (default) | 'absolute' | 'squared' | 'symmkl'

Distance metric, specified as 'euclidean', 'absolute', 'squared', or 'symmkl'. If **X** and **Y** are both *K*-dimensional signals, then **metric** prescribes $d_{mn}(\mathbf{X}, \mathbf{Y})$, the distance between the *m*th sample of **X** and the *n*th sample of **Y**. See “Dynamic Time Warping” on page 1-473 for more information about $d_{mn}(\mathbf{X}, \mathbf{Y})$.

- 'euclidean' — Root sum of squared differences, also known as the Euclidean or ℓ_2 metric:

$$d_{mn}(\mathbf{X}, \mathbf{Y}) = \sqrt{\sum_{k=1}^K (x_{k,m} - y_{k,n})^* (x_{k,m} - y_{k,n})}$$

- 'absolute' — Sum of absolute differences, also known as the Manhattan, city block, taxicab, or ℓ_1 metric:

$$d_{mn}(\mathbf{X}, \mathbf{Y}) = \sum_{k=1}^K |x_{k,m} - y_{k,n}| = \sum_{k=1}^K \sqrt{(x_{k,m} - y_{k,n})^* (x_{k,m} - y_{k,n})}$$

- 'squared' — Square of the Euclidean metric, consisting of the sum of squared differences:

$$d_{mn}(\mathbf{X}, \mathbf{Y}) = \sum_{k=1}^K (x_{k,m} - y_{k,n})^* (x_{k,m} - y_{k,n})$$

- 'symmk1' — Symmetric Kullback-Leibler metric. This metric is valid only for real and positive \mathbf{X} and \mathbf{Y} :

$$d_{mn}(\mathbf{X}, \mathbf{Y}) = \sum_{k=1}^K (x_{k,m} - y_{k,n}) (\log x_{k,m} - \log y_{k,n})$$

Data Types: char

Output Arguments

dist — Minimum distance

positive real scalar

Minimum distance between signals, returned as a positive real scalar.

ix — Warping path for first signal

vector of indices | matrix of indices

Warping path for first signal, returned as a vector or matrix of indices.

iy — Warping path for second signal

vector of indices | matrix of indices

Warping path for second signal, returned as a vector or matrix of indices.

Definitions

Dynamic Time Warping

Two signals with equivalent features arranged in the same order can appear very different due to differences in the durations of their sections. Dynamic time warping distorts these durations so that the corresponding features appear at the same location on a common time axis, thus highlighting the similarities between the signals.

Consider the two K -dimensional signals

$$\mathbf{X} = \begin{bmatrix} x_{1,1} & x_{1,2} & \cdots & x_{1,M} \\ x_{2,1} & x_{2,2} & \cdots & x_{2,M} \\ \vdots & \vdots & \ddots & \vdots \\ x_{K,1} & x_{K,2} & \cdots & x_{K,M} \end{bmatrix}$$

and

$$\mathbf{Y} = \begin{bmatrix} y_{1,1} & y_{1,2} & \cdots & y_{1,N} \\ y_{2,1} & y_{2,2} & \cdots & y_{2,N} \\ \vdots & \vdots & \ddots & \vdots \\ y_{K,1} & y_{K,2} & \cdots & y_{K,N} \end{bmatrix},$$

which have M and N samples, respectively. Given $d_{mn}(\mathbf{X}, \mathbf{Y})$, the distance between the m th sample of \mathbf{X} and the n th sample of \mathbf{Y} specified in `metric`, `dist` stretches \mathbf{X} and \mathbf{Y} onto a common set of instants such that a global signal-to-signal distance measure is smallest.

Initially, the function arranges all possible values of $d_{mn}(\mathbf{X}, \mathbf{Y})$ into a lattice of the form

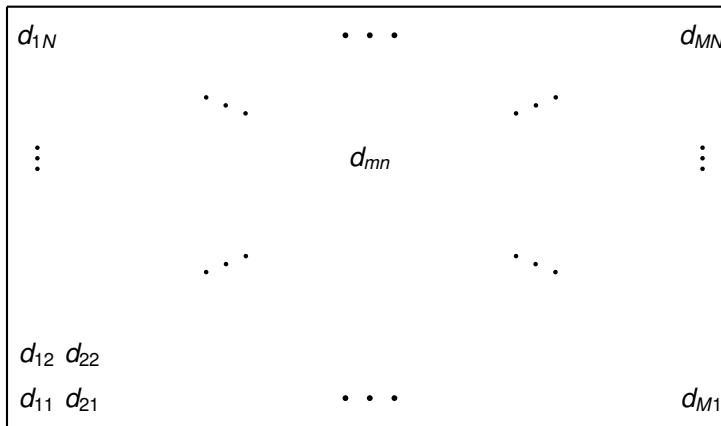

Then `dist` looks for a path through the lattice—parameterized by two sequences of the same length, `ix` and `iy`—such that

$$d = \sum_{\substack{m \in 1x \\ n \in 1y}} d_{mn}(\mathbf{X}, \mathbf{Y})$$

is minimum. Acceptable `dist` paths start at $d_{11}(\mathbf{X}, \mathbf{Y})$, end at $d_{MN}(\mathbf{X}, \mathbf{Y})$, and are combinations of “chess king” moves:

- Vertical moves: $(m, n) \rightarrow (m + 1, n)$
- Horizontal moves: $(m, n) \rightarrow (m, n + 1)$
- Diagonal moves: $(m, n) \rightarrow (m + 1, n + 1)$

This structure ensures that any acceptable path aligns the complete signals, does not skip samples, and does not repeat signal features. Additionally, a desirable path runs close to the diagonal line extended between $d_{11}(\mathbf{X}, \mathbf{Y})$ and $d_{MN}(\mathbf{X}, \mathbf{Y})$. This extra constraint, adjusted by the `maxsamp` argument, ensures that the warping compares sections of similar length and does not overfit outlier features.

This is a possible path through the lattice:

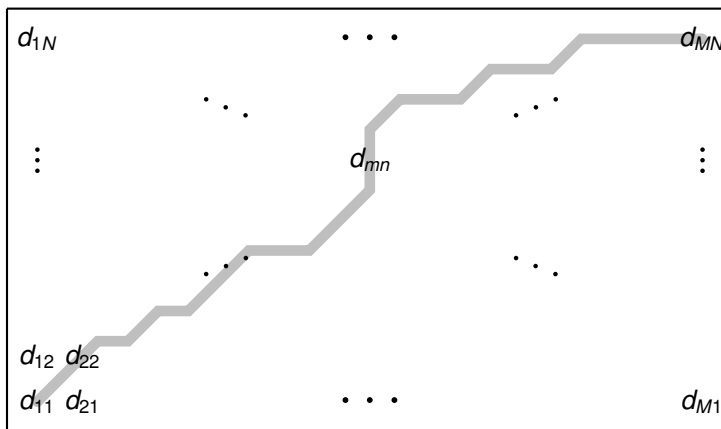

References

- [1] Sakoe, Hiroaki, and Seibi Chiba. “Dynamic Programming Algorithm Optimization for Spoken Word Recognition.” *IEEE Transactions on Acoustics, Speech, and Signal Processing*. Vol. ASSP-26, No.1, 1978, pp.43–49.

[2] Paliwal, K.K., Anant Agarwal, and Sarvjit S. Sinha. “A Modification over Sakoe and Chiba’s Dynamic Time Warping Algorithm for Isolated Word Recognition.” *Signal Processing*. Vol.4, 1982, pp.329–333.

See Also

See Also

`alignsignals` | `edr` | `finddelay` | `findsignal` | `xcorr`

Introduced in R2016a

dutyCycle

Duty cycle of pulse waveform

Syntax

```

D = dutyCycle(X)
D = dutyCycle(X,FS)
D = dutyCycle(X,T)
D = dutyCycle(TAU,PRF)
[D,INITCROSS] = dutyCycle(X,...)
[D,INITCROSS,FINALCROSS] = dutyCycle(X,...)
[D,INITCROSS,FINALCROSS,NEXTCROSS] = dutyCycle(X,...)
[D,INITCROSS,FINALCROSS,NEXTCROSS,MIDLEV] = dutyCycle(X,...)
[D,INITCROSS,FINALCROSS,NEXTCROSS] = dutyCycle(X,...,Name,Value)
dutyCycle(X,...)

```

Description

`D = dutyCycle(X)` returns the ratio of pulse width to pulse period for each positive-polarity pulse. `D` has length equal to the number of pulse periods in `X`. The sample instants of `X` correspond to the indices of `X`. To determine the transitions that define each pulse, `dutyCycle` estimates the state levels of the input waveform by a histogram method. `dutyCycle` identifies all regions, which cross the upper-state boundary of the low state and the lower-state boundary of the high state. The low-state and high-state boundaries are expressed as the state level plus or minus a multiple of the difference between the state levels. See “State-Level Tolerances” on page 1-486.

`D = dutyCycle(X,FS)` specifies the sampling frequency, `FS`, in hertz as a positive scalar. The first sample instant of `X` corresponds to $t=0$.

`D = dutyCycle(X,T)` specifies the sample instants, `T`, as a vector with the same number of elements as `X`.

`D = dutyCycle(TAU,PRF)` returns the ratio of pulse width to pulse period for a pulse width of `TAU` seconds and a pulse repetition frequency of `PRF`. The product of `TAU` and `PRF` must be less than or equal to 1.

`[D, INITCROSS] = dutycycle(X, ...)` returns a vector, `INITCROSS`, whose elements correspond to the mid-crossings (mid-reference level instants) of the initial transition of each pulse with a corresponding `NEXTCROSS`.

`[D, INITCROSS, FINALECROSS] = dutycycle(X, ...)` returns a vector, `FINALECROSS`, whose elements correspond to the mid-crossings (mid-reference level instants) of the final transition of each pulse with a corresponding `NEXTCROSS`.

`[D, INITCROSS, FINALECROSS, NEXTCROSS] = dutycycle(X, ...)` returns a vector, `NEXTCROSS`, whose elements correspond to the mid-crossings (mid-reference level instants) of the next detected transition for each pulse.

`[D, INITCROSS, FINALECROSS, NEXTCROSS, MIDLEV] = dutycycle(X, ...)` returns the mid-reference level, `MIDLEV`. Because in a bilevel pulse waveform the state levels are constant, `MIDLEV` is a scalar.

`[D, INITCROSS, FINALECROSS, NEXTCROSS] = dutycycle(X, ..., Name, Value)` returns the ratio of pulse width to pulse period with additional options specified by one or more `Name, Value` pair arguments.

`dutycycle(X, ...)` plots the waveform, `X`, and marks the location of the mid-reference level instants and the associated reference levels. The state levels and associated lower and upper state boundaries are also plotted.

Input Arguments

X

Bilevel waveform. `X` is a real-valued row or column vector.

FS

Sample rate in hertz.

T

Vector of sample instants. The length of `T` must equal the length of the bilevel waveform, `X`.

TAU

Pulse width in seconds. The product of `TAU` and `PRF` must be less than or equal to 1.

PRF

Pulse repetition frequency in pulses/second. The product of TAU and PRF must be less than or equal to 1.

Name-Value Pair Arguments**'MidPercentReferenceLevel'**

Mid-reference level as a percentage of the waveform amplitude.

Default: 50

'Polarity'

Pulse polarity. Specify the polarity as 'positive' or 'negative'. If you specify 'positive', `dutycycle` looks for pulses with positive-going (positive polarity) initial transitions. If you specify 'negative', `dutycycle` looks for pulses with negative-going (negative polarity) initial transitions. See “Pulse Polarity” on page 1-485 for examples of positive and negative-polarity pulses.

Default: 'positive'

'StateLevels'

Low- and high-state levels. `StateLevels` is a 1-by-2 real-valued vector. The first element is the low-state level. The second element is the high-state level. If you do not specify low- and high-state levels, `dutycycle` estimates the state levels from the input waveform using the histogram method.

'Tolerance'

Tolerance levels (lower- and upper-state boundaries) expressed as a percentage. See “State-Level Tolerances” on page 1-486.

Default: 2

Output Arguments**D**

Duty cycle. Duty cycle is the ratio of the pulse width to the pulse period. Because the pulse width cannot exceed the pulse period, $0 \leq D \leq 1$.

INITCROSS

Mid-reference level instant of initial transition. Because the duty cycle is defined as the ratio of pulse width to pulse period, initial transitions are only reported when `dutycycle` finds a corresponding `NEXTCROSS`.

FINALCROSS

Mid-reference level instant of final transition. The duty cycle is defined as the ratio of pulse width to pulse period. Thus, final transitions are only reported when `dutycycle` finds a corresponding `NEXTCROSS`.

NEXTCROSS

Mid-reference level instant of the first initial transition after the final transition of the preceding pulse.

MIDLEV

Mid-reference level. The waveform value that corresponds to the mid-reference level.

Examples

Duty Cycle of Bilevel Waveform

Determine the duty cycle of a bilevel waveform. Use the vector indices as the sample instants.

```
load('pulseex.mat','x')
```

```
d = dutycycle(x)
```

```
d = 0.3001
```

Annotate the result on a plot of the waveform.

```
dutycycle(x);
```

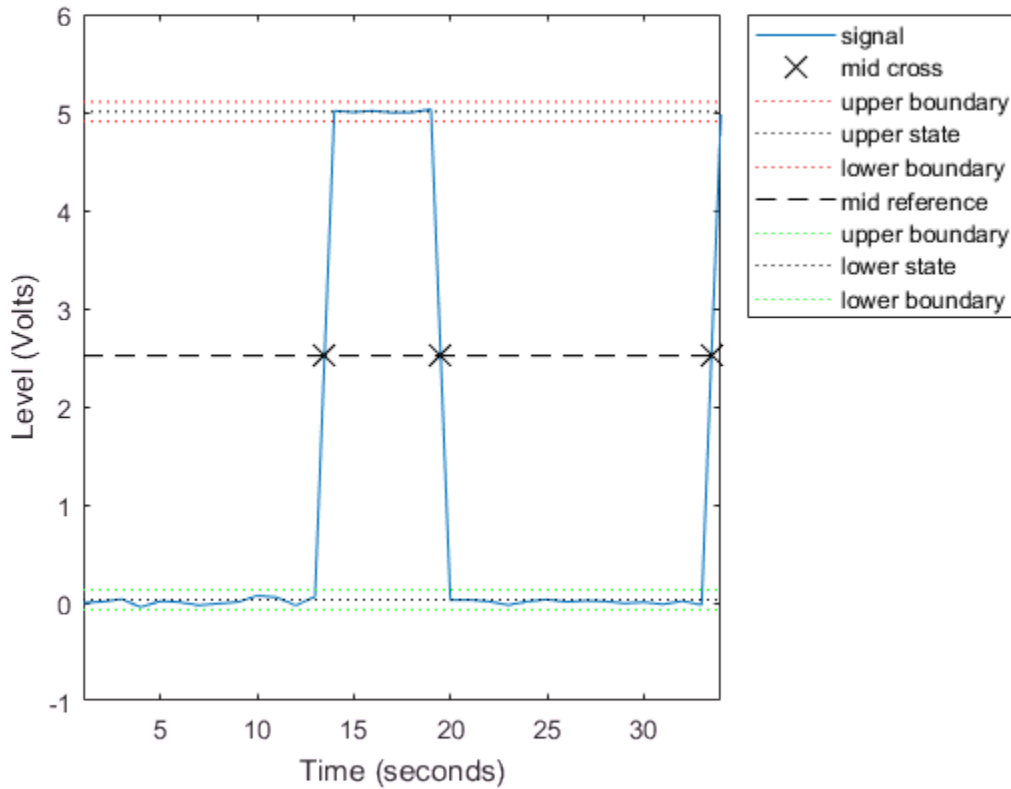

Duty Cycle of Bilevel Waveform with Sample Rate

Determine the duty cycle of a bilevel waveform. The sample rate is 4 MHz.

```
load('pulseex.mat','x','t')
fs = 1/(t(2)-t(1));
```

```
d = dutycycle(x,fs)
```

```
d = 0.3001
```

Annotate the result on a plot of the waveform.

```
dutycycle(x,fs);
```

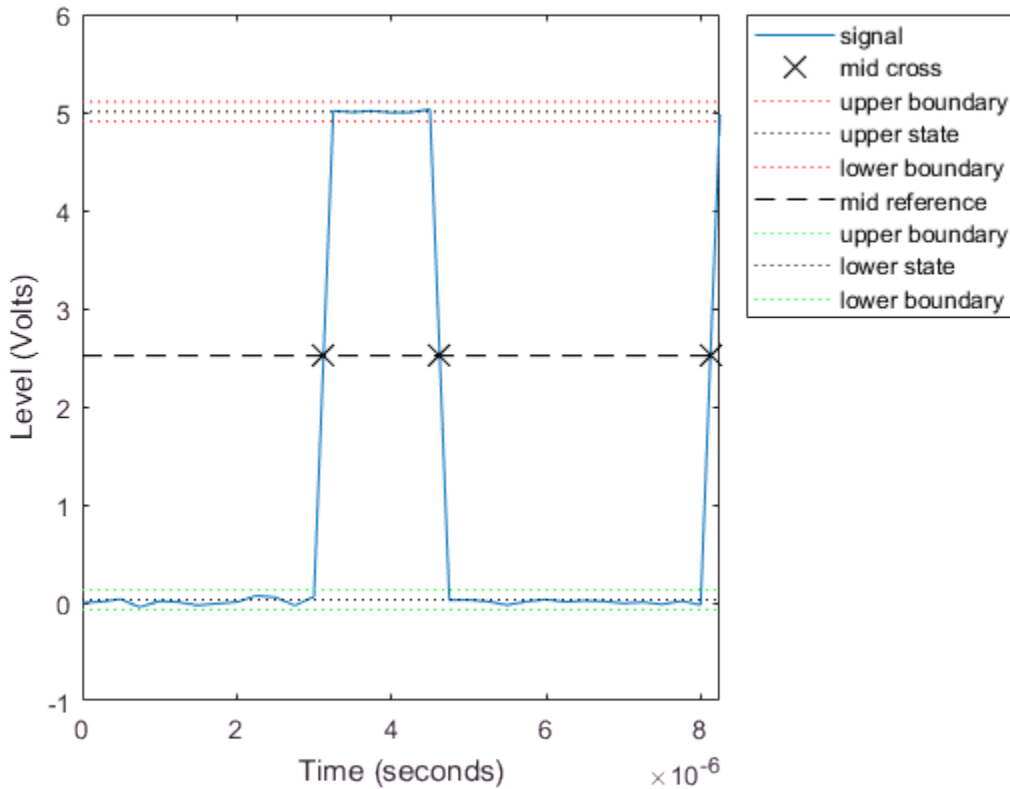

Duty Cycle of Bilevel Waveform with Three Pulses

Create a pulse waveform with three pulses. The sample rate is 4 MHz. Determine the initial and final mid-reference level instants. Plot the result.

```
load('pulseex.mat','x')
fs = 4e6;

pulse = x(1:30);
wavef = [pulse;pulse;pulse];
t = (0:length(wavef)-1)/fs;

[~,initcross,finalcross,~,midlev] = dutycycle(wavef,t)
```



```
initcross =
```

```
1.0e-04 *
```

```
0.0312
```

```
0.1062
```

```
finalcross =
```

```
1.0e-04 *
```

```
0.0463
```

```
0.1213
```

```
midlev = 2.5177
```

Even though there are three pulses, only two pulses have corresponding subsequent transitions. Plot the result.

```
plot(t,wavef)
```

```
hold on
```

```
plot([initcross finalcross],midlev*ones(2),'x','markersize',10)
```

```
hold off
```

```
legend('Waveform','Initial','Final','Location','best')
```

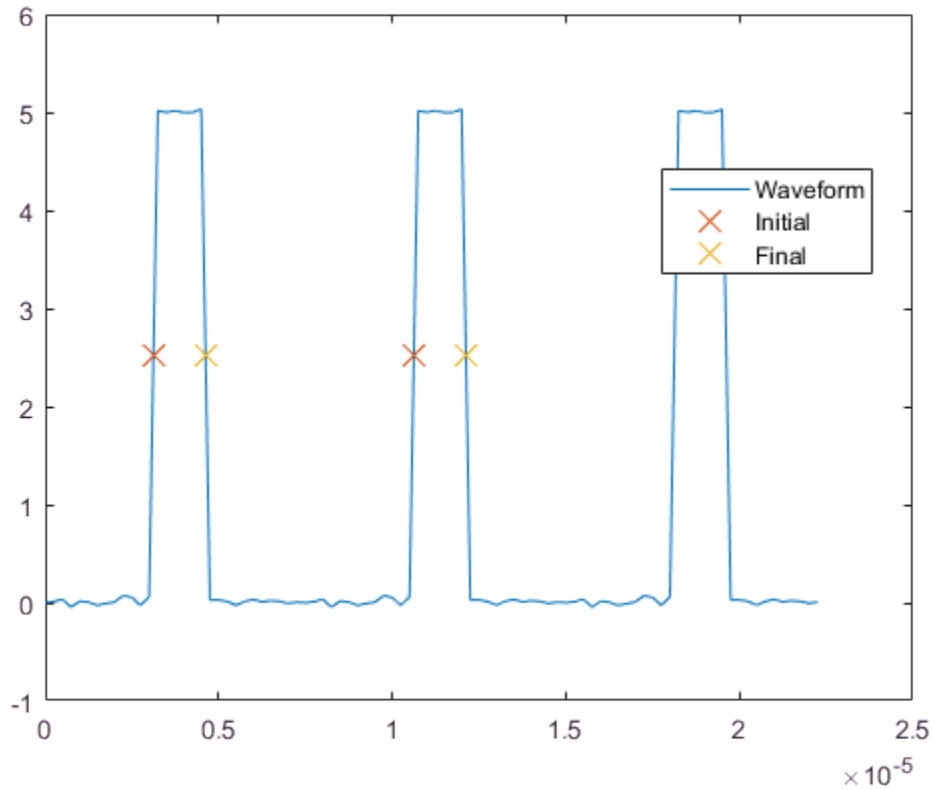

Definitions

Duty Cycle

The energy in a bilevel, or rectangular, pulse is equal to the product of the peak power, P_b , and the pulse width, τ . Devices to measure energy in a waveform operate on time scales longer than the duration of a single pulse. Therefore, it is common to measure the average power

$$P_{\text{av}} = \frac{P_t \tau}{T},$$

where T is the pulse period.

The ratio of average power to peak power is the duty cycle:

$$D = \frac{P_t \tau / T}{P_t}$$

Pulse Polarity

If the pulse has a positive-going initial transition, the pulse has positive polarity. The following figure shows a positive polarity pulse.

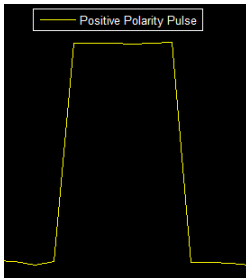

Equivalently, a positive-polarity (positive-going) pulse has a terminating state more positive than the originating state.

If the pulse has a negative-going initial transition, the pulse has negative polarity. The following figure shows a negative-polarity pulse.

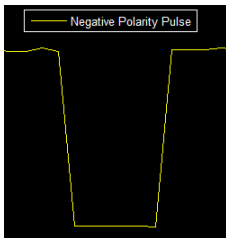

Equivalently, a negative-polarity (negative-going) pulse has a originating state more positive than the terminating state.

State-Level Tolerances

Each state level can have associated lower- and upper-state boundaries. These state boundaries are defined as the state level plus or minus a scalar multiple of the difference between the high state and the low state. To provide a useful tolerance region, the scalar is typically a small number such as 2/100 or 3/100. In general, the $\alpha\%$ region for the low state is defined as

$$S_1 \pm \frac{\alpha}{100}(S_2 - S_1),$$

where S_1 is the low-state level and S_2 is the high-state level. Replace the first term in the equation with S_2 to obtain the $\alpha\%$ tolerance region for the high state.

The following figure illustrates lower and upper 2% state boundaries (tolerance regions) for a positive-polarity bilevel waveform. The red dashed lines indicate the estimated state levels.

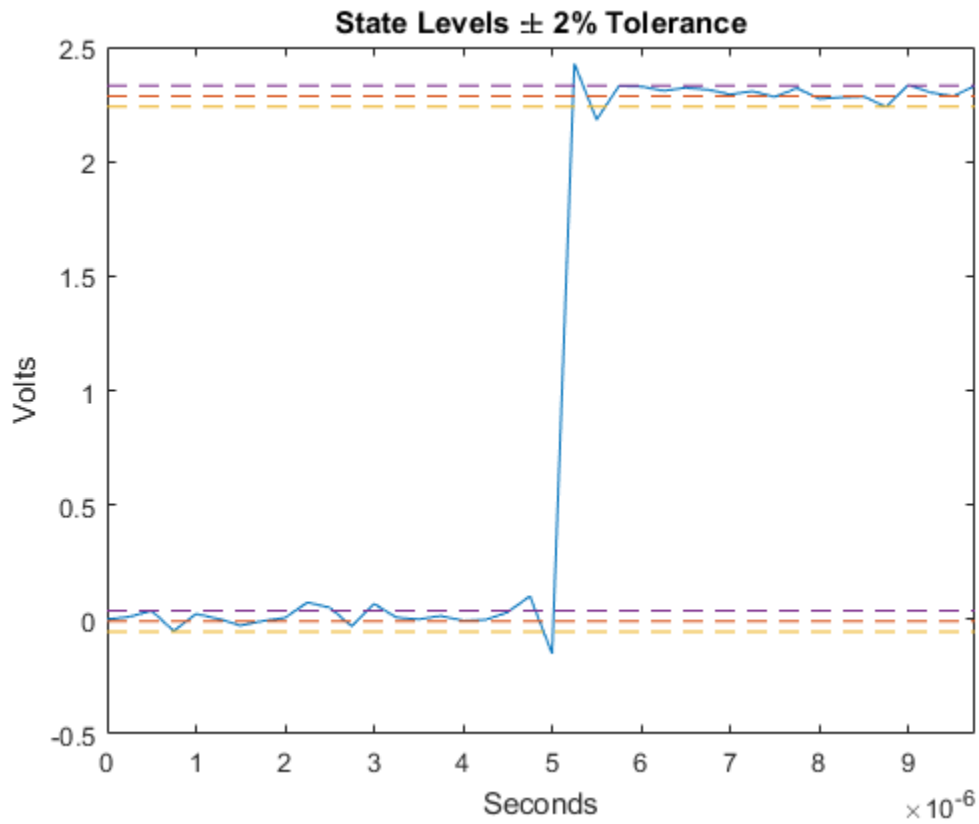

References

- [1] Skolnik, M. I. *Introduction to Radar Systems*. New York, NY: McGraw-Hill, 1980.
- [2] *IEEE Standard on Transitions, Pulses, and Related Waveforms*. IEEE Standard 181, 2003.

See Also

See Also

`midcross` | `pulseperiod` | `pulsesep` | `pulsewidth`

Introduced in R2012a

edr

Edit distance on real signals

Syntax

```
dist = edr(x,y,tol)
[dist,ix,iy] = edr(x,y,tol)

[ ___ ] = edr(x,y,maxsamp)

[ ___ ] = edr( ___,metric)

edr( ___ )
```

Description

`dist = edr(x,y,tol)` returns the “Edit Distance on Real Signals” on page 1-502 between sequences `x` and `y`. `edr` returns the minimum number of elements that must be removed from `x`, `y`, or both `x` and `y`, so that the sum of Euclidean distances between the remaining signal elements lies within the specified tolerance, `tol`.

`[dist,ix,iy] = edr(x,y,tol)` returns the warping path such that `x(ix)` and `y(iy)` have the smallest possible `dist` between them. When `x` and `y` are matrices, `ix` and `iy` are such that `x(:,ix)` and `y(:,iy)` are minimally separated.

`[___] = edr(x,y,maxsamp)` restricts the insertion operations so that the warping path remains within `maxsamp` samples of a straight-line fit between `x` and `y`. This syntax returns any of the output arguments of previous syntaxes.

`[___] = edr(___,metric)` specifies the distance metric to use in addition to any of the input arguments in previous syntaxes. `metric` can be one of 'euclidean', 'absolute', 'squared', or 'symmkl'.

`edr(___)` without output arguments plots the original and aligned signals.

- If the signals are real vectors, then the function displays the two original signals on a subplot and the aligned signals in a subplot below the first one.

- If the signals are complex vectors, then the function displays the original and aligned signals in three-dimensional plots.
- If the signals are real matrices, then the function displays the original and aligned signals as images.
- If the signals are complex matrices, then the real and imaginary portions of the signals appear in the top and bottom half of each image.

Examples

Edit Distance Between Chirp and Sinusoid with Outliers

Generate two real signals: a chirp and a sinusoid. Add a clearly outlying section to each signal.

```
x = cos(2*pi*(3*(1:1000)/1000).^2);  
y = cos(2*pi*9*(1:399)/400);
```

```
x(400:410) = 7;  
y(100:115) = 7;
```

Warp the signals so that the edit distance between them is smallest. Specify a tolerance of 0.1. Plot the aligned signals, both before and after the warping, and output the distance between them.

```
tol = 0.1;  
edr(x,y,tol)
```

```
ans = 617
```

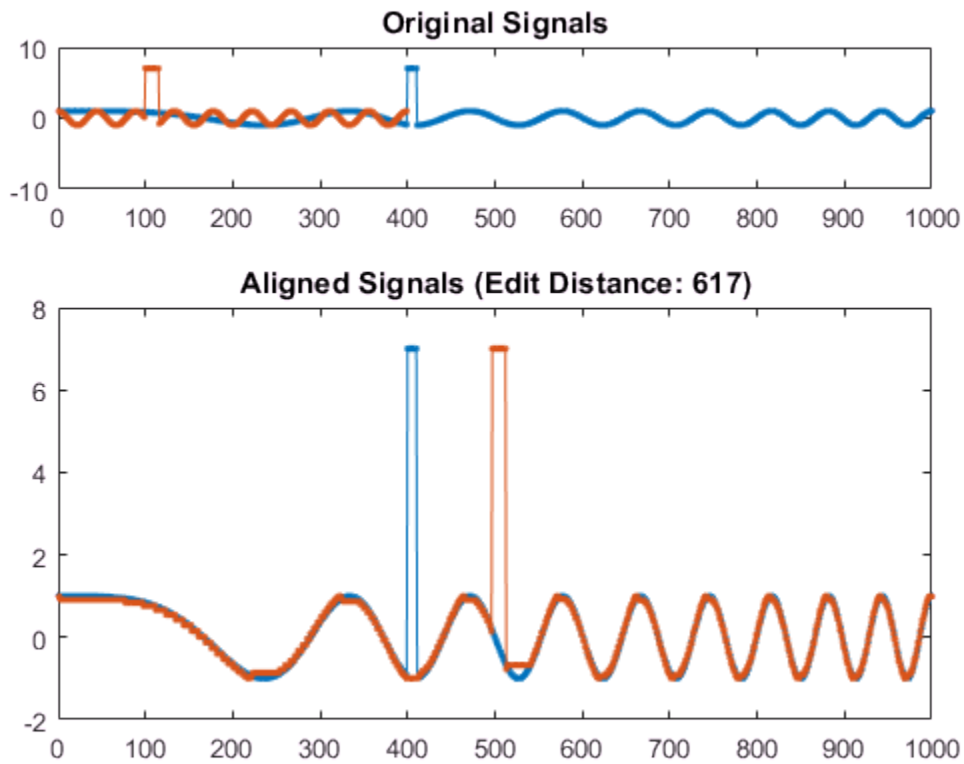
Change the sinusoid frequency to twice its initial value. Repeat the computation.

```
y = cos(2*pi*18*(1:399)/400);  
y(100:115) = 7;  
edr(x,y,tol);
```

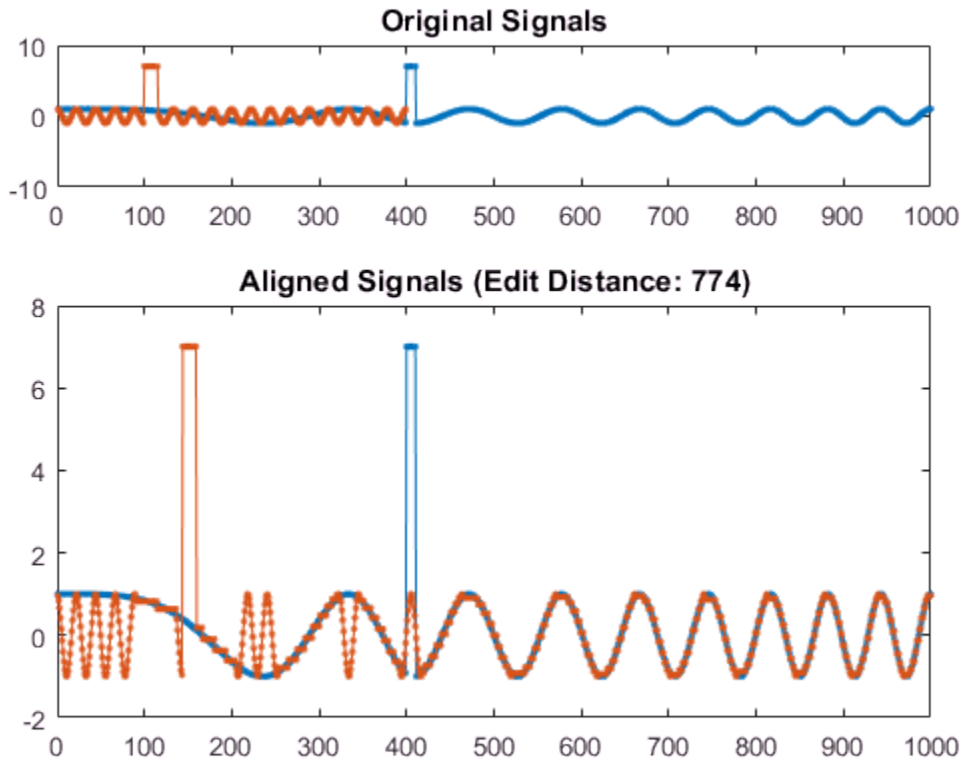

Add an imaginary part to each signal. Restore the initial sinusoid frequency. Align the signals by minimizing the sum of squared Euclidean distances.

```
x = exp(2i*pi*(3*(1:1000)/1000).^2);
y = exp(2i*pi*9*(1:399)/400);

x(400:405) = 5+3j;
x(405:410) = 7;

y(100:107) = 3j;
y(108:115) = 7-3j;

edr(x,y,tol,'squared');
```

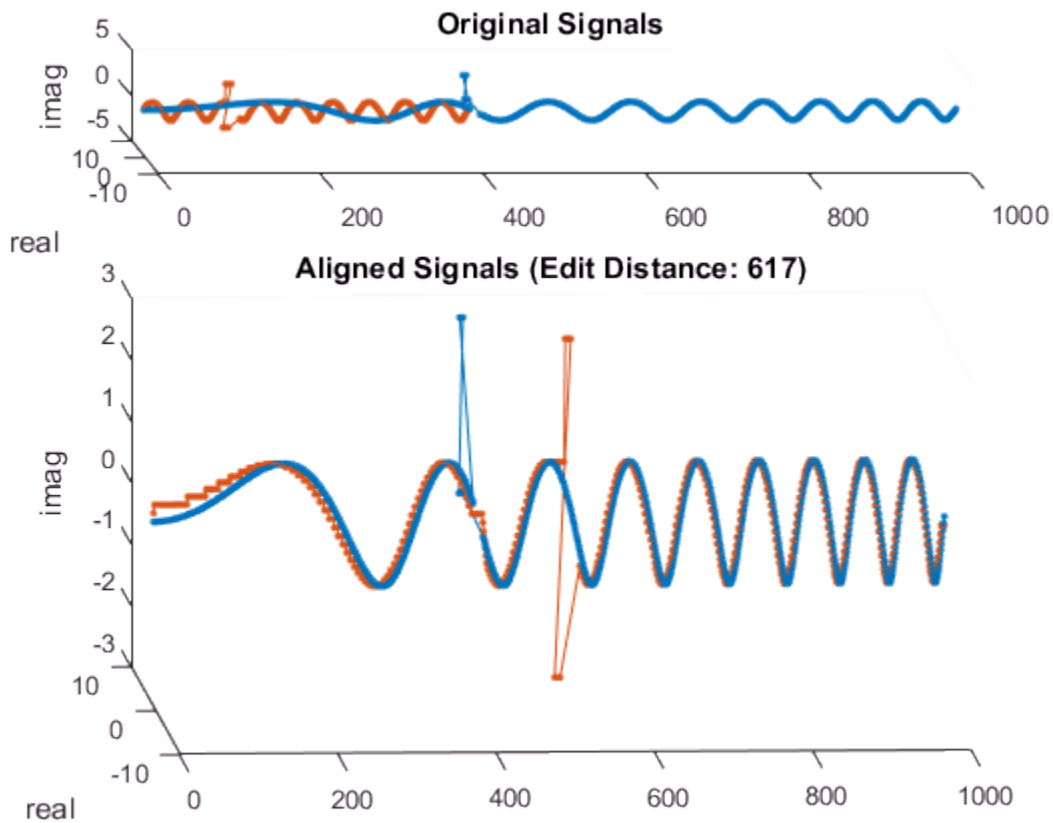

Edit Distance and Warping Path

Generate two signals consisting of two distinct peaks separated by valleys of different lengths. Plot the signals.

```
x1 = [0 1 0 1 0]*.95;
x2 = [0 1 0 0 0 0 0 0 0 0 1 0]*.95;
```

```
subplot(2,1,1)
plot(x1)
xlim([0 12])
subplot(2,1,2)
```

```
plot(x2)  
xlim([0 12])
```

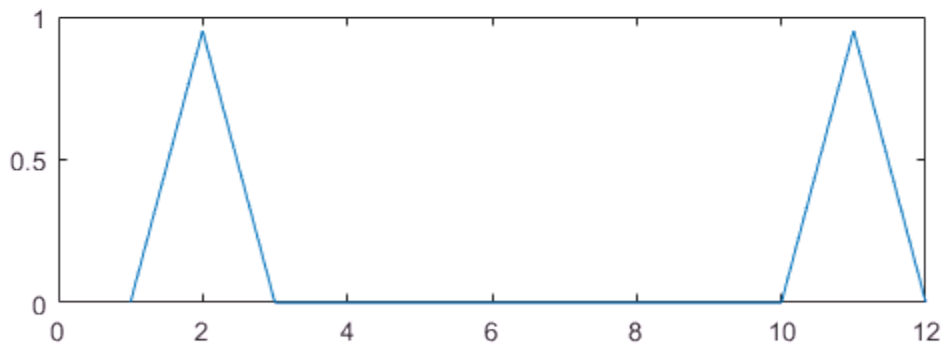
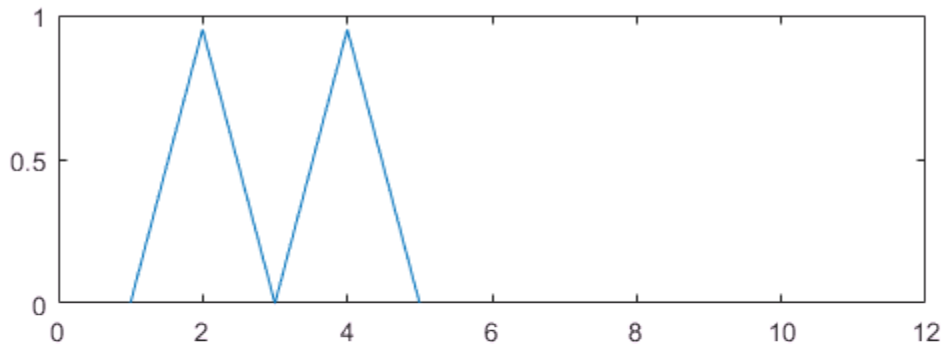

Compute the edit distance between the signals. Set a small tolerance so that the only matches are between equal samples.

```
tol = 0.1;
```

```
figure  
edr(x1,x2,tol);
```

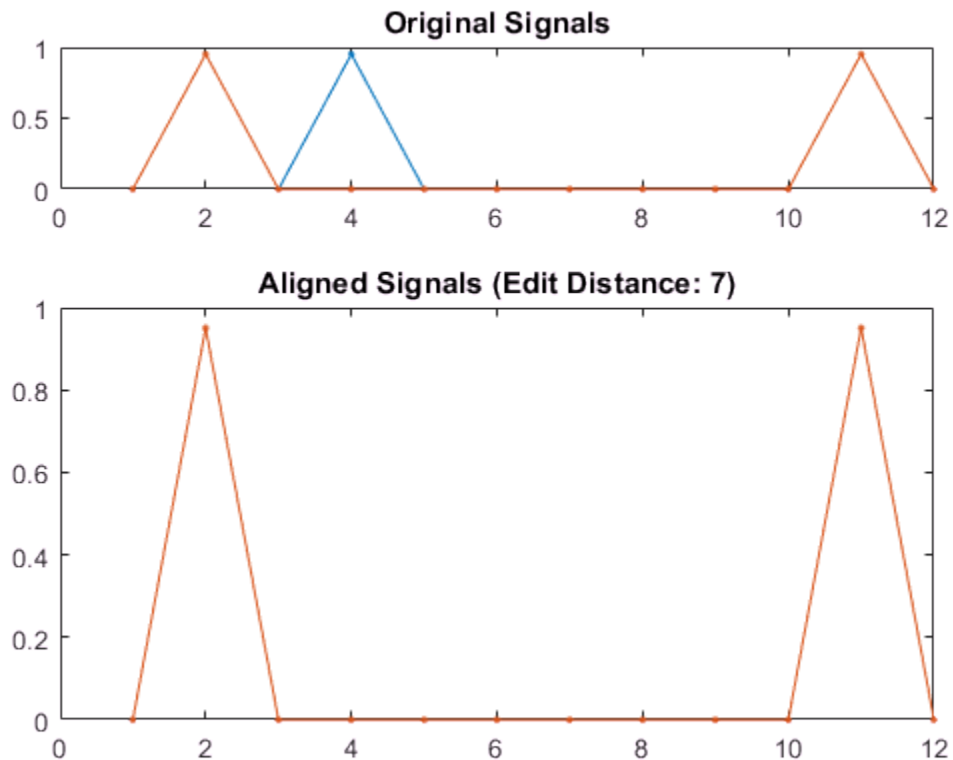

The distance between the signals is 7. To align them, it is necessary to remove the seven central zeros of x_2 or add seven zeros to x_1 .

Compute the \mathbf{D} matrix, whose bottom-right element corresponds to the edit distance. For the definition of \mathbf{D} , see “Edit Distance on Real Signals”.

```

cnd = (abs(x1'-x2))>tol;
D = zeros(length(x1)+1,length(x2)+1);
D(1,2:end) = 1:length(x2);
D(2:end,1) = 1:length(x1);

```

```

for h = 2:length(x1)+1
    for k = 2:length(x2)+1
        D(h,k) = min([D(h-1,k)+1 ...

```

```

        D(h,k-1)+1 ...
        D(h-1,k-1)+cnd(h-1,k-1)];
    end
end

```

D

D =

0	1	2	3	4	5	6	7	8	9	10	11	12
1	0	1	2	3	4	5	6	7	8	9	10	11
2	1	0	1	2	3	4	5	6	7	8	9	10
3	2	1	0	1	2	3	4	5	6	7	8	9
4	3	2	1	1	2	3	4	5	6	7	7	8
5	4	3	2	1	1	2	3	4	5	6	7	7

Compute and display the warping path that aligns the signals.

```
[d,i1,i2] = edr(x1,x2,tol);
```

```
E = zeros(length(x1),length(x2));
```

```

for k = 1:length(i1)
    E(i1(k),i2(k)) = NaN;
end

```

E

E =

NaN	0	0	0	0	0	0	0	0	0	0	0
0	NaN	0	0	0	0	0	0	0	0	0	0
0	0	NaN	NaN	NaN	NaN	NaN	NaN	NaN	NaN	0	0
0	0	0	0	0	0	0	0	0	0	NaN	0
0	0	0	0	0	0	0	0	0	0	0	NaN

Repeat the computation, but now constrain the warping path to deviate at most two elements from the diagonal. Plot the stretched signals and the warping path. In the second plot, set the matrix columns to run along the x -axis.

```
[dc,i1c,i2c] = edr(x1,x2,tol,2);
```

```
subplot(2,1,1)
```

```

plot([x1(i1c);x2(i2c)]','.-')
title(['Distance: ' num2str(dc)])
subplot(2,1,2)
plot(i2c,i1c,'o-',[i2(1) i2(end)],[i1(1) i1(end)])
axis ij
title('Warping Path')

```

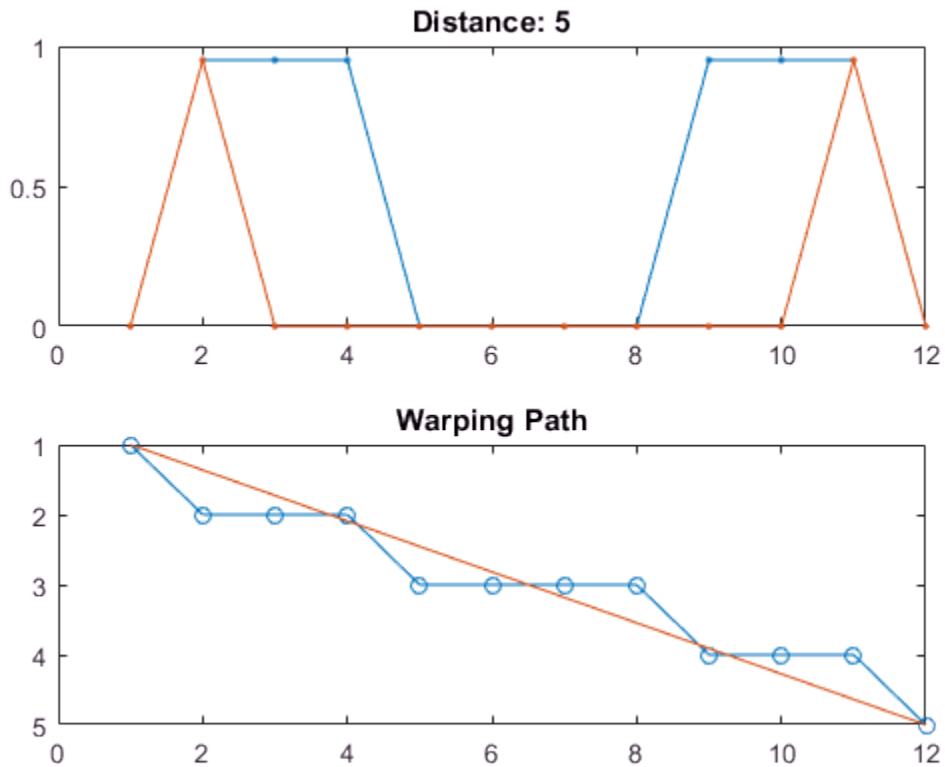

The constraint results in a smaller edit distance but distorts the signals. If the constraint cannot be met, then `edr` returns NaN for the distance. See this by forcing the warping path to deviate at most one element from the diagonal.

```
[dc,i1c,i2c] = edr(x1,x2,tol,1);
```

```

subplot(2,1,1)
plot([x1(i1c);x2(i2c)]','.-')
title(['Distance: ' num2str(dc)])
subplot(2,1,2)
plot(i2c,i1c,'o-',[i2(1) i2(end)],[i1(1) i1(end)])
axis ij
title('Warping Path')

```

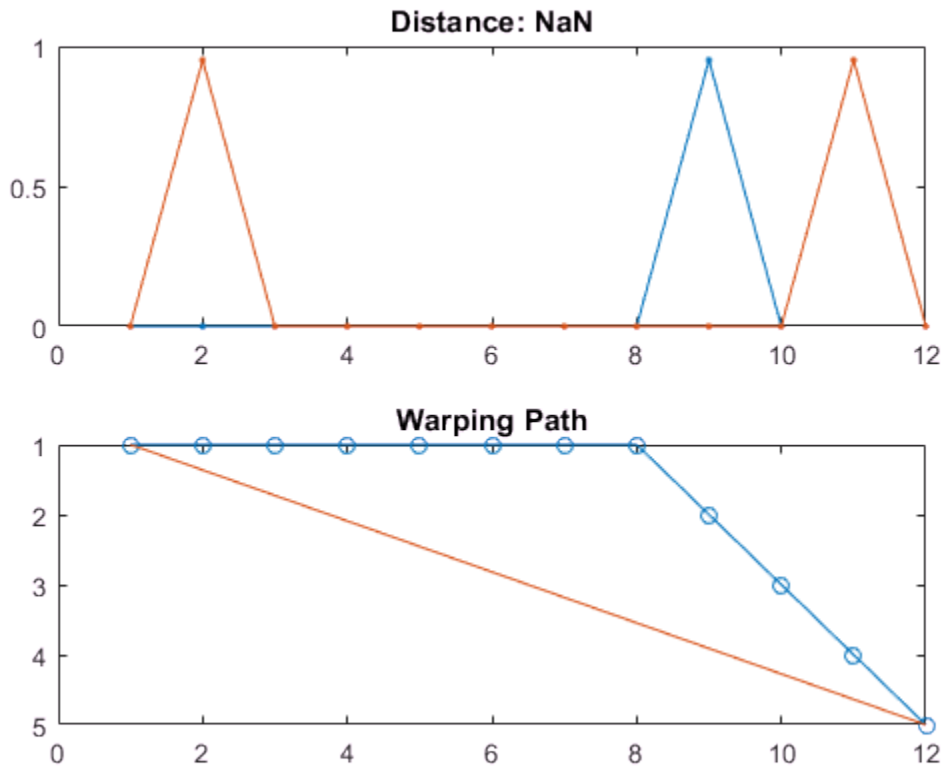

Align Blotched Handwriting Samples

The files `MATLAB1.gif` and `MATLAB2.gif` contain two handwritten samples of the word "MATLAB®." Load the files. Add outliers by blotching the data.



```
samp1 = fullfile(matlabroot, 'examples', 'signal', 'MATLAB1.gif');
samp2 = fullfile(matlabroot, 'examples', 'signal', 'MATLAB2.gif');
```

```
x = double(imread(samp1));
y = double(imread(samp2));
```

```
x(15:20,54:60) = 4000;
y(15:20,84:96) = 4000;
```

Align the handwriting samples along the x -axis using the edit distance. Specify a tolerance of 450.

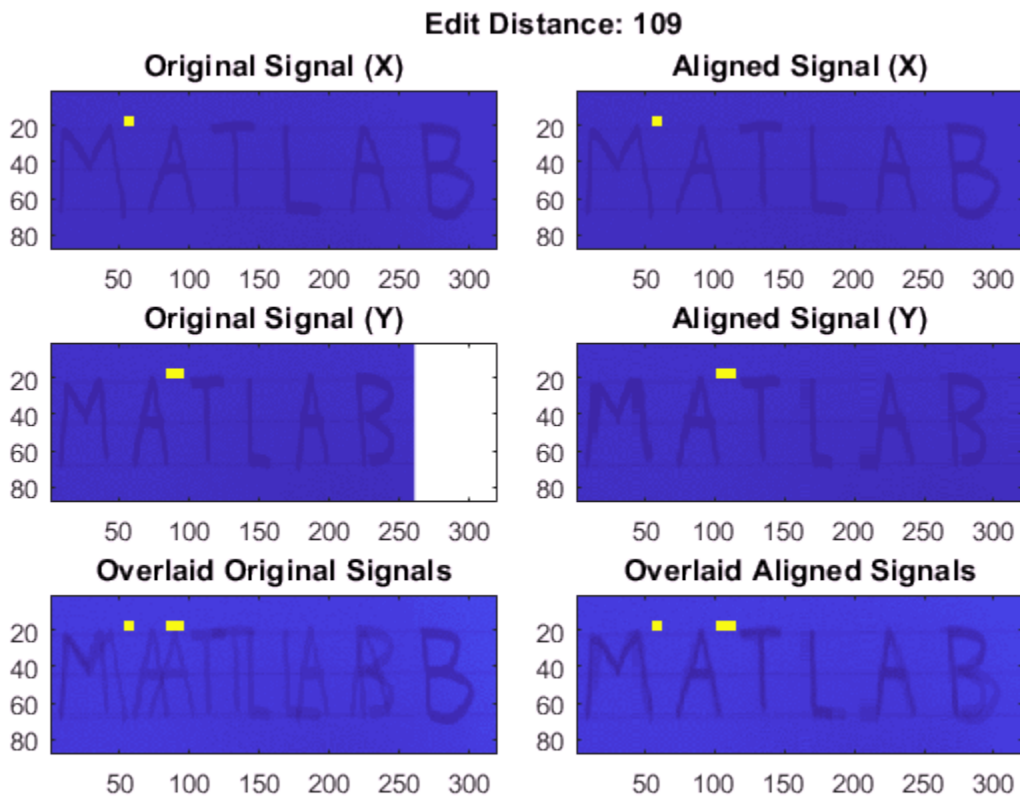
```
edr(x,y,450);
```



Input Arguments

x — Input signal

vector | matrix

Input signal, specified as a real or complex vector or matrix.

Data Types: `single` | `double`

Complex Number Support: Yes

y — Input signal

vector | matrix

Input signal, specified as a real or complex vector or matrix.

Data Types: `single` | `double`

Complex Number Support: Yes

tol — Tolerance

positive scalar

Tolerance, specified as a positive scalar.

Data Types: `single` | `double`

maxsamp — Width of adjustment window

Inf (default) | positive integer

Width of adjustment window, specified as a positive integer.

Data Types: `single` | `double`

metric — Distance metric

'euclidean' (default) | 'absolute' | 'squared' | 'symmkl'

Distance metric, specified as 'euclidean', 'absolute', 'squared', or 'symmkl'. If **X** and **Y** are both K -dimensional signals, then **metric** prescribes $d_{mn}(\mathbf{X}, \mathbf{Y})$, the distance between the m th sample of **X** and the n th sample of **Y**.

- 'euclidean' — Root sum of squared differences, also known as the Euclidean or ℓ_2 metric:

$$d_{mn}(\mathbf{X}, \mathbf{Y}) = \sqrt{\sum_{k=1}^K (x_{k,m} - y_{k,n})^* (x_{k,m} - y_{k,n})}$$

- 'absolute' — Sum of absolute differences, also known as the Manhattan, city block, taxicab, or ℓ_1 metric:

$$d_{mn}(\mathbf{X}, \mathbf{Y}) = \sum_{k=1}^K |x_{k,m} - y_{k,n}| = \sum_{k=1}^K \sqrt{(x_{k,m} - y_{k,n})^* (x_{k,m} - y_{k,n})}$$

- 'squared' — Square of the Euclidean metric, consisting of the sum of squared differences:

$$d_{mn}(\mathbf{X}, \mathbf{Y}) = \sum_{k=1}^K (x_{k,m} - y_{k,n})^* (x_{k,m} - y_{k,n})$$

- 'symmkl' — Symmetric Kullback-Leibler metric. This metric is valid only for real and positive \mathbf{X} and \mathbf{Y} :

$$d_{mn}(\mathbf{X}, \mathbf{Y}) = \sum_{k=1}^K (x_{k,m} - y_{k,n}) (\log x_{k,m} - \log y_{k,n})$$

Data Types: char

Output Arguments

dist — Minimum distance

positive real scalar

Minimum distance between signals, returned as a positive real scalar.

ix, iy — Warping path

vectors of indices

Warping path, returned as vectors of indices. **ix** and **iy** have the same length. Each vector contains a monotonically increasing sequence in which the indices to the elements of the corresponding signal, **x** or **y**, are repeated the necessary number of times.

Definitions

Edit Distance on Real Signals

Two signals with equivalent features arranged in the same order can appear very different due to differences in the durations of their sections. `edr` distorts these durations so that the corresponding features appear at the same location on a common time axis, thus highlighting the similarities between the signals. The criterion used to perform the distortion is designed to be robust to outliers.

Consider the two K -dimensional signals

$$\mathbf{X} = \begin{bmatrix} x_{1,1} & x_{1,2} & \cdots & x_{1,M} \\ x_{2,1} & x_{2,2} & \cdots & x_{2,M} \\ \vdots & \vdots & \ddots & \vdots \\ x_{K,1} & x_{K,2} & \cdots & x_{K,M} \end{bmatrix}$$

and

$$\mathbf{Y} = \begin{bmatrix} y_{1,1} & y_{1,2} & \cdots & y_{1,N} \\ y_{2,1} & y_{2,2} & \cdots & y_{2,N} \\ \vdots & \vdots & \ddots & \vdots \\ y_{K,1} & y_{K,2} & \cdots & y_{K,N} \end{bmatrix},$$

which have M and N samples, respectively. Given $d_{mn}(\mathbf{X}, \mathbf{Y})$, the distance between the m th sample of \mathbf{X} and the n th sample of \mathbf{Y} specified in `metric`, the `edr` function stretches \mathbf{X} and \mathbf{Y} onto a common set of instants such that the *edit distance* between the signals is smallest.

Given ε , a real number that is the tolerance specified in `tol`, declare that the m th sample of \mathbf{X} and the n th sample of \mathbf{Y} *match* if $d_{mn}(\mathbf{X}, \mathbf{Y}) < \varepsilon$. If two samples, m and n , do not match, you can make them match in any of three ways:

- 1 Remove m from the first signal, such as when the next sample does match n . This removal is equivalent to adding m to the second signal and obtaining two consecutive matches.

- 2 Lengthen the first signal by adding in position n a sample that matches n and displacing the rest of the samples by one location. This addition is equivalent to removing the unmatched n from the second signal.
- 3 Substitute m with n in the first signal, or, equivalently, remove both m and n .

The edit distance is the total number of these operations that are needed to make the two signals match. This number is not unique. To compute the smallest possible edit distance between \mathbf{X} and \mathbf{Y} , start from these facts:

- 1 Two empty signals have zero distance between them.
- 2 The distance between an empty signal and a signal with L samples is L , because that is the number of samples that must be added to the empty signal to recover the other one. Equivalently, L is the number of samples that must be removed from an L -sample signal to empty it.

Create an $(M + 1)$ -by- $(N + 1)$ matrix, \mathbf{D} , such that:

- 1 $D_{1,1} = 0$.
- 2 $D_{m,1} = m - 1$ for $m = 2, \dots, M + 1$.
- 3 $D_{1,n} = n - 1$ for $n = 2, \dots, N + 1$.
- 4 For $m, n > 1$,

$$D_{m,n} = \min \left\{ \begin{array}{l} D_{m-1,n} + 1 \\ D_{m,n-1} + 1 \\ D_{m-1,n-1} + \begin{cases} 0 & \Leftarrow d_{m,n}(\mathbf{X}, \mathbf{Y}) \leq \varepsilon \\ 1 & \Leftarrow d_{m,n}(\mathbf{X}, \mathbf{Y}) > \varepsilon \end{cases} \end{array} \right\}.$$

The smallest edit distance between \mathbf{X} and \mathbf{Y} is then $D_{M+1,N+1}$.

The *warping path* through \mathbf{D} that results in this smallest edit distance is parameterized by two sequences of the same length, \mathbf{ix} and \mathbf{iy} , and is a combination of “chess king” moves:

- Vertical moves: $(m,n) \rightarrow (m + 1,n)$ corresponds to removing a sample from \mathbf{X} or adding a sample to \mathbf{Y} . Each move increases the edit distance by 1.
- Horizontal moves: $(m,n) \rightarrow (m,n + 1)$ corresponds to removing a sample from \mathbf{Y} or adding a sample to \mathbf{X} . Each move increases the edit distance by 1.

- Diagonal moves: $(m,n) \rightarrow (m+1,n+1)$ corresponds to a match if $d_{m,n}(\mathbf{X},\mathbf{Y}) \leq \varepsilon$ or corresponds to removing one sample from each signal if $d_{m,n}(\mathbf{X},\mathbf{Y}) > \varepsilon$. Matches do not increase the distance. Removals increase it by 1.

This structure ensures that any acceptable path aligns the complete signals, does not skip samples, and does not repeat signal features. Additionally, a desirable path runs close to the diagonal line extended between $d_{1,1}(\mathbf{X},\mathbf{Y})$ and $d_{M,N}(\mathbf{X},\mathbf{Y})$. This extra constraint, adjusted by the `maxsamp` argument, ensures that the warping compares sections of similar length.

The penalty for making two samples match is independent of the difference in value between the samples. Two samples that differ by a little more than the tolerance incur the same penalty as two samples that are markedly different. For that reason, the edit distance is not affected by outliers. Conversely, repeating samples to align two signals has a cost, which is not the case with dynamic time warping.

References

- [1] Chen, Lei, M. Tamer Özsu, and Vincent Oria. “Robust and Fast Similarity Search for Moving Object Trajectories.” *Proceedings of 24th ACM International Conference on Management of Data (SIGMOD ‘05)*. 2005, pp. 491–502.
- [2] Sakoe, Hiroaki, and Seibi Chiba. “Dynamic Programming Algorithm Optimization for Spoken Word Recognition.” *IEEE Transactions on Acoustics, Speech, and Signal Processing*. Vol.ASSP-26, No.1, 1978, pp.43–49.
- [3] Paliwal, K.K., Anant Agarwal, and Sarvajit S. Sinha. “A Modification over Sakoe and Chiba’s Dynamic Time Warping Algorithm for Isolated Word Recognition.” *Signal Processing*. Vol.4, 1982, pp.329–333.

See Also

See Also

`alignsignals` | `dtw` | `finddelay` | `findsignal` | `xcorr`

Introduced in R2016b

ellip

Elliptic filter design

Syntax

```
[b,a] = ellip(n,Rp,Rs,Wp)
[b,a] = ellip(n,Rp,Rs,Wp,ftype)

[z,p,k] = ellip( ___ )
[A,B,C,D] = ellip( ___ )

[ ___ ] = ellip( ___ , 's' )
```

Description

`[b,a] = ellip(n,Rp,Rs,Wp)` returns the transfer function coefficients of an n th-order lowpass digital elliptic filter with normalized passband edge frequency W_p . The resulting filter has R_p decibels of peak-to-peak passband ripple and R_s decibels of stopband attenuation down from the peak passband value.

`[b,a] = ellip(n,Rp,Rs,Wp,ftype)` designs a lowpass, highpass, bandpass, or bandstop elliptic filter, depending on the value of `ftype` and the number of elements of W_p . The resulting bandpass and bandstop designs are of order $2n$.

Note: See “Limitations” on page 1-515 for information about numerical issues that affect forming the transfer function.

`[z,p,k] = ellip(___)` designs a lowpass, highpass, bandpass, or bandstop digital elliptic filter and returns its zeros, poles, and gain. This syntax can include any of the input arguments in previous syntaxes.

`[A,B,C,D] = ellip(___)` designs a lowpass, highpass, bandpass, or bandstop digital elliptic filter and returns the matrices that specify its state-space representation.

`[___] = ellip(___ , 's')` designs a lowpass, highpass, bandpass, or bandstop analog elliptic filter with passband edge angular frequency W_p , R_p decibels of passband ripple, and R_s decibels of stopband attenuation.

Examples

Lowpass Elliptic Transfer Function

Design a 6th-order lowpass elliptic filter with 5 dB of passband ripple, 40 dB of stopband attenuation, and a passband edge frequency of 300 Hz, which, for data sampled at 1000

Hz, corresponds to 0.6π rad/sample. Plot its magnitude and phase responses. Use it to filter a 1000-sample random signal.

```
[b,a] = ellip(6,5,40,0.6);  
freqz(b,a)
```

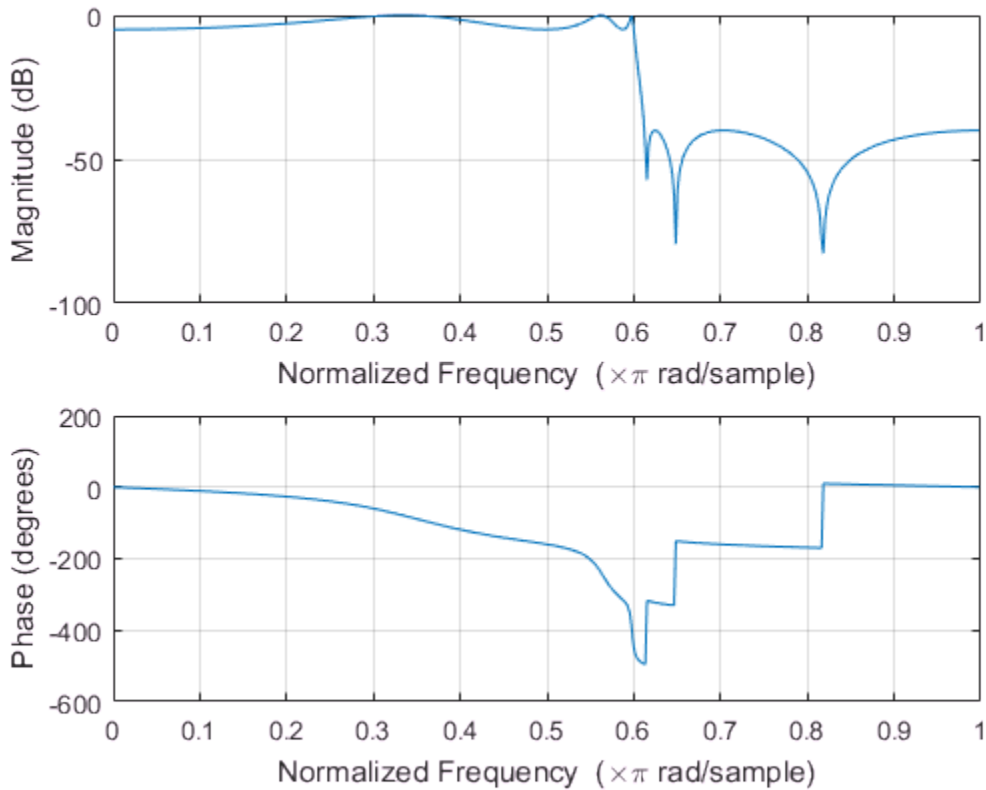

```
dataIn = randn(1000,1);  
dataOut = filter(b,a,dataIn);
```

Bandstop Elliptic Filter

Design a 6th-order elliptic bandstop filter with normalized edge frequencies of 0.2π and 0.6π rad/sample, 5 dB of passband ripple, and 50 dB of stopband attenuation. Plot its magnitude and phase responses. Use it to filter random data.

```
[b,a] = ellip(3,5,50,[0.2 0.6], 'stop');  
freqz(b,a)
```

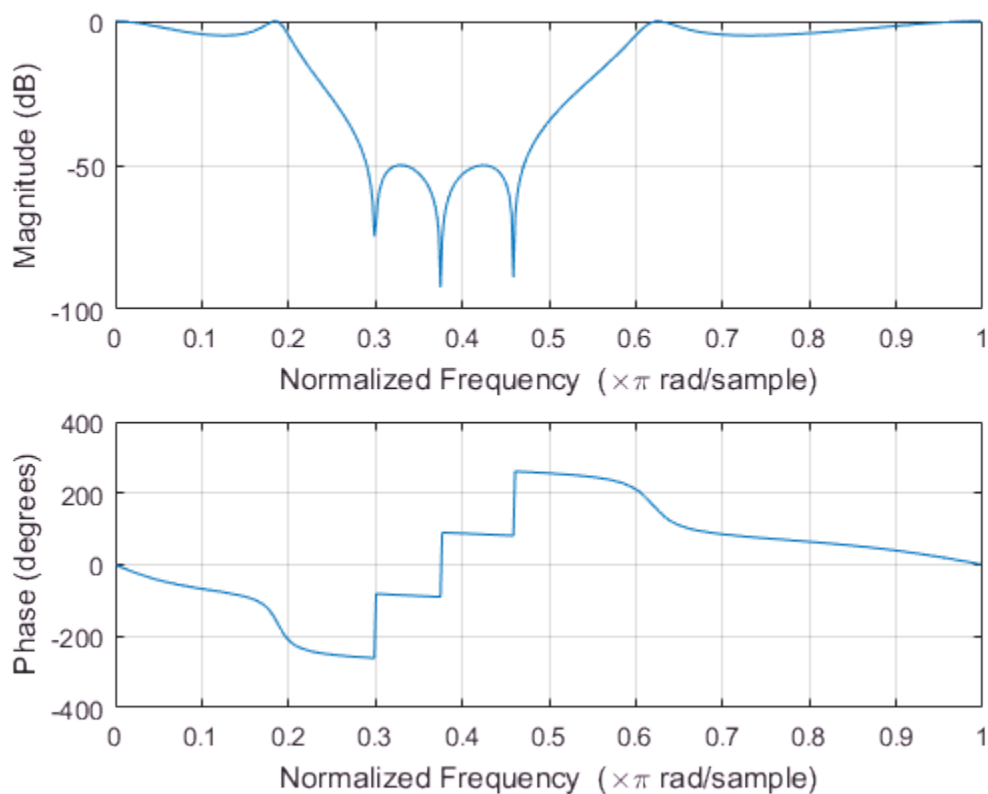

```
dataIn = randn(1000,1);  
dataOut = filter(b,a,dataIn);
```

Highpass Elliptic Filter

Design a 6th-order highpass elliptic filter with a passband edge frequency of 300 Hz, which, for data sampled at 1000 Hz, corresponds to 0.6π rad/sample. Specify 3 dB of passband ripple and 50 dB of stopband attenuation. Plot the magnitude and phase responses. Convert the zeros, poles, and gain to second-order sections for use by `fvtool`.

```
[z,p,k] = ellip(6,3,50,300/500, 'high');
sos = zp2sos(z,p,k);
fvtool(sos, 'Analysis', 'freq')
```

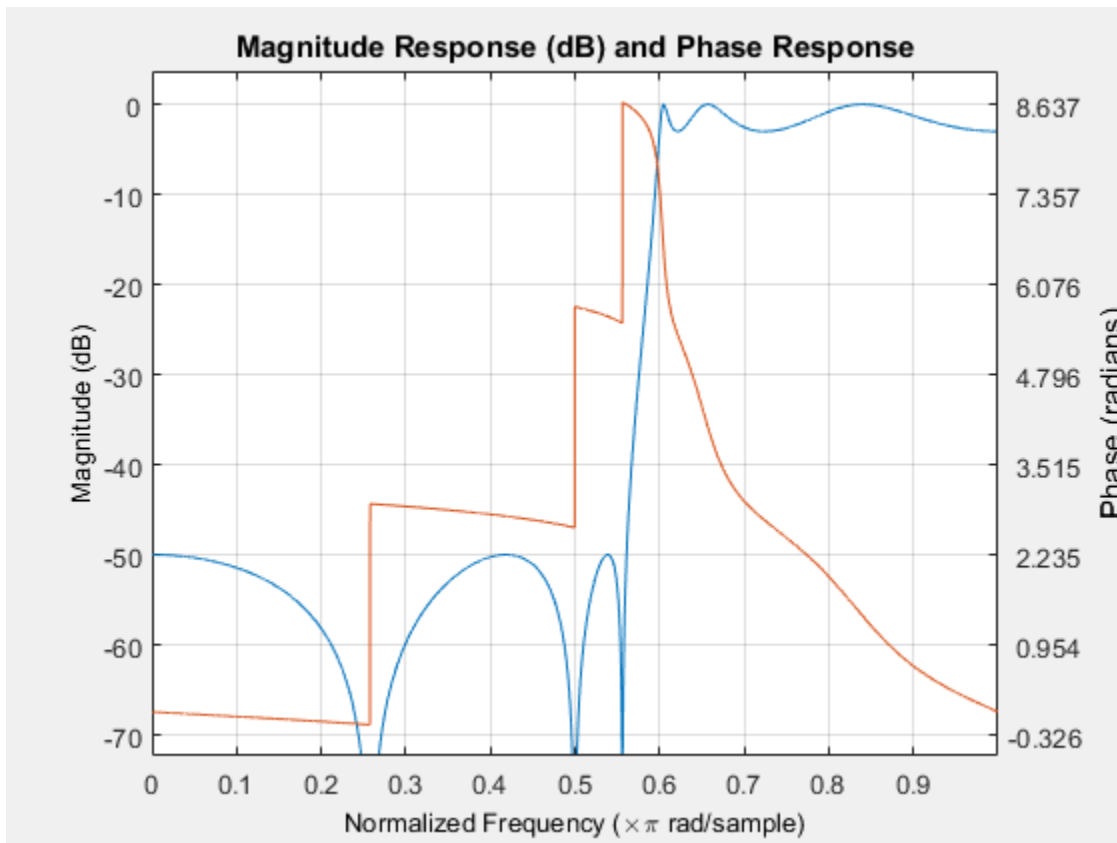

Bandpass Elliptic Filter

Design a 20th-order elliptic bandpass filter with a lower passband frequency of 500 Hz and a higher passband frequency of 560 Hz. Specify a passband ripple of 3 dB, a stopband attenuation of 40 dB, and a sample rate of 1500 Hz. Use the state-space representation. Design an identical filter using `designfilt`.

```
[A,B,C,D] = ellip(10,3,40,[500 560]/750);  
d = designfilt('bandpassiir','FilterOrder',20, ...  
    'PassbandFrequency1',500,'PassbandFrequency2',560, ...  
    'PassbandRipple',3, ...  
    'StopbandAttenuation1',40,'StopbandAttenuation2',40, ...  
    'SampleRate',1500);
```

Convert the state-space representation to second-order sections. Visualize the frequency responses using `fvtool`.

```
sos = ss2sos(A,B,C,D);  
fvt = fvtool(sos,d,'Fs',1500);  
legend(fvt,'ellip','designfilt')
```

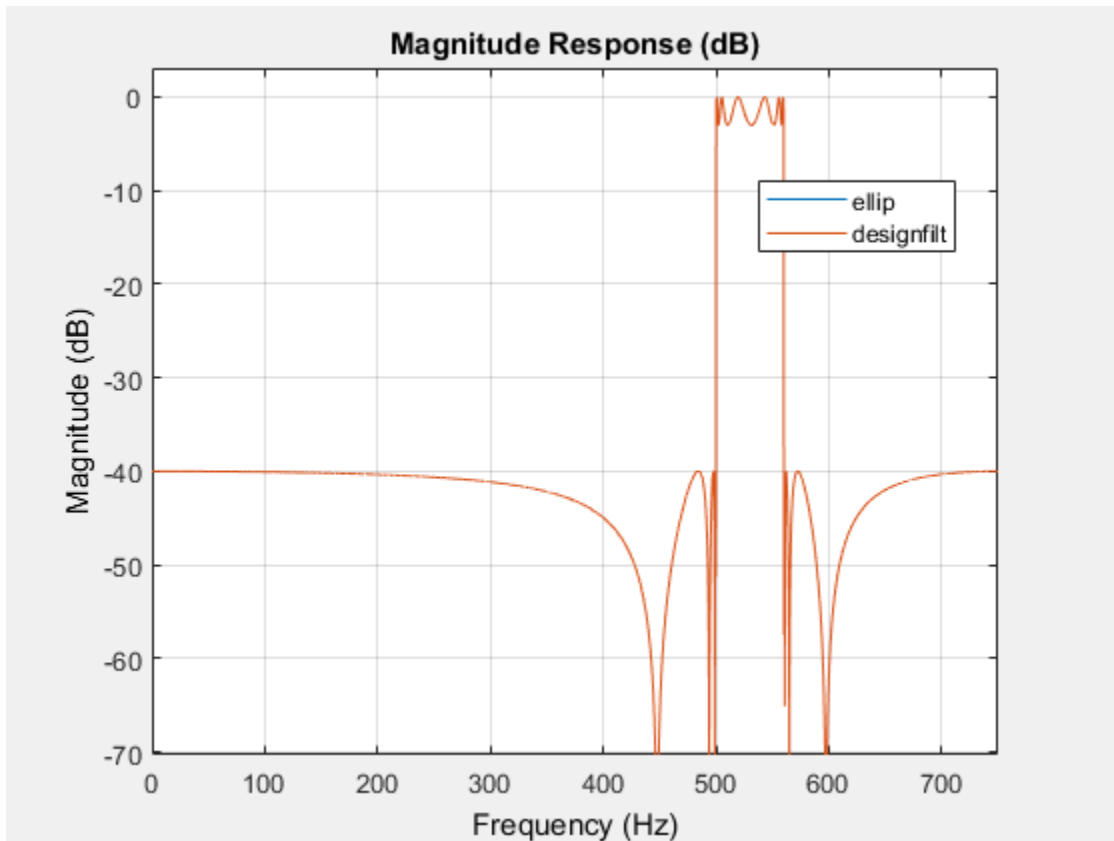

Comparison of Analog IIR Lowpass Filters

Design a 5th-order analog Butterworth lowpass filter with a cutoff frequency of 2 GHz. Multiply by 2π to convert the frequency to radians per second. Compute the frequency response of the filter at 4096 points.

```
n = 5;
f = 2e9;

[zb,pb,kb] = butter(n,2*pi*f,'s');
[bb,ab] = zp2tf(zb,pb,kb);
[hb,wb] = freqs(bb,ab,4096);
```

Design a 5th-order Chebyshev Type I filter with the same edge frequency and 3 dB of passband ripple. Compute its frequency response.

```
[z1,p1,k1] = cheby1(n,3,2*pi*f,'s');
[b1,a1] = zp2tf(z1,p1,k1);
[h1,w1] = freqs(b1,a1,4096);
```

Design a 5th-order Chebyshev Type II filter with the same edge frequency and 30 dB of stopband attenuation. Compute its frequency response.

```
[z2,p2,k2] = cheby2(n,30,2*pi*f,'s');
[b2,a2] = zp2tf(z2,p2,k2);
[h2,w2] = freqs(b2,a2,4096);
```

Design a 5th-order elliptic filter with the same edge frequency, 3 dB of passband ripple, and 30 dB of stopband attenuation. Compute its frequency response.

```
[ze,pe,ke] = ellip(n,3,30,2*pi*f,'s');
[be,ae] = zp2tf(ze,pe,ke);
[he,we] = freqs(be,ae,4096);
```

Plot the attenuation in decibels. Express the frequency in gigahertz. Compare the filters.

```
plot(wb/(2e9*pi),mag2db(abs(hb)))
hold on
plot(w1/(2e9*pi),mag2db(abs(h1)))
plot(w2/(2e9*pi),mag2db(abs(h2)))
plot(we/(2e9*pi),mag2db(abs(he)))
axis([0 4 -40 5])
grid
xlabel('Frequency (GHz)')
ylabel('Attenuation (dB)')
legend('butter','cheby1','cheby2','ellip')
```

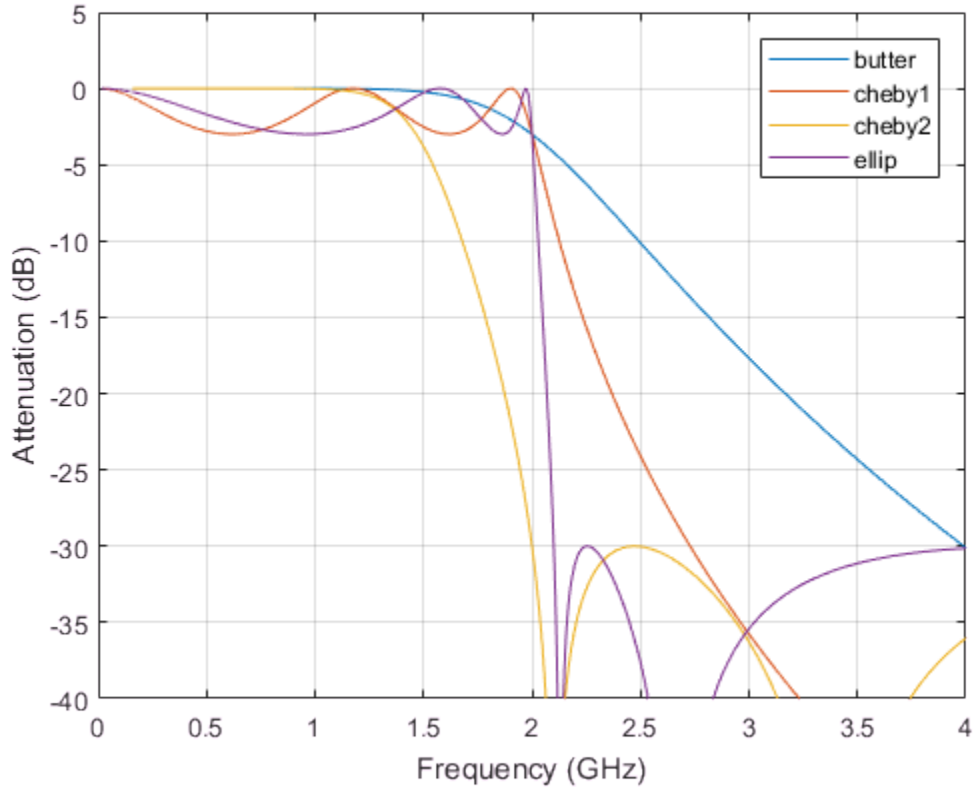

The Butterworth and Chebyshev Type II filters have flat passbands and wide transition bands. The Chebyshev Type I and elliptic filters roll off faster but have passband ripple. The frequency input to the Chebyshev Type II design function sets the beginning of the stopband rather than the end of the passband.

Input Arguments

n — Filter order
integer scalar

Filter order, specified as an integer scalar.

Data Types: double

Rp — Peak-to-peak passband ripple

positive scalar

Peak-to-peak passband ripple, specified as a positive scalar expressed in decibels.

If your specification, ℓ , is in linear units, you can convert it to decibels using

$$R_p = 40 \log_{10}((1+\ell)/(1-\ell)).$$

Data Types: double

Rs — Stopband attenuation

positive scalar

Stopband attenuation down from the peak passband value, specified as a positive scalar expressed in decibels.

If your specification, ℓ , is in linear units, you can convert it to decibels using $R_s = -20 \log_{10}\ell$.

Data Types: double

Wp — Passband edge frequency

scalar | two-element vector

Passband edge frequency, specified as a scalar or a two-element vector. The passband edge frequency is the frequency at which the magnitude response of the filter is $-R_p$ decibels. Smaller values of passband ripple, R_p , and larger values of stopband attenuation, R_s , both result in wider transition bands.

- If W_p is a scalar, then `ellip` designs a lowpass or highpass filter with edge frequency W_p .

If W_p is the two-element vector $[w_1 \ w_2]$, where $w_1 < w_2$, then `ellip` designs a bandpass or bandstop filter with lower edge frequency w_1 and higher edge frequency w_2 .

- For digital filters, the passband edge frequencies must lie between 0 and 1, where 1 corresponds to the Nyquist rate—half the sample rate or π rad/sample.

For analog filters, the passband edge frequencies must be expressed in radians per second and can take on any positive value.

Data Types: double

f_{type} — Filter type

'low' | 'bandpass' | 'high' | 'stop'

Filter type, specified as one of the following:

- 'low' specifies a lowpass filter with passband edge frequency W_p . 'low' is the default for scalar W_p .
- 'high' specifies a highpass filter with passband edge frequency W_p .
- 'bandpass' specifies a bandpass filter of order $2n$ if W_p is a two-element vector. 'bandpass' is the default when W_p has two elements.
- 'stop' specifies a bandstop filter of order $2n$ if W_p is a two-element vector.

Data Types: char

Output Arguments

b, a — Transfer function coefficients

row vectors

Transfer function coefficients of the filter, returned as row vectors of length $n + 1$ for lowpass and highpass filters and $2n + 1$ for bandpass and bandstop filters.

- For digital filters, the transfer function is expressed in terms of **b** and **a** as

$$H(z) = \frac{B(z)}{A(z)} = \frac{b(1) + b(2)z^{-1} + \dots + b(n+1)z^{-n}}{a(1) + a(2)z^{-1} + \dots + a(n+1)z^{-n}}.$$

- For analog filters, the transfer function is expressed in terms of **b** and **a** as

$$H(s) = \frac{B(s)}{A(s)} = \frac{b(1)s^n + b(2)s^{n-1} + \dots + b(n+1)}{a(1)s^n + a(2)s^{n-1} + \dots + a(n+1)}.$$

Data Types: double

z, p, k — Zeros, poles, and gain

column vectors, scalar

Zeros, poles, and gain of the filter, returned as two column vectors of length n ($2n$ for bandpass and bandstop designs) and a scalar.

- For digital filters, the transfer function is expressed in terms of z , p , and k as

$$H(z) = k \frac{(1 - z^{-1}(1))z^{-1}(1 - z^{-1}(2))z^{-1} \cdots (1 - z^{-1}(n))z^{-1}}{(1 - p(1)z^{-1})(1 - p(2)z^{-1}) \cdots (1 - p(n)z^{-1})}$$

- For analog filters, the transfer function is expressed in terms of s , p , and k as

$$H(s) = k \frac{(s - z(1))(s - z(2)) \cdots (s - z(n))}{(s - p(1))(s - p(2)) \cdots (s - p(n))}$$

Data Types: double

A, B, C, D — State-space matrices matrices

State-space representation of the filter, returned as matrices. If $m = n$ for lowpass and highpass designs and $m = 2n$ for bandpass and bandstop filters, then **A** is $m \times m$, **B** is $m \times 1$, **C** is $1 \times m$, and **D** is 1×1 .

- For digital filters, the state-space matrices relate the state vector x , the input u , and the output y through

$$\begin{aligned} x(k+1) &= A x(k) + B u(k) \\ y(k) &= C x(k) + D u(k). \end{aligned}$$

- For analog filters, the state-space matrices relate the state vector x , the input u , and the output y through

$$\begin{aligned} \dot{x} &= A x + B u \\ y &= C x + D u. \end{aligned}$$

Data Types: double

Definitions

Limitations

Numerical Instability of Transfer Function Syntax

In general, use the `[z,p,k]` syntax to design IIR filters. To analyze or implement your filter, you can then use the `[z,p,k]` output with `zp2sos`. If you design the filter using the `[b,a]` syntax, you might encounter numerical problems. These problems are due to round-off errors and can occur for `n` as low as 4. The following example illustrates this limitation.

```
n = 6;
Rp = 0.1;
Rs = 80;
Wn = [2.5e6 29e6]/500e6;
ftype = 'bandpass';

% Transfer Function design
[b,a] = ellip(n,Rp,Rs,Wn,ftype);           % This filter is unstable

% Zero-Pole-Gain design
[z,p,k] = ellip(n,Rp,Rs,Wn,ftype);
sos = zp2sos(z,p,k);

% Plot and compare the results
hfvt = fvtool(b,a,sos,'FrequencyScale','log');
legend(hfvt,'TF Design','ZPK Design')
```

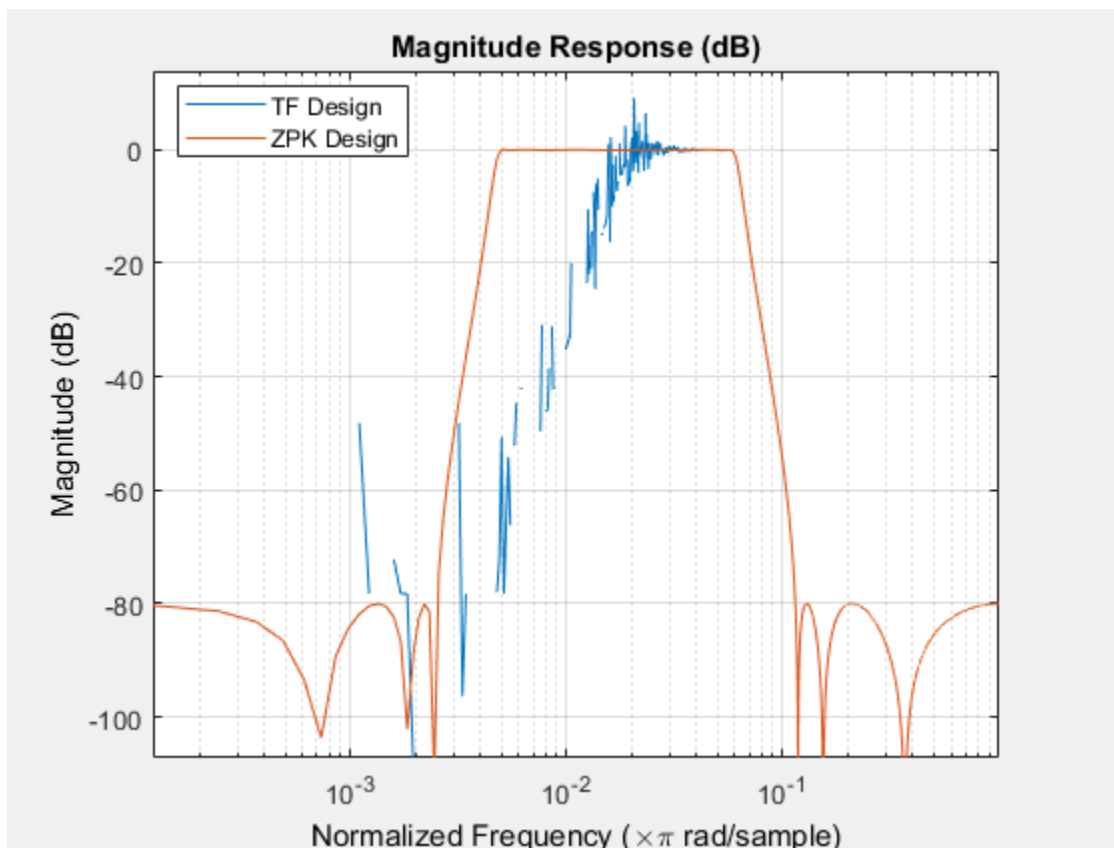

Algorithms

Elliptic filters offer steeper rolloff characteristics than Butterworth or Chebyshev filters, but are equiripple in both the passband and the stopband. In general, elliptic filters meet given performance specifications with the lowest order of any filter type.

`ellip` uses a five-step algorithm:

- 1 It finds the lowpass analog prototype poles, zeros, and gain using the function `ellipap`.
- 2 It converts the poles, zeros, and gain into state-space form.

- 3 If required, it uses a state-space transformation to convert the lowpass filter to a bandpass, highpass, or bandstop filter with the desired frequency constraints.
- 4 For digital filter design, it uses **bilinear** to convert the analog filter into a digital filter through a bilinear transformation with frequency prewarping. Careful frequency adjustment enables the analog filters and the digital filters to have the same frequency response magnitude at ω_p or ω_1 and ω_2 .
- 5 It converts the state-space filter back to transfer function or zero-pole-gain form, as required.

Extended Capabilities

C/C++ Code Generation

Generate C and C++ code using MATLAB® Coder™.

Usage notes and limitations:

All inputs must be constants. Expressions or variables are allowed if their values do not change.

See Also

See Also

`besself` | `butter` | `cheby1` | `cheby2` | `designfilt` | `ellipap` | `ellipord` | `filter` | `sosfilt`

Introduced before R2006a

ellipap

Elliptic analog lowpass filter prototype

Syntax

`[z,p,k] = ellipap(n,Rp,Rs)`

Description

`[z,p,k] = ellipap(n,Rp,Rs)` returns the zeros, poles, and gain of an order n elliptic analog lowpass filter prototype, with R_p dB of ripple in the passband, and a stopband R_s dB down from the peak value in the passband. The zeros and poles are returned in length n column vectors z and p and the gain in scalar k . If n is odd, z is length $n - 1$. The transfer function in factored zero-pole form is

$$H(s) = \frac{z(s)}{p(s)} = k \frac{(s - z_1)(s - z_2)\dots(s - z_N)}{(s - p_1)(s - p_2)\dots(s - p_M)}$$

Elliptic filters offer steeper rolloff characteristics than Butterworth and Chebyshev filters, but they are equiripple in both the passband and the stopband. Of the four classical filter types, elliptic filters usually meet a given set of filter performance specifications with the lowest filter order.

`ellipap` sets the passband edge angular frequency ω_0 of the elliptic filter to 1 for a normalized result. The *passband edge angular frequency* is the frequency at which the passband ends and the filter has a magnitude response of $10^{-R_p/20}$.

Algorithms

`ellipap` uses the algorithm outlined in [1]. It employs `ellipke` to calculate the complete elliptic integral of the first kind and `ellipj` to calculate Jacobi elliptic functions.

References

- [1] Parks, T. W., and C. S. Burrus. *Digital Filter Design*. New York: John Wiley & Sons, 1987, chap. 7.

Extended Capabilities

C/C++ Code Generation

Generate C and C++ code using MATLAB® Coder™.

Usage notes and limitations:

All inputs must be constants. Expressions or variables are allowed if their values do not change.

See Also

`besselap` | `buttap` | `cheb1ap` | `cheb2ap` | `ellip`

Introduced before R2006a

ellipord

Minimum order for elliptic filters

Syntax

```
[n,Wp] = ellipord(Wp,Ws,Rp,Rs)
[n,Wp] = ellipord(Wp,Ws,Rp,Rs, 's')
```

Description

`ellipord` calculates the minimum order of a digital or analog elliptic filter required to meet a set of filter design specifications.

Digital Domain

`[n,Wp] = ellipord(Wp,Ws,Rp,Rs)` returns the lowest order, `n`, of the elliptic filter that loses no more than `Rp` dB in the passband and has at least `Rs` dB of attenuation in the stopband. The scalar (or vector) of corresponding cutoff frequencies `Wp`, is also returned. Use the output arguments `n` and `Wp` in `ellip`.

Choose the input arguments to specify the stopband and passband according to the following table.

Description of Stopband and Passband Filter Parameters

Parameter	Description
<code>Wp</code>	Passband corner frequency <code>Wp</code> , the cutoff frequency, is a scalar or a two-element vector with values between 0 and 1, with 1 corresponding to the normalized Nyquist frequency, π radians per sample.
<code>Ws</code>	Stopband corner frequency <code>Ws</code> , is a scalar or a two-element vector with values between 0 and 1, with 1 corresponding to the normalized Nyquist frequency.
<code>Rp</code>	Passband ripple, in decibels. This value is the maximum permissible passband loss in decibels.
<code>Rs</code>	Stopband attenuation, in decibels. This value is the number of decibels the stopband is attenuated with respect to the passband response.

Use the following guide to specify filters of different types.

Filter Type Stopband and Passband Specifications

Filter Type	Stopband and Passband Conditions	Stopband	Passband
Lowpass	$W_p < W_s$, both scalars	$(W_s, 1)$	$(0, W_p)$
Highpass	$W_p > W_s$, both scalars	$(0, W_s)$	$(W_p, 1)$
Bandpass	The interval specified by W_s contains the one specified by W_p ($W_s(1) < W_p(1) < W_p(2) < W_s(2)$).	$(0, W_s(1))$ and $(W_s(2), 1)$	$(W_p(1), W_p(2))$
Bandstop	The interval specified by W_p contains the one specified by W_s ($W_p(1) < W_s(1) < W_s(2) < W_p(2)$).	$(0, W_p(1))$ and $(W_p(2), 1)$	$(W_s(1), W_s(2))$

If your filter specifications call for a bandpass or bandstop filter with unequal ripple in each of the passbands or stopbands, design separate lowpass and highpass filters according to the specifications in this table, and cascade the two filters together.

Analog Domain

`[n,Wp] = ellipord(Wp,Ws,Rp,Rs, 's')` finds the minimum order n and cutoff frequencies W_p for an analog filter. You specify the frequencies W_p and W_s similar to those described in the Description of Stopband and Passband Filter Parameters table above, only in this case you specify the frequency in radians per second, and the passband or the stopband can be infinite.

Use `ellipord` for lowpass, highpass, bandpass, and bandstop filters as described in the Filter Type Stopband and Passband Specifications table above.

Examples

Lowpass Elliptic Filter Order

For 1000 Hz data, design a lowpass filter with less than 3 dB of ripple in the passband, defined from 0 to 40 Hz, and at least 60 dB of ripple in the stopband, defined from 150 Hz to the Nyquist frequency, 500 Hz. Find the filter order and cutoff frequency.

`Wp = 40/500;`

```
Ws = 150/500;  
Rp = 3;  
Rs = 60;  
[n,Wp] = ellipord(Wp,Ws,Rp,Rs)  
  
n = 4  
  
Wp = 0.0800
```

Specify the filter in terms of second-order sections and plot the frequency response.

```
[z,p,k] = ellip(n,Rp,Rs,Wp);  
sos = zp2sos(z,p,k);  
freqz(sos,512,1000)  
title(sprintf('n = %d Elliptic Lowpass Filter',n))
```

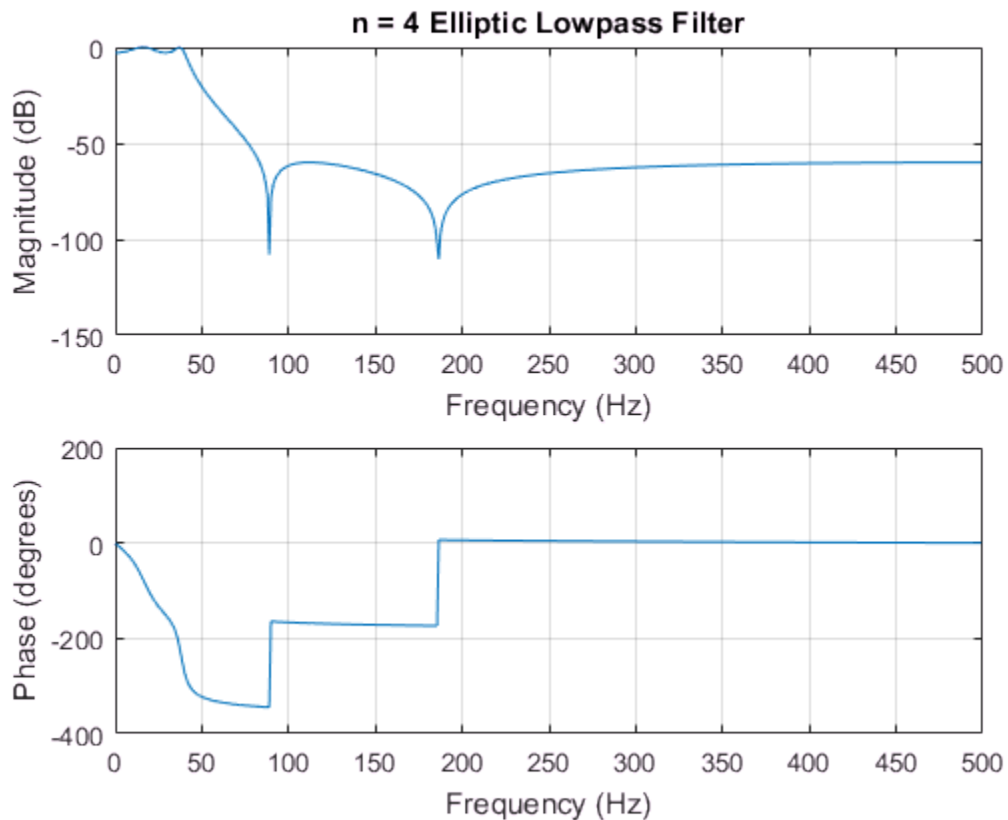

Bandpass Elliptic Filter Order

Design a bandpass filter with a passband from 60 Hz to 200 Hz with at most 3 dB of ripple and at least 40 dB attenuation in the stopbands. Specify a sampling rate of 1 kHz. Have the stopbands be 50 Hz wide on both sides of the passband. Find the filter order and cutoff frequencies.

```
Wp = [60 200]/500;  
Ws = [50 250]/500;  
Rp = 3;  
Rs = 40;  
  
[n,Wp] = ellipord(Wp,Ws,Rp,Rs)  
  
n = 5  
  
Wp =  
  
    0.1200    0.4000
```

Specify the filter in terms of second-order sections and plot the frequency response.

```
[z,p,k] = ellip(n,Rp,Rs,Wp);  
sos = zp2sos(z,p,k);  
  
freqz(sos,512,1000)  
title(sprintf('n = %d Elliptic Bandpass Filter',n))
```

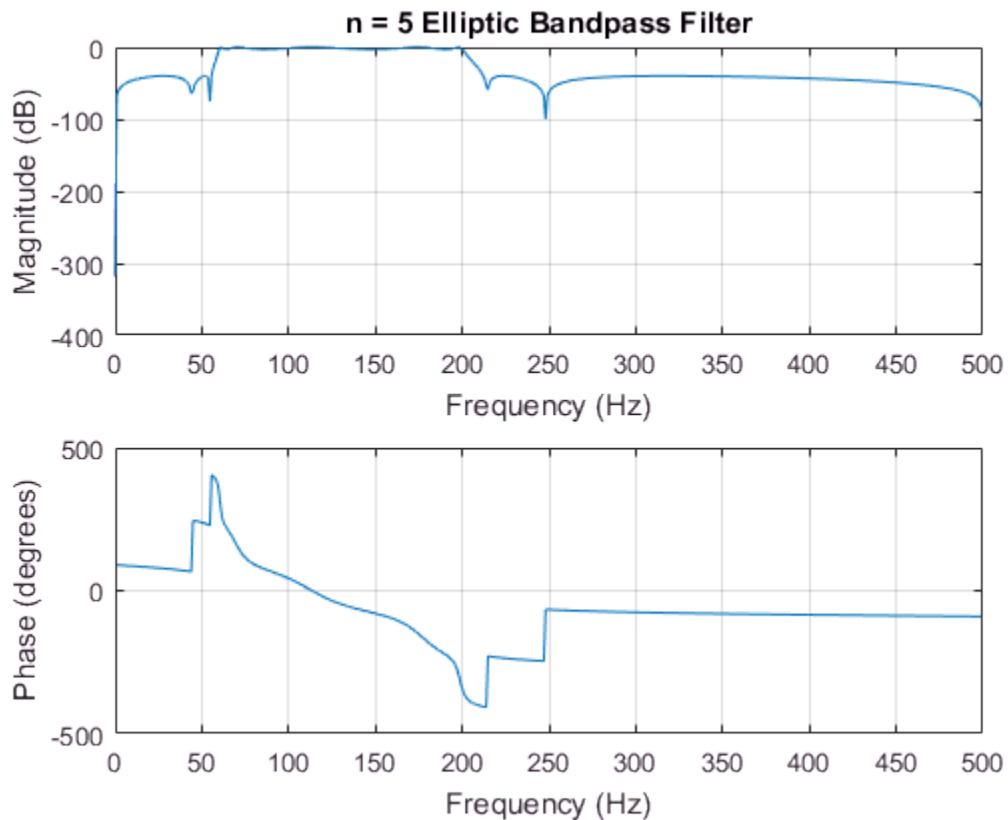

Algorithms

`ellipord` uses the elliptic lowpass filter order prediction formula described in [1]. The function performs its calculations in the analog domain for both the analog and digital cases. For the digital case, it converts the frequency parameters to the s -domain before estimating the order and natural frequencies, and then converts them back to the z -domain.

`ellipord` initially develops a lowpass filter prototype by transforming the passband frequencies of the desired filter to 1 rad/s (for low- and highpass filters) and to -1 and 1

rad/s (for bandpass and bandstop filters). It then computes the minimum order required for a lowpass filter to meet the stopband specification.

References

[1] Rabiner, Lawrence R., and B. Gold. *Theory and Application of Digital Signal Processing*. Englewood Cliffs, NJ: Prentice-Hall, 1975.

Extended Capabilities

C/C++ Code Generation

Generate C and C++ code using MATLAB® Coder™.

Usage notes and limitations:

All inputs must be constants. Expressions or variables are allowed if their values do not change.

See Also

`buttord` | `cheb1ord` | `cheb2ord` | `ellip`

Introduced before R2006a

enbw

Equivalent noise bandwidth

Syntax

```
bw = enbw(window)
bw = enbw(window, fs)
```

Description

`bw = enbw(window)` returns the two-sided equivalent noise bandwidth, `bw`, for a uniformly sampled window, `window`. The equivalent noise bandwidth is normalized by the noise power per frequency bin.

`bw = enbw(window, fs)` returns the two-sided equivalent noise bandwidth, `bw`, in Hz.

Examples

Equivalent Noise Bandwidth of Hamming Window

Determine the equivalent noise bandwidth of a Hamming window 1000 samples in length.

```
bw = enbw(hamming(1000))
```

```
bw = 1.3638
```

Equivalent Noise Bandwidth of Flat Top Window

Determine the equivalent noise bandwidth in Hz of a flat top window 10000 samples in length. The sample rate is 44.1 kHz.

```
bw = enbw(flattopwin(10000), 44.1e3)
```

```
bw = 16.6285
```

Equivalent Rectangular Noise Bandwidth

Obtain the equivalent rectangular noise bandwidth of a Von Hann window and overlay the equivalent rectangular bandwidth on the window's magnitude spectrum. The window is 1000 samples in length and the sampling frequency is 10 kHz.

Set the sampling frequency, create the window, and obtain the discrete Fourier transform of the window with 0 frequency in the center of the spectrum.

```
Fs = 10000;  
win = hann(1000);  
windft = fftshift(fft(win));
```

Obtain the equivalent (rectangular) noise bandwidth of the Von Hann window.

```
bw = enbw(hann(1000),Fs)
```

```
bw = 15.0150
```

Plot the squared-magnitude DFT of the window and use the equivalent noise bandwidth to overlay the equivalent rectangle. The two-sided bandwidth is split evenly across the spectrum.

```
freq = -(Fs/2):Fs/length(win):Fs/2-(Fs/length(win));  
maxgain = 20*log10(abs(windft(length(win)/2+1)));  
  
plot(freq,20*log10(abs(windft)))  
hold on  
plot(bw/2*[-1 -1 1 1],[-40 maxgain maxgain -40], '--')  
hold off  
  
xlabel('Hz')  
ylabel('dB')  
axis([-60 60 -40 60])
```

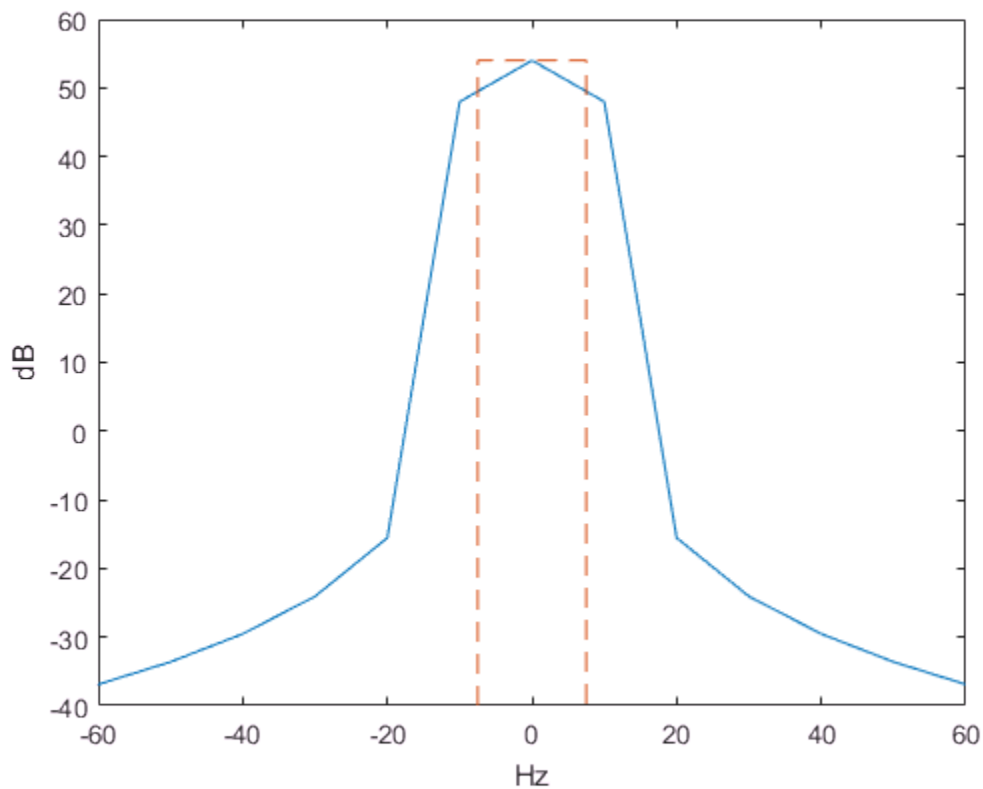

Input Arguments

window — Window vector

real-valued row or column vector

Uniformly sampled window vector, specified as a row or column vector with real-valued elements.

Example: `hamming(1000)`

Data Types: `double` | `single`

fs — Sampling frequency

positive scalar

Sampling frequency, specified as a positive scalar.

Output Arguments

bw — Equivalent noise bandwidth

positive scalar

Equivalent noise bandwidth, specified as a positive scalar.

Data Types: `double` | `single`

Definitions

Equivalent Noise Bandwidth

The equivalent noise bandwidth of a window is the width of a rectangle whose area contains the same total power as the window. The height of the rectangle is the peak squared magnitude of the window's Fourier transform.

Assuming a sampling interval of 1, the total energy for the window, $w(n)$, can be expressed in the frequency or time-domain as

$$\int_{-1/2}^{1/2} |W(f)|^2 df = \sum_n |w(n)|^2.$$

The peak magnitude of the window's spectrum occurs at $f = 0$. This is given by

$$|W(0)|^2 = \left| \sum_n w(n) \right|^2.$$

To find the width of the equivalent rectangular bandwidth, divide the area by the height.

$$\frac{\int_{-1/2}^{1/2} |W(f)|^2 df}{|W(0)|^2} = \frac{\sum_n |w(n)|^2}{\left| \sum_n w(n) \right|^2}.$$

See “Equivalent Rectangular Noise Bandwidth” on page 1-528 for an example that plots the equivalent rectangular bandwidth over the magnitude spectrum of a von Hann window.

See Also

See Also

bandpower | sfdr

Introduced in R2013a

envelope

Signal envelope

Syntax

```
[yupper,ylower] = envelope(x)
```

```
[yupper,ylower] = envelope(x,f1,'analytic')
```

```
[yupper,ylower] = envelope(x,w1,'rms')
```

```
[yupper,ylower] = envelope(x,np,'peak')
```

```
envelope( ___ )
```

Description

`[yupper,ylower] = envelope(x)` returns the upper and lower envelopes of the input sequence, `x`, as the magnitude of its analytic signal. The analytic signal of `x` is found using the discrete Fourier transform as implemented in `hilbert`. The function initially removes the mean of `x` and adds it back after computing the envelopes. If `x` is a matrix, then `envelope` operates independently over each column of `x`.

`[yupper,ylower] = envelope(x,f1,'analytic')` returns the envelopes of `x` determined using the magnitude of its analytic signal. The analytic signal is computed by filtering `x` with a Hilbert FIR filter of length `f1`. This syntax is used if you specify only two arguments.

`[yupper,ylower] = envelope(x,w1,'rms')` returns the upper and lower root-mean-square envelopes of `x`. The envelopes are determined using a sliding window of length `w1` samples.

`[yupper,ylower] = envelope(x,np,'peak')` returns the upper and lower peak envelopes of `x`. The envelopes are determined using spline interpolation over local maxima separated by at least `np` samples.

`envelope(___)` with no output arguments plots the signal and its upper and lower envelopes. This syntax accepts any of the input arguments from previous syntaxes.

Examples

Analytic Envelopes of Chirp

Generate a quadratic chirp modulated by a Gaussian. Specify a sample rate of 2 kHz and a signal duration of 2 seconds.

```
t = 0:1/2000:2-1/2000;  
q = chirp(t-2,4,1/2,6,'quadratic',100,'convex').*exp(-4*(t-1).^2);  
plot(t,q)
```

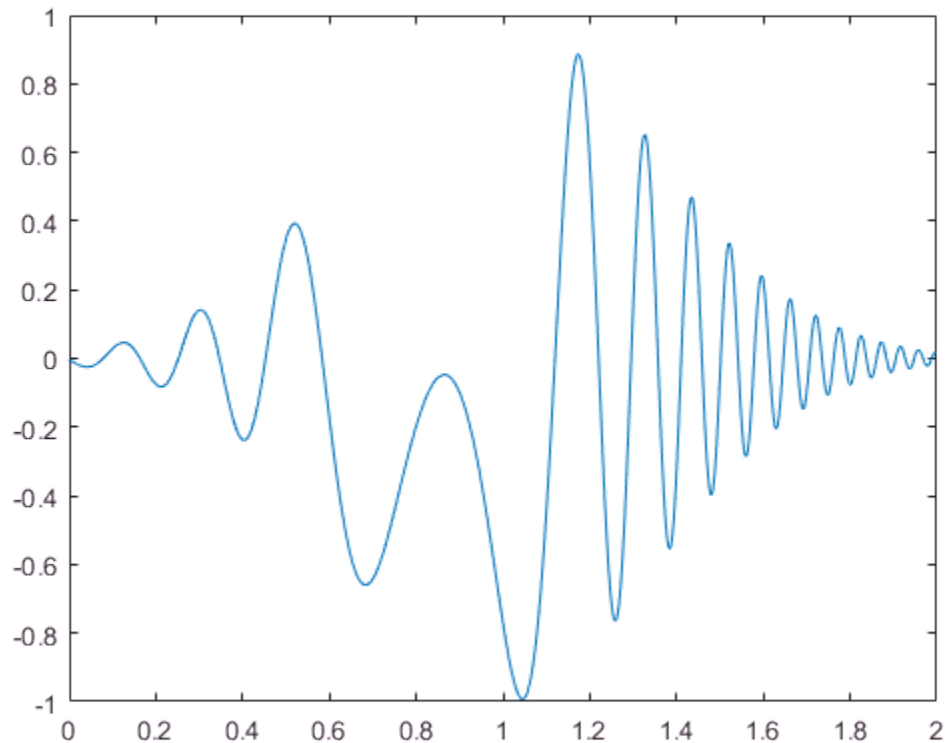

Compute the upper and lower envelopes of the chirp using the analytic signal.

```
[up,lo] = envelope(q);  
hold on  
plot(t,up,t,lo,'linewidth',1.5)  
legend('q','up','lo')  
hold off
```

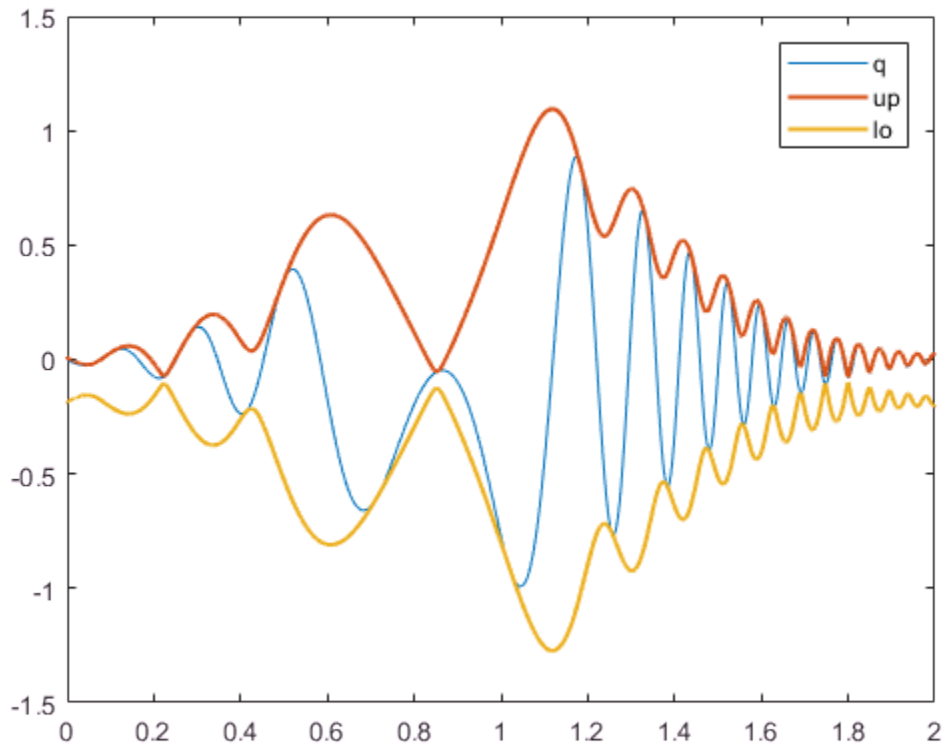

The signal is asymmetric due to the nonzero mean.

Use `envelope` without output arguments to plot the signal and envelopes as a function of sample number.

```
envelope(q)
```

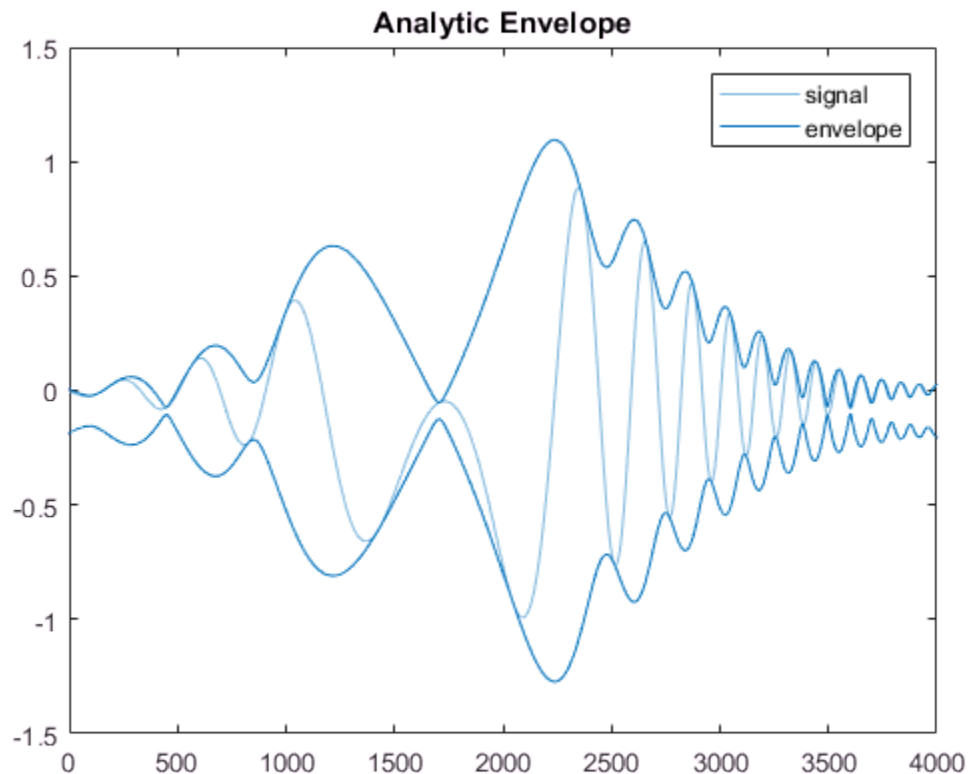

Analytic Envelopes of Multichannel Signal Using Filter

Create a two-channel signal sampled at 1 kHz for 3 seconds:

- One channel is an exponentially decaying sinusoid. Specify a frequency of 7 Hz and a time constant of 2 seconds.
- The other channel is a time-displaced Gaussian-modulated chirp with a DC value of 2. Specify an initial chirp frequency of 30 Hz that decays to 5 Hz after 2 seconds.

Plot the signal.

```
t = 0:1/1000:3;
```

```
q1 = sin(2*pi*7*t).*exp(-t/2);  
q2 = chirp(t,30,2,5).*exp(-(2*t-3).^2)+2;  
q = [q1;q2]';  
  
plot(t,q)
```

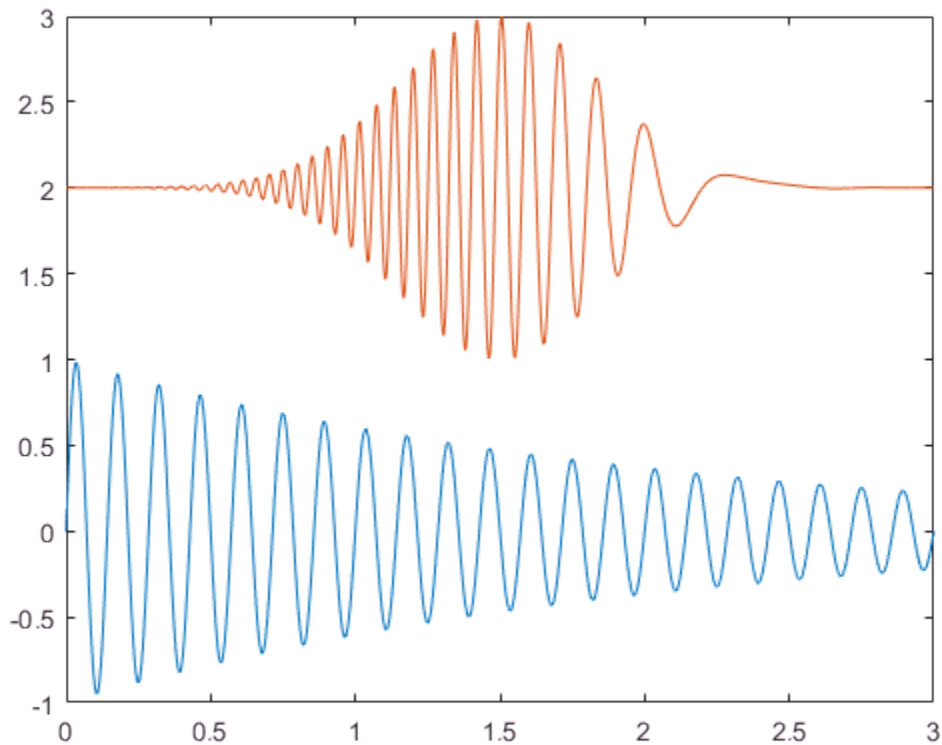

Compute the upper and lower envelopes of the signal. Use a Hilbert filter with a length of 100. Plot the channels and the envelopes. Use solid lines for the upper envelopes and dashed lines for the lower envelopes.

```
[up,lo] = envelope(q,100,'analytic');  
hold on  
plot(t,up,'-',t,lo,'--')  
hold off
```

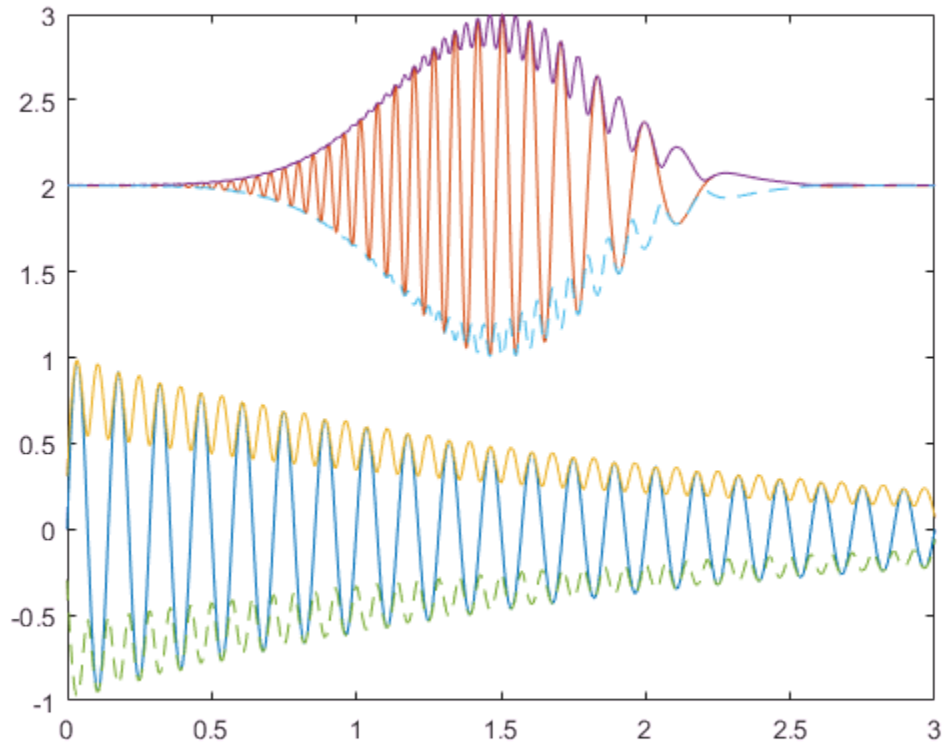

Call `envelope` without output arguments to produce a plot of the signal and its envelopes as a function of sample number. Increase the filter length to 300 to obtain a smoother shape. The `'analytic'` flag is the default when you specify two input arguments.

```
envelope(q,300)
```

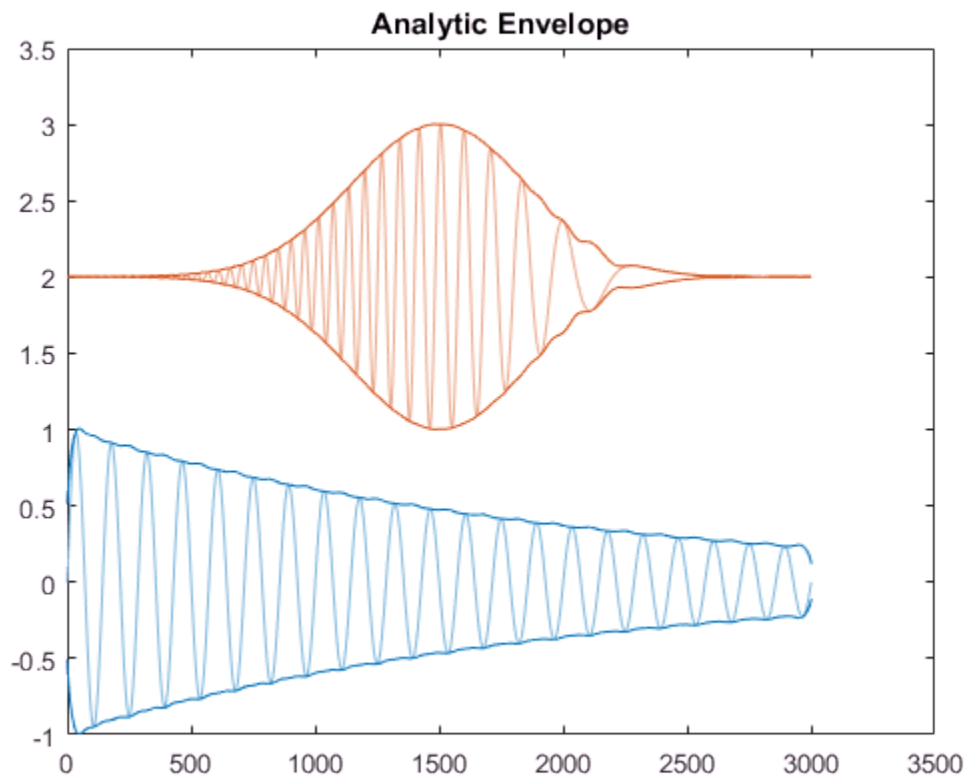

Moving RMS Envelopes of Audio Recording

Compute and plot the moving RMS envelopes of a recording of a train whistle. Use a window with a length of 150 samples.

```
load('train')  
envelope(y,150,'rms')
```

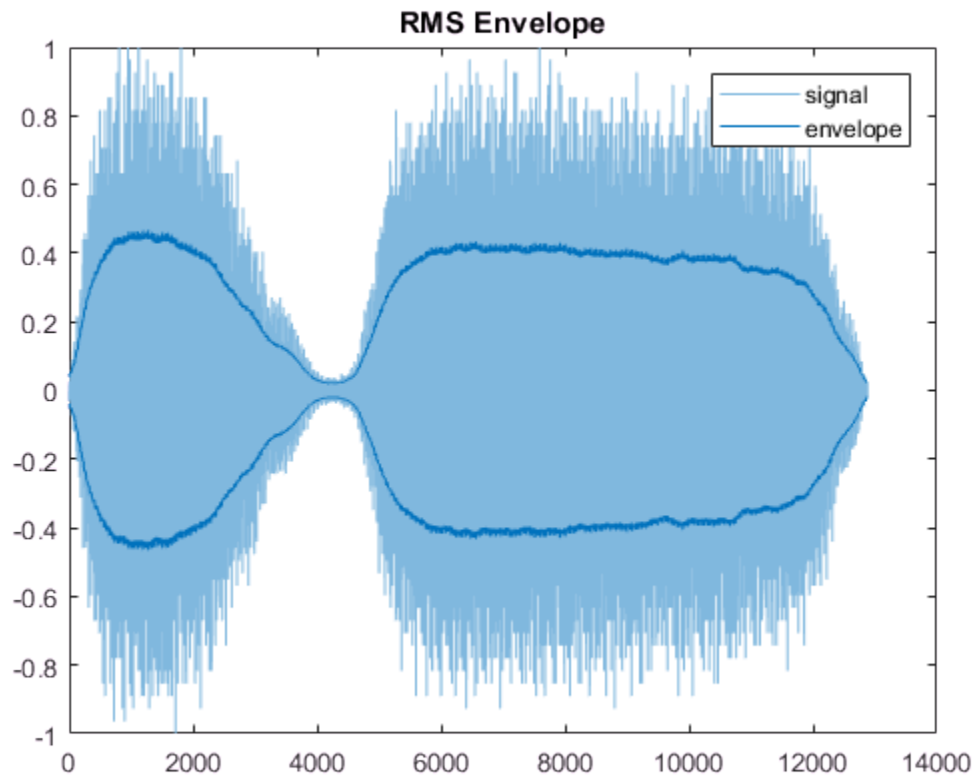



Peak Envelopes of Speech Signal

Plot the upper and lower peak envelopes of a speech signal smoothed over 30-sample intervals.

```
load('mtlb')
```

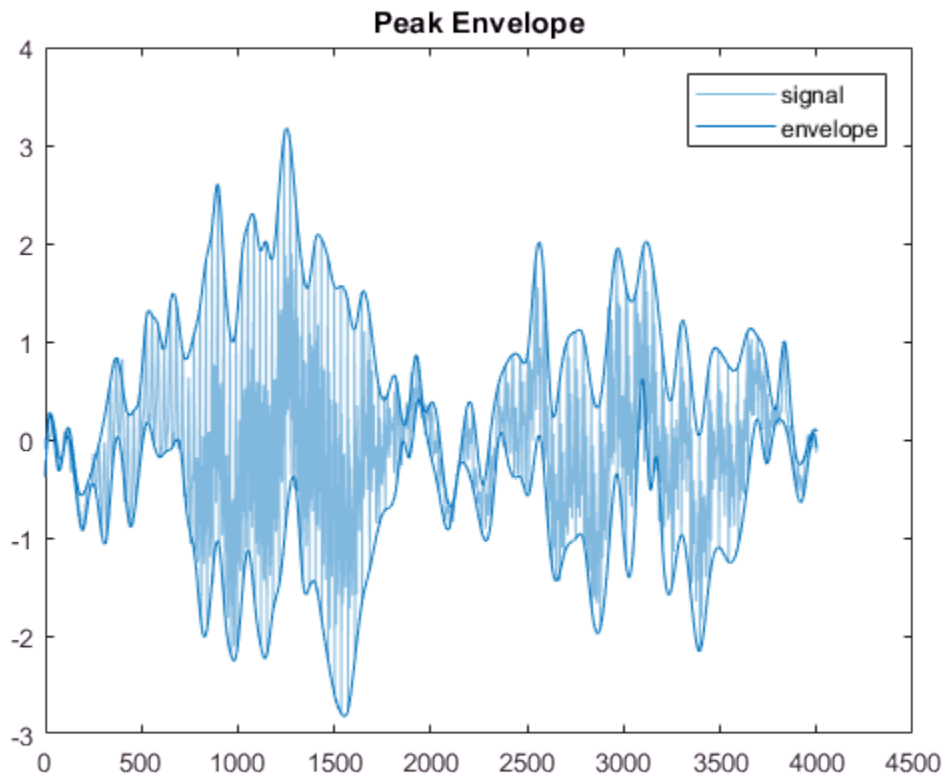
```
envelope(mtlb,30,'peak')
```



Envelope of Asymmetric Sequence

Create and plot a signal that resembles the initial detection of a light pulse propagating through a dispersive medium.

```
t = 0.5:-1/100:-2.49;  
z = airy(t*10).*exp(-t.^2);  
  
plot(z)
```

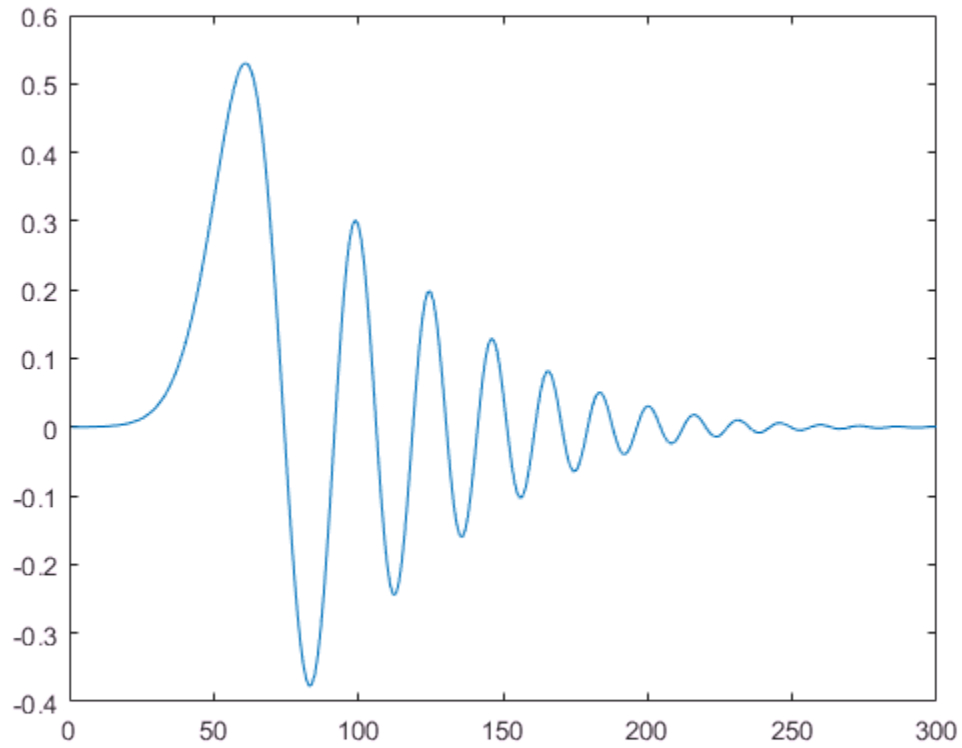

Determine the envelopes of the sequence using the magnitude of its analytic signal. Plot the envelopes.

`envelope(z)`

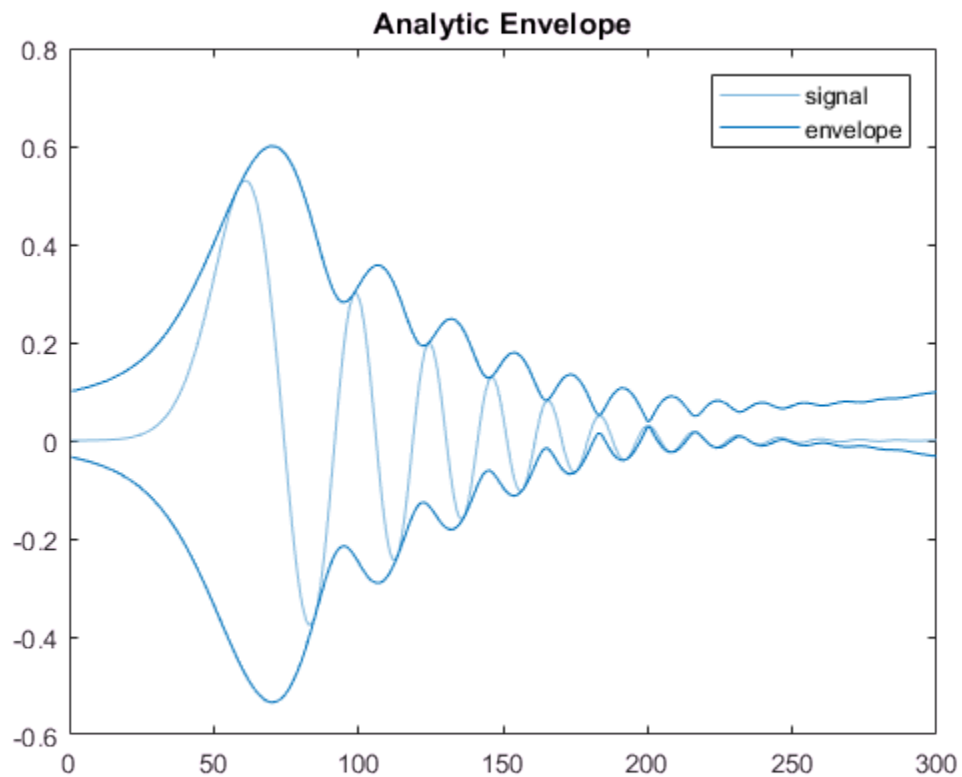

Compute the analytic envelope of the signal using a 50-tap Hilbert filter.

```
envelope(z,50,'analytic')
```

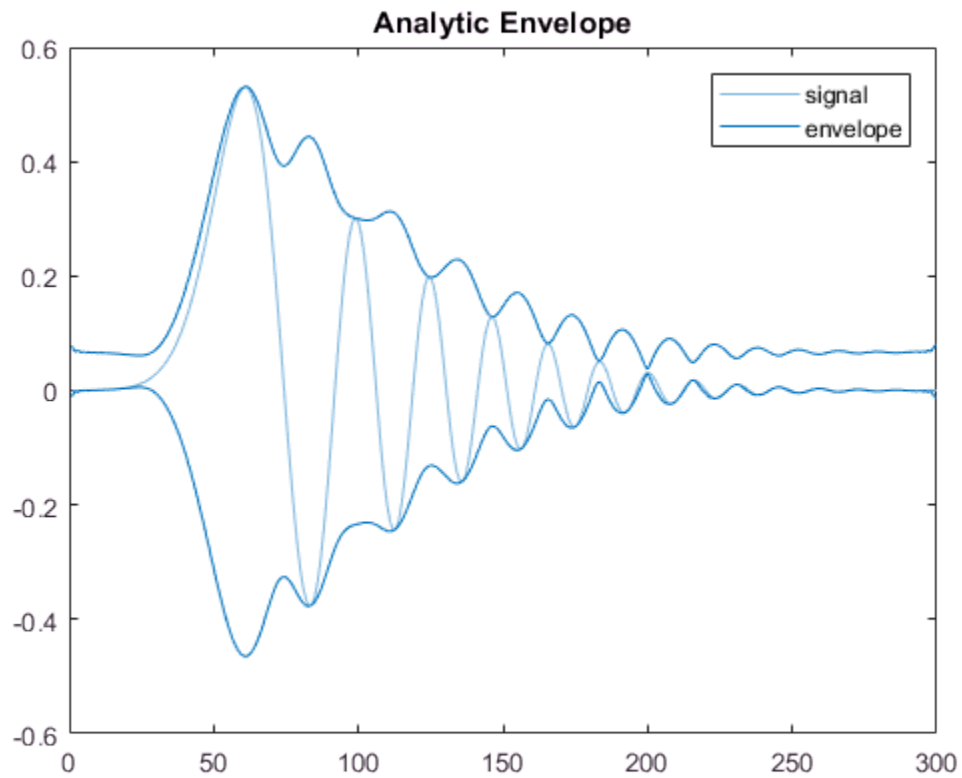

Compute the RMS envelope of the signal using a 40-sample moving window. Plot the result.

```
envelope(z,40,'rms')
```

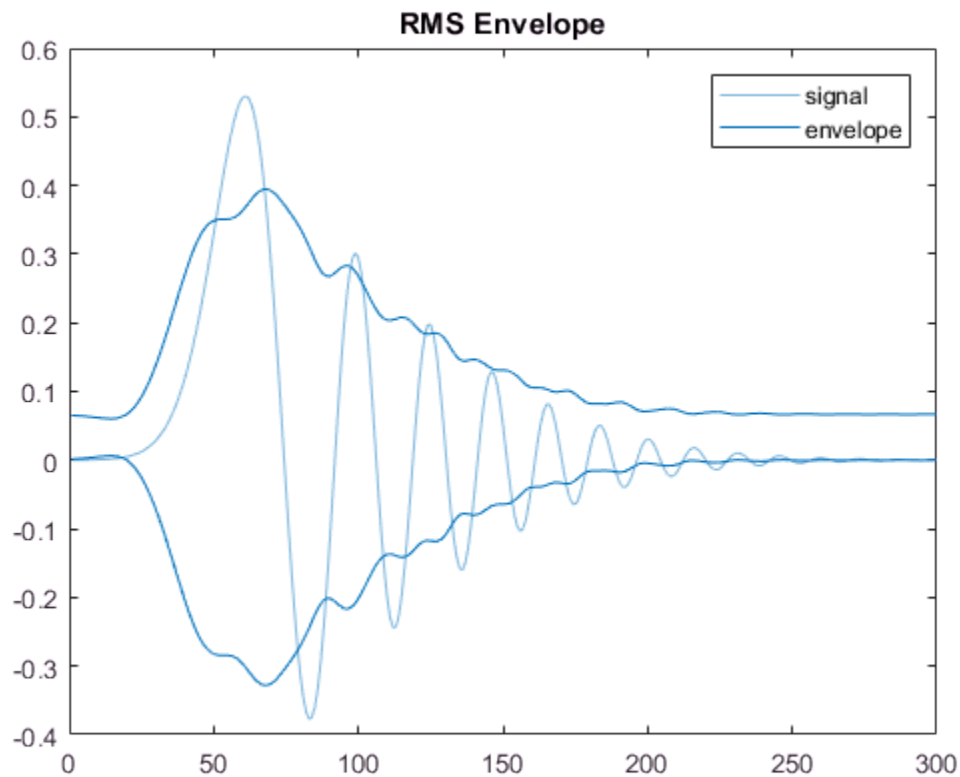

Determine the peak envelopes. Use spline interpolation with not-a-knot conditions over local maxima separated by at least 10 samples.

```
envelope(z,10,'peak')
```

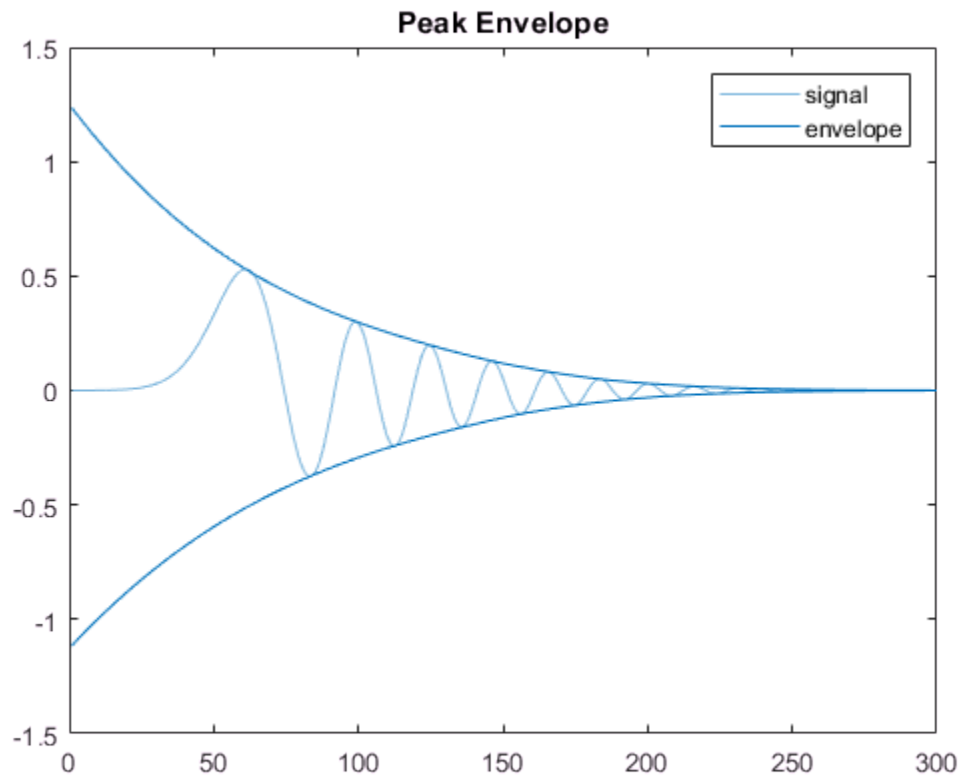

- “Envelope Extraction Using the Analytic Signal”

Input Arguments

x — Input sequence

vector | matrix

Input sequence, specified as a vector or matrix. If **x** is a vector, it is treated as a single channel. If **x** is a matrix, then `envelope` computes the envelope estimates independently for each column. All elements of **x** must be finite.

Example: `cos(pi/4*(0:159))+randn(1,160)` is a single-channel row-vector signal.

Example: `cos(pi./[4;2]*(0:159))'+randn(160,2)` is a two-channel signal.

Data Types: `single` | `double`

f1 — Hilbert filter length

positive integer scalar

Hilbert filter length, specified as a positive integer scalar. The filter is created by windowing an ideal brick-wall filter with a Kaiser window of length `f1` and shape parameter $\beta = 8$.

Data Types: `single` | `double`

w1 — Window length

positive integer scalar

Window length, specified as a positive integer scalar.

Data Types: `single` | `double`

np — Peak separation

positive integer scalar

Peak separation, specified as a positive integer scalar.

Data Types: `single` | `double`

Output Arguments

yupper, ylower — Upper and lower signal envelopes

vectors | matrices

Upper and lower signal envelopes, returned as vectors or matrices.

Extended Capabilities

C/C++ Code Generation

Generate C and C++ code using MATLAB® Coder™.

Usage notes and limitations:

Plotting is supported for simulation only. It is not supported in standalone code.

See Also

See Also

`findpeaks` | `hilbert` | `movmax` | `movmean` | `movmin` | `rms`

Topics

“Envelope Extraction Using the Analytic Signal”

Introduced in R2015b

equiripple

Equiripple single-rate FIR filter from specification object

Syntax

```
hd = design(d,'equiripple')  
hd = design(d,'equiripple',Name,Value)
```

Description

`hd = design(d,'equiripple')` designs an equiripple FIR digital filter using the specifications supplied in the object `d`. Equiripple filter designs minimize the maximum ripple in the passbands and stopbands.

`hd = design(d,'equiripple',Name,Value)` returns an equiripple FIR filter where you specify design options as `Name,Value` pairs.

To determine the available design options, use `designopts` with the specification object and the design method as input arguments as shown.

```
designopts(d,'method')
```

For complete help about using `equiripple`, refer to the command line help system. For example, to get specific information about using `equiripple` with `d`, the specification object, enter the following at the MATLAB prompt.

```
help(d,'equiripple')
```

Examples

Lowpass Equiripple Filter

Create a lowpass equiripple filter. Assume the data is sampled at 10 kHz. The passband frequency is 500 Hz and the stopband frequency of 700 Hz. The desired passband ripple

is 1 dB with 60 dB of stopband attenuation. Use FVTool to display the magnitude response of the filter.

```
Fs = 10000;
```

```
Hd = fdesign.lowpass('Fp,Fst,Ap,Ast',500,700,1,60,Fs);  
d = design(Hd,'equiripple');
```

```
fvtool(d)
```

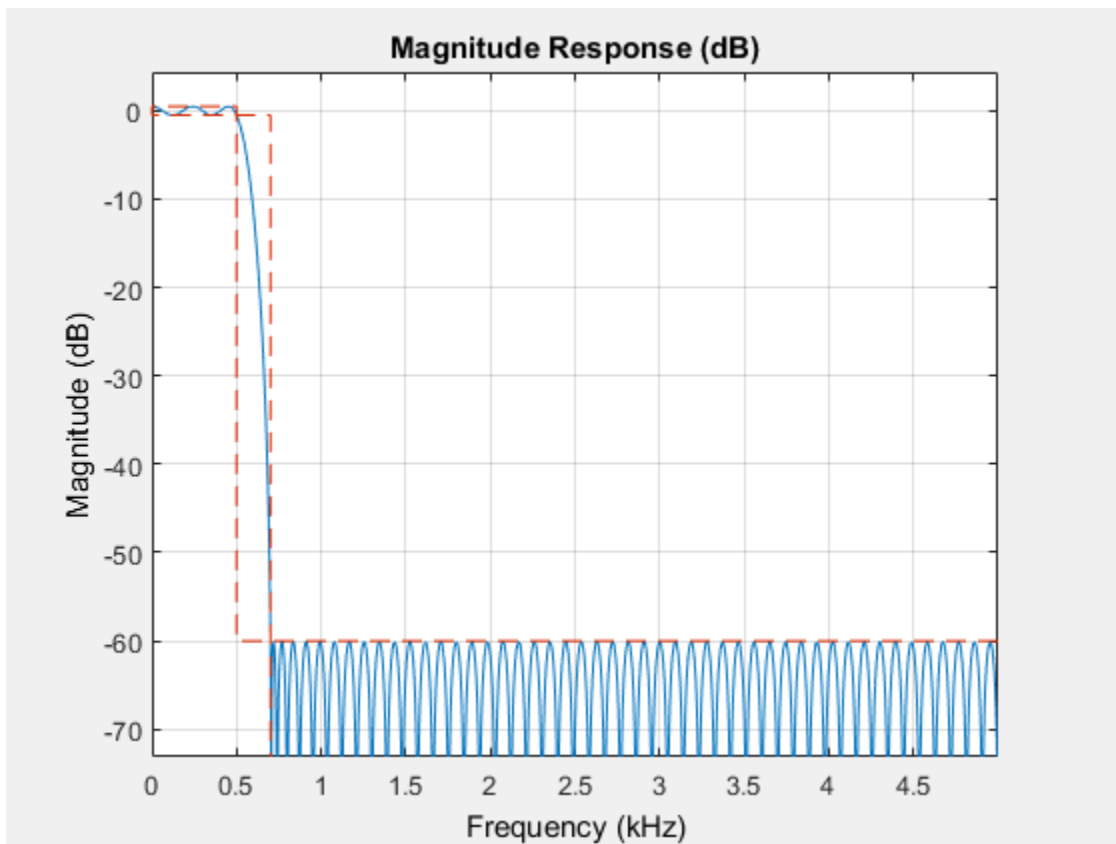

Design a lowpass equiripple filter with direct-form transposed structure and a density factor of 20.

```
df = design(Hd,'equiripple','FilterStructure','dffirt','DensityFactor',20);
```

`fvtool(df)`

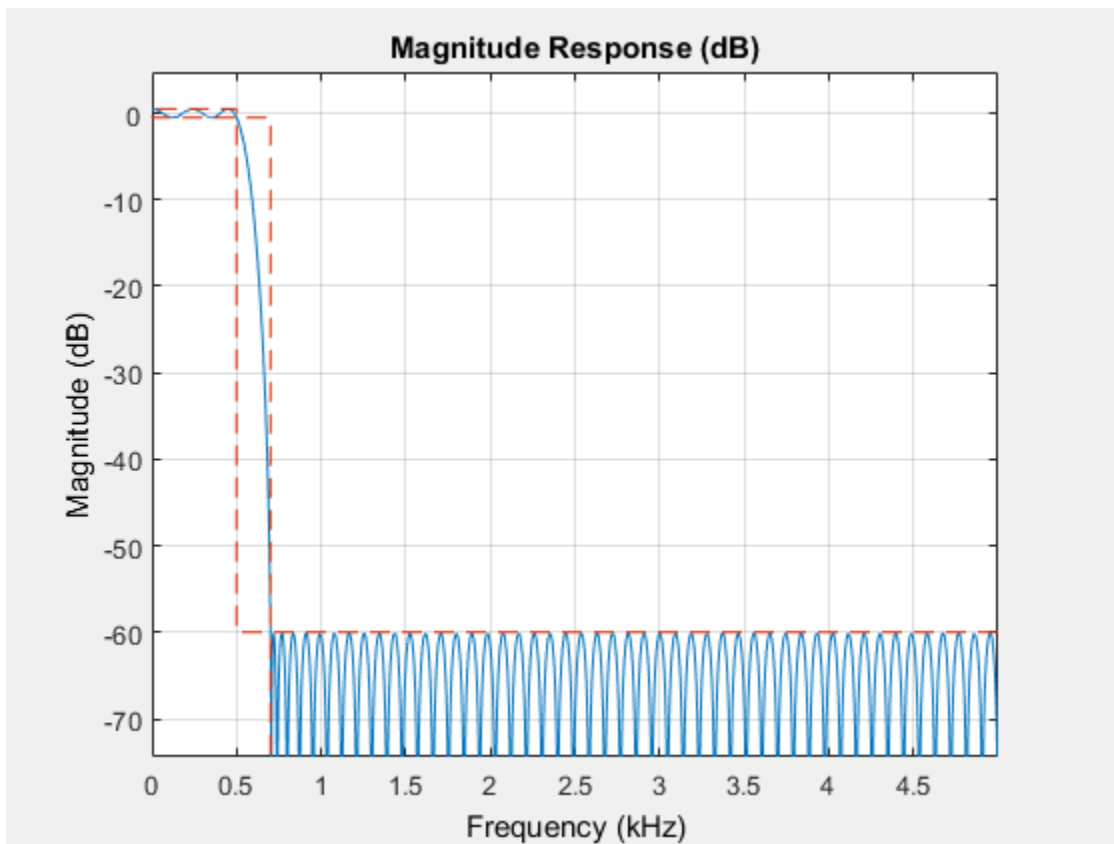

See Also

See Also

Apps
Filter Designer

Functions

designfilt | fdesign

Introduced in R2009a

eqtflength

Equalize lengths of transfer function's numerator and denominator

Syntax

```
[b,a] = eqtflength(num,den)
[b,a,n,m] = eqtflength(num,den)
```

Description

`[b,a] = eqtflength(num,den)` modifies the vector `num` and/or the vector `den`, so that the resulting output vectors `b` and `a` have the same length. The input vectors `num` and `den` may have different lengths. The vector `num` represents the numerator polynomial of a given discrete-time transfer function, and the vector `den` represents its denominator. The resulting numerator `b` and denominator `a` represent the same discrete-time transfer function, but these vectors have the same length.

`[b,a,n,m] = eqtflength(num,den)` modifies the vectors as above and also returns the numerator order `n` and the denominator `m`, not including any trailing zeros.

Use `eqtflength` to obtain a numerator and denominator of equal length before applying transfer function conversion functions such as `tf2ss` and `tf2zp` to discrete-time models.

Examples

```
num = [1 0.5];
den = [1 0.75 0.6 0];
[b,a,n,m] = eqtflength(num,den);
```

Algorithms

`eqtflength(num,den)` appends zeros to either `num` or `den` as necessary. If both `num` and `den` have trailing zeros in common, these are removed.

See Also

tf2ss | tf2zp

Introduced before R2006a

falltime

Fall time of negative-going bilevel waveform transitions

Syntax

```
F = falltime(X)
F = falltime(X,FS)
F = falltime(X,T)
[F,LT,UT] = falltime(...)
[F,LT,UT,LL,UL] = falltime(...)
[...] = falltime(...,Name,Value)
falltime(...)
```

Description

`F = falltime(X)` returns a vector, `F`, containing the time each transition of the bilevel waveform, `X`, takes to cross from the 90% to 10% reference levels. See “Percent Reference Levels” on page 1-561. To determine the transitions, `falltime` estimates the state levels of the input waveform by a histogram method. `falltime` identifies all regions, which cross the lower-state boundary of the high state and the upper-state boundary of the low state. The low-state and high-state boundaries are expressed as the state level plus or minus a multiple of the difference between the state levels. See “State-Level Tolerances” on page 1-562. Because `falltime` uses interpolation, `F` may contain values that do not correspond to sampling instants of the bilevel waveform, `X`.

`F = falltime(X,FS)` specifies the sampling frequency in hertz. The sampling frequency determines the sample instants corresponding to the elements in `X`. The first sample instant in `X` corresponds to `t=0`. Because `falltime` uses interpolation, `F` may contain values that do not correspond to sampling instants of the bilevel waveform, `X`.

`F = falltime(X,T)` specifies the sample instants, `T`, as a vector with the same number of elements as `X`.

`[F,LT,UT] = falltime(...)` returns vectors, `LT` and `UT`, whose elements correspond to the time instants where `X` crosses the lower and upper percent reference levels.

`[F,LT,UT,LL,UL] = falltime(...)` returns the levels, LL and UL, corresponding to the lower- and upper-percent reference levels.

`[...] = falltime(...,Name,Value)` returns the fall times with additional options specified by one or more Name,Value pair arguments.

`falltime(...)` plots the signal and darkens the regions of each transition where fall time is computed. The plot marks the lower and upper crossings and the associated reference levels. The state levels and the associated lower- and upper-state boundaries are also displayed.

Input Arguments

X

Bilevel waveform. X is a real-valued row or column vector.

FS

Sample rate in hertz.

T

Vector of sample instants. The length of T must equal the length of the bilevel waveform, X.

Name-Value Pair Arguments

'PercentReferenceLevels'

Reference levels as a percentage of the waveform amplitude. The low-state level is defined to be 0 percent. The high-state level is defined to be 100 percent. See “Percent Reference Levels” on page 1-561. 'PercentReferenceLevels' is a 2-element real row vector whose elements correspond to the lower- and upper-percent reference levels.

Default: [10 90]

'StateLevels'

Low and high-state levels. Specifies the levels to use for the low- and high-state levels as a 2-element real-valued row vector whose first and second elements correspond to the low- and high-state levels.

'Tolerance'

Tolerance levels (lower- and upper-state boundaries) expressed as a percentage. See “State-Level Tolerances” on page 1-562.

Default: 2

Output Arguments

F

Fall times. **F** is a vector containing the duration of each negative-going transition. If you specify the sampling rate, **FS**, or the sampling instants, **T**, fall times are in seconds. If you do not specify a sampling rate, or sampling instants, fall times are in samples.

LT

Instants when negative-going transition crosses the lower-reference level. By default, the lower-reference level is the 10% reference level. You can change the default reference levels by specifying the '**PercentReferenceLevels**' name-value pair.

UT

Instants when negative-going transition crosses the upper-reference level. By default, the upper reference level is the 90% reference level. You can change the default reference levels by specifying the '**PercentReferenceLevels**' name-value pair.

LL

Lower-reference level in waveform amplitude units. **LL** is a vector containing the waveform values corresponding to the lower-reference level in each negative-going transition. By default, the lower-reference level is the 10% reference level. You can change the default reference levels by specifying the '**PercentReferenceLevels**' name-value pair.

UL

Upper-reference level in waveform amplitude units. **UL** is a vector containing the waveform values corresponding to the upper-reference level in each negative-going transition. By default, the upper-reference level is the 90% reference level. You can change the default reference levels by specifying the '**PercentReferenceLevels**' name-value pair.

Examples

Fall Time of Bilevel Waveform

Determine the fall time in samples for a 2.3 V clock waveform.

Load the 2.3 V clock data. Determine the fall time in samples. Use the default 10% and 90% percent reference levels. Plot the waveform and annotate the fall time.

```
load('negtransitionex.mat','x')
```

```
falltime(x)
```

```
ans = 0.7200
```

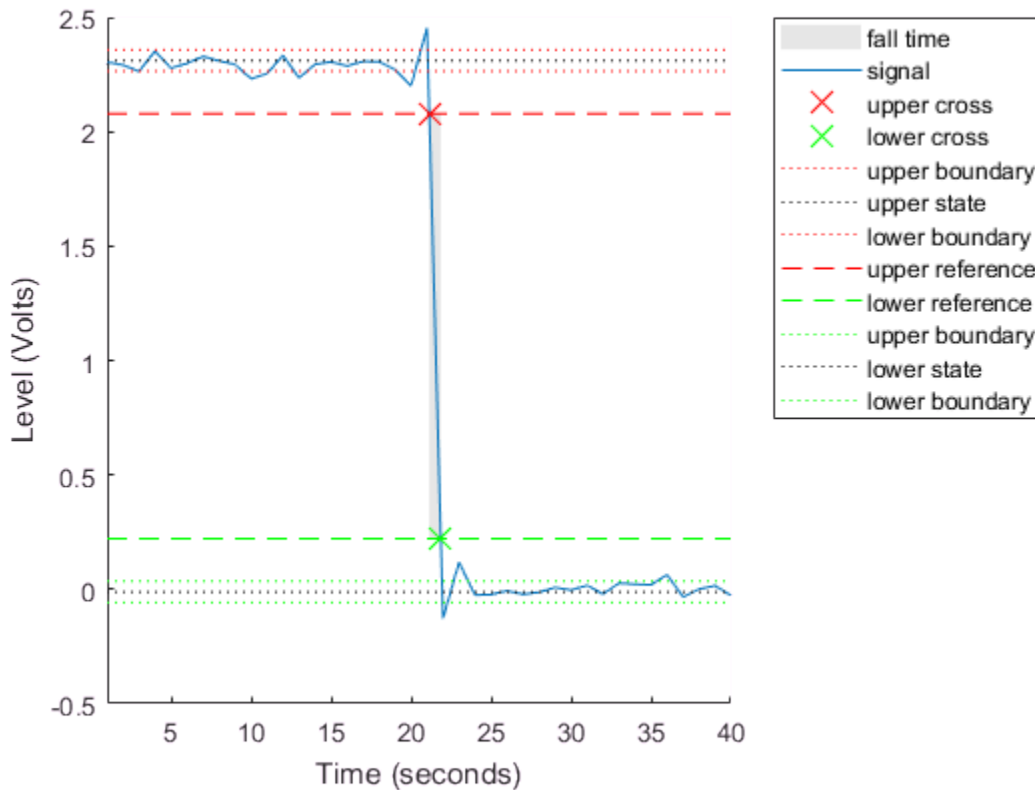

Fall Time with 20% and 80% Reference Levels

Determine the fall time in a 2.3 V clock waveform sampled at 4 MHz. Compute the fall time using the 20% and 80% reference levels.

Load the 2.3 V clock data with sampling instants. Determine the fall time using 20% and 80% reference levels. Plot the waveform and annotate the fall time.

```
load('negtransitionex.mat','x','t')
falltime(x,'PercentReferenceLevels',[20 80])
ans = 0.5400
```

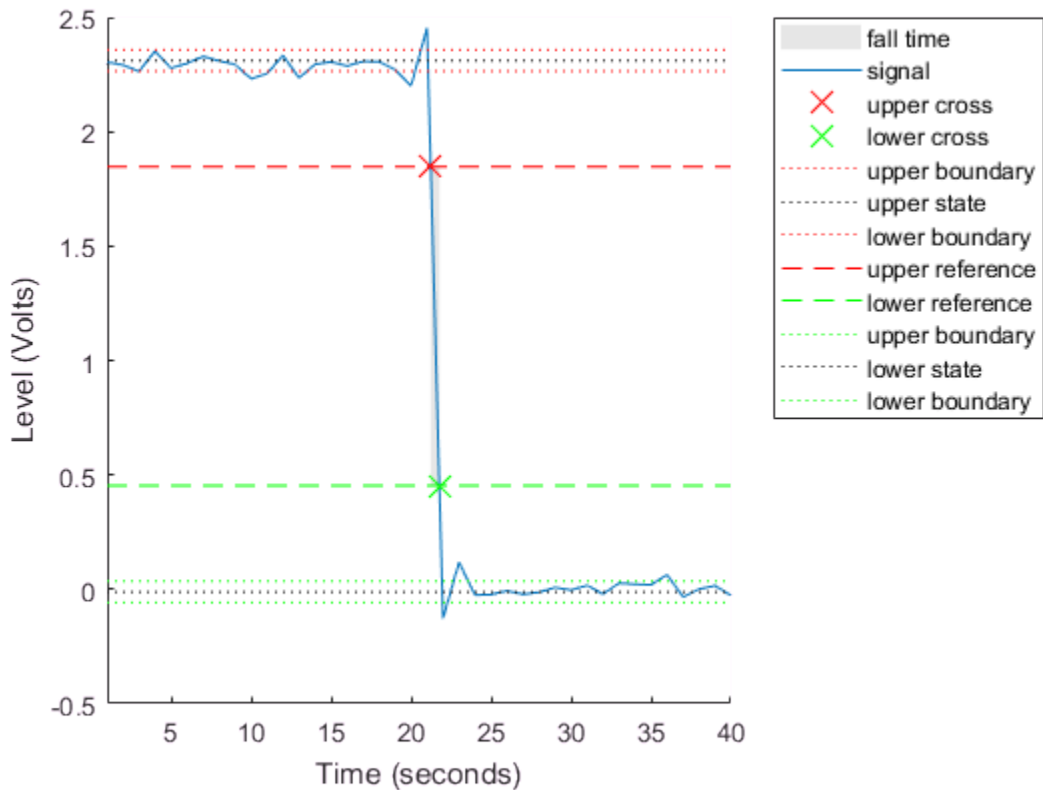

Falltime, Reference-Level Instants, and Reference Levels

Determine the fall time, reference-level instants, and reference levels in a 2.3 V clock waveform sampled at 4 MHz.

Load the 2.3 V clock waveform along with the sampling instants.

```
load('negtransitionex.mat','x','t')
```

Determine the fall time, reference-level instants, and reference levels.

```
[f,lt,ut,ll,ul] = falltime(x,t);
```

Plot the waveform with the upper and lower reference levels and reference level instants. Show that the fall time is the difference between the lower- and upper-reference level instants.

```
plot(t,x)
```

```
xlabel('seconds')  
ylabel('Volts')
```

```
hold on  
plot([lt ut],[ll ul],'ro')  
hold off
```

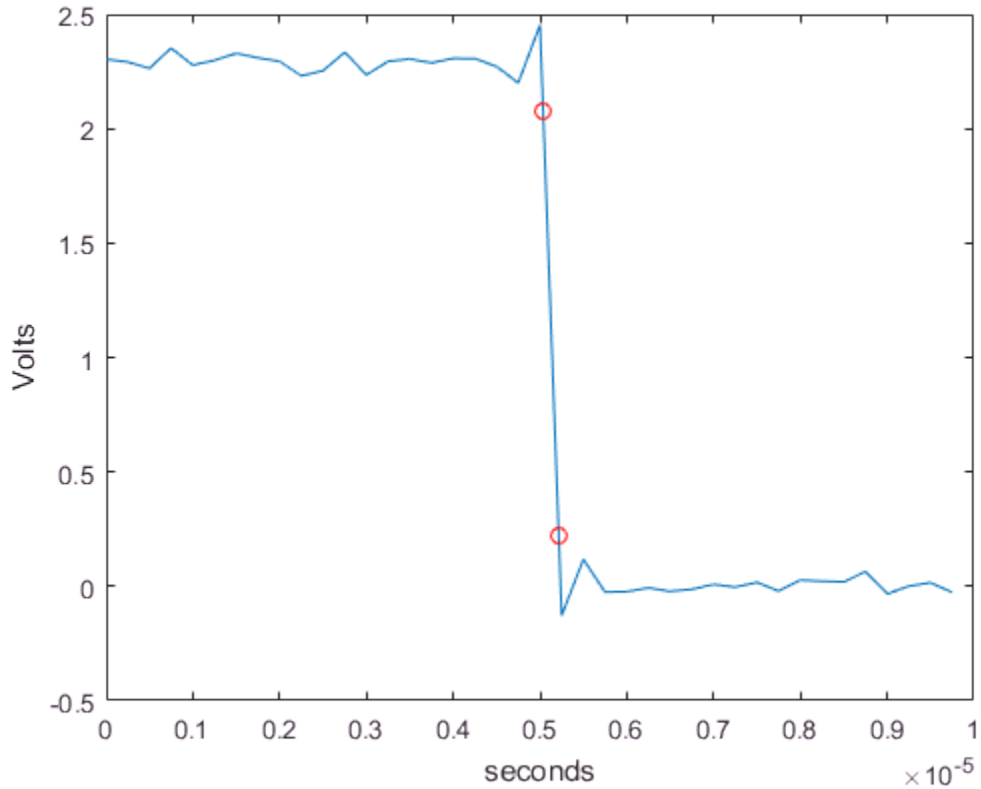

```
fprintf('Rise time is %g seconds.',lt-ut)
```

```
Rise time is 1.8e-07 seconds.
```

Definitions

Negative-Going Transition

A negative-going transition in a bilevel waveform is a transition from the high-state level to the low-state level. If the waveform is differentiable in the neighborhood of the

transition, an equivalent definition is a transition with a negative first derivative. The following figure shows a negative-going transition.

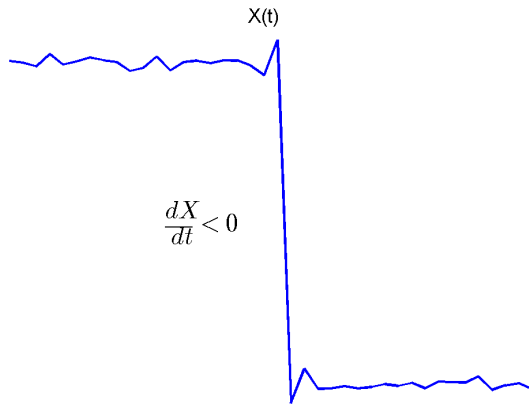

In the preceding figure, the amplitude values of the waveform are not displayed because a negative-going transition does not depend on the actual waveform values. A negative-going transition is defined by the direction of the transition.

Percent Reference Levels

If S_l is the low state, S_h is the high state, and U is the *upper*-percent reference level. The waveform value corresponding to the upper percent reference level is

$$S_l + \frac{U}{100}(S_h - S_l).$$

If L is the *lower* percent reference level, the waveform value corresponding to the lower percent reference level is

$$S_l + \frac{L}{100}(S_h - S_l).$$

State-Level Tolerances

Each state level can have associated lower- and upper-state boundaries. These state boundaries are defined as the state level plus or minus a scalar multiple of the difference between the high state and the low state. To provide a useful tolerance region, the scalar is typically a small number such as 2/100 or 3/100. In general, the $\alpha\%$ region for the low state is defined as

$$S_1 \pm \frac{\alpha}{100}(S_2 - S_1),$$

where S_1 is the low-state level and S_2 is the high-state level. Replace the first term in the equation with S_2 to obtain the $\alpha\%$ tolerance region for the high state.

The following figure illustrates lower and upper 2% state boundaries (tolerance regions) for a positive-polarity bilevel waveform. The red dashed lines indicate the estimated state levels.

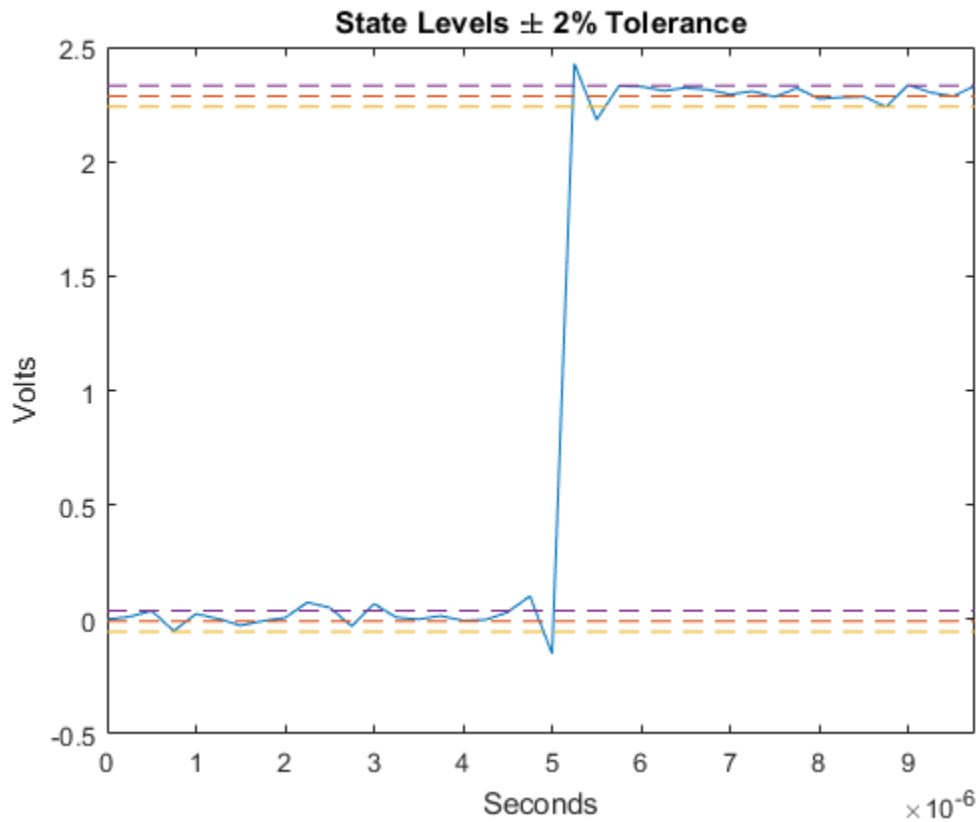

References

- [1] *IEEE Standard on Transitions, Pulses, and Related Waveforms*, IEEE Standard 181, 2003, pp. 15–17.

See Also

See Also

risetime | slewrate | statelevels

Introduced in R2012a

fdesign

Filter specification object

Syntax

```
filtSpecs = fdesign.response  
filtSpecs = fdesign.response(spec)  
filtSpecs = fdesign.response(...,Fs)  
filtSpecs = fdesign.response(...,magunits)
```

Description

Filter Specification Objects

`filtSpecs = fdesign.response` returns a filter specification object, `filtSpecs`, of filter response *response*. To create filters from `filtSpecs`, use one of the design methods listed in “Using Filter Design Methods with Specification Objects” on page 1-572.

Note: Several of the filter response types described below are only available if your installation includes the DSP System Toolbox. The DSP System Toolbox significantly expands the functionality available for the specification, design, and analysis of filters.

Here is how you design filters using `fdesign`.

- 1 Use `fdesign.response` to construct a filter specification object.
- 2 Use `designmethods` to determine which filter design methods work for your new filter specification object.
- 3 Use `design` to apply your filter design method from step 2 to your filter specification object to construct a filter object.
- 4 Use `FVTool` to inspect and analyze your filter object.

Note `fdesign` does not create filters. `fdesign` returns a filter specification object that contains the specifications for a filter, such as the passband cutoff or attenuation in the stopband. To design a filter from a filter specification object `filtSpecs`, use `filtSpecs` with a filter design method such as `butter` — `IIRbutter = design(filtSpecs, 'butter', 'SystemObject', true)`.

response can be one of the entries in the following table that specify the filter response desired, such as a bandstop filter or an interpolator.

fdesign Response Method	Description
<code>arbgrpdelay</code>	<code>fdesign.arbgrpdelay</code> creates an object to specify allpass arbitrary group delay filters. Requires the DSP System Toolbox
<code>arbmag</code>	<code>fdesign.arbmag</code> creates an object to specify IIR filters that have arbitrary magnitude responses defined by the input arguments.
<code>arbmagnphase</code>	<code>fdesign.arbmagnphase</code> creates an object to specify IIR filters that have arbitrary magnitude and phase responses defined by the input arguments. Requires the DSP System Toolbox.
<code>audioweighting</code>	<code>fdesign.audioweighting</code> creates a filter specification object for audio weighting filters. The supported audio weighting types are: A, C, C-message, ITU-T 0.41, and ITU-R 468-4 weighting. Requires the DSP System Toolbox
<code>bandpass</code>	<code>fdesign.bandpass</code> creates an object to specify bandpass filters.
<code>bandstop</code>	<code>fdesign.bandstop</code> creates an object to specify bandstop filters.
<code>ciccomp</code>	<code>fdesign.ciccomp</code> creates an object to specify filters that compensate for the CIC decimator or interpolator response curves. Requires the DSP System Toolbox.
<code>comb</code>	<code>fdesign.comb</code> creates an object to specify a notching or peaking comb filter. Requires the DSP System Toolbox.
<code>decimator</code>	<code>fdesign.decimator</code> creates an object to specify decimators. Requires the DSP System Toolbox

fdesign Response Method	Description
differentiator	<code>fdesign.differentiator</code> creates an object to specify an FIR differentiator filter.
fracdelay	<code>fdesign.fracdelay</code> creates an object to specify fractional delay filters. Requires the DSP System Toolbox.
halfband	<code>fdesign.halfband</code> creates an object to specify halfband filters. Requires the DSP System Toolbox.
highpass	<code>fdesign.highpass</code> creates an object to specify highpass filters.
hilbert	<code>fdesign.hilbert</code> creates an object to specify an FIR Hilbert transformer.
interpolator	<code>fdesign.interpolator</code> creates an object to specify interpolators. Requires the DSP System Toolbox.
isinchp	<code>fdesign.isinchp</code> creates an object to specify an inverse sinc highpass filter. Requires the DSP System Toolbox.
isinclp	<code>fdesign.isinclp</code> creates an object to specify an inverse sinc lowpass filters. Requires the DSP System Toolbox.
lowpass	<code>fdesign.lowpass</code> creates an object to specify lowpass filters.
notch	<code>fdesign.notch</code> creates an object to specify notch filters. Requires the DSP System Toolbox.
nyquist	<code>fdesign.nyquist</code> creates an object to specify Nyquist filters. Requires the DSP System Toolbox.
octave	<code>fdesign.octave</code> creates an object to specify octave and fractional octave filters. Requires the DSP System Toolbox.
parameq	<code>fdesign.parameq</code> creates an object to specify parametric equalizer filters. Requires the DSP System Toolbox.
peak	<code>fdesign.peak</code> creates an object to specify peak filters. Requires the DSP System Toolbox.
polysrc	<code>fdesign.polysrc</code> creates an object to specify polynomial sample-rate converter filters. Requires the DSP System Toolbox.

fdesign Response Method	Description
rsrc	<code>fdesign.rsrc</code> creates an object to specify rational-factor sample-rate convertors. Requires the DSP System Toolbox.

Use the doc `fdesign.response` syntax at the MATLAB prompt to get help on a specific structure. Using `doc` in a syntax like

```
doc fdesign.lowpass
doc fdesign.bandstop
```

gets more information about the `lowpass` or `bandstop` structure objects.

Each `response` has a property `Specification` that defines the specifications to use to design your filter. You can use defaults or specify the `Specification` property when you construct the specifications object.

Using the `Specification` property, you can provide filter constraints such as the filter order or the passband attenuation to use when you construct your filter from the specification object.

Properties

`fdesign` returns a filter specification object. Every filter specification object has the following properties.

Property Name	Default Value	Description
Response	Depends on the chosen type	Defines the type of filter to design, such as an interpolator or bandpass filter. This is a read-only value.
Specification	Depends on the chosen type	Defines the filter characteristics used to define the desired filter performance, such as the cutoff frequency <code>FC</code> or the filter order <code>N</code> .
Description	Depends on the filter type you choose	Contains descriptions of the filter specifications used to define the object, and the filter specifications

Property Name	Default Value	Description
		you use when you create a filter from the object. This is a read-only value.
NormalizedFrequency	Logical true	Determines whether the filter calculation uses normalized frequency from 0 to 1, or the frequency band from 0 to $F_s/2$, the sampling frequency. Accepts either true or false without single quotation marks. Audio weighting filters do not support normalized frequency.

In addition to these properties, filter specification objects may have other properties as well, depending on whether they design single-rate filters or multirate filters.

Added Properties for Multirate Filters	Description
DecimationFactor	Specifies the amount to decrease the sampling rate. Always a positive integer.
InterpolationFactor	Specifies the amount to increase the sampling rate. Always a positive integer.
PolyphaseLength	Polyphase length is the length of each polyphase subfilter that composes the decimator or interpolator or rate-change factor filters. Total filter length is the product of p_1 and the rate change factors. p_1 must be an even integer.

`filtSpecs = fdesign.response(spec)`. In `spec`, you specify the variables to use that define your filter design, such as the passband frequency or the stopband attenuation. The specifications are applied to the filter design method you choose to design your filter.

For example, when you create a default lowpass filter specification object, `fdesign.lowpass` sets the passband frequency F_p , the stopband frequency F_{st} , the stopband attenuation A_{st} , and the passband ripple A_p :

```
filtSpecs = fdesign.lowpass
```

Use without a terminating semicolon to display the filter specifications.

The default specification 'Fp,Fst,Ap,Ast' is only one of the possible specifications for `fdesign.lowpass`. To see all available specifications:

```
filtSpecs = fdesign.lowpass;  
set(filtSpecs, 'Specification')
```

The DSP System Toolbox software supports all available specification options. The Signal Processing Toolbox supports a subset of the specification options. See the reference pages for the filter specification object to determine which specification option your installation supports.

One important note is that the specification option you choose determines which design methods apply to the filter specifications object.

Specifications that do not contain the filter order result in minimum order designs when you invoke the `design` method:

```
filtSpecs = fdesign.lowpass;           % Specification is 'Fp,Fst,Ap,Ast'  
FIRReq = design(filtSpecs, 'equiripple', 'SystemObject', true);  
length(FIRReq.Numerator)           % Returns 43. The filter order is 42  
fvtool(FIRReq)                     % View magnitude
```

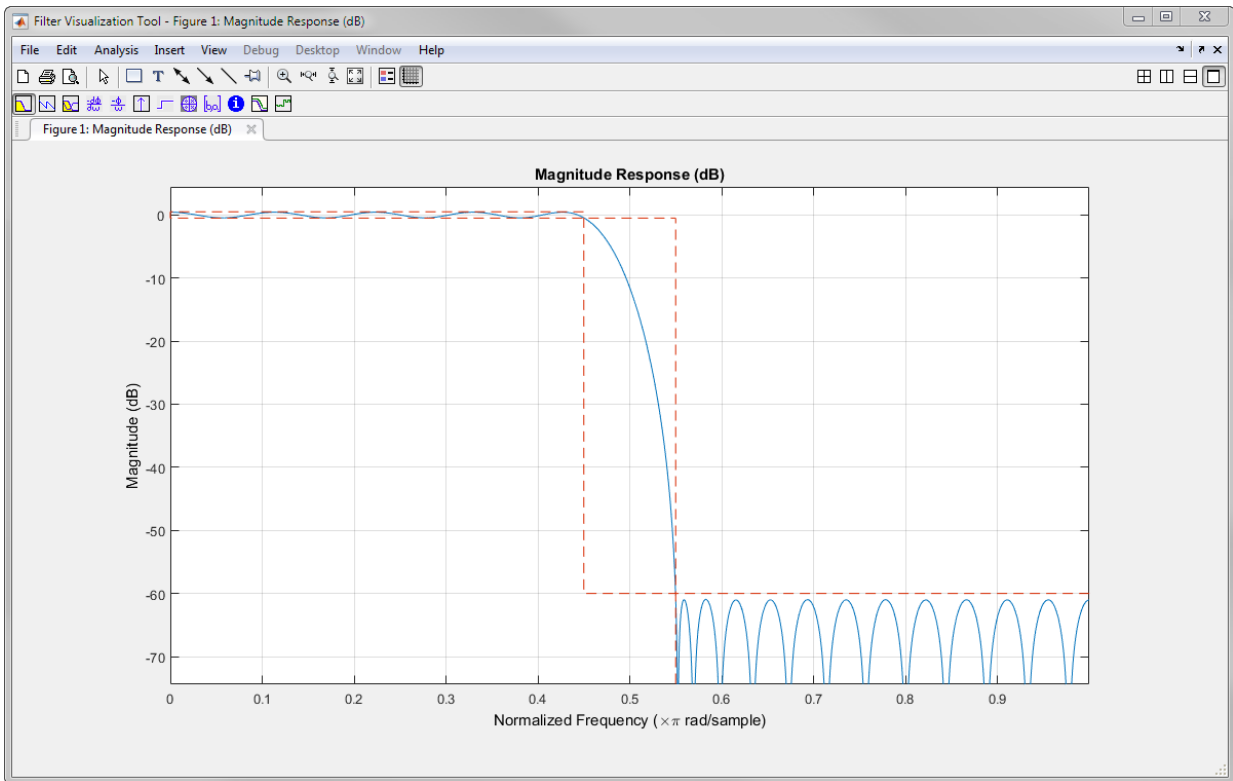
`filtSpecs = fdesign.response(...,Fs)` specifies the sampling frequency in Hz to use in the filter specifications. The sampling frequency is a scalar trailing all other input arguments. If you specify a sampling frequency, all frequency specifications are in Hz.

`filtSpecs = fdesign.response(...,magunits)` specifies the units for any magnitude specification you provide in the input arguments. `magunits` can be one of the following options:

- 'linear' — specify the magnitude in linear units
- 'dB' — specify the magnitude in decibels
- 'squared' — specify the magnitude in power units

When you omit the `magunits` argument, `fdesign` assumes that all magnitudes are in decibels. Note that `fdesign` stores all magnitude specifications in decibels (converting to decibels when necessary) regardless of how you specify the magnitudes.

Using Filter Design Methods with Specification Objects

After you create a filter specification object, you use a filter design method to implement your filter with a selected algorithm. Use `designmethods` to determine valid design methods for your filter specification object.

```
filtSpecs = fdesign.lowpass('N,Fc,Ap,Ast',10,0.2,0.5,40);
designmethods(filtSpecs)
% Design FIR equiripple filter
FIRReq = design(filtSpecs,'equiripple','SystemObject',true);
```

When you use any of the design methods without providing an output argument, the resulting filter design appears in FVTool by default.

Along with filter design methods, `fdesign` works with supporting methods that help you create filter specification objects or determine which design methods work for a given specifications object.

Supporting Function	Description
<code>setspecs</code>	Set all of the specifications simultaneously.
<code>designmethods</code>	Return the design methods.
<code>designopts</code>	Return the input arguments and default values that apply to a specifications object and method

You can set filter specification values by passing them after the `Specification` argument, or by passing the values without the `Specification`.

Filter object constructors take the input arguments in the same order as `setspecs` and `Specification`. Enter `doc setspecs` at the prompt for more information about using `setspecs`.

When the first input to `fdesign` is not a valid `Specification` option like `'N,Fc'`, `fdesign` assumes that the input argument is a filter specification and applies it using the default `Specification` option — `'Fp,Fst,Ap,Ast'` for a lowpass object, for example.

Examples

Design of Lowpass Filter

This example requires the DSP System Toolbox product.

Design a lowpass filter to be used on a signal sampled at 96 kHz. The passband of the filter extends up to 20 kHz. The stopband of the filter starts at 24 kHz. Specify a passband ripple of 0.01 dB and a stopband attenuation of 80 dB. Determine automatically the order required to meet the specifications.

Set up the filter design specifications and determine the available design algorithms.

```
Fs = 96e3;  
Fpass = 20e3;  
Fstop = 24e3;  
Apass = 0.01;  
Astop = 80;
```

```
filtSpecs = fdesign.lowpass(Fpass,Fstop,Apass,Astop,Fs);  
designmethods(filtSpecs)
```

```
Design Methods for class fdesign.lowpass (Fp,Fst,Ap,Ast):
```

```
butter  
cheby1  
cheby2  
ellip  
equiripple  
ifir  
kaiserwin  
multistage
```

Design an equiripple FIR filter and an elliptic IIR filter that meet the specifications. Measure the designs to verify that the filters satisfy the constraints.

```
lpFIR = design(filtSpecs, 'equiripple', 'SystemObject', true);  
lpIIR = design(filtSpecs, 'ellip', 'SystemObject', true);
```

```
FIRmeas = measure(lpFIR)  
IIRmeas = measure(lpIIR)
```

```
FIRmeas =
```

```
Sample Rate      : 96 kHz  
Passband Edge    : 20 kHz
```

```
3-dB Point      : 21.4297 kHz
6-dB Point      : 21.8447 kHz
Stopband Edge   : 24 kHz
Passband Ripple : 0.0092309 dB
Stopband Atten. : 80.6014 dB
Transition Width : 4 kHz
```

```
IIRmeas =
```

```
Sample Rate      : 96 kHz
Passband Edge    : 20 kHz
3-dB Point       : 20.5524 kHz
6-dB Point       : 20.7138 kHz
Stopband Edge    : 24 kHz
Passband Ripple  : 0.01 dB
Stopband Atten.  : 80 dB
Transition Width  : 4 kHz
```

Estimate and display the computational cost of each filter. The equiripple FIR filter requires many more coefficients than the elliptic IIR filter.

```
FIRcost = cost(lpFIR)
IIRcost = cost(lpIIR)
```

```
FIRcost =
```

```
struct with fields:
    NumCoefficients: 101
    NumStates: 100
    MultiplicationsPerInputSample: 101
    AdditionsPerInputSample: 100
```

```
IIRcost =
```

```
struct with fields:
    NumCoefficients: 20
    NumStates: 10
    MultiplicationsPerInputSample: 20
    AdditionsPerInputSample: 20
```

Visualize the resulting designs with FVTool to compare their properties.

```
fvttool(lpFIR,lpIIR,'Fs',Fs);
legend('FIR Equiripple','Elliptic IIR')
```

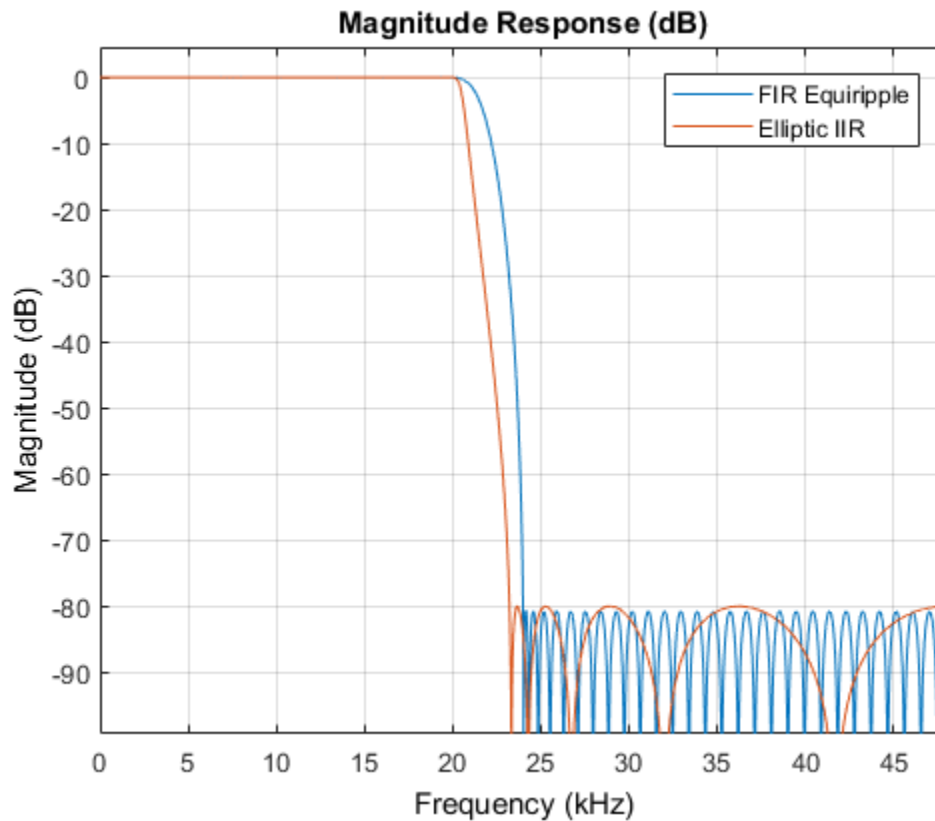

Design of Lowpass Decimator

This example requires the DSP System Toolbox product.

Design a 100-tap FIR lowpass decimator filter that reduces the sample rate of a signal from 60 kHz to 20 kHz. The passband of the filter extends up to 6 kHz. Specify a passband ripple of 0.01 dB and a stopband attenuation of 100 dB.

```
Fs = 60e3;  
N = 99;  
Fpass = 6e3;  
Apass = 0.01;  
Astop = 100;  
M = Fs/20e3;  
  
filtSpecs = fdesign.decimator(M, 'lowpass', 'N,Fp,Ap,Ast', N, Fpass, Apass, Astop, Fs);
```

Design the filter and display information about it.

```
decimFIR = design(filtSpecs, 'equiripple', 'SystemObject', true);  
info(decimFIR)
```

```
ans =
```

```
10×56 char array
```

```
'Discrete-Time FIR Multirate Filter (real)      '  
'-----'  
'Filter Structure      : Direct-Form FIR Polyphase Decimator'  
'Decimation Factor    : 3'  
'Polyphase Length     : 34'  
'Filter Length        : 100'  
'Stable               : Yes'  
'Linear Phase         : Yes (Type 2)'  
'  
'Arithmetic           : double'
```

Visualize the magnitude response of the filter.

```
fvtool(decimFIR, 'Fs', Fs)
```

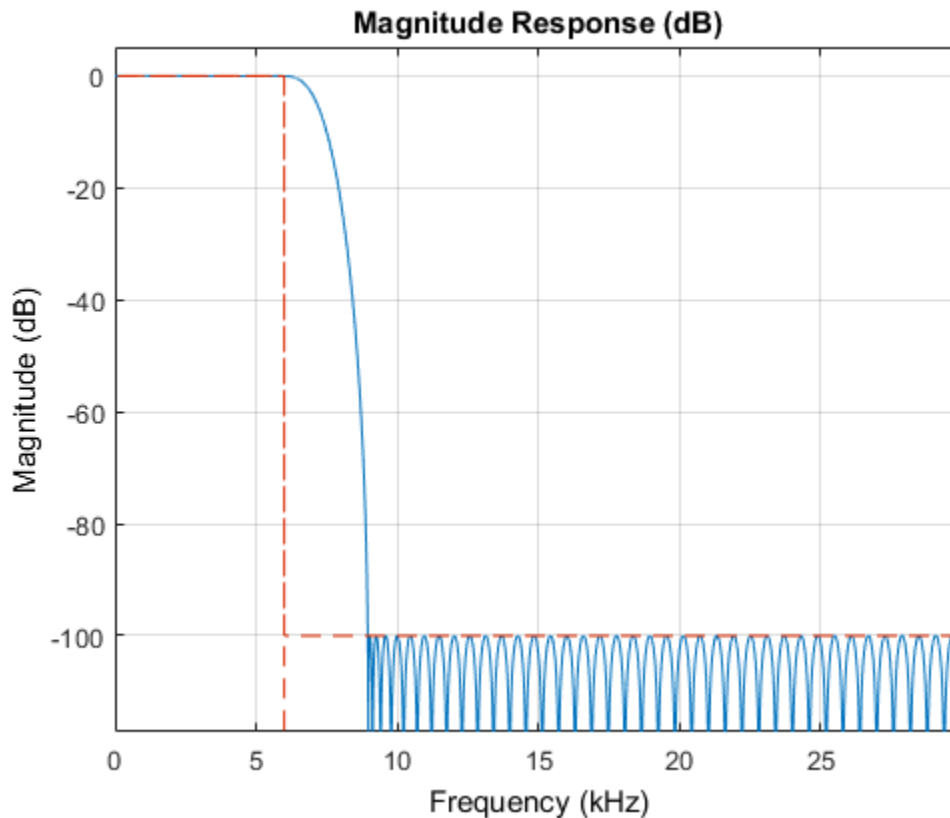

Lowpass Butterworth Filter Specification and Design

Use a filter specification object to construct a lowpass Butterworth filter with the default specification, 'Fp,Fst,Ap,Ast'. Specify a passband edge frequency of 0.4π rad/sample, a stopband frequency of 0.5π rad/sample, a passband ripple of 1 dB, and a stopband attenuation of 80 dB.

```
filtSpecs = fdesign.lowpass(0.4,0.5,1,80);
```

Determine which design methods apply to `filtSpecs`.

```
designmethods(filtSpecs)
```

Design Methods for class `fdesign.lowpass (Fp,Fst,Ap,Ast)`:

```
butter
cheby1
cheby2
ellip
equiripple
ifir
kaiserwin
multistage
```

You can use `filtSpecs` and the `butter` design method to design a Butterworth filter. Determine the available design options.

```
designoptions(filtSpecs, 'butter')
```

```
ans =
```

```
struct with fields:
    FilterStructure: {1×6 cell}
    SOSScaleNorm: 'ustring'
    SOSScaleOpts: 'fdopts.sosscaling'
    MatchExactly: {'passband' 'stopband'}
    SystemObject: 'bool'
DefaultFilterStructure: 'df2sos'
DefaultMatchExactly: 'stopband'
DefaultSOSScaleNorm: ''
DefaultSOSScaleOpts: [1×1 fdopts.sosscaling]
DefaultSystemObject: 0
```

The filter order necessary to meet a set of design constraints must also be rounded up to an integer value. This loosens some of the constraints, and, as a consequence, some design specifications are met while others are exceeded. The `'MatchExactly'` option allows you to match the passband or stopband exactly while exceeding the specification for the other band. Design the filter so that it matches the passband exactly.

```
IIRbutter = design(filtSpecs, 'butter', 'MatchExactly', 'passband', ...
    'SystemObject', true);
```

Use FVTool to visualize the magnitude response of the filter.

```
fvtool(IIRbutter)
```

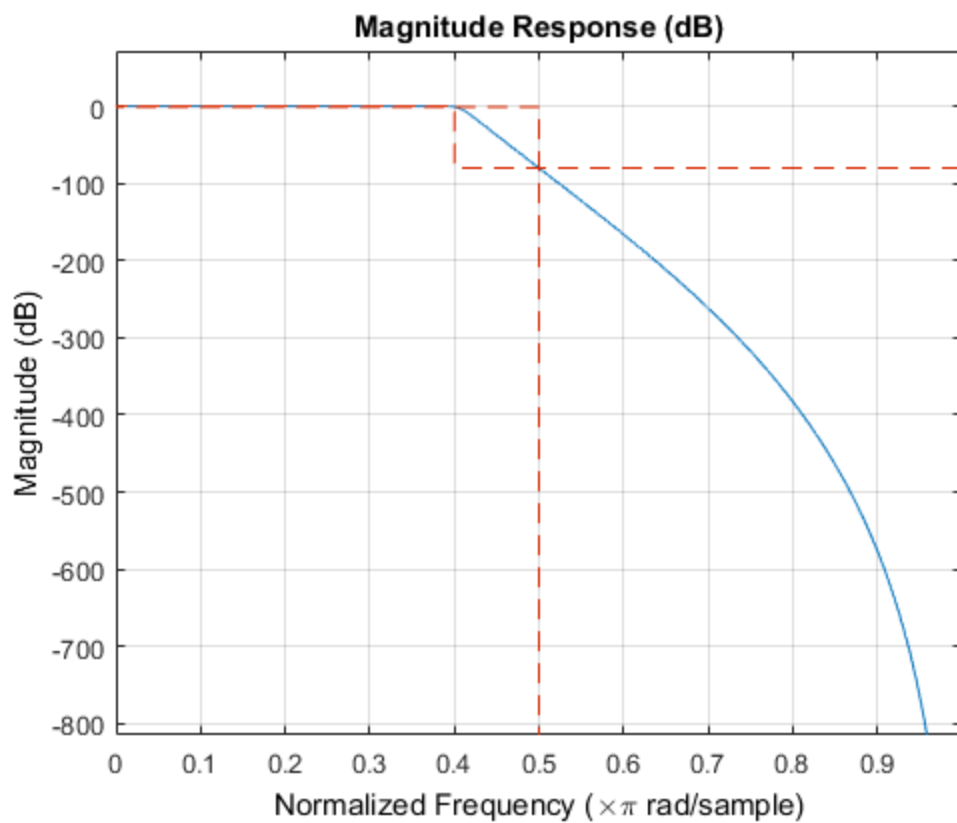

If you have the DSP System Toolbox software installed, the preceding figure appears with the filter specification mask.

See Also

See Also

Apps

Filter Designer

Functions

`designmethods` | `designopts` | `filterBuilder` | `fvtool`

Introduced in R2009a

fdesign.arbmag

Arbitrary response magnitude filter specification object

Syntax

```
D = fdesign.arbmag
D = fdesign.arbmag(SPEC)
D = fdesign.arbmag(SPEC,specvalue1,specvalue2,...)
D = fdesign.arbmag(specvalue1,specvalue2,specvalue3)
D = fdesign.arbmag(...,Fs)
```

Description

`D = fdesign.arbmag` constructs an arbitrary magnitude filter specification object `D`.

`D = fdesign.arbmag(SPEC)` initializes the `Specification` property to `SPEC`. The input argument `SPEC` must be one of the entries shown in the following table. Specification entries are not case sensitive.

Note: Specification entries marked with an asterisk require the DSP System Toolbox software.

- 'N,F,A' — Single band design (default)
- 'F,A,R' — Single band minimum order design *
- 'N,B,F,A' — Multiband design
- 'N,B,F,A,C' — Constrained multiband design *
- 'B,F,A,R' — Multiband minimum order design *
- 'Nb,Na,F,A' — Single band design *
- 'Nb,Na,B,F,A' — Multiband design *

The `SPEC` entries are defined as follows:

- **A** — Amplitude vector. Values in **A** define the filter amplitude at frequency points you specify in **f**, the frequency vector. If you use **A**, you must use **F** as well. Amplitude values must be real. For complex values designs, use `fdesign.arbmagnphase`.
- **B** — Number of bands in the multiband filter
- **C** — Constrained band flag. This enables you to constrain the passband ripple in your multiband design. You cannot constrain the passband ripple in all bands simultaneously.
- **F** — Frequency vector. Frequency values in specified in **F** indicate locations where you provide specific filter response amplitudes. When you provide **F**, you must also provide **A**.
- **N** — Filter order for FIR filters and the numerator and denominator orders for IIR filters.
- **Nb** — Numerator order for IIR filters
- **Na** — Denominator order for IIR filter designs
- **R** — Ripple

By default, this method assumes that all frequency specifications are supplied in normalized frequency.

Specifying Frequency and Amplitude Vectors

F and **A** are the input arguments you use to define the filter response desired. Each frequency value you specify in **F** must have a corresponding response value in **A**. The following table shows how **F** and **A** are related.

Define the frequency vector **F** as [0 0.25 0.3 0.4 0.5 0.6 0.7 0.75 1.0]

Define the response vector **A** as [1 1 0 0 0 0 0 1 1]

These specifications connect **F** and **A** as shown here:

F (Normalized Frequency)	A (Response Desired at F)
0	1
0.25	1
0.3	0
0.4	0
0.5	0

F (Normalized Frequency)	A (Response Desired at F)
0.6	0
0.7	0
0.75	1
1.0	1

Different specifications can have different design methods available. Use `designmethods` to get a list of design methods available for a given specification and filter specification object.

Use `designopts` to get a list of design options available for a filter specification object and a given design method. Enter `help(D,METHOD)` to get detailed help on the available design options for a given design method.

`D = fdesign.arbmag(SPEC,specvalue1,specvalue2,...)` initializes the specifications with `specvalue1`, `specvalue2`. Use `get(D,'Description')` for descriptions of the various specifications `specvalue1`, `specvalue2`, ... `specvalueN`.

`D = fdesign.arbmag(specvalue1,specvalue2,specvalue3)` uses the default specification 'N,F,A', setting the filter order, filter frequency vector, and the amplitude vector to the values `specvalue1`, `specvalue2`, and `specvalue3`.

`D = fdesign.arbmag(...,Fs)` specifies the sampling frequency in Hz. All other frequency specifications are also assumed to be in Hz when you specify `Fs`.

Examples

Design Multiband Arbitrary-Magnitude Filter

Use `fdesign.arbmag` to design a three-band filter.

- Define the frequency vector `F = [0 0.25 0.3 0.4 0.5 0.6 0.7 0.75 1.0]`.
- Define the response vector `A = [1 1 0 0 0 0 1 1]`.

```
N = 150;
B = 3;
F = [0 .25 .3 .4 .5 .6 .7 .75 1];
A = [1 1 0 0 0 0 1 1];
A1 = A(1:2);
A2 = A(3:7);
```

```
A3 = A(8:end);
F1 = F(1:2);
F2 = F(3:7);
F3 = F(8:end);
d = fdesign.arbmag('N,B,F,A',N,B,F1,A1,F2,A2,F3,A3);
Hd = design(d);
fvtool(Hd)
```

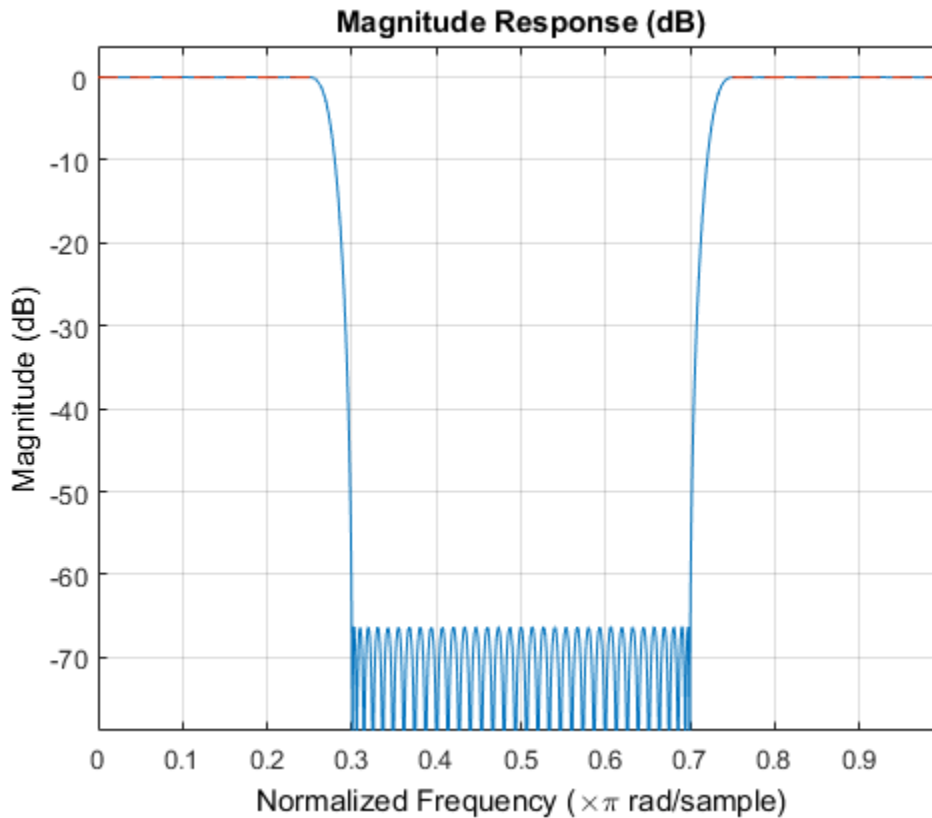

A response with two passbands -- one roughly between 0 and 0.25 and the second between 0.75 and 1 -- results from the mapping between F and A.

Design Single-Band Arbitrary-Magnitude Filter

Use `fdesign.arbmag` to design a single band equiripple filter.

Specify 100 frequency points.

```
n = 120;
f = linspace(0,1,100);

as = ones(1,100)-f*0.2;
absorb = [ones(1,30),1-0.6*bohmanwin(10)',ones(1,5), ...
          1-0.5*bohmanwin(8)',ones(1,47)];
a = as.*absorb;

d = fdesign.arbmag('N,F,A',n,f,a);
hd1 = design(d,'equiripple');
```

Design a minimum-phase equiripple filter. Visualize the poles and zeros of the two filters.

```
hd2 = design(d,'equiripple','MinPhase',true);

hfvt = fvtool(hd1,hd2,'Analysis','polezero');
legend(hfvt,'Equiripple Filter','Minimum-phase Equiripple Filter')
```

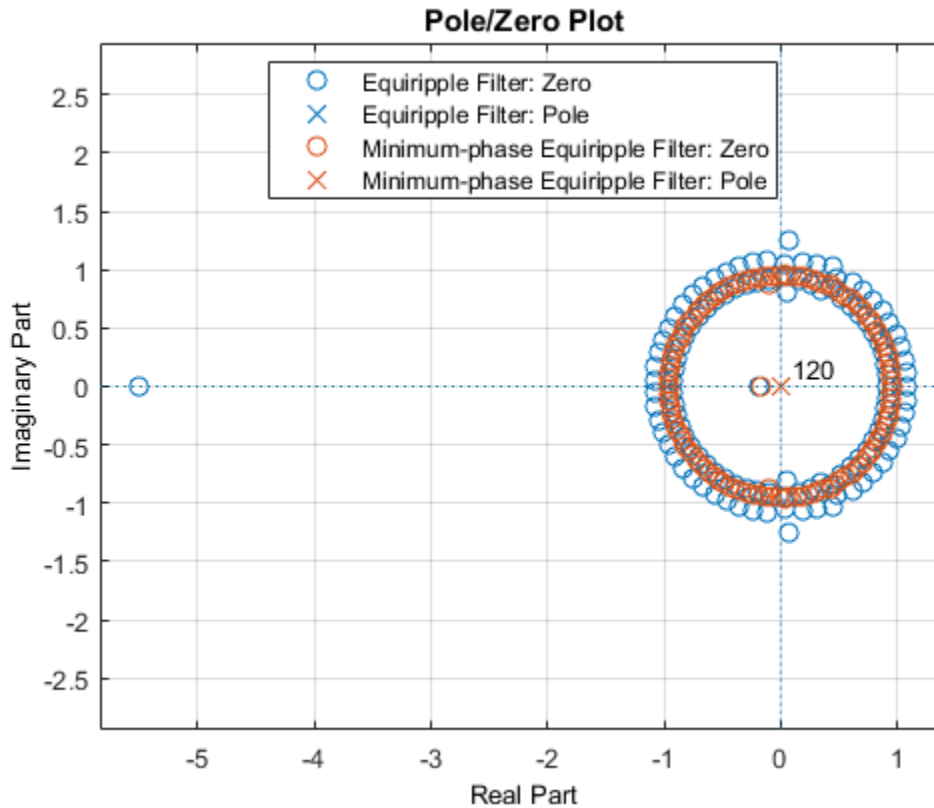

Design Multiband Minimum-Order Arbitrary-Magnitude Filter

Use `fdesign.arbmag` to design a multiband minimum order filter.

Place the notches at 0.25π and 0.55π rad/sample.

```
d = fdesign.arbmag('B,F,A,R');
d.NBands = 5;
d.B1Frequencies = [0 0.2];
d.B1Amplitudes = [1 1];
d.B1Ripple = 0.25;
d.B2Frequencies = 0.25;
d.B2Amplitudes = 0;
d.B3Frequencies = [0.3 0.5];
```



```
d.B3Amplitudes = [1 1];  
d.B3Ripple = 0.25;  
d.B4Frequencies = 0.55;  
d.B4Amplitudes = 0;  
d.B5Frequencies = [0.6 1];  
d.B5Amplitudes = [1 1];  
d.B5Ripple = 0.25;  
Hd = design(d, 'equiripple');
```

Visualize the frequency response of the resulting filter.

```
fvtool(Hd)
```

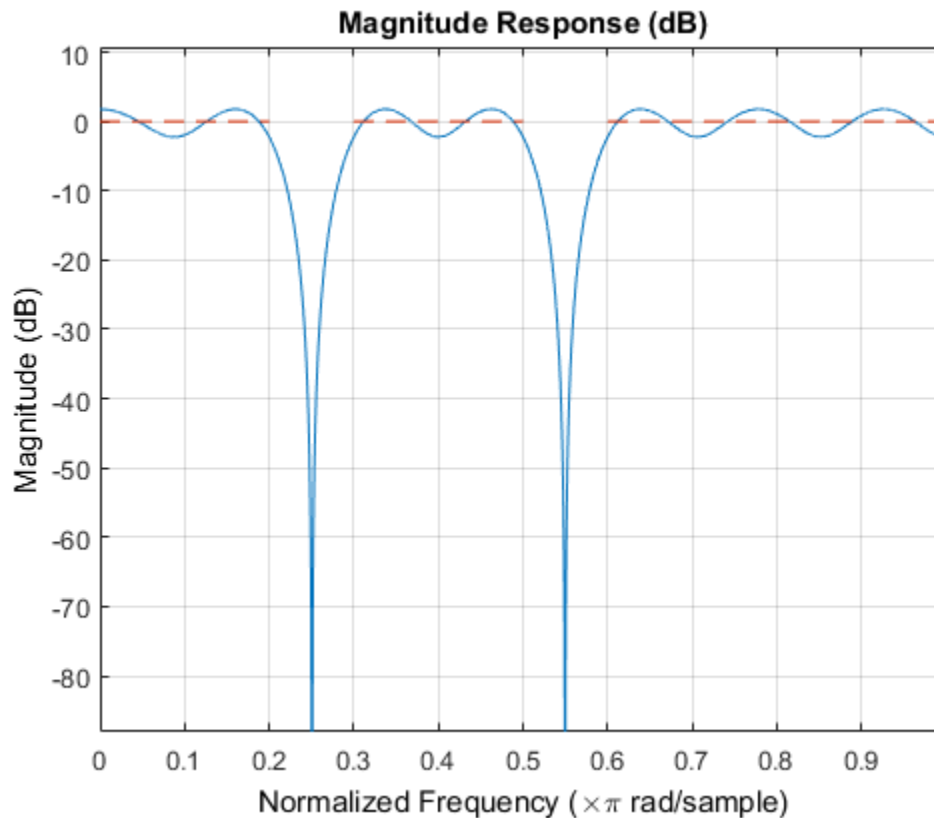

Design Multiband Constrained Arbitrary-Magnitude Filter

Use `fdesign.arbmag` to design a multiband constrained FIR filter.

Force the frequency response at 0.15π rad/sample to 0 dB.

```
d = fdesign.arbmag('N,B,F,A,C',82,2);
d.B1Frequencies = [0 0.06 0.1];
d.B1Amplitudes = [0 0 0];
d.B2Frequencies = [0.15 1];
d.B2Amplitudes = [1 1];
```

Design a filter with no constraints.

```
Hd1 = design(d,'equiripple','B2ForcedFrequencyPoints',0.15);
```

Add a constraint to the first band to increase attenuation.

```
d.B1Constrained = true;  
d.B1Ripple = 0.001;  
Hd2 = design(d, 'equiripple', 'B2ForcedFrequencyPoints', 0.15);
```

Visualize the frequency response.

```
hfvt = fvtool(Hd1, Hd2);  
legend(hfvt, 'Original Design', 'Design with Constrained Stopband Ripple')
```

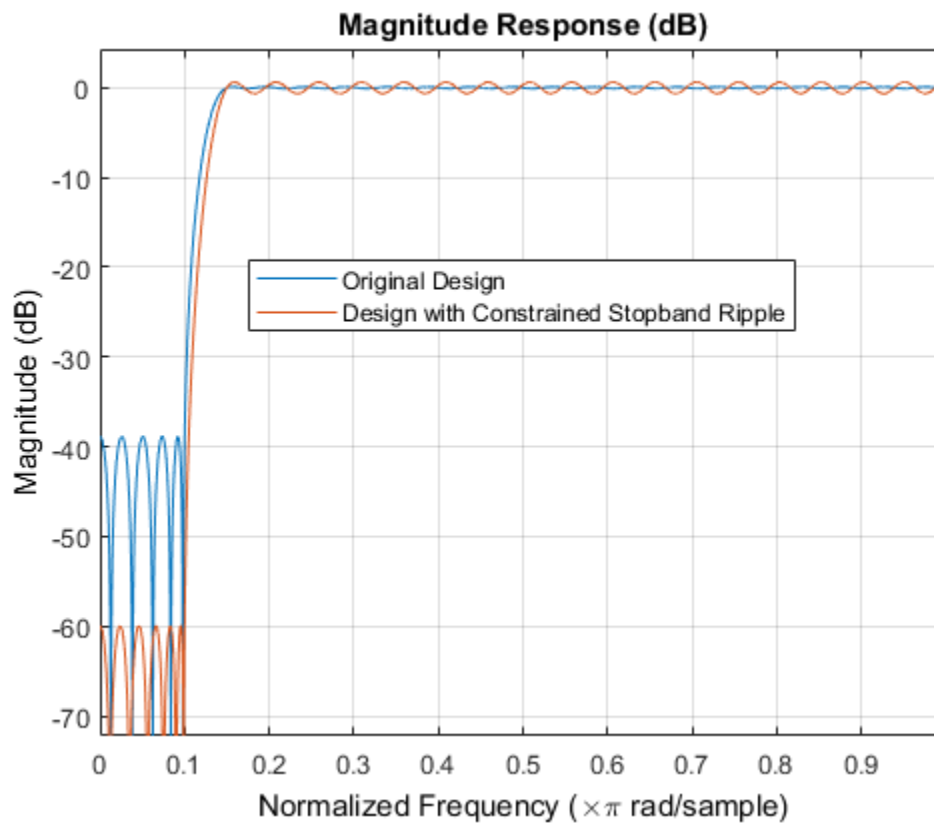

See Also

[design](#) | [designmethods](#) | [fdesign](#)

Introduced in R2009a

fdesign.bandpass

Bandpass filter specification object

Syntax

```
D = fdesign.bandpass
D = fdesign.bandpass(SPEC)
D = fdesign.bandpass(spec,specvalue1,specvalue2,...)
D = fdesign.bandpass(specvalue1,specvalue2,specvalue3,
specvalue4,...specvalue4,specvalue5,specvalue6)
D = fdesign.bandpass(...,Fs)
D = fdesign.bandpass(...,MAGUNITS)
```

Description

`D = fdesign.bandpass` constructs a bandpass filter specification object `D`, applying default values for the properties `Fstop1`, `Fpass1`, `Fpass2`, `Fstop2`, `Astop1`, `Apass`, and `Astop2` — one possible set of values you use to specify a bandpass filter.

`D = fdesign.bandpass(SPEC)` constructs object `D` and sets its `Specification` property to `SPEC`. Entries in the `SPEC` represent various filter response features, such as the filter order, that govern the filter design. Valid entries for `SPEC` are shown below and used to define the bandpass filter. These entries are not case sensitive.

Note: Specifications marked with an asterisk require the DSP System Toolbox software.

- 'Fst1,Fp1,Fp2,Fst2,Ast1,Ap,Ast2' (default spec)
- 'N,F3dB1,F3dB2'
- "N,F3dB1,F3dB2,Ap" *
- 'N,F3dB1,F3dB2,Ast' *
- 'N,F3dB1,F3dB2,Ast1,Ap,Ast2' *
- 'N,F3dB1,F3dB2,BWp' *

- 'N,F3dB1,F3dB2,BWst' *
- 'N,Fc1,Fc2'
- 'N,Fc1,Fc2,Ast1,Ap,Ast2'
- 'N,Fp1,Fp2,Ap'
- 'N,Fp1,Fp2,Ast1,Ap,Ast2'
- 'N,Fst1,Fp1,Fp2,Fst2'
- 'N,Fst1,Fp1,Fp2,Fst2,C' *
- 'N,Fst1,Fp1,Fp2,Fst2,Ap' *
- 'N,Fst1,Fst2,Ast'
- 'Nb,Na,Fst1,Fp1,Fp2,Fst2' *

The filter specifications are defined as follows:

- **Ap** — amount of ripple allowed in the pass band. Also called *Apass*.
- **Ast1** — attenuation in the first stop band in decibels (the default units). Also called *Astop1*.
- **Ast2** — attenuation in the second stop band in decibels (the default units). Also called *Astop2*.
- **BWp** — bandwidth of the filter passband. Specified in normalized frequency units.
- **BWst** — bandwidth of the filter stopband. Specified in normalized frequency units.
- **C** — Constrained band flag. This enables you to specify passband ripple or stopband attenuation for fixed-order designs in one or two of the three bands.

In the specification 'N,Fst1,Fp1,Fp2,Fst2,C', you cannot specify constraints in both stopbands and the passband simultaneously. You can specify constraints in any one or two bands.

- **F3dB1** — cutoff frequency for the point 3 dB point below the passband value for the first cutoff. Specified in normalized frequency units. (IIR filters)
- **F3dB2** — cutoff frequency for the point 3 dB point below the passband value for the second cutoff. Specified in normalized frequency units. (IIR filters)
- **Fc1** — cutoff frequency for the point 6 dB point below the passband value for the first cutoff. Specified in normalized frequency units. (FIR filters)
- **Fc2** — cutoff frequency for the point 6 dB point below the passband value for the second cutoff. Specified in normalized frequency units. (FIR filters)

- F_{p1} — frequency at the edge of the start of the pass band. Specified in normalized frequency units. Also called F_{pass1} .
- F_{p2} — frequency at the edge of the end of the pass band. Specified in normalized frequency units. Also called F_{pass2} .
- F_{st1} — frequency at the edge of the start of the first stop band. Specified in normalized frequency units. Also called F_{stop1} .
- F_{st2} — frequency at the edge of the start of the second stop band. Specified in normalized frequency units. Also called F_{stop2} .
- N — filter order for FIR filters. Or both the numerator and denominator orders for IIR filters when n_a and n_b are not provided.
- N_a — denominator order for IIR filters
- N_b — numerator order for IIR filters

Graphically, the filter specifications look similar to those shown in the following figure.

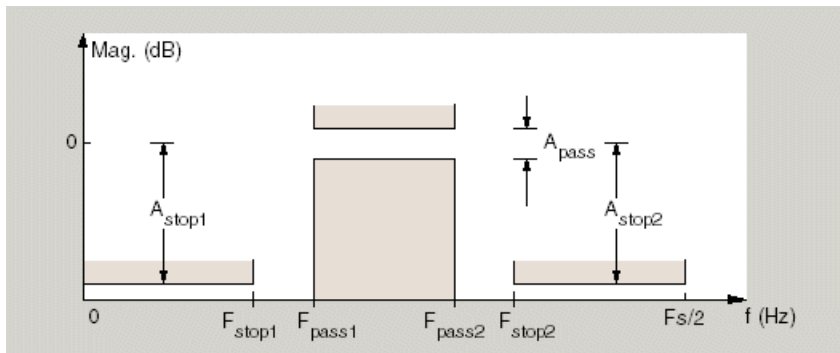

Regions between specification values like F_{st1} and F_{p1} are transition regions where the filter response is not explicitly defined.

The filter design methods that apply to a bandpass filter specification object change depending on the `Specification`. Use `designmethods` to determine which design methods apply to an object and the `Specification` property value.

Use `designopts` to determine the design options for a given design method. Enter `help(D, METHOD)` at the MATLAB command line to obtain detailed help on the design options for a given design method, `METHOD`.

`D = fdesign.bandpass(spec,specvalue1,specvalue2,...)` constructs an object `D` and sets its specifications at construction time.

`D = fdesign.bandpass(specvalue1,specvalue2,specvalue3,specvalue4,...specvalue4,specvalue5,specvalue6)` constructs `D` with the default `Specification` property, using the values you provide as input arguments for `specvalue1,specvalue2,specvalue3,specvalue4,specvalue4,specvalue5,specvalue6` and `specvalue7`.

`D = fdesign.bandpass(...,Fs)` adds the argument `Fs`, specified in Hz to define the sampling frequency to use. In this case, all frequencies in the specifications are in Hz as well.

`D = fdesign.bandpass(...,MAGUNITS)` specifies the units for any magnitude specification you provide in the input arguments. `MAGUNITS` can be one of

- `'linear'` — specify the magnitude in linear units
- `'dB'` — specify the magnitude in dB (decibels)
- `'squared'` — specify the magnitude in power units

When you omit the `MAGUNITS` argument, `fdesign` assumes that all magnitudes are in decibels. Note that `fdesign` stores all magnitude specifications in decibels (converting to decibels when necessary) regardless of how you specify the magnitudes.

Examples

Bandpass Filtering of Sinusoids

Filter a discrete-time signal with a bandpass filter. The signal is a sum of three discrete-time sinusoids, $\pi/8$, $\pi/2$, and $3\pi/4$ rad/sample.

```
n = 0:159;  
x = cos(pi/8*n)+cos(pi/2*n)+sin(3*pi/4*n);
```

Design an FIR equiripple bandpass filter to remove the lowest and highest discrete-time sinusoids. View the frequency response of the filter.

```
d = fdesign.bandpass('Fst1,Fp1,Fp2,Fst2,Ast1,Ap,Ast2', ...  
    1/4,3/8,5/8,6/8,60,1,60);
```



```
Hd = design(d,'equiripple');
```

```
freqz(Hd)
```

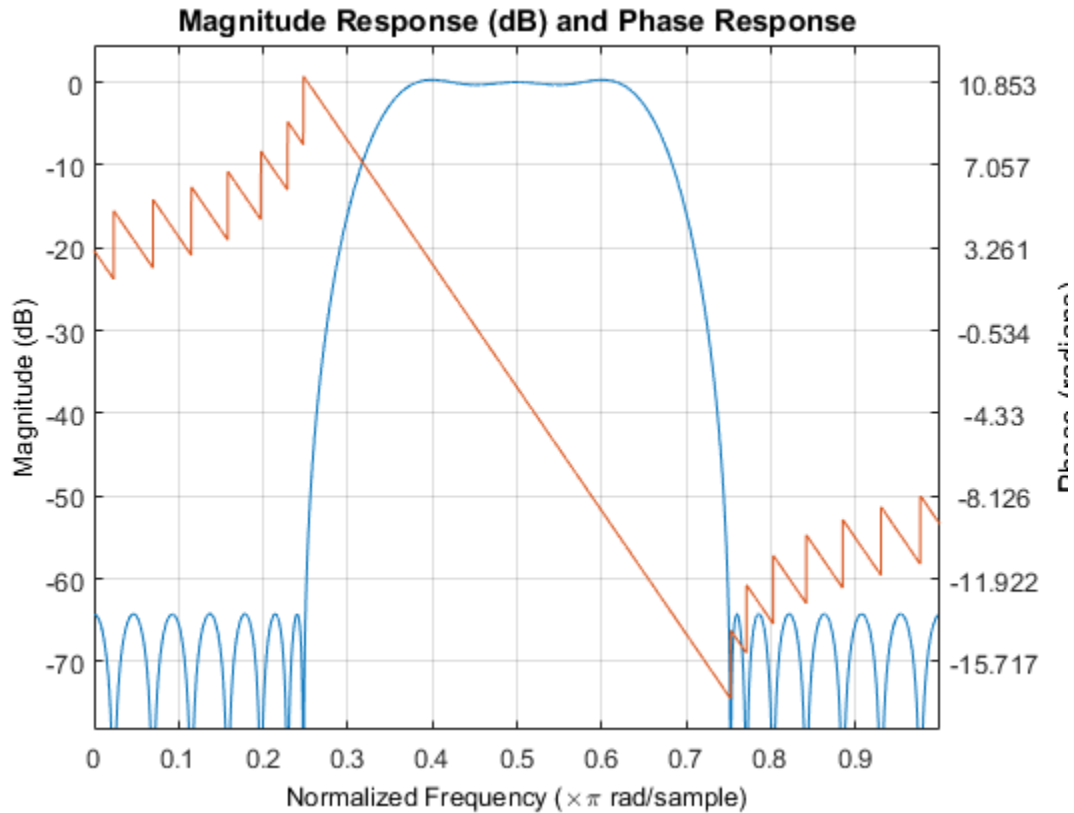

Apply the filter to the discrete-time signal. Plot the original and filtered signals in the frequency domain.

```
y = filter(Hd,x);
freq = 0:(2*pi)/length(x):pi;
xdft = fft(x);
ydft = fft(y);

plot(freq/pi,abs(xdft(1:length(x)/2+1)))
hold on
```

```
plot(freq/pi,abs(ydft(1:length(x)/2+1)))  
hold off  
xlabel('Normalized Frequency (\times\pi rad/sample)')  
legend('Original Signal','Bandpass Signal')
```

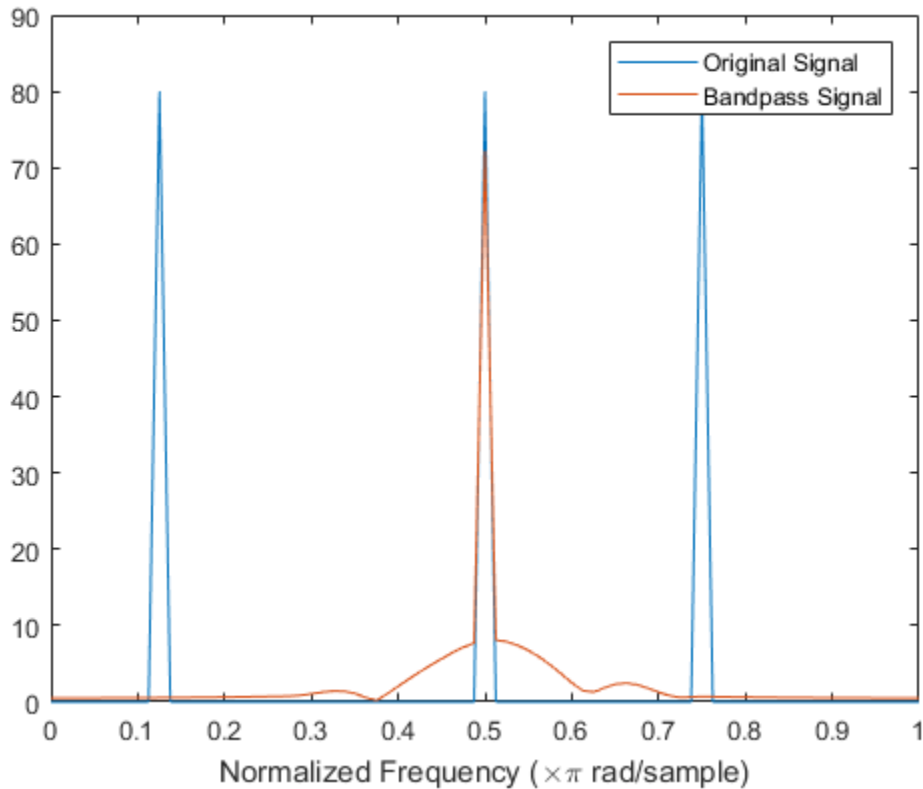

Butterworth Bandpass Filter

Design an IIR Butterworth filter of order 10 with 3-dB frequencies of 1 and 1.2 kHz. The sample rate is 10 kHz. Visualize the frequency response of the filter.

```
d = fdesign.bandpass('N,F3dB1,F3dB2',10,1e3,1.2e3,1e4);  
Hd = design(d,'butter');
```

```
fvtool(Hd)
```

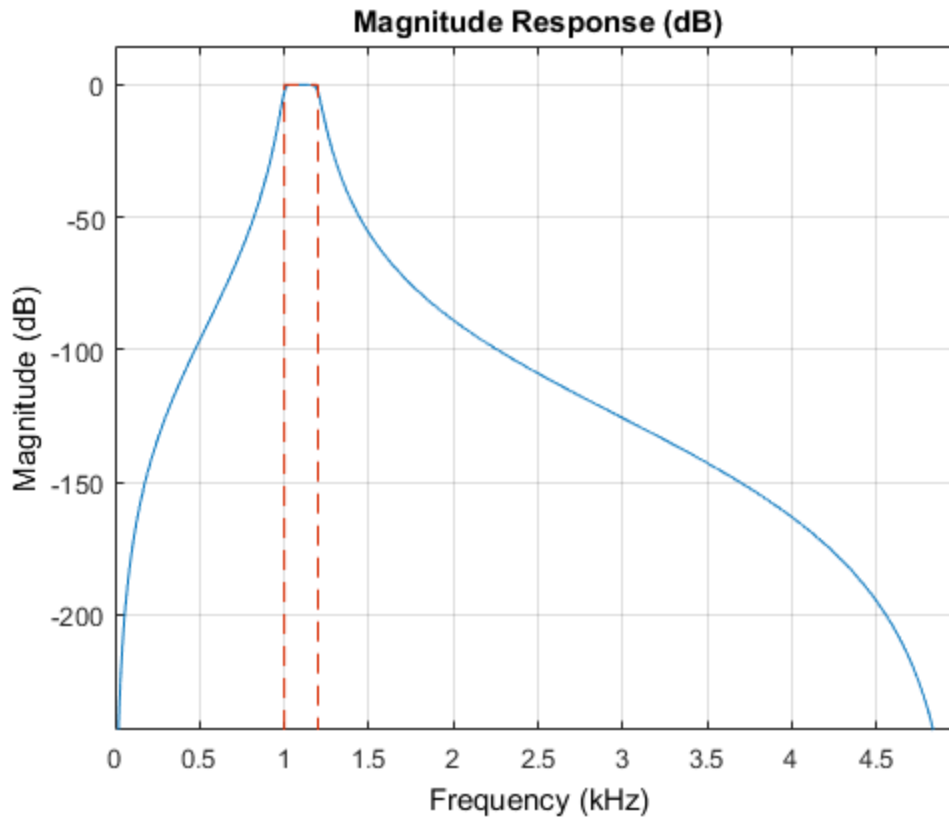

Equiripple FIR Passband Filter

Design a constrained-band FIR equiripple filter of order 100 with a passband of [1, 1.4] kHz. Both stopband attenuation values are constrained to 60 dB. The sample rate is 10 kHz.

```
d = fdesign.bandpass('N,Fst1,Fp1,Fp2,Fst2,C',100,800,1e3,1.4e3,1.6e3,1e4);  
d.Stopband1Constrained = true;  
d.Astop1 = 60;  
d.Stopband2Constrained = true;  
d.Astop2 = 60;
```

```
Hd = design(d, 'equiripple');
```

Visualize and measure the magnitude response of the filter.

```
fvtool(Hd)  
measure(Hd)
```

```
ans =
```

```
Sample Rate           : 10 kHz  
First Stopband Edge   : 800 Hz  
First 6-dB Point      : 946.7621 Hz  
First 3-dB Point      : 975.1807 Hz  
First Passband Edge   : 1 kHz  
Second Passband Edge  : 1.4 kHz  
Second 3-dB Point     : 1.4248 kHz  
Second 6-dB Point     : 1.4533 kHz  
Second Stopband Edge  : 1.6 kHz  
First Stopband Atten. : 60.0614 dB  
Passband Ripple       : 2.1443 dB  
Second Stopband Atten. : 60.0399 dB  
First Transition Width : 200 Hz  
Second Transition Width : 200 Hz
```

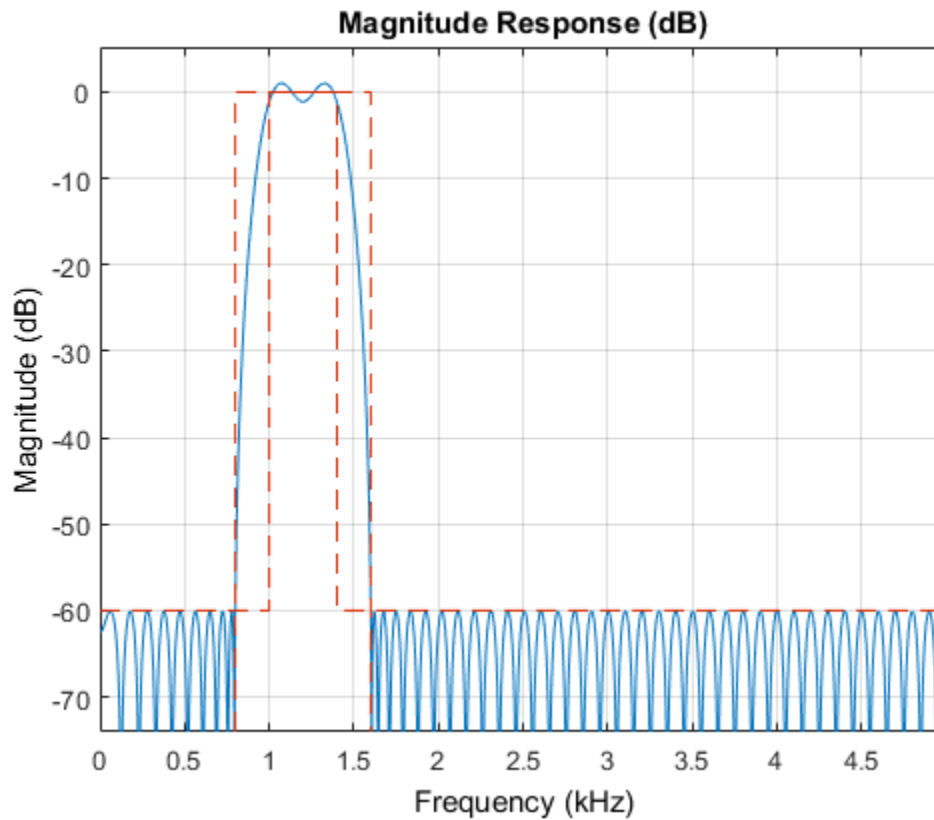

The passband ripple is slightly over 2 dB. Because the design constrains both stopbands, you cannot constrain the passband ripple.

See Also

See Also

fdesign | fdesign.bandstop | fdesign.highpass | fdesign.lowpass

Introduced in R2009a

fdesign.bandstop

Bandstop filter specification object

Syntax

```
D = fdesign.bandstop
D = fdesign.bandstop(SPEC)
D = fdesign.bandstop(SPEC,specvalue1,specvalue2,...)
D = fdesign.bandstop(specvalue1,specvalue2,specvalue3,specvalue4,...
specvalue5,specvalue6,specvalue7)
D = fdesign.bandstop(...,Fs)
D = fdesign.bandstop(...,MAGUNITS)
```

Description

`D = fdesign.bandstop` constructs a bandstop filter specification object `D`, applying default values for the properties `Fpass1`, `Fstop1`, `Fstop2`, `Fpass2`, `Apass1`, `Astop1` and `Apass2`.

`D = fdesign.bandstop(SPEC)` constructs object `D` and sets the `Specification` property to `SPEC`. Entries in `SPEC` represent various filter response features, such as the filter order, that govern the filter design. Valid entries for `SPEC` are shown below. These entries are not case sensitive.

Note: Specification options marked with an asterisk require the DSP System Toolbox software.

- 'Fp1,Fst1,Fst2,Fp2,Ap1,Ast,Ap2' (default spec)
- 'N,F3dB1,F3dB2'
- 'N,F3dB1,F3dB2,Ap' *
- 'N,F3dB1,F3dB2,Ap,Ast' *
- 'N,F3dB1,F3dB2,Ast' *

- 'N,F3dB1,F3dB2,BWp' *
- 'N,F3dB1,F3dB2,BWst' *
- 'N,Fc1,Fc2'
- 'N,Fc1,Fc2,Ap1,Ast,Ap2'
- 'N,Fp1,Fp2,Ap'
- 'N,Fp1,Fp2,Ap,Ast'
- 'N,Fp1,Fst1,Fst2,Fp2'
- 'N,Fp1,Fst1,Fst2,Fp2,C' *
- 'N,Fp1,Fst1,Fst2,Fp2,Ap' *
- 'N,Fst1,Fst2,Ast'
- 'Nb,Na,Fp1,Fst1,Fst2,Fp2' *

The filter specifications are defined as follows:

- **Ap** — amount of ripple allowed in the passband in decibels (the default units). Also called **Apass**.
- **Ap1** — amount of ripple allowed in the pass band in decibels (the default units). Also called **Apass1**.
- **Ap2** — amount of ripple allowed in the pass band in decibels (the default units). Also called **Apass2**.
- **Ast** — attenuation in the first stopband in decibels (the default units). Also called **Astop1**.
- **BWp** — bandwidth of the filter passband. Specified in normalized frequency units.
- **BWst** — bandwidth of the filter stopband. Specified in normalized frequency units.
- **C** — Constrained band flag. This enables you to specify passband ripple or stopband attenuation for fixed-order designs in one or two of the three bands.

In the specification 'N,Fp1,Fst1,Fst2,Fp2,C', you cannot specify constraints simultaneously in both passbands and the stopband. You can specify constraints in any one or two bands.

- **F3dB1** — cutoff frequency for the point 3 dB point below the passband value for the first cutoff.
- **F3dB2** — cutoff frequency for the point 3 dB point below the passband value for the second cutoff.

- F_{c1} — cutoff frequency for the point 6 dB point below the passband value for the first cutoff. (FIR filters)
- F_{c2} — cutoff frequency for the point 6 dB point below the passband value for the second cutoff. (FIR filters)
- F_{p1} — frequency at the start of the pass band. Also called F_{pass1} .
- F_{p2} — frequency at the end of the pass band. Also called F_{pass2} .
- F_{st1} — frequency at the end of the first stop band. Also called F_{stop1} .
- F_{st2} — frequency at the end of the second stop band. Also called F_{stop2} .
- N — filter order.
- N_a — denominator order for IIR filters.
- N_b — numerator order for IIR filters.

Graphically, the filter specifications look similar to those shown in the following figure.

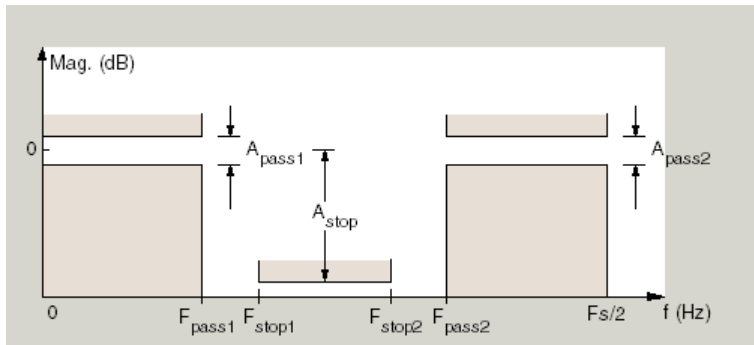

Regions between specification values like F_{p1} and F_{st1} are transition regions where the filter response is not explicitly defined.

The filter design methods that apply to a bandstop filter specification object change depending on the `Specification`. Use `designmethods` to determine which design methods apply to an object and the `Specification` property value.

Use `designopts` to determine the design options for a given design method. Enter `help(D, METHOD)` at the MATLAB command line to obtain detailed help on the design options for a given design method, `METHOD`.

`D = fdesign.bandstop(SPEC,specvalue1,specvalue2,...)` constructs an object `D` and sets its specifications at construction time.

`D = fdesign.bandstop(specvalue1,specvalue2,specvalue3,specvalue4,...,specvalue5,specvalue6,specvalue7)` constructs an object `D` with the default `Specification` property, using the values you provide in `specvalue1,specvalue2,specvalue3,specvalue4,specvalue5,specvalue6` and `specvalue7`.

`D = fdesign.bandstop(...,Fs)` adds the argument `Fs`, specified in Hz to define the sampling frequency. If you specify the sampling frequency as a trailing scalar, all frequencies in the specifications are in Hz as well.

`D = fdesign.bandstop(...,MAGUNITS)` specifies the units for any magnitude specification you provide in the input arguments. `MAGUNITS` can be one of

- `'linear'` — specify the magnitude in linear units
- `'dB'` — specify the magnitude in dB (decibels)
- `'squared'` — specify the magnitude in power units

When you omit the `MAGUNITS` argument, `fdesign` assumes that all magnitudes are in decibels. Note that `fdesign` stores all magnitude specifications in decibels (converting to decibels when necessary) regardless of how you specify the magnitudes.

Examples

Bandstop Filtering of Sinusoids

Construct a bandstop filter to reject the discrete frequency band between $3\pi/8$ and $5\pi/8$ rad/sample. Apply the filter to a discrete-time signal consisting of the superposition of three discrete-time sinusoids.

Design an FIR equiripple filter and view its magnitude response.

```
d = fdesign.bandstop('Fp1,Fst1,Fst2,Fp2,Ap1,Ast,Ap2', ...
    2/8,3/8,5/8,6/8,1,60,1);
Hd = design(d,'equiripple');

fvtool(Hd)
```

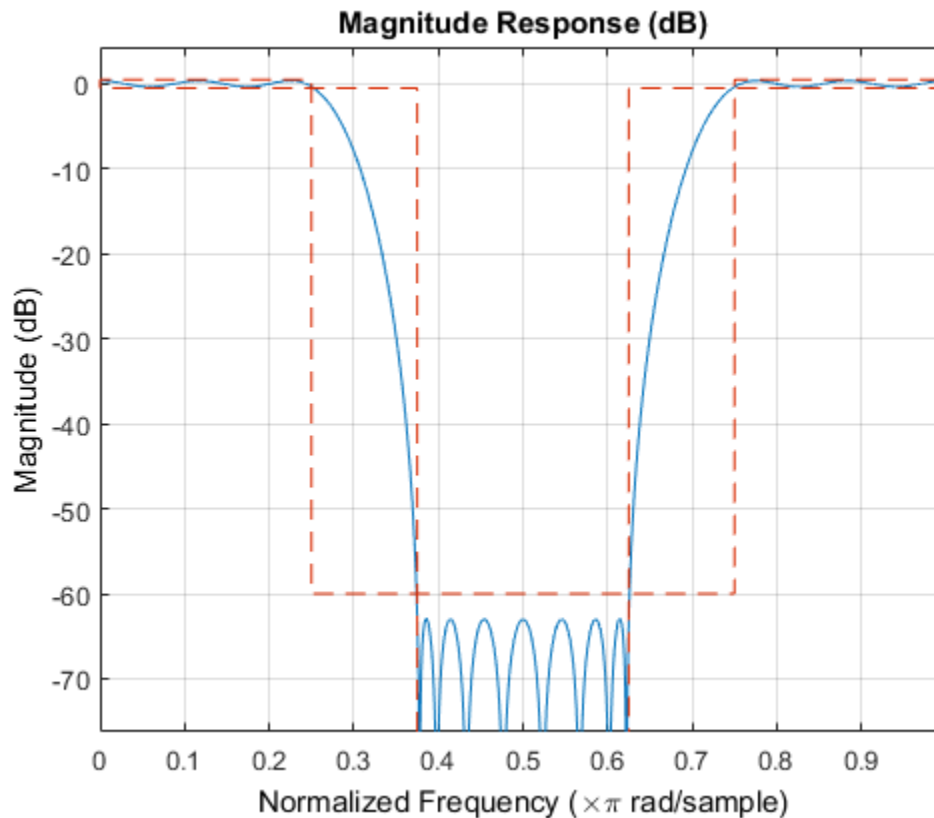

Construct the discrete-time signal and filter it.

```
n = 0:99;
x = cos(pi/5*n)+sin(pi/2*n)+cos(4*pi/5*n);
y = filter(Hd,x);
```

Plot the original and filtered signals in the frequency domain.

```
xdft = fft(x);
ydft = fft(y);
freq = 0:(2*pi)/length(x):pi;

plot(freq/pi,abs(xdft(1:length(x)/2+1)))
hold on
```

```

plot(freq/pi,abs(ydft(1:length(y)/2+1)),'r','linewidth',2)
hold off
xlabel('\times\pi rad/sample')
ylabel('Magnitude')
legend('Original Signal','Bandstop Signal')

```

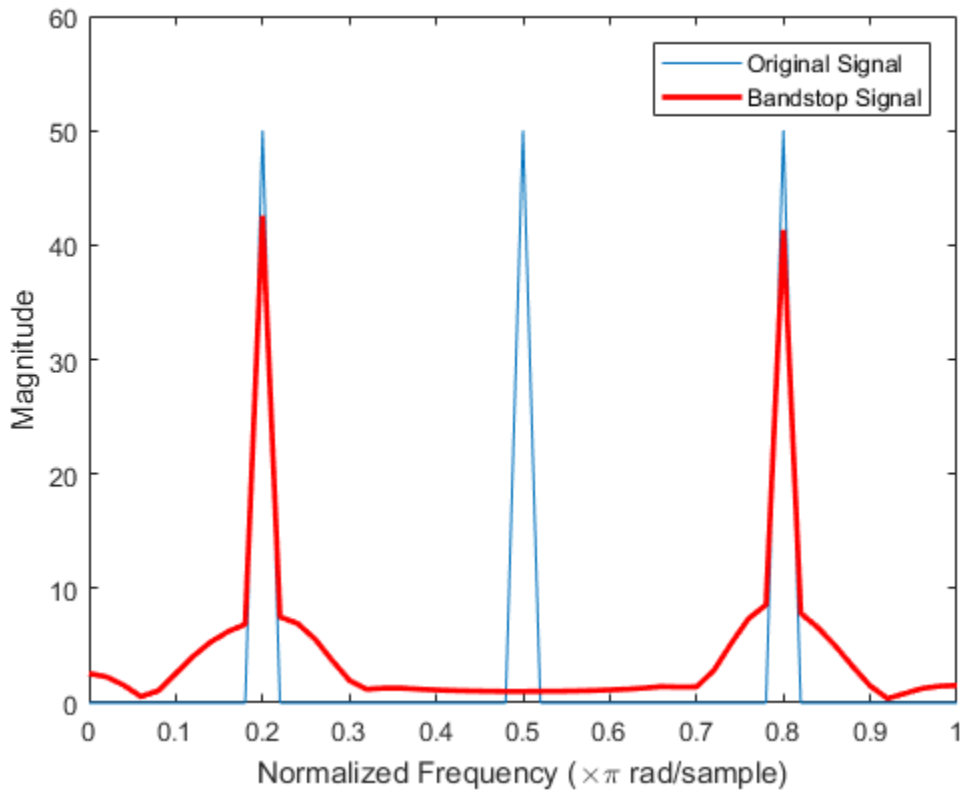

Butterworth Bandstop Filter

Create a Butterworth bandstop filter for data sampled at 10 kHz. The stopband is [1,1.5] kHz. The order of the filter is 20. Visualize the frequency response.

```

d = fdesign.bandstop('N,F3dB1,F3dB2',20,1e3,1.5e3,1e4);
Hd = design(d,'butter');

```

```
fvtool(Hd)
```

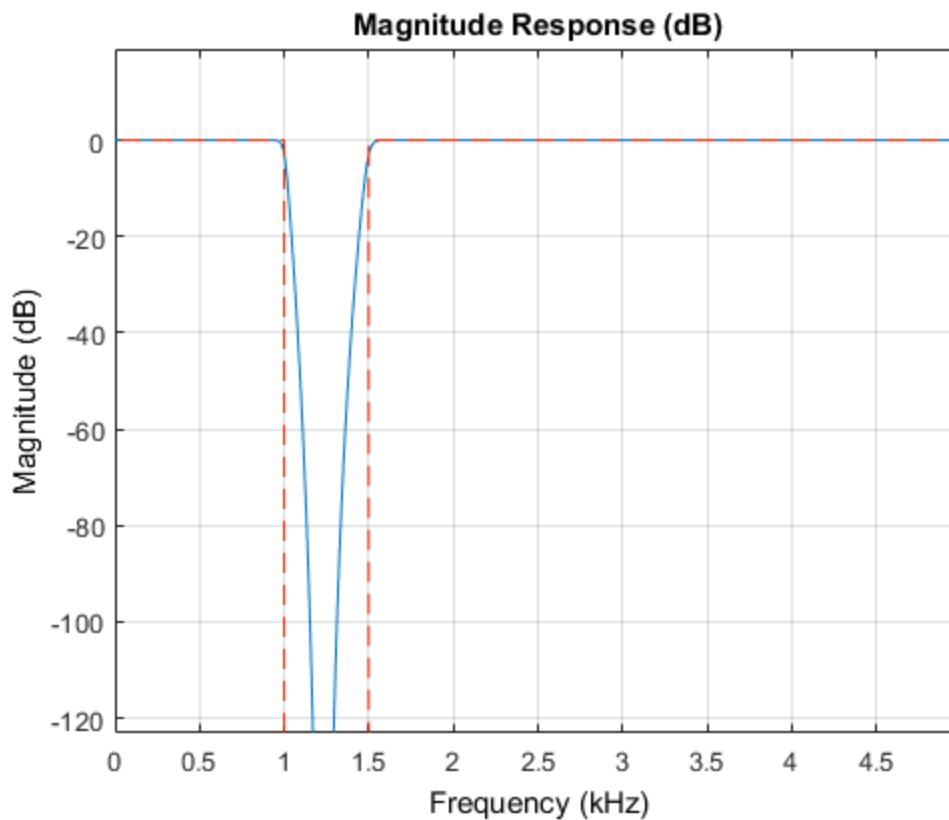

Zoom in on the magnitude response plot to verify that the 3-dB down points are located at 1 and 1.5 kHz.

```
axis([0.5 2 -5 2])
```

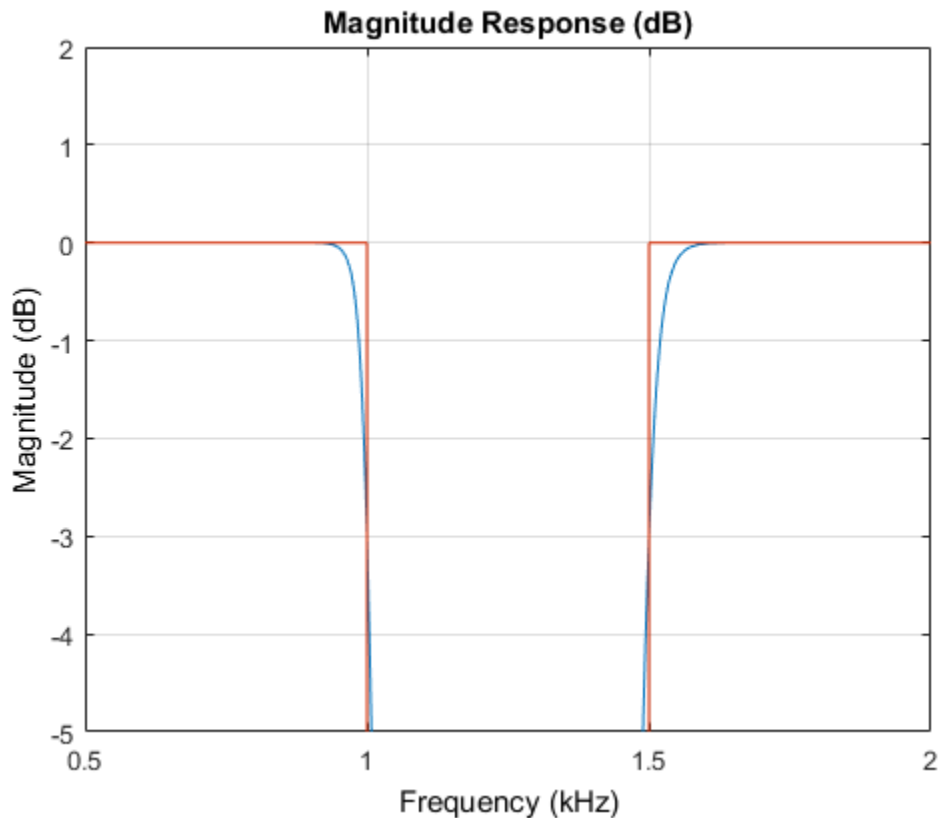

Equiripple FIR Bandstop Filter

Design a constrained-band FIR equiripple filter of order 100 for data sampled at 10 kHz. You can specify constraints on at most two of the three bands: two passbands and one stopband. In this example, constrain the passband ripple to be 0.5 dB in each passband.

```
d = fdesign.bandstop('N,Fp1,Fst1,Fst2,Fp2,C',100,800,1e3,1.5e3,1.7e3,1e4);
d.Passband1Constrained = true; d.Apass1 = 0.5;
d.Passband2Constrained = true; d.Apass2 = 0.5;
Hd = design(d,'equiripple');
```

Visualize the magnitude response and measure the design.

```
fvtool(Hd)
```

measure(Hd)

ans =

Sample Rate	: 10 kHz
First Passband Edge	: 800 Hz
First 3-dB Point	: 852.4565 Hz
First 6-dB Point	: 881.7834 Hz
First Stopband Edge	: 1 kHz
Second Stopband Edge	: 1.5 kHz
Second 6-dB Point	: 1.6185 kHz
Second 3-dB Point	: 1.6478 kHz
Second Passband Edge	: 1.7 kHz
First Passband Ripple	: 0.49642 dB
Stopband Atten.	: 48.8466 dB
Second Passband Ripple	: 0.49634 dB
First Transition Width	: 200 Hz
Second Transition Width	: 200 Hz

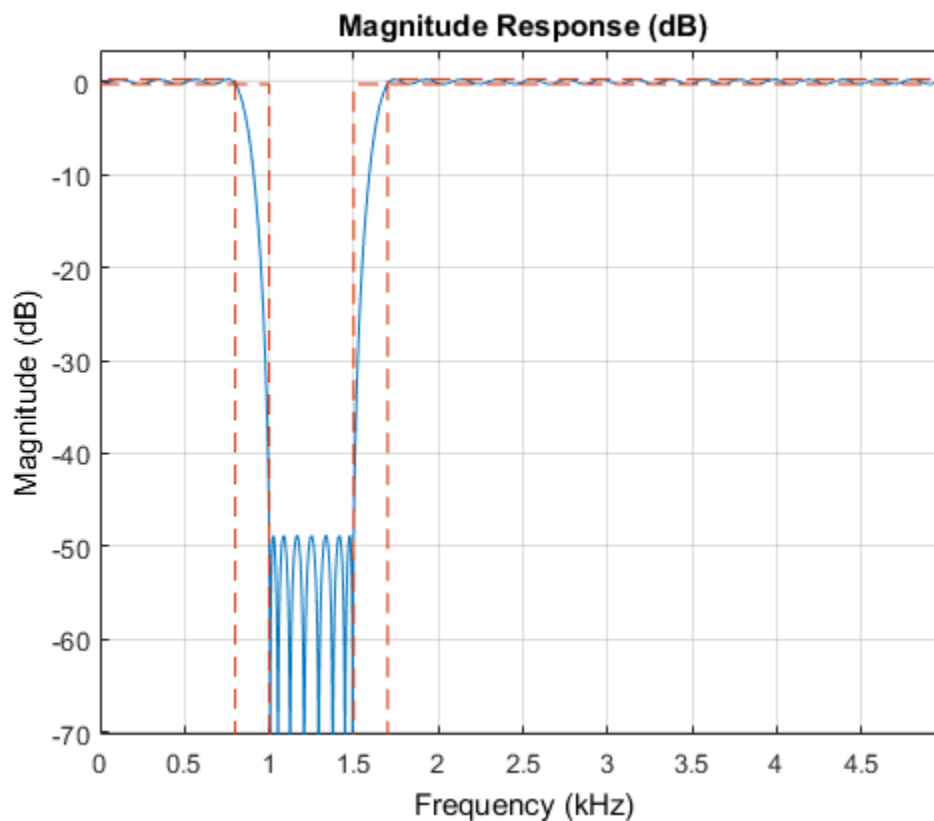

With this order filter and passband ripple constraints, you achieve approximately 50 dB of stopband attenuation.

See Also

See Also

fdesign | fdesign.bandpass | fdesign.highpass | fdesign.lowpass

Introduced in R2009a

fdesign.differentiator

Differentiator filter specification object

Syntax

```
D = fdesign.differentiator
D = fdesign.differentiator(SPEC)
D = fdesign.differentiator(SPEC,specvalue1,specvalue2, ...)
D = fdesign.differentiator(specvalue1)
D = fdesign.differentiator(...,Fs)
D = fdesign.differentiator(...,MAGUNITS)
```

Description

`D = fdesign.differentiator` constructs a default differentiator filter designer `D` with the filter order set to 31.

`D = fdesign.differentiator(SPEC)` initializes the filter designer `Specification` property to `SPEC`. You provide one of the following filter entries as input to replace `SPEC`. These entries are not case sensitive.

- 'N' — Full band differentiator (default)
- 'N,Fp,Fst' — Partial band differentiator

The filter specifications are defined as follows:

- `Ap` — amount of ripple allowed in the pass band in decibels (the default units). Also called `Apass`.
- `Ast` — attenuation in the stop band in decibels (the default units). Also called `Astop`.
- `Fp` — frequency at the start of the pass band. Specified in normalized frequency units. Also called `Fpass`.
- `Fst` — frequency at the end of the stop band. Specified in normalized frequency units. Also called `Fstop`.
- `N` — filter order.

By default, `fdesign.differentiator` assumes that all frequency specifications are provided in normalized frequency units. Also, decibels is the default for all magnitude specifications.

Use `designopts` to determine the design options for a given design method. Enter `help(D,METHOD)` at the MATLAB command line to obtain detailed help on the design options for a given design method, `METHOD`.

`D = fdesign.differentiator(SPEC,specvalue1,specvalue2, ...)` initializes the filter designer specifications in `SPEC` with `specvalue1`, `specvalue2`, and so on. To get a description of the specifications `specvalue1`, `specvalue2`, and more, enter

```
get(d, 'description')
```

at the Command prompt.

`D = fdesign.differentiator(specvalue1)` assumes the default specification `N`, setting the filter order to the value you provide.

`D = fdesign.differentiator(...,Fs)` adds the argument `Fs`, specified in Hz to define the sampling frequency to use. In this case, all frequencies in the specifications are in Hz as well.

`D = fdesign.differentiator(...,MAGUNITS)` specifies the units for any magnitude specification you provide in the input arguments. `MAGUNITS` can be one of

- 'linear' — specify the magnitude in linear units
- 'dB' — specify the magnitude in dB (decibels)
- 'squared' — specify the magnitude in power units

When you omit the `MAGUNITS` argument, `fdesign` assumes that all magnitudes are in decibels. Note that `fdesign` stores all magnitude specifications in decibels (converting to decibels when necessary) regardless of how you specify the magnitudes.

Examples

FM to AM by Differentiation

Use an FIR equiripple differentiator to transform frequency modulation into amplitude modulation, which can be detected using an envelope detector.

Modulate a message signal consisting of a 20 Hz sine wave with a 1 kHz carrier frequency. The sample rate is 10 kHz.

```
t = linspace(0,1,1e4);  
x = cos(2*pi*20*t);  
Fc = 1e3;  
Fs = 1e4;  
y = modulate(x,Fc,Fs,'fm');
```

Design the equiripple FIR differentiator of order 31.

```
d = fdesign.differentiator(31,Fs);  
Hd = design(d,'equiripple');
```

Filter the modulated signal and use the `hilbert` function to obtain the envelope. Plot the envelope.

```
y1 = filter(Hd,y);  
yh = hilbert(y1);  
  
plot(t.*1000,abs(yh));  
grid  
  
xlabel('Milliseconds')  
ylabel('Magnitude')  
title('Envelope of the Demodulated Signal')
```

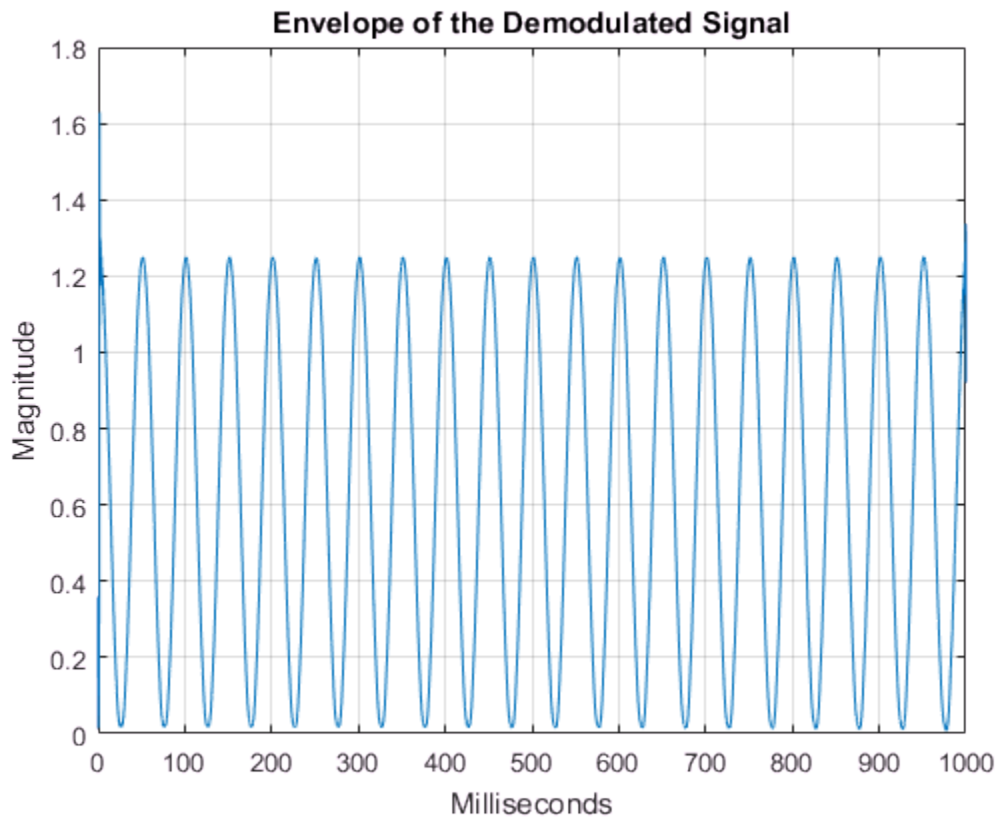

The envelope completes two cycles every 100 milliseconds. The envelope is oscillating at 20 Hz, which is the frequency of the message signal.

FIR Differentiator Filters

Design a 33rd-order FIR differentiator using least squares. Plot the zero-phase response of the filter.

```
d = fdesign.differentiator(33);  
hd = design(d, 'firls');  
  
zerophase(hd)
```

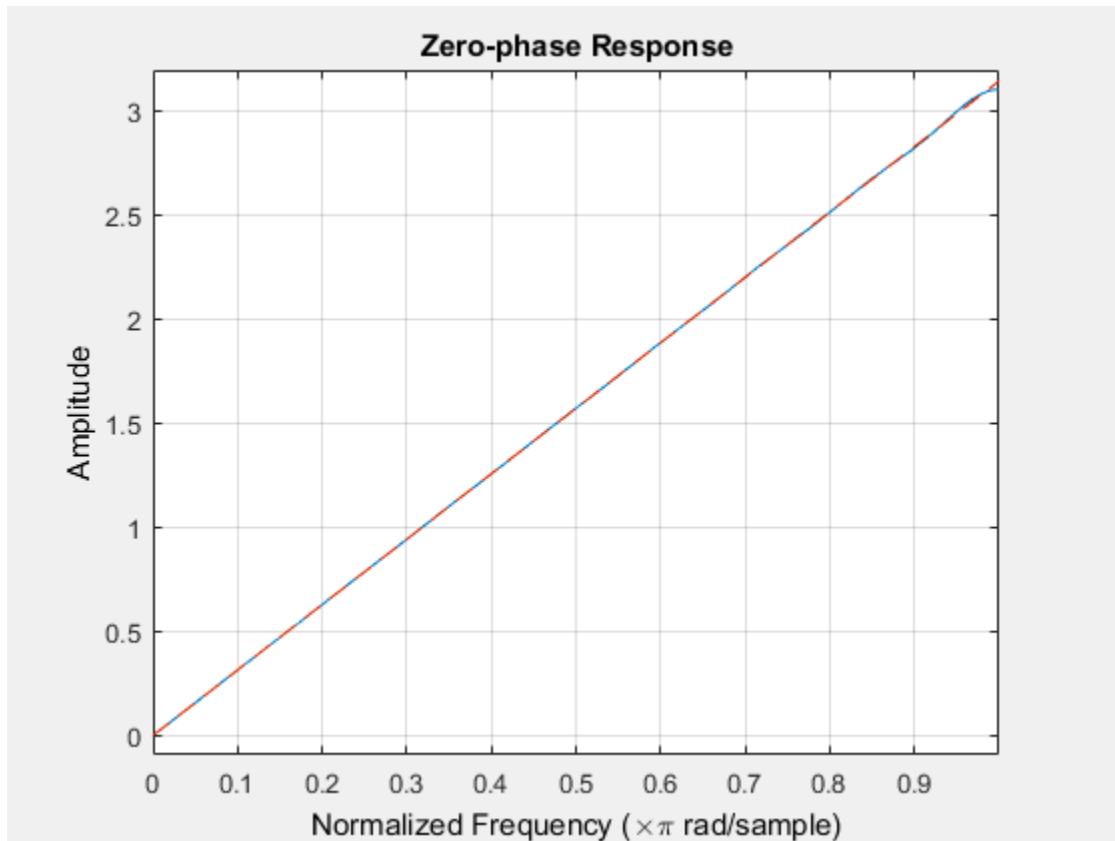

Design a 54th-order narrowband equiripple differentiator. Differentiate the lowest 25% of the frequencies in the Nyquist range and filter the higher frequencies. Specify a sample rate of 20 kHz, a passband frequency of 2.5 kHz, and a stopband frequency of 3 kHz.

```
Fs = 20000;
```

```
d = fdesign.differentiator('N,Fp,Fst',54,2500,3000,Fs);  
Hd = design(d,'equiripple');
```

Redesign the filter, but this time weight the stopband to increase the attenuation.

```
Hd1 = design(d,'equiripple','Wstop',4);
```

```
hfvt = fvtool(Hd,Hd1,'MagnitudeDisplay','zero-phase', ...  
    'FrequencyRange',[0, Fs/2]);  
legend(hfvt,'No stopband weighting','Stopband weighting');
```

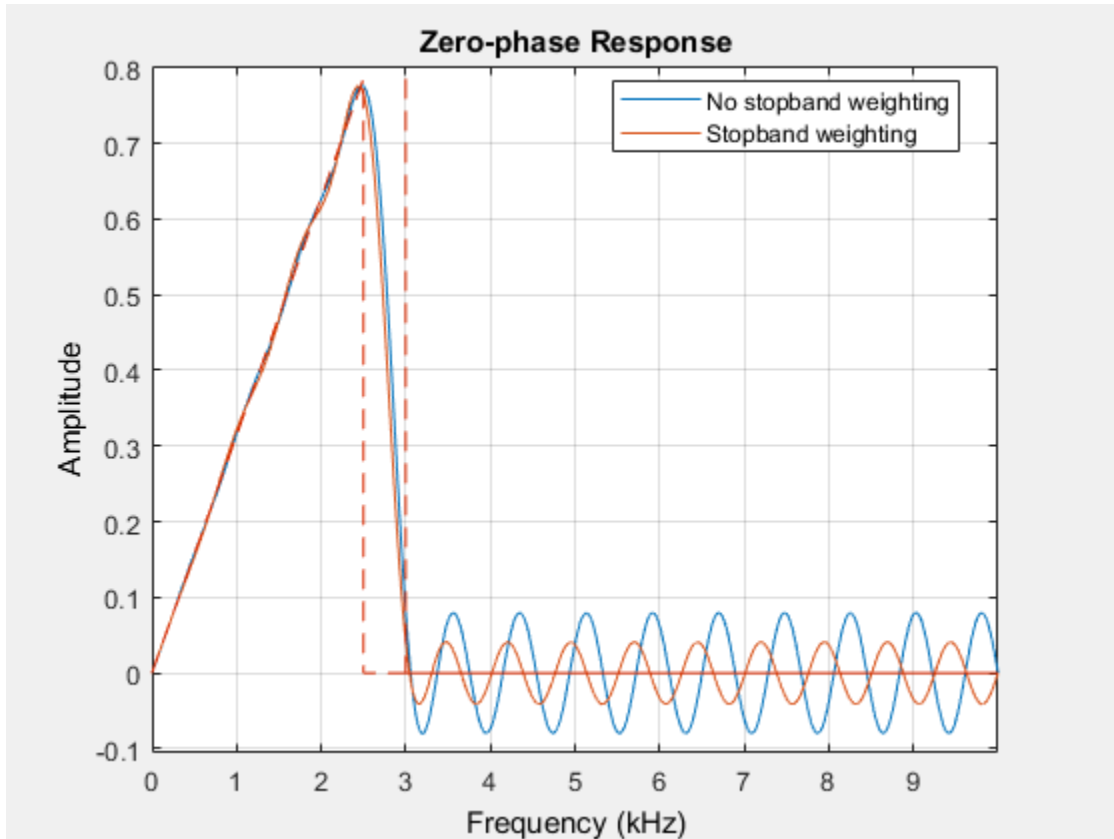

See Also

See Also

design | fdesign

Introduced in R2009a

fdesign.highpass

Highpass filter specification object

Syntax

```
D = fdesign.highpass
D = fdesign.highpass(SPEC)
D = fdesign.highpass(SPEC,specvalue1,specvalue2,...)
D = fdesign.highpass(specvalue1,specvalue2,specvalue3,
specvalue4)
D = fdesign.highpass(...,Fs)
D = fdesign.highpass(...,MAGUNITS)
```

Description

`D = fdesign.highpass` constructs a highpass filter specification object `D`, applying default values for the specification, `'Fst,Fp,Ast,Ap'`.

`D = fdesign.highpass(SPEC)` constructs object `D` and sets the `Specification` property to `SPEC`. Entries in the `SPEC` represent various filter response features, such as the filter order, that govern the filter design. Valid entries for `SPEC` are shown below. These entries are not case sensitive.

Note: Specification entries marked with an asterisk require the DSP System Toolbox software.

- `'Fst,Fp,Ast,Ap'` (default spec)
- `'N,F3db'`
- `'N,F3db,Ap' *`
- `'N,F3db,Ast' *`
- `'N,F3db,Ast,Ap' *`
- `'N,F3db,Fp' *`

- 'N, Fc'
- 'N, Fc, Ast, Ap'
- 'N, Fp, Ap'
- 'N, Fp, Ast, Ap'
- 'N, Fst, Ast'
- 'N, Fst, Ast, Ap'
- 'N, Fst, F3db' *
- 'N, Fst, Fp'
- 'N, Fst, Fp, Ap' *
- 'N, Fst, Fp, Ast' *
- 'Nb, Na, Fst, Fp' *

The filter specifications are defined as follows:

- **Ap** — amount of ripple allowed in the pass band in decibels (the default units). Also called **Apass**.
- **Ast** — attenuation in the stop band in decibels (the default units). Also called **Astop**.
- **F3db** — cutoff frequency for the point 3 dB below the passband value. Specified in normalized frequency units.
- **Fc** — cutoff frequency for the point 6 dB below the passband value. Specified in normalized frequency units.
- **Fp** — frequency at the start of the pass band. Specified in normalized frequency units. Also called **Fpass**.
- **Fst** — frequency at the end of the stop band. Specified in normalized frequency units. Also called **Fstop**.
- **N** — filter order.
- **Na** and **Nb** are the order of the denominator and numerator.

Graphically, the filter specifications look similar to those shown in the following figure.

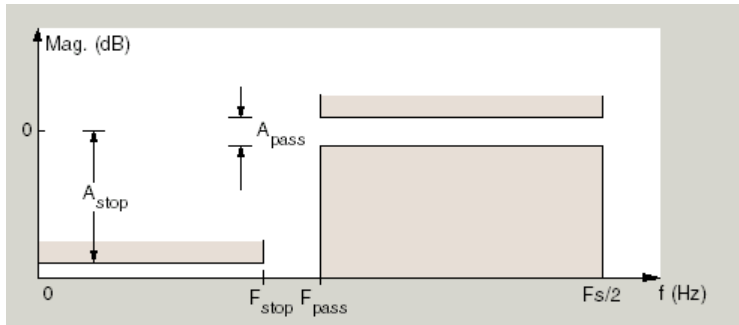

Regions between specification values like F_{st} and F_p are transition regions where the filter response is not explicitly defined.

The filter design methods that apply to a highpass filter specification object change depending on the **Specification**. Use `designmethods` to determine which design method applies to an object and its specification.

Use `designopts` to determine which design options are valid for a given design method. For detailed information on design options for a given design method, `METHOD`, enter `help(D,METHOD)` at the MATLAB command line.

`D = fdesign.highpass(SPEC,specvalue1,specvalue2,...)` constructs an object `D` and sets its specification values at construction time.

`D = fdesign.highpass(specvalue1,specvalue2,specvalue3,specvalue4)` constructs an object `D` with the default **Specification** property and the values you enter for `specvalue1,specvalue2,...`.

`D = fdesign.highpass(...,Fs)` provides the sampling frequency for the filter specification object. `Fs` is in Hz and must be specified as a scalar trailing the other numerical values provided. If you specify a sampling frequency, all other frequency specifications are in Hz.

`D = fdesign.highpass(...,MAGUNITS)` specifies the units for any magnitude specification you provide in the input arguments. `MAGUNITS` can be one of

- 'linear' — specify the magnitude in linear units
- 'dB' — specify the magnitude in dB (decibels)
- 'squared' — specify the magnitude in power units

When you omit the `MAGUNITS` argument, `fdesign` assumes that all magnitudes are in decibels. Note that `fdesign` stores all magnitude specifications in decibels (converting to decibels when necessary) regardless of how you specify the magnitudes.

Examples

Highpass Filtering of Sinusoids

Highpass filter a discrete-time signal consisting of two sine waves.

Create a highpass filter specification object. Specify the passband frequency to be 0.25π rad/sample and the stopband frequency to be 0.15π rad/sample. Specify 1 dB of allowable passband ripple and a stopband attenuation of 60 dB.

```
d = fdesign.highpass('Fst,Fp,Ast,Ap',0.15,0.25,60,1);
```

Query the valid design methods for your filter specification object.

```
designmethods(d)
```

```
Design Methods for class fdesign.highpass (Fst,Fp,Ast,Ap):
```

```
butter  
cheby1  
cheby2  
ellip  
equiripple  
ifir  
kaiserwin
```

Create an FIR equiripple filter and view the filter magnitude response with `FVTool`.

```
Hd = design(d,'equiripple');  
fvtool(Hd)
```

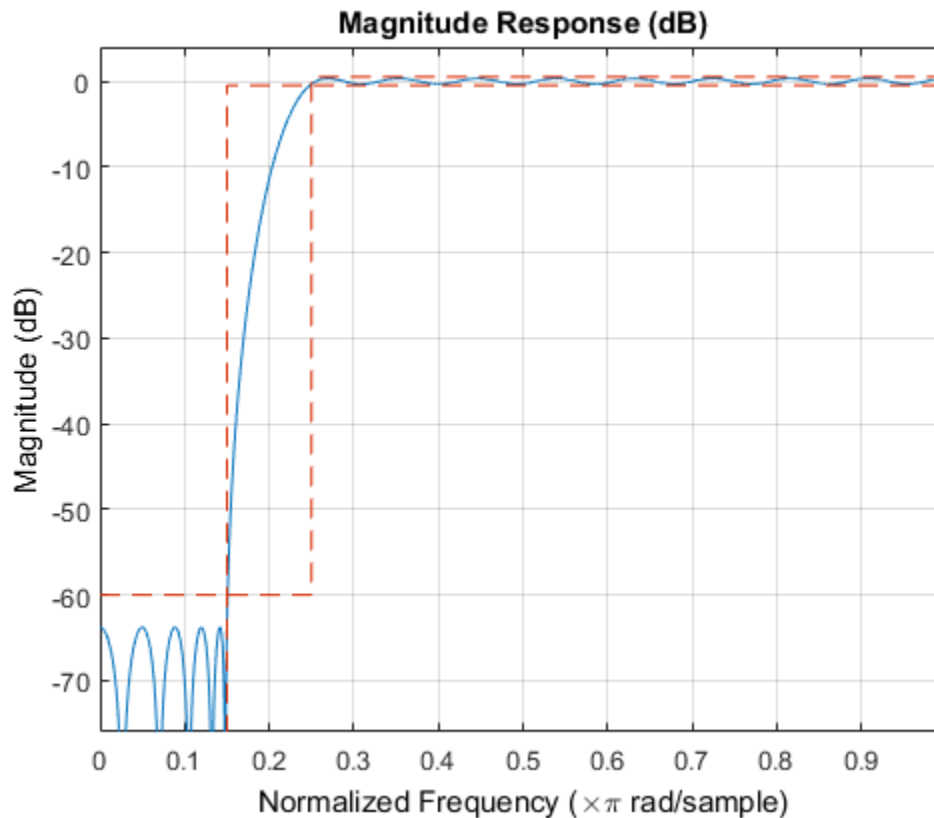

Create a signal consisting of the sum of two discrete-time sinusoids with frequencies of $\pi/8$ and $\pi/4$ rad/sample and amplitudes of 1 and 0.25 respectively. Filter the discrete-time signal with the FIR equiripple filter object.

```
n = 0:159;
x = cos(pi/8*n)+0.25*sin(pi/4*n);
y = filter(Hd,x);
```

Plot the original and filtered signals in the frequency domain.

```
freq = 0:(2*pi)/160:pi;
xdft = fft(x);
ydft = fft(y);
```

```

plot(freq/pi,abs(xdft(1:length(x)/2+1)))
hold on
plot(freq/pi,abs(ydft(1:length(y)/2+1)),'r','linewidth',2)
hold off
legend('Original Signal','Lowpass Signal','Location','NorthEast')
ylabel('Magnitude')
xlabel('Normalized Frequency (\times\pi rad/sample)')

```

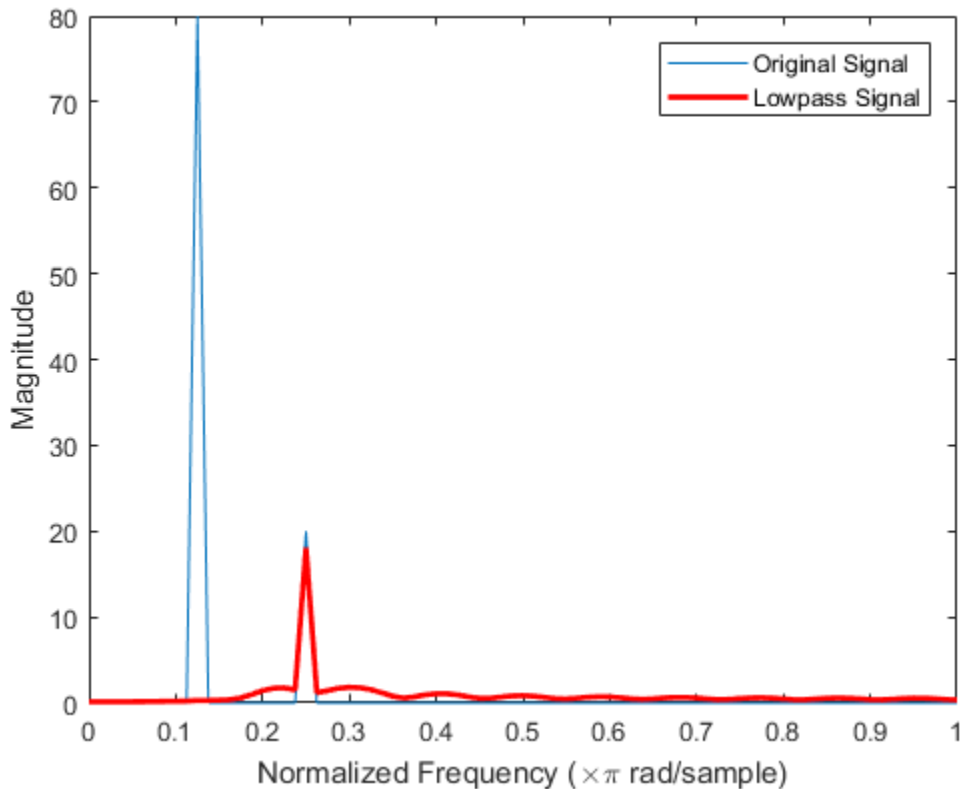

Window Method Highpass Design

Create a filter of order 10 with a 6-dB frequency of 9.6 kHz and a sample rate of 48 kHz. Look at the available design methods.

```
d=fdesign.highpass('N,Fc',10,9600,48000);
```

`designmethods(d)`

Design Methods for class `fdesign.highpass (N,Fc):`

`window`

The only available method is the FIR window method. Design the filter and display its magnitude response.

```
Hd = design(d);
```

```
fvtool(Hd)
```

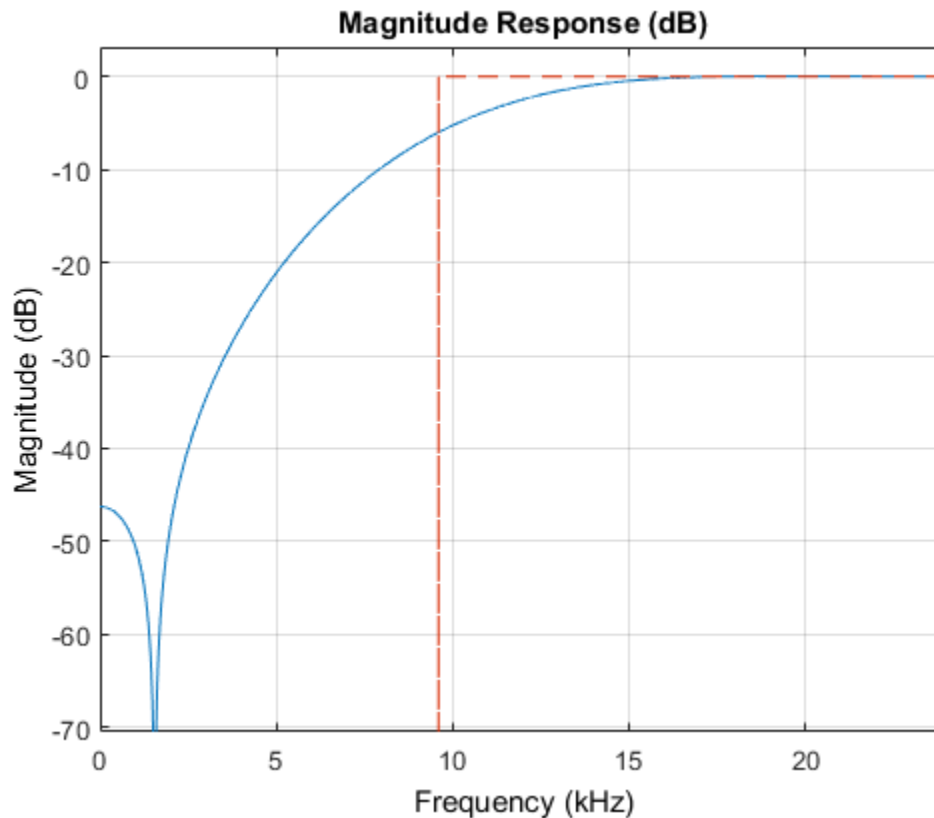

Stopband Constraints

You can specify the shape of the stopband and the rate at which the stopband decays.

Create two FIR equiripple filters with different linear stopband slopes. Specify the passband frequency to be 0.3π rad/sample and the stopband frequency to be 0.35π rad/sample. Specify 1 dB of allowable passband ripple and a stopband attenuation of 60 dB. Design one filter with a 20 dB/(rad/sample) stopband slope and another filter with a slope of 40 dB/(rad/sample).

```
D = fdesign.highpass('Fst,Fp,Ast,Ap',0.3,0.35,60,1);
Hd1 = design(D,'equiripple','StopBandShape','linear','StopBandDecay',20);
Hd2 = design(D,'equiripple','StopBandShape','linear','StopBandDecay',40);
```

Visualize the magnitude responses of the filters.

```
hfvt = fvtool([Hd1 Hd2]);  
legend(hfvt, '20 dB/rad/sample', '40 dB/rad/sample')
```

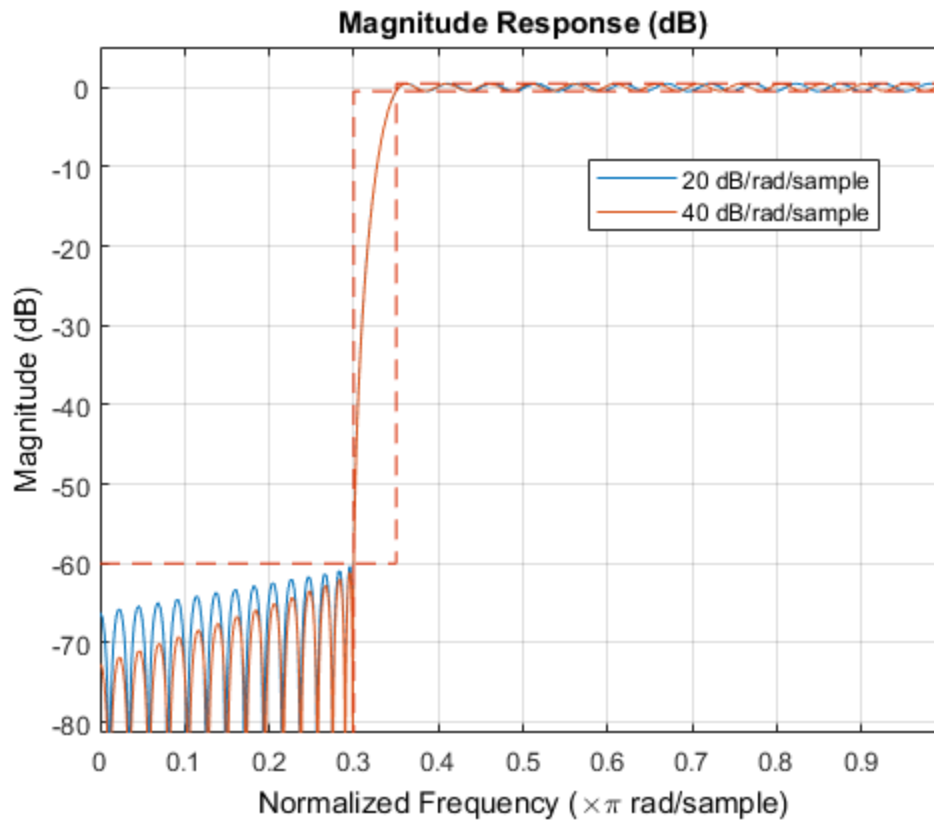

See Also

See Also

[design](#) | [designmethods](#) | [fdesign](#)

Introduced in R2009a

fdesign.hilbert

Hilbert filter specification object

Syntax

```
d = fdesign.hilbert
d = fdesign.hilbert(specvalue1,specvalue2)
d = fdesign.hilbert(spec)
d = fdesign.hilbert(spec,specvalue1,specvalue2)
d = fdesign.hilbert(...,Fs)
d = fdesign.hilbert(...,MAGUNITS)
```

Description

`d = fdesign.hilbert` constructs a default Hilbert filter designer `d` with `N`, the filter order, set to 30 and `TW`, the transition width set to 0.1π radians/sample.

`d = fdesign.hilbert(specvalue1,specvalue2)` constructs a Hilbert filter designer `d` assuming the default specification '`N, TW`'. You input `specvalue1` and `specvalue2` for `N` and `TW`.

`d = fdesign.hilbert(spec)` initializes the filter designer `Specification` property to `spec`. You provide one of the following as input to replace `spec`. The specification options are not case sensitive.

- '`N, TW`' default specification option.

The filter specifications are defined as follows:

- `Ap` — amount of ripple allowed in the pass band in decibels (the default units). Also called `Apass`.
- `N` — filter order.
- `TW` — width of the transition region between the passband and the stopband.

By default, `fdesign.hilbert` assumes that all frequency specifications are provided in normalized frequency units. Also, decibels is the default for all magnitude specifications.

Different specifications may have different design methods available. Use `designmethods(d)` to get a list of the design methods available for a given specification.

`d = fdesign.hilbert(spec,specvalue1,specvalue2)` initializes the filter designer specifications in `spec` with `specvalue1`, `specvalue2`, and so on. To get a description of the specifications `specvalue1` and `specvalue2`, enter

```
get(d, 'description')
```

at the Command prompt.

`d = fdesign.hilbert(...,Fs)` adds the argument `Fs`, specified in Hz to define the sampling frequency. In this case, all frequencies in the specifications are in Hz as well.

`d = fdesign.hilbert(...,MAGUNITS)` specifies the units for any magnitude specification you provide in the input arguments. `MAGUNITS` can be one of

- 'linear' — specify the magnitude in linear units
- 'dB' — specify the magnitude in dB (decibels)
- 'squared' — specify the magnitude in power units

When you omit the `MAGUNITS` argument, `fdesign` assumes that all magnitudes are in decibels. Note that `fdesign` stores all magnitude specifications in decibels (converting to decibels when necessary) regardless of how you specify the magnitudes.

Examples

Hilbert Transformers

Design a Hilbert transformer of order 30 with a transition width of 0.2π rad/sample. Use least-squares minimization to obtain an equiripple linear-phase FIR filter. Plot the zero-phase response in the interval $[-\pi,\pi)$.

```
d = fdesign.hilbert('N,TW',30,0.2);  
Hd = design(d,'equiripple');  
zerophase(Hd,'whole')
```

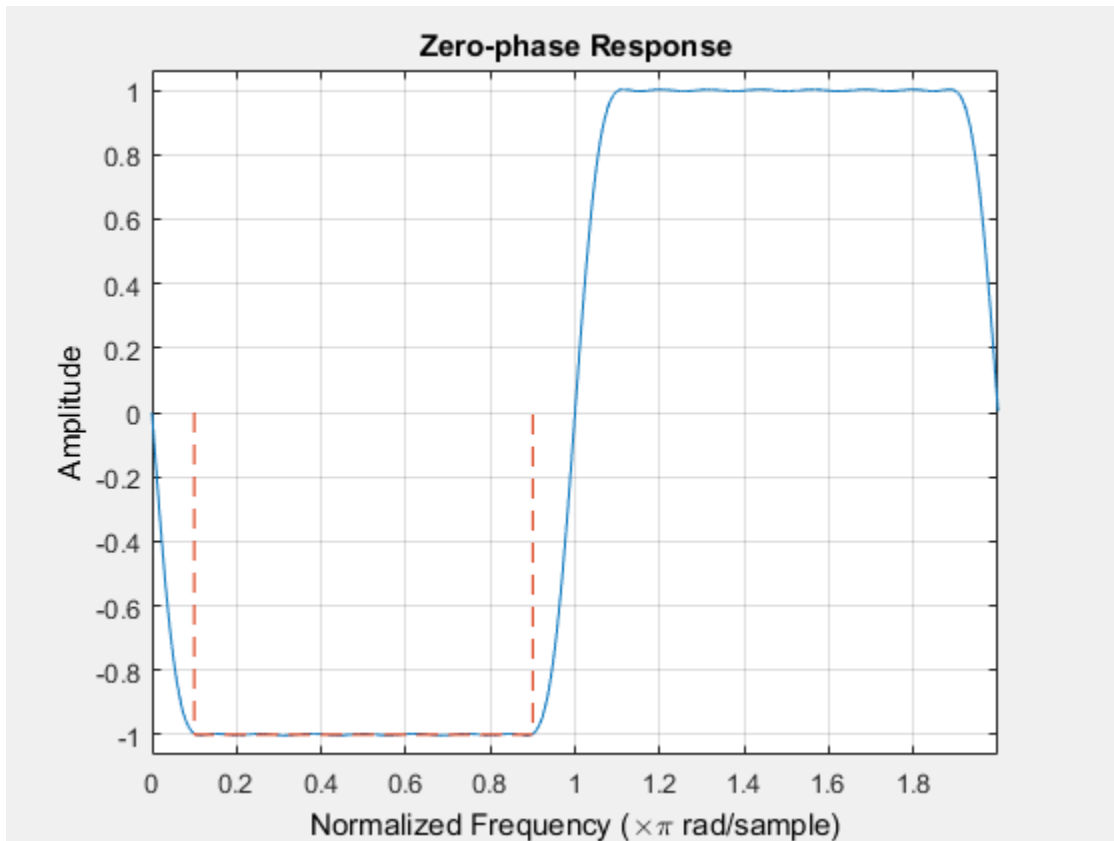
The impulse response of this even-order type-3 filter is antisymmetric.

```
impz(Hd)
```

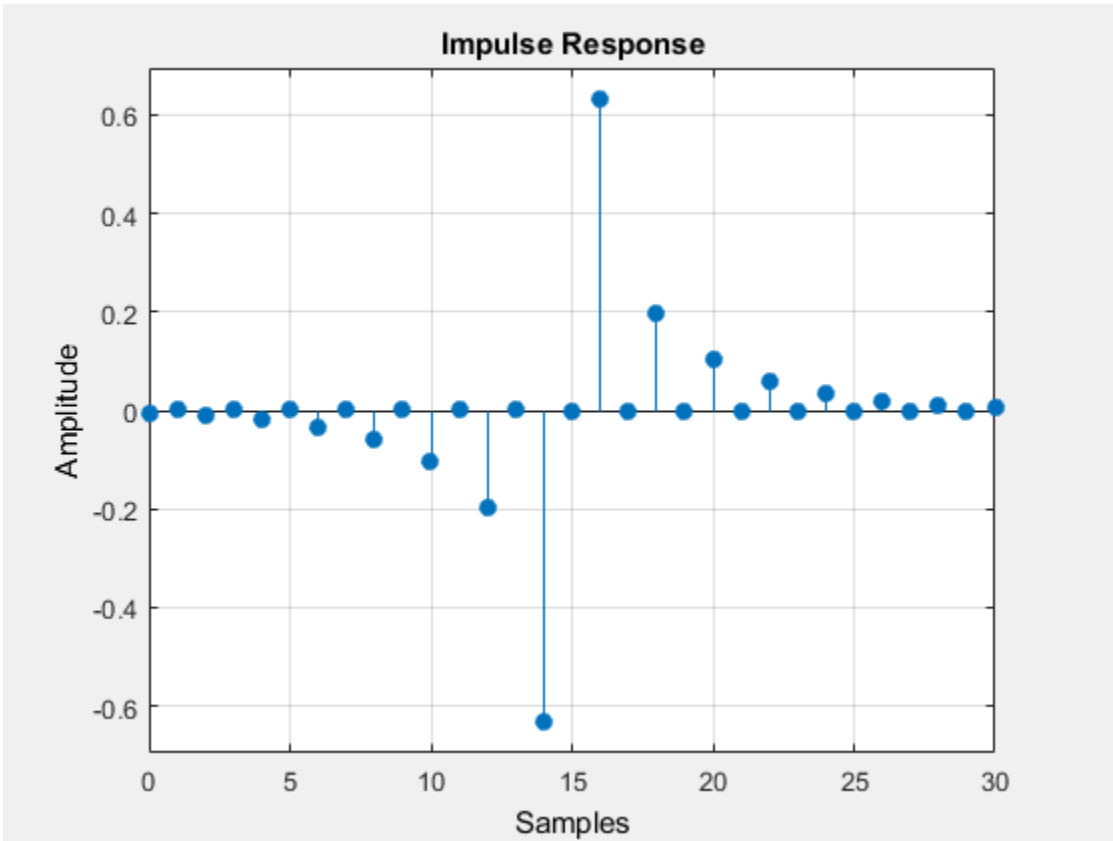

```
ftype = firtype(Hd)
```

```
ftype = 3
```

Apply the filter to a 100-sample sinusoid with a frequency of $\pi/2$ rad/sample. Correct for the filter delay.

```
n = 0:99;
x = cos(pi/2*n);
y = filter(Hd,x);
```

```
Delay = floor(length(Hd.Numerator)/2);
y = y(Delay+1:end);
```

Plot the filter input and output and validate the approximate $\pi/2$ phase shift obtained with the Hilbert transformer.

```
stem([x(1:end-Delay);y'],'filled')
axis([15 25 -1.5 1.5])
grid
legend('Input','Output')
```

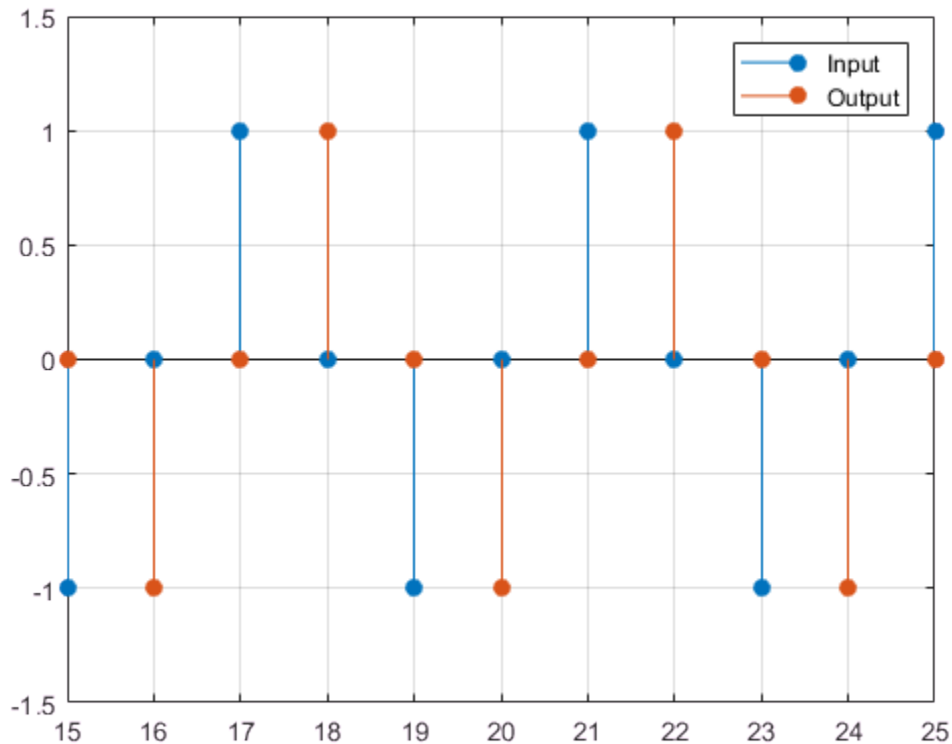

Because the frequency of the discrete-time sinusoid is $\pi/2$ rad/sample, a one-sample shift corresponds to a phase shift of $\pi/2$.

Form the analytic signal and demonstrate that the frequency content of the analytic signal is zero for negative frequencies and approximately twice the spectrum of the input for positive frequencies.

```
x1 = x(1:end-Delay);
xa = x1+1j*y;

hfvt = fvtool(x1,1,xa,1);
legend(hfvt,'Input DFT','Analytic Signal DFT')
```

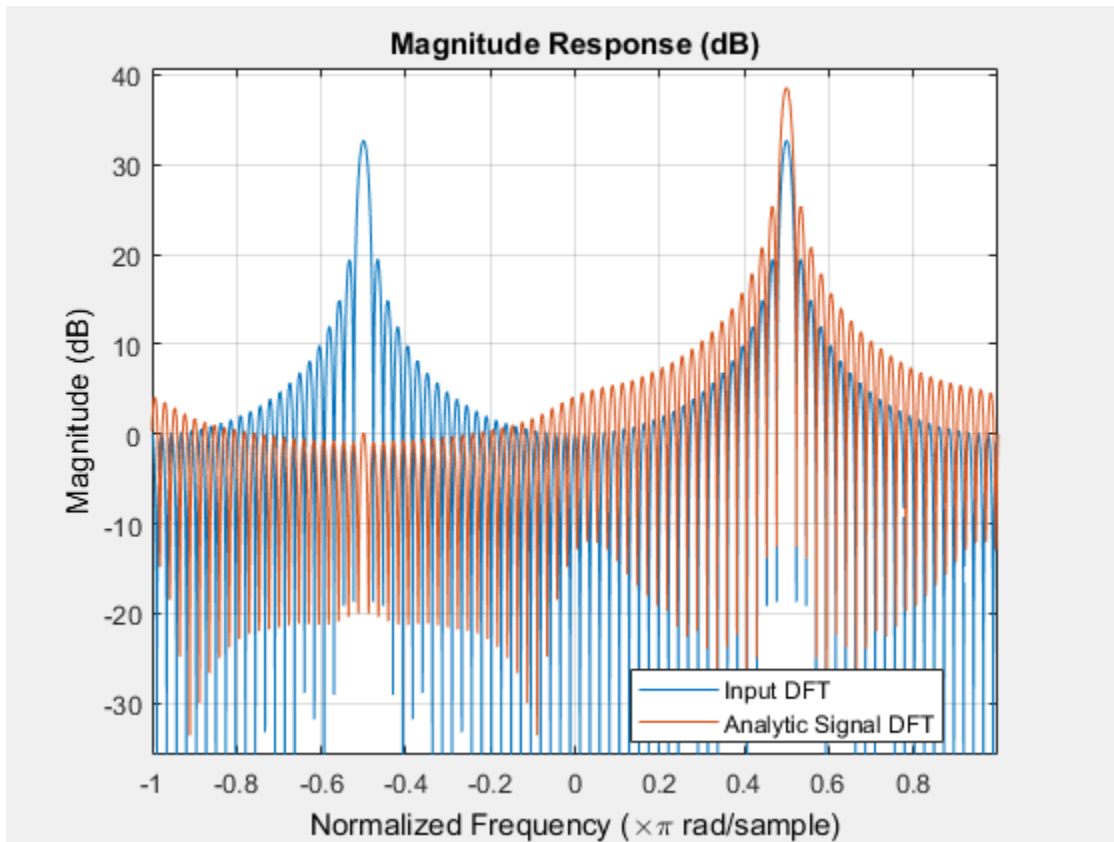

Design a minimum-order Hilbert transformer that has a sample rate of 1 kHz. Specify the passband ripple to be 1 dB. Display the zero-phase response of the filter.

```
d = fdesign.hilbert('TW,Ap',1,0.1,1e3);
hd = design(d,'equiripple');
zerophase(Hd,'whole')
```

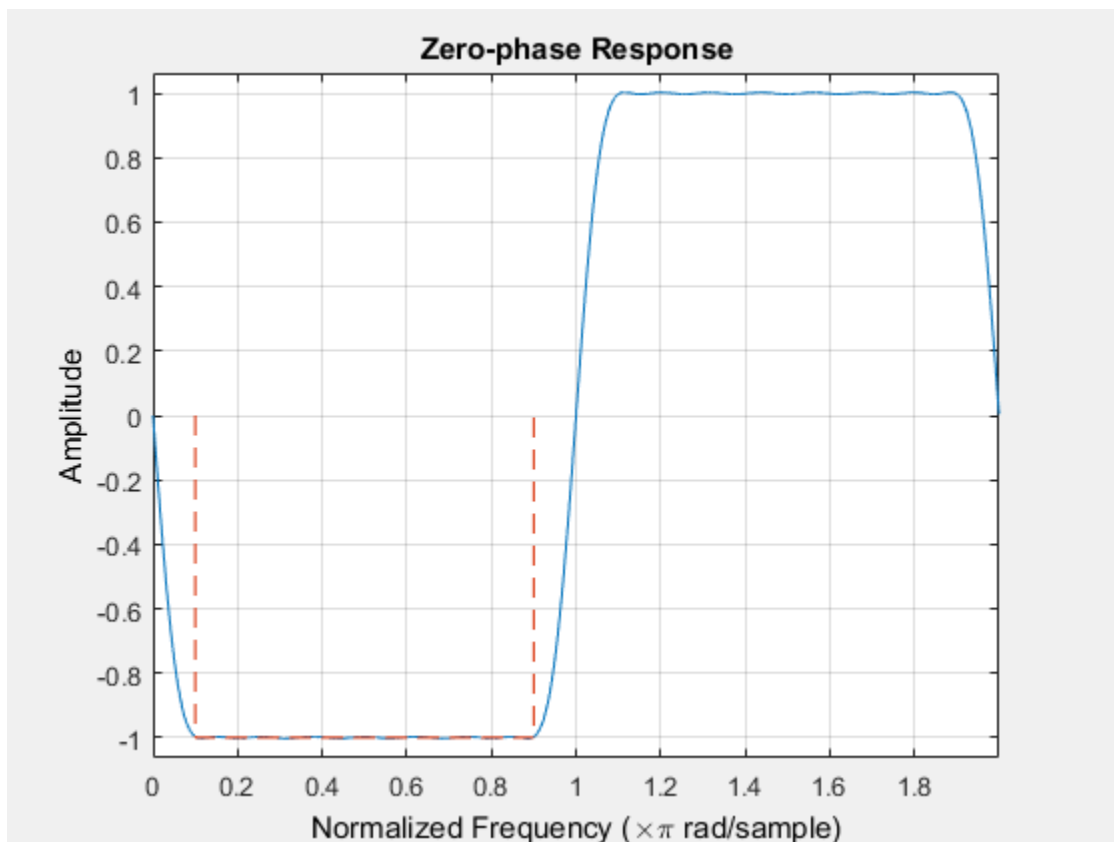

See Also

See Also

design | fdesign | setspecs

Introduced in R2009a

fdesign.lowpass

Lowpass filter specification

Syntax

```
D = fdesign.lowpass
D = fdesign.lowpass(SPEC)
D = fdesign.lowpass(SPEC,specvalue1,specvalue2,...)
D = fdesign.lowpass(specvalue1,specvalue2,specvalue3,specvalue4)
D = fdesign.lowpass(...,Fs)
D = fdesign.lowpass(...,MAGUNITS)
```

Description

`D = fdesign.lowpass` constructs a lowpass filter specification object `D`, applying default values for the default specification option `'Fp,Fst,Ap,Ast'`.

`D = fdesign.lowpass(SPEC)` constructs object `D` and sets the `Specification` property to the entry in `SPEC`. Entries in `SPEC` represent various filter response features, such as the filter order, that govern the filter design. Valid entries for `SPEC` are shown below. The options are not case sensitive.

Note: Specifications options marked with an asterisk require the DSP System Toolbox software.

- `'Fp,Fst,Ap,Ast'` (default option)
- `'N,F3db'`
- `'N,F3db,Ap' *`
- `'N,F3db,Ap,Ast' *`
- `'N,F3db,Ast' *`
- `'N,F3db,Fst' *`
- `'N,Fc'`

- 'N,Fc,Ap,Ast'
- 'N,Fp,Ap'
- 'N,Fp,Ap,Ast'
- 'N,Fp,Fst,Ap' *
- 'N,Fp,F3db' *
- 'N,Fp,Fst'
- 'N,Fp,Fst,Ast' *
- 'N,Fst,Ap,Ast' *
- 'N,Fst,Ast'
- 'Nb,Na,Fp,Fst' *

The filter specifications are defined as follows:

- **Ap** — amount of ripple allowed in the pass band in decibels (the default units). Also called **Apass**.
- **Ast** — attenuation in the stop band in decibels (the default units). Also called **Astop**.
- **F3db** — cutoff frequency for the point 3 dB point below the passband value. Specified in normalized frequency units.
- **Fc** — cutoff frequency for the point 6 dB point below the passband value. Specified in normalized frequency units.
- **Fp** — frequency at the start of the pass band. Specified in normalized frequency units. Also called **Fpass**.
- **Fst** — frequency at the end of the stop band. Specified in normalized frequency units. Also called **Fstop**.
- **N** — filter order.
- **Na** and **Nb** are the order of the denominator and numerator.

Graphically, the filter specifications look similar to those shown in the following figure.

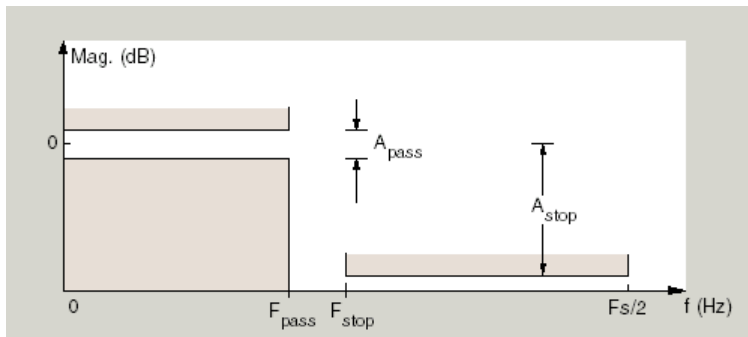

Regions between specification values like F_p and F_{st} are transition regions where the filter response is not explicitly defined.

`D = fdesign.lowpass(SPEC, specvalue1, specvalue2, ...)` constructs an object `D` and sets the specification values at construction time using `specvalue1`, `specvalue2`, and so on for all of the specification variables in `SPEC`.

`D = fdesign.lowpass(specvalue1, specvalue2, specvalue3, specvalue4)` constructs an object `D` with values for the default `Specification` property `'Fp,Fst,Ap,Ast'` using the specifications you provide as input arguments `specvalue1`, `specvalue2`, `specvalue3`, `specvalue4`.

`D = fdesign.lowpass(...,Fs)` adds the argument `Fs`, specified in Hz to define the sampling frequency to use. In this case, all frequencies in the specifications are in Hz as well.

`D = fdesign.lowpass(...,MAGUNITS)` specifies the units for any magnitude specification you provide in the input arguments. `MAGUNITS` can be one of

- `'linear'` — specify the magnitude in linear units
- `'dB'` — specify the magnitude in dB (decibels)
- `'squared'` — specify the magnitude in power units

When you omit the `MAGUNITS` argument, `fdesign` assumes that all magnitudes are in decibels. Note that `fdesign` stores all magnitude specifications in decibels (converting to decibels when necessary) regardless of how you specify the magnitudes.

Examples

Lowpass Filtering of Sinusoids

Lowpass filter a discrete-time signal consisting of two sine waves.

Create a lowpass filter specification object. Specify the passband frequency to be 0.15π rad/sample and the stopband frequency to be 0.25π rad/sample. Specify 1 dB of allowable passband ripple and a stopband attenuation of 60 dB.

```
d = fdesign.lowpass('Fp,Fst,Ap,Ast',0.15,0.25,1,60);
```

Query the valid design methods for your filter specification object, d.

```
designmethods(d)
```

```
Design Methods for class fdesign.lowpass (Fp,Fst,Ap,Ast):
```

```
butter  
cheby1  
cheby2  
ellip  
equiripple  
ifir  
kaiserwin  
multistage
```

Create an FIR equiripple filter and view the filter magnitude response with fvtool.

```
Hd = design(d,'equiripple');  
fvtool(Hd)
```

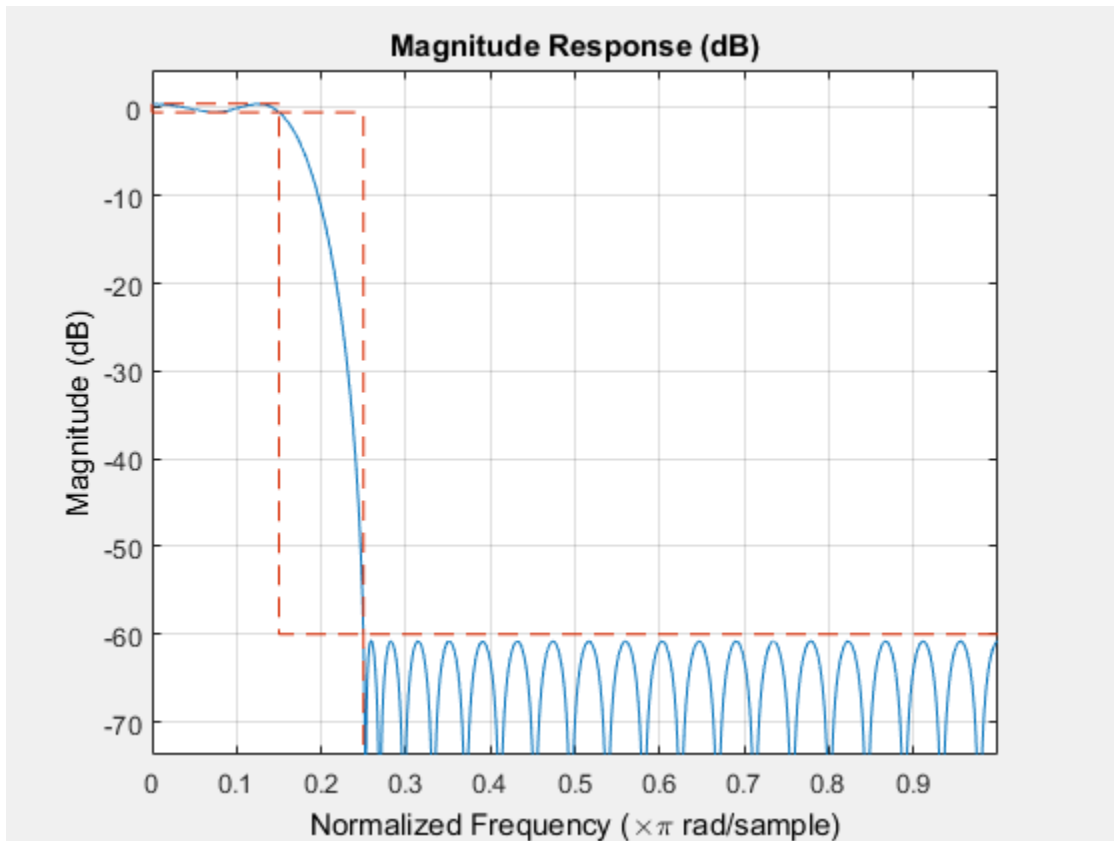

Create a signal consisting of the sum of two discrete-time sinusoids with frequencies of $\pi/8$ and $\pi/4$ rad/sample and amplitudes of 1 and 0.25, respectively. Filter the discrete-time signal with the FIR equiripple filter object, Hd.

```
n = 0:159;
x = (0.25*cos((pi/8)*n)+sin((pi/4)*n));
y = filter(Hd,x);
```

Compute the Fourier transform of the original signal and the filtered signal. Verify that the high-frequency component has been filtered out.

```
freq = 0:(2*pi)/160:pi;
xdft = fft(x);
```

```
ydfc = fft(y);  
  
figure  
plot(freq/pi,abs(xdfc(1:length(x)/2+1)))  
hold on  
plot(freq/pi,abs(ydfc(1:length(y)/2+1)))  
hold off  
  
legend('Original Signal','Filtered Signal')  
ylabel('Magnitude')  
xlabel('Normalized Frequency (\times\pi rad/sample)')
```

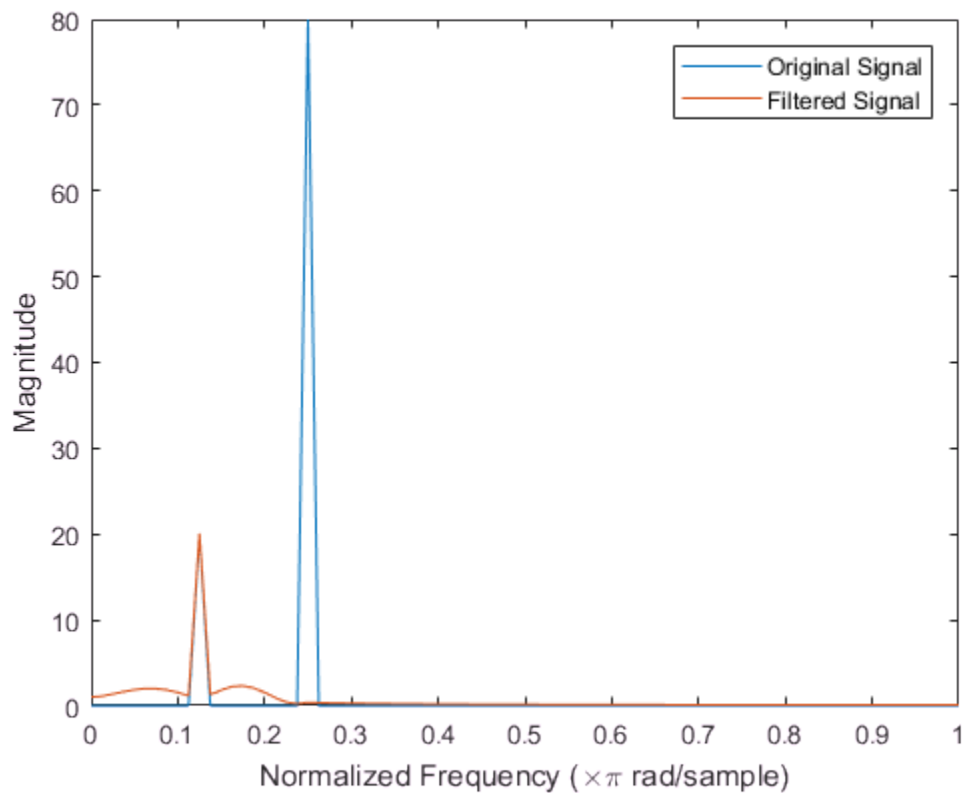

Window Method Lowpass Design

Create a filter of order 10 with a 6-dB frequency of 9.6 kHz and a sampling frequency of 48 kHz. Look at the available design methods.

```
d = fdesign.lowpass('N,Fc',10,9600,48000);  
designmethods(d)
```

```
Design Methods for class fdesign.lowpass (N,Fc):
```

```
window
```

The only valid design method is the FIR window method. Design the filter.

```
Hd = design(d);
```

Display the filter magnitude response. The -6 dB point is at 9.6 kHz, as expected.

```
fvtool(Hd)
```

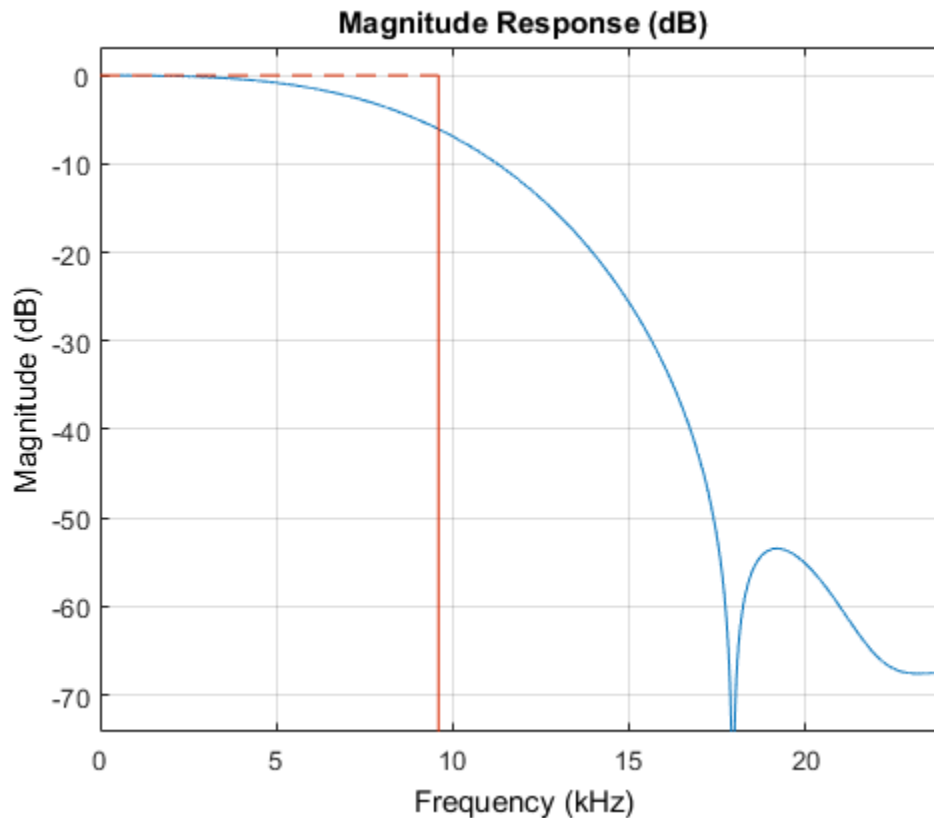

Stopband Shape and Decay

Create an FIR equiripple filter with a passband frequency of 0.2π rad/sample, a stopband frequency of 0.25π rad/sample, a passband ripple of 1 dB, and a stopband attenuation of 60 dB. Design the filter with a 20 dB/rad/sample linear stopband.

```
D = fdesign.lowpass('Fp,Fst,Ap,Ast',0.2,0.25,1,60);
Hd = design(D,'equiripple','StopbandShape','linear','StopbandDecay',20);
```

Visualize the frequency response of the filter.

```
fvtool(Hd)
```

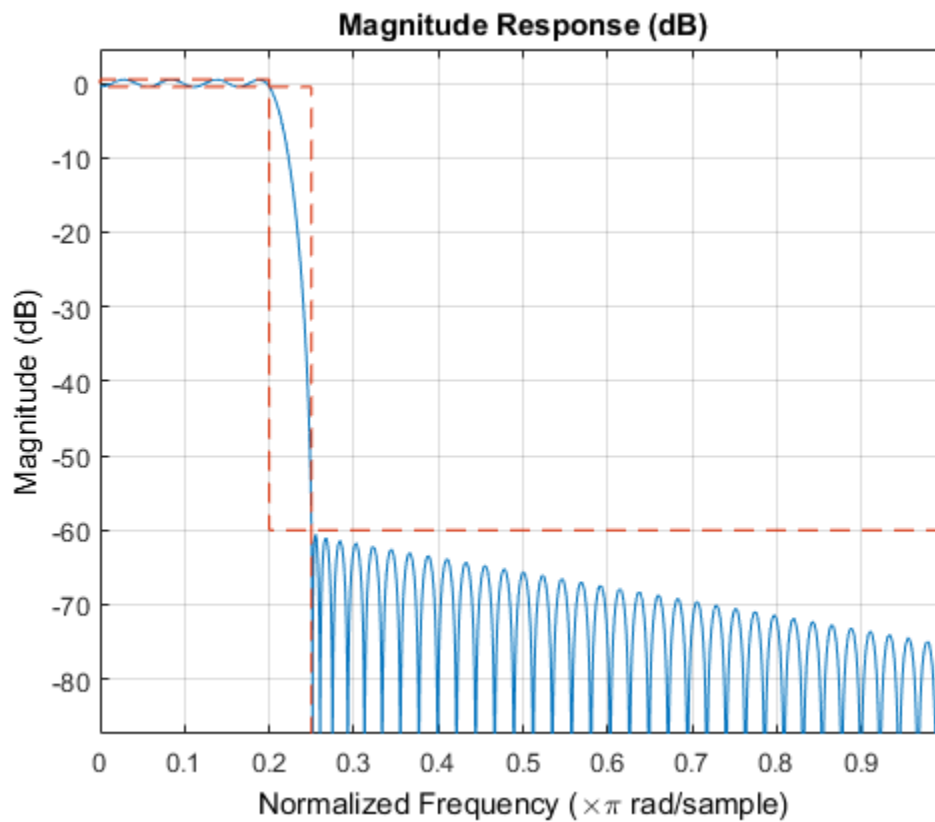

See Also

See Also

`design` | `designmethods` | `fdesign`

Introduced in R2009a

fftfilt

FFT-based FIR filtering using overlap-add method

Syntax

```
y = fftfilt(b,x)
y = fftfilt(b,x,n)
y = fftfilt(d,x)
y = fftfilt(d,x,n)
y = fftfilt(gpuArrayb,gpuArrayX,n)
```

Description

`fftfilt` filters data using the efficient FFT-based method of *overlap-add*, a frequency domain filtering technique that works only for FIR filters.

`y = fftfilt(b,x)` filters the data in vector `x` with the filter described by coefficient vector `b`. It returns the data vector `y`. The operation performed by `fftfilt` is described in the *time domain* by the difference equation:

$$y(n) = b(1)x(n) + b(2)x(n-1) + \dots + b(nb+1)x(n-nb)$$

An equivalent representation is the Z-transform or *frequency domain* description:

$$Y(z) = (b(1) + b(2)z^{-1} + \dots + b(nb+1)z^{-nb}) X(z)$$

By default, `fftfilt` chooses an FFT length and a data block length that guarantee efficient execution time.

If `x` is a matrix, `fftfilt` filters its columns. If `b` is a matrix, `fftfilt` applies the filter in each column of `b` to the signal vector `x`. If `b` and `x` are both matrices with the same number of columns, the *i*th column of `b` is used to filter the *i*th column of `x`.

`y = fftfilt(b,x,n)` uses `n` to determine the length of the FFT. See “Algorithms” on page 1-644 for information.

`y = fftfilt(d,x)` filters the data in vector `x` with a `digitalFilter` object, `d`. Use `designfilt` to generate `d` based on frequency-response specifications.

`y = fftfilt(d,x,n)` uses `n` to determine the length of the FFT.

`y = fftfilt(gpuArrayb,gpuArrayX,n)` filters the data in the `gpuArray` object, `gpuArrayX`, with the FIR filter coefficients in the `gpuArray`, `gpuArrayb`. See “Establish Arrays on a GPU” (Parallel Computing Toolbox) for details on `gpuArray` objects.

Using `fftfilt` with `gpuArray` objects requires Parallel Computing Toolbox software and a CUDA-enabled NVIDIA GPU with compute capability 1.3 or above. See <http://www.mathworks.com/products/parallel-computing/requirements.html> for details. The filtered data, `y`, is a `gpuArray` object. See “Overlap-Add Filtering on the GPU” on page 1-644 for example of overlap-add filtering on the GPU.

`fftfilt` works for both real and complex inputs.

Comparison to filter function

When the input signal is relatively large, it is advantageous to use `fftfilt` instead of `filter`, which performs N multiplications for each sample in `x`, where N is the filter length. `fftfilt` performs 2 FFT operations — the FFT of the signal block of length L plus the inverse FT of the product of the FFTs — at the cost of $\frac{1}{2}L\log_2L$

where L is the block length. It then performs L point-wise multiplications for a total cost of

$$L + L\log_2L = L(1 + \log_2L)$$

multiplications. The cost ratio is therefore

$$L(1+\log_2L) / (NL) = (1 + \log_2L)/N$$

which is approximately \log_2L / N .

Therefore, `fftfilt` becomes advantageous when \log_2L is less than N .

Examples

`fftfilt` and `filter` for Short and Long Filters

Verify that `filter` is more efficient for smaller operands and `fftfilt` is more efficient

for large operands. Filter 10^6 random numbers with two random filters: a short one, with 20 taps, and a long one, with 2000. Use `tic` and `toc` to measure the execution times. Repeat the experiment 100 times to improve the statistics.

```
rng default

N = 100;

shrt = 20;
long = 2000;

tfs = 0;
tls = 0;
tfl = 0;
tll = 0;

for kj = 1:N

    x = rand(1,1e6);

    bshrt = rand(1,shrt);

    tic
    sfs = fftfilt(bshrt,x);
    tfs = tfs+toc/N;

    tic
    sls = filter(bshrt,1,x);
    tls = tls+toc/N;

    blong = rand(1,long);

    tic
    sfl = fftfilt(blong,x);
    tfl = tfl+toc/N;

    tic
    sll = filter(blong,1,x);
    tll = tll+toc/N;

end
```

Compare the average times.

```
fprintf('%4d-tap filter averages: fftfilt: %f s; filter: %f s\n',shrt,tfs,tls)
    20-tap filter averages: fftfilt: 0.280817 s; filter: 0.011027 s

fprintf('%4d-tap filter averages: fftfilt: %f s; filter: %f s\n',long,tfl,tll)
```

2000-tap filter averages: fftfilt: 0.083303 s; filter: 0.118255 s

Overlap-Add Filtering on the GPU

The following example requires Parallel Computing Toolbox software and a CUDA-enabled NVIDIA GPU with compute capability 1.3 or above. See <http://www.mathworks.com/products/parallel-computing/requirements.html> for details.

Create a signal consisting of a sum of sine waves in white Gaussian additive noise. The sine wave frequencies are 2.5, 5, 10, and 15 kHz. The sampling frequency is 50 kHz.

```
Fs = 50e3;
t = 0:1/Fs:10-(1/Fs);
x = cos(2*pi*2500*t)+0.5*sin(2*pi*5000*t)+0.25*cos(2*pi*10000*t)+ ...
    0.125*sin(2*pi*15000*t)+randn(size(t));
```

Design a lowpass FIR equiripple filter using `designfilt`.

```
d = designfilt('lowpassfir','SampleRate',Fs, ...
    'PassbandFrequency',5500,'StopbandFrequency',6000, ...
    'PassbandRipple',0.5,'StopbandAttenuation',50);
B = d.Coefficients;
```

Filter the data on the GPU using the overlap-add method. Put the data on the GPU using `gpuArray`. Return the output to the MATLAB workspace using `gather` and plot the power spectral density estimate of the filtered data.

```
y = fftfilt(gpuArray(B),gpuArray(x));
periodogram(gather(y),rectwin(length(y)),length(y),50e3)
```

Algorithms

`fftfilt` uses `fft` to implement the *overlap-add method* [1], a technique that combines successive frequency domain filtered blocks of an input sequence. `fftfilt` breaks an input sequence x into length L data blocks, where L must be greater than the filter length N .

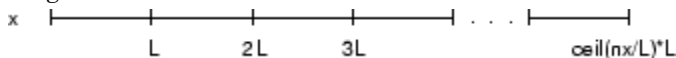

and convolves each block with the filter b by

```
y = ifft(fft(x(i:i+L-1),nfft).*fft(b,nfft));
```

where `nfft` is the FFT length. `fftfilt` overlaps successive output sections by $n - 1$ points, where n is the length of the filter, and sums them.

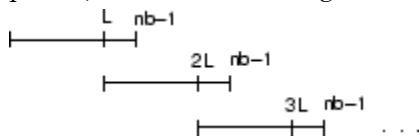

`fftfilt` chooses the key parameters L and `nfft` in different ways, depending on whether you supply an FFT length n and on the lengths of the filter and signal. If you do not specify a value for n (which determines FFT length), `fftfilt` chooses these key parameters automatically:

- If `length(x)` is greater than `length(b)`, `fftfilt` chooses values that minimize the number of blocks times the number of flops per FFT.
- If `length(b)` is greater than or equal to `length(x)`, `fftfilt` uses a single FFT of length

$$2^{\text{nextpow2}(\text{length}(b) + \text{length}(x) - 1)}$$

This essentially computes

$$y = \text{ifft}(\text{fft}(B, \text{nfft}) .* \text{fft}(X, \text{nfft}))$$

If you supply a value for n , `fftfilt` chooses an FFT length, `nfft`, of $2^{\text{nextpow2}(n)}$ and a data block length of `nfft - length(b) + 1`. If n is less than `length(b)`, `fftfilt` sets n to `length(b)`.

References

- [1] Oppenheim, Alan V., Ronald W. Schafer, and John R. Buck. *Discrete-Time Signal Processing*. 2nd Ed. Upper Saddle River, NJ: Prentice Hall, 1999.

See Also

`conv` | `designfilt` | `digitalFilter` | `filter` | `filtfilt`

Introduced before R2006a

fillgaps

Fill gaps using autoregressive modeling

Syntax

```
y = fillgaps(x)  
y = fillgaps(x,maxlen)  
y = fillgaps(x,maxlen,order)
```

```
fillgaps( ___ )
```

Description

`y = fillgaps(x)` replaces any NaNs present in a signal `x` with estimates extrapolated from forward and reverse autoregressive fits of the remaining samples. If `x` is a matrix, then the function treats each column as an independent channel.

`y = fillgaps(x,maxlen)` specifies the maximum number of samples to use in the estimation. Use this argument when your signal is not well characterized throughout its range by a single autoregressive process.

`y = fillgaps(x,maxlen,order)` specifies the order of the autoregressive model used to reconstruct the gaps.

`fillgaps(___)` with no output arguments plots the original samples and the reconstructed signal. This syntax accepts any input arguments from previous syntaxes.

Examples

Fill Gaps in Audio File

Load a speech signal sampled at $F_s = 7418$ Hz. The file contains a recording of a female voice saying the word "MATLAB®." Play the sound.

```
load mtlb
```

```
% To hear, type soundsc(mtlb,Fs)
```

Simulate a situation in which a noisy transmission channel corrupts parts of the signal irretrievably. Introduce gaps of random length roughly every 500 samples. Reset the random number generator for reproducible results.

```
rng default
```

```
gn = 3;
```

```
mt = mtlb;
```

```
gl = randi([300 600],gn,1);
```

```
for kj = 1:gn
```

```
    mt(kj*1000+randi(100)+(1:gl(kj))) = NaN;
```

```
end
```

Plot the original and corrupted signals. Offset the corrupted signal for ease of display. Play the signal with the gaps.

```
plot([mtlb mt+4])
```

```
legend('Original','Corrupted')
```

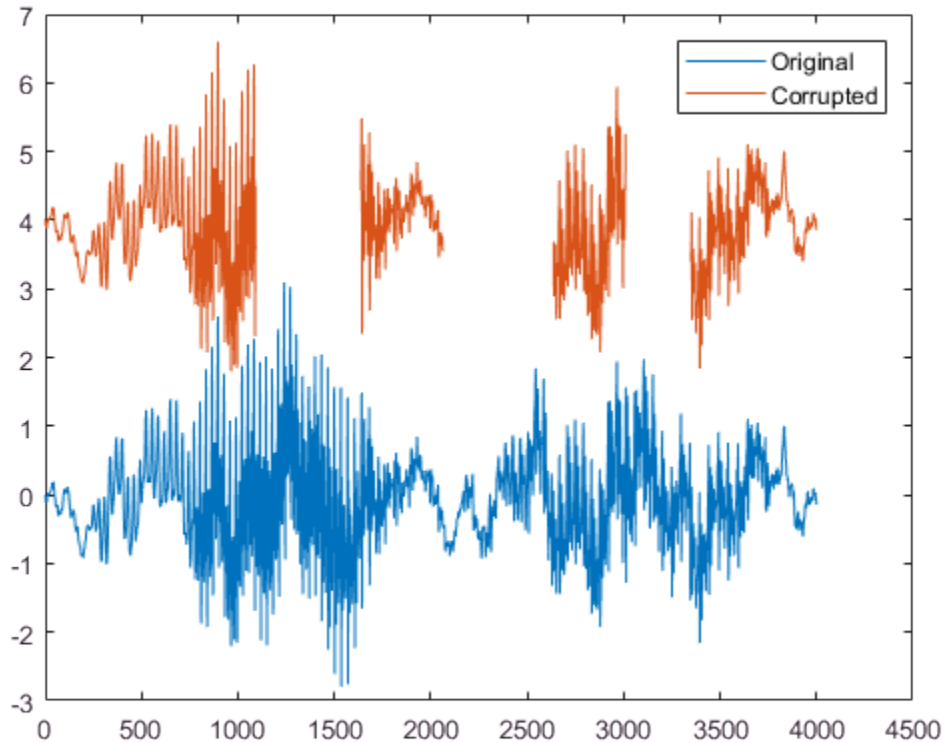

```
% To hear, type soundsc(mt,Fs)
```

Reconstruct the signal using an autoregressive process. Use `fillgaps` with the default settings. Plot the original and reconstructed signals, again using an offset. Play the reconstructed signal.

```
lb = fillgaps(mt);  
  
plot([mt lb lb+4])  
legend('Original', 'Reconstructed')
```

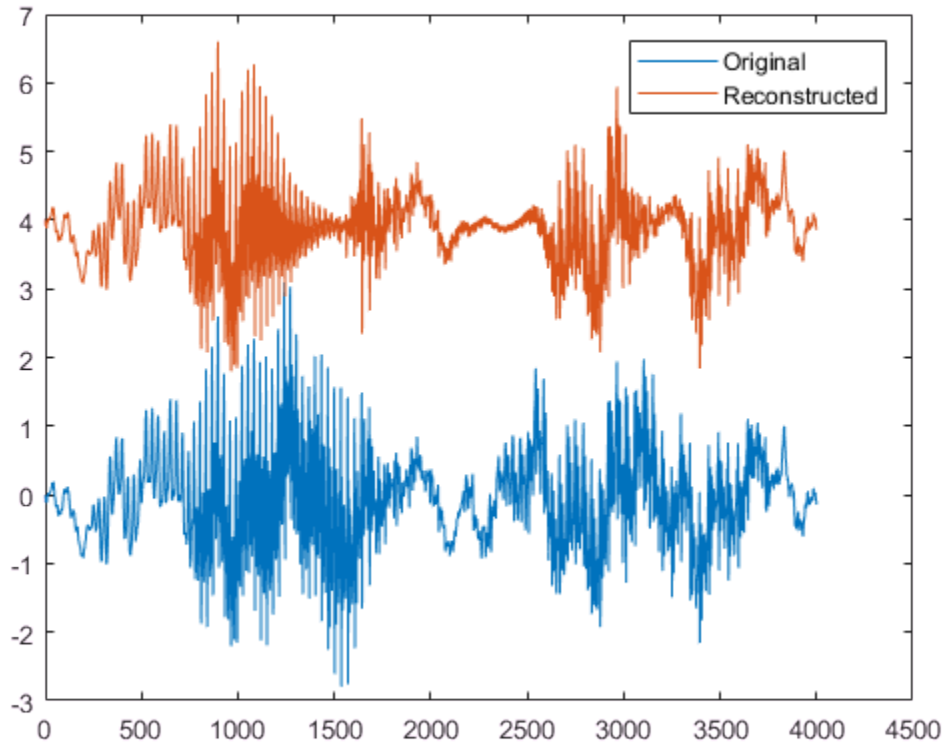

```
% To hear, type soundsc(lb,Fs)
```

Fill Gaps in Two-Dimensional Data

Load a file that contains depth measurements of a mold used to mint a United States penny. The data, taken at the National Institute of Standards and Technology, are sampled on a 128-by-128 grid.

```
load penny
```

Draw a contour plot with 25 copper-colored contour lines.

```
nc = 25;  
  
contour(P,nc)  
colormap copper  
axis ij square
```

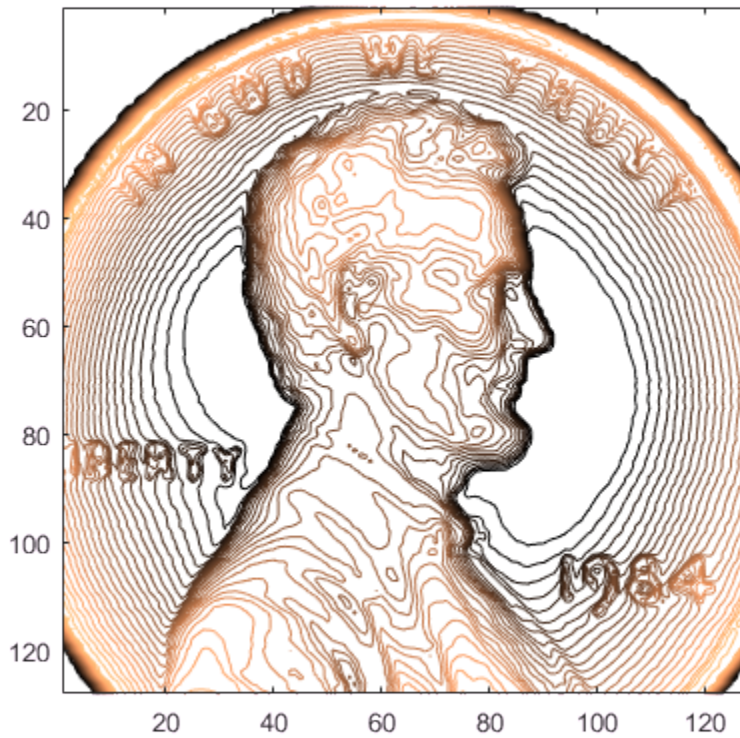

Introduce four 10-by-10 gaps into the data. Draw a contour plot of the corrupted signal.

```
P(50:60,80:90) = NaN;  
P(100:110,20:30) = NaN;  
P(100:110,100:110) = NaN;  
P(20:30,110:120) = NaN;
```



```

contour(P,nc)
colormap copper
axis ij square

```

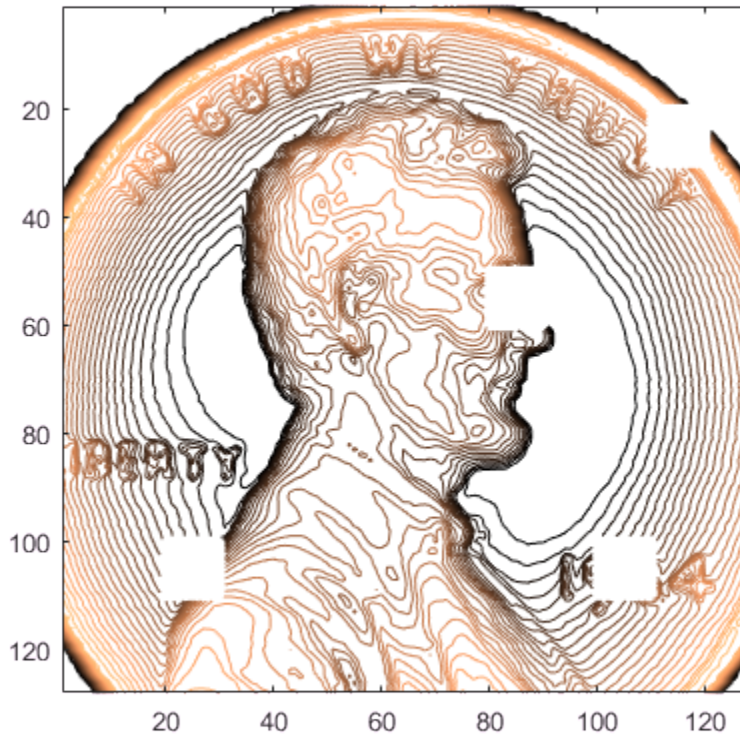

Use `fillgaps` to reconstruct the data, treating each column as an independent channel. Specify an 8th-order autoregressive model extrapolated from 30 samples at each end. Draw a contour plot of the reconstruction.

```

q = fillgaps(P,30,8);

contour(q,nc)
colormap copper
axis ij square

```

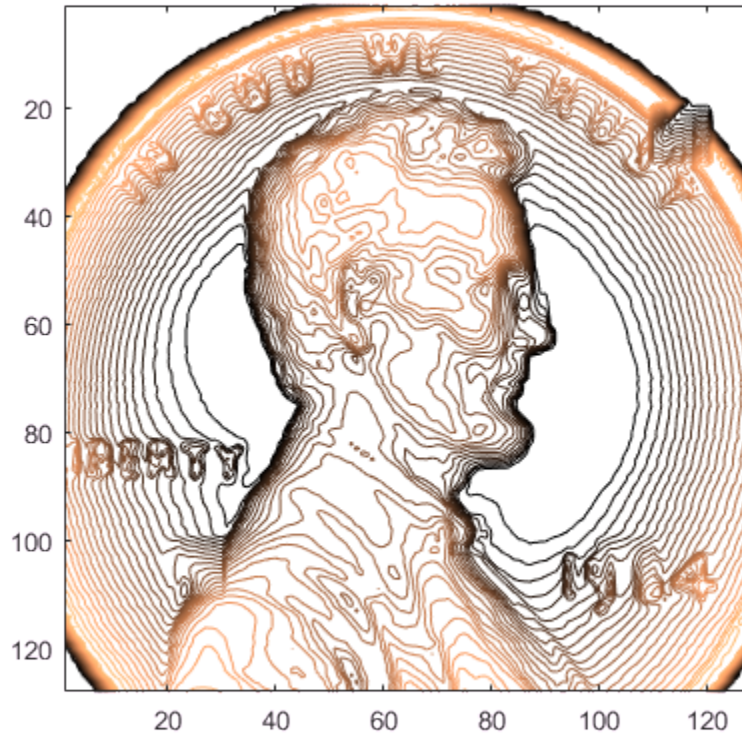

Fill Gaps in Function

Generate a function that consists of the sum of two sinusoids and a Lorentzian curve. The function is sampled at 200 Hz for 2 seconds. Plot the result.

```
x = -1:0.005:1;
f = 1./(1+10*x.^2)+sin(2*pi*3*x)/10+cos(25*pi*x)/10;
plot(x,f)
```

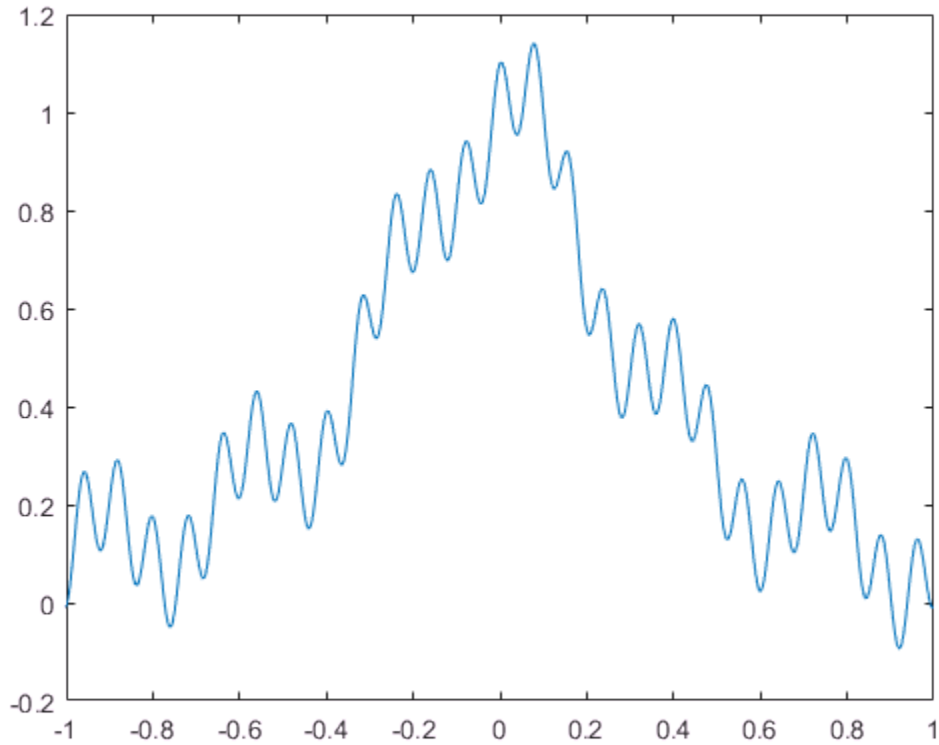

Insert gaps at intervals $(-0.8,-0.6)$, $(-0.2,0.1)$, and $(0.4,0.7)$.

```
h = f;
```

```
h(x > -0.8 & x < -0.6) = NaN;
```

```
h(x > -0.2 & x < 0.1) = NaN;
```

```
h(x > 0.4 & x < 0.7) = NaN;
```

Fill the gaps using the default settings of `fillgaps`. Plot the original and reconstructed functions.

```
y = fillgaps(h);
```

```
plot(x,f, 'r.',x,y)
```

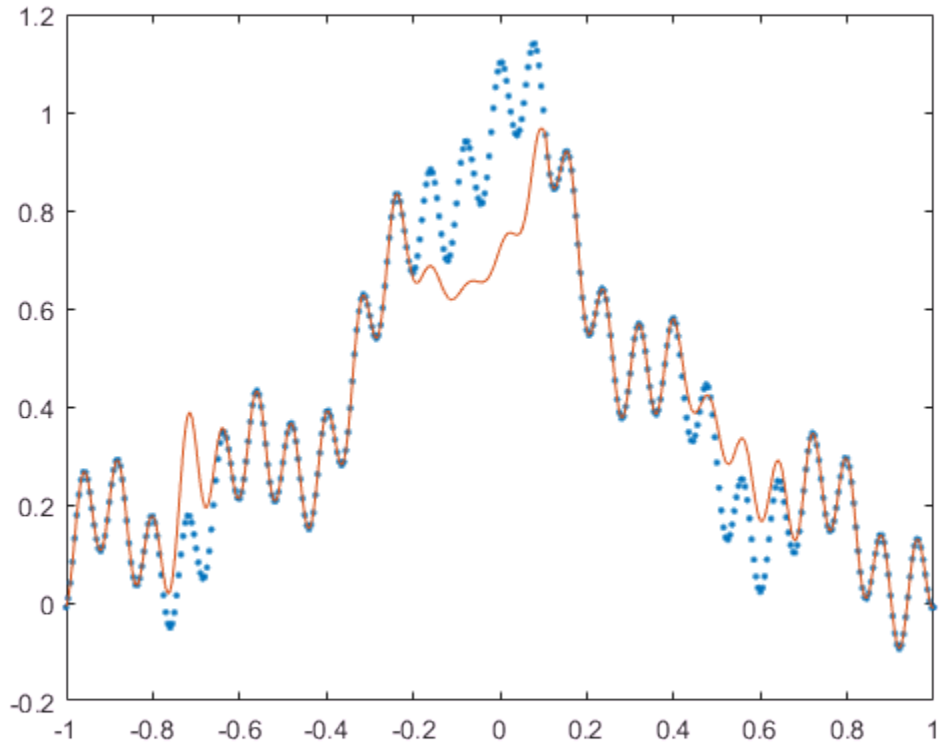

Repeat the computation, but now specify a maximum prediction-sequence length of 3 samples and a model order of 1. Plot the original and reconstructed functions. At its simplest, `fillgaps` performs a linear fit.

```
y = fillgaps(h,3,1);
```

```
plot(x,f, ' . ',x,y)
```

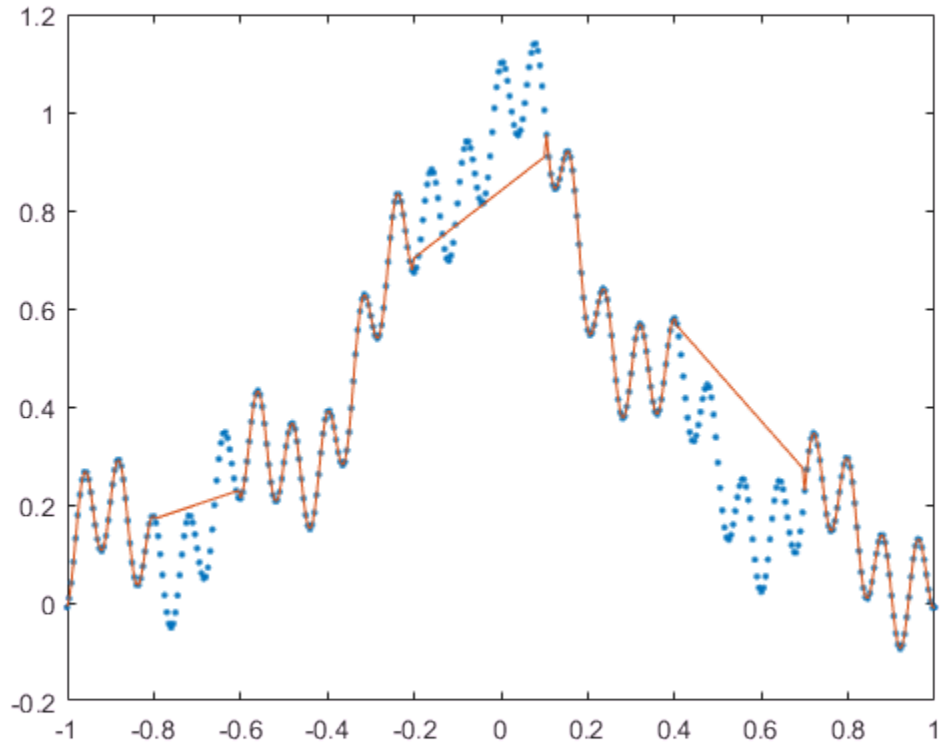

Specify a maximum prediction-sequence length of 80 samples and a model order of 40.
Plot the original and reconstructed functions.

```
y = fillgaps(h,80,40);
```

```
plot(x,f, ' . ',x,y)
```

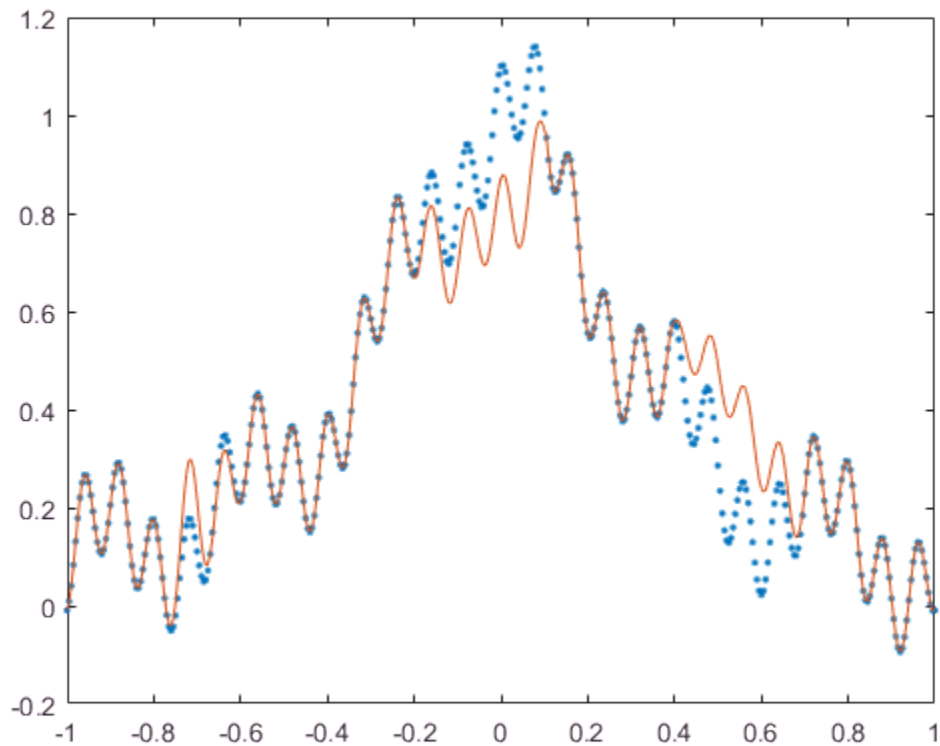

Change the model order to 70. Plot the original and reconstructed functions.

```
y = fillgaps(h,80,70);
```

```
plot(x,f,'.',x,y)
```

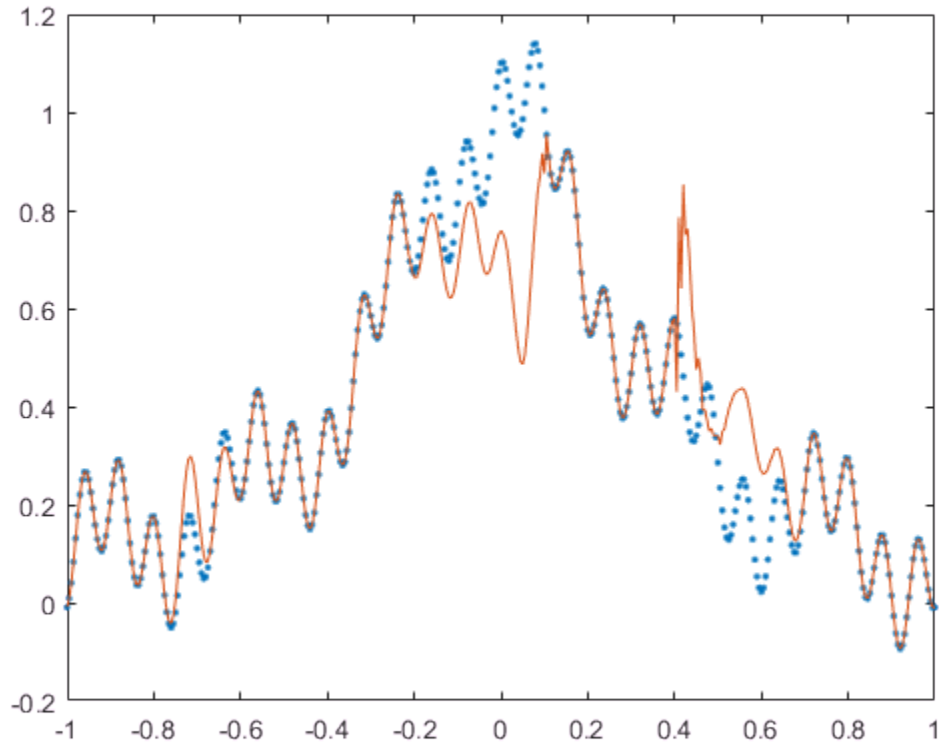

The reconstruction is imperfect because very high model orders often have problems with finite precision.

Fill Gaps in Chirp

Generate a multichannel signal consisting of two instances of a chirp sampled at 1 kHz for 1 second. The frequency of the chirp is zero at 0.3 seconds and increases linearly to reach a final value of 40 Hz. Each instance has a different DC value.

```
Fs = 1000;  
t = 0:1/Fs:1-1/Fs;  
r = chirp(t-0.3,0,0.7,40);  
f = 1.1;
```

```
q = [r-f;r+f]';
```

Introduce gaps to the signal. One of the gaps covers the low-frequency region, and the other covers the high-frequency region.

```
gap = (460:720);
q(gap-300,1) = NaN;
q(gap+200,2) = NaN;
```

Fill the gaps using the default parameters. Plot the reconstructed signals.

```
y = fillgaps(q);
```

```
plot(t,y)
```

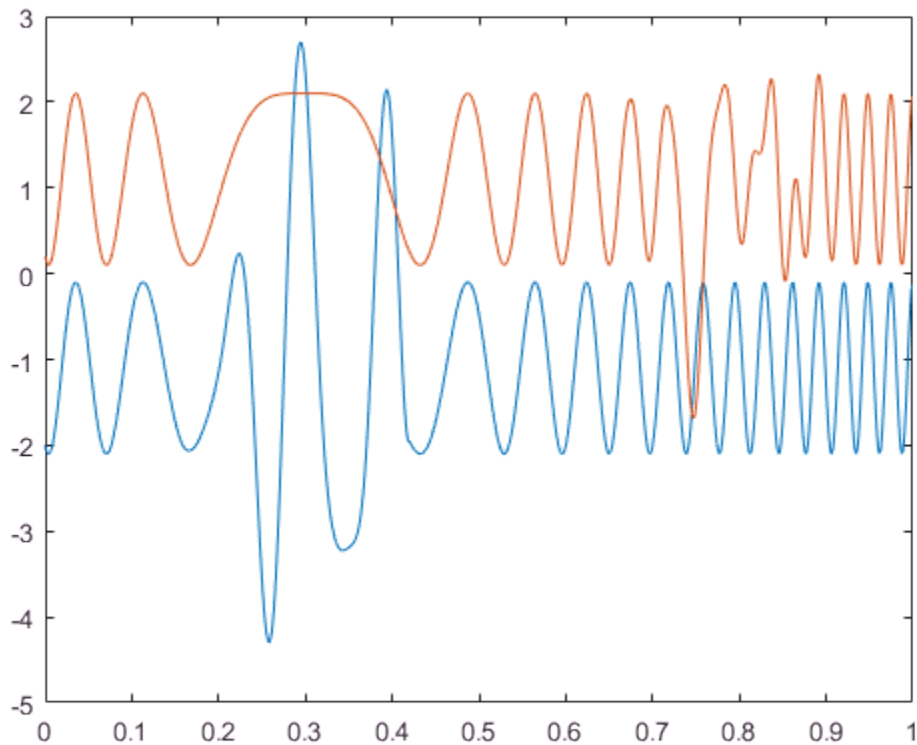

Fill the gaps by fitting 14th-order autoregressive models to the signal. Limit the models to incorporate 15 samples on the end of each gap. Use the functionality of `fillgaps` to plot the reconstructions.

```
fillgaps(q,15,14)
```

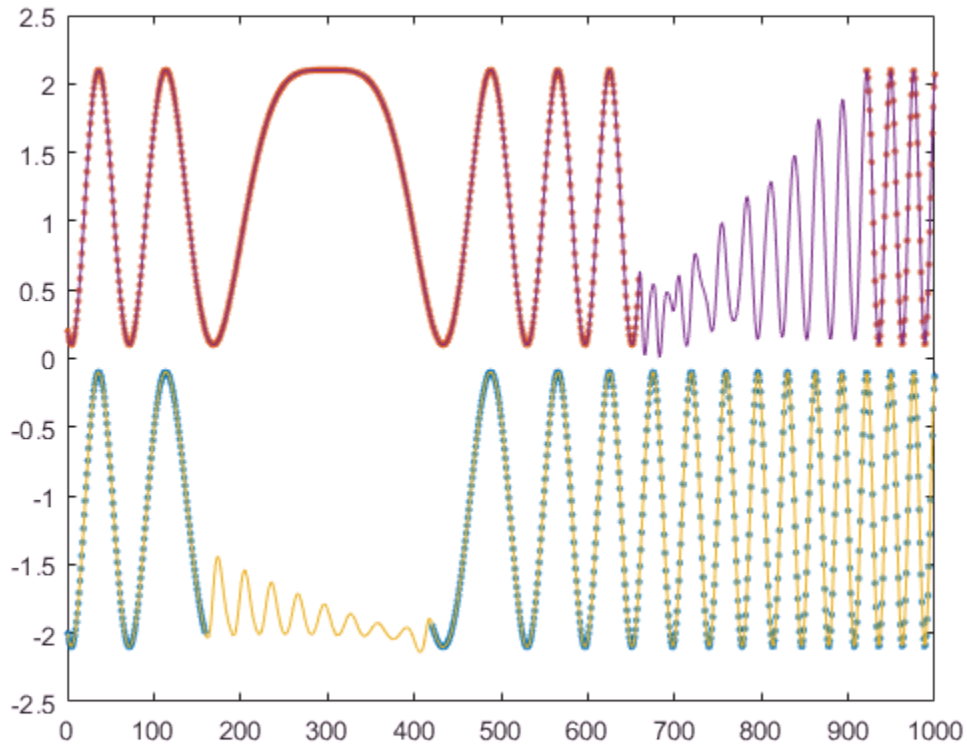

Increase the number of samples to use in the estimation to 150. Increase the model order to 140.

```
fillgaps(q,150,140)
```

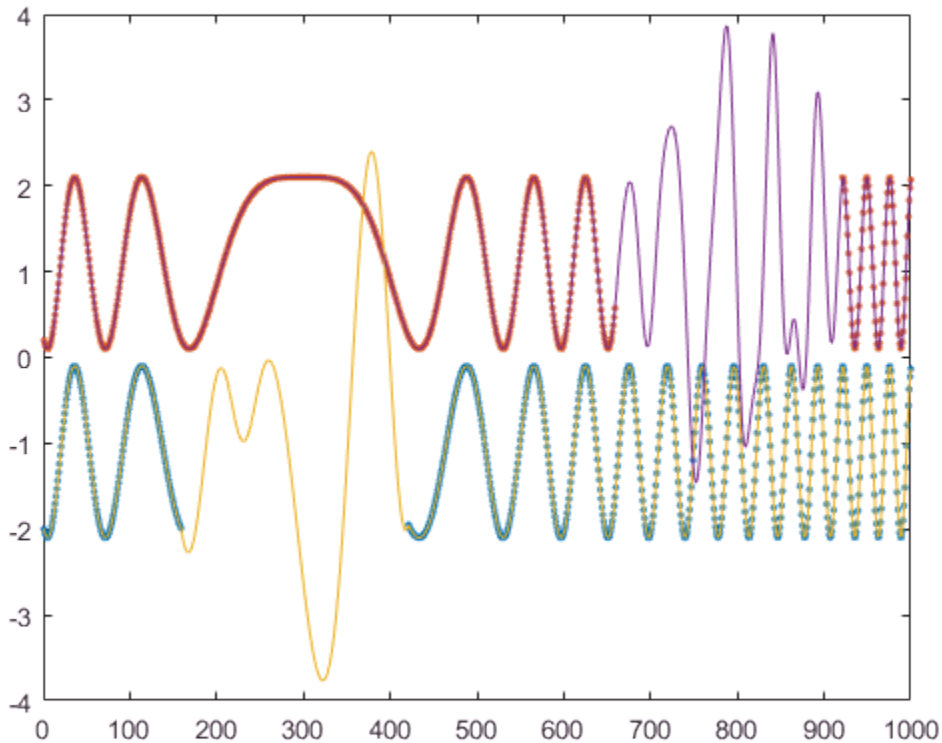

Input Arguments

x — Input signal

vector | matrix

Input signal, specified as a vector or matrix. If **x** is a matrix, then its columns are treated as independent channels. **x** contains NaNs to represent missing samples.

Example: `cos(pi/4*(0:159))+reshape(ones(32,1)*[0 NaN 0 NaN 0],1,160)` is a single-channel row-vector signal missing 40% of its samples.

Example: `cos(pi./[4;2]*(0:159))'+reshape(ones(64,1)*[0 NaN 0 NaN 0],160,2)` is a two-channel signal with large gaps.

Data Types: `single` | `double`

Complex Number Support: Yes

maxlen — Maximum length of prediction sequences

positive integer

Maximum length of prediction sequences, specified as a positive integer. If you leave `maxlen` unspecified, then `fillgaps` iteratively fits autoregressive models using all previous points for forward estimation and all future points for backward estimation.

Data Types: `single` | `double`

order — Autoregressive model order

'aic' (default) | positive integer

Autoregressive model order, specified as 'aic' or a positive integer. The order is truncated when `order` is infinite or when there are not enough available samples. If you specify `order` as 'aic', or leave it unspecified, then `fillgaps` selects the order that minimizes the Akaike information criterion.

Data Types: `single` | `double` | `char`

Output Arguments

y — Reconstructed signal

vector | matrix

Reconstructed signal, returned as a vector or matrix.

References

- [1] Kay, Steven M. *Modern Spectral Estimation: Theory and Application*. Englewood Cliffs, NJ: Prentice Hall, 1988.
- [2] Orfanidis, Sophocles J. *Optimum Signal Processing: An Introduction*. 2nd Edition. New York: McGraw-Hill, 1996.
- [3] Akaike, Hirotugu. "Fitting Autoregressive Models for Prediction." *Annals of the Institute of Statistical Mathematics*. Vol.21, 1969, pp.243–247.

See Also

See Also

arburg | resample

Introduced in R2016a

filter

Filter data with recursive (IIR) or nonrecursive (FIR) filter

Description

`filter` is a MATLAB function.

Signal-Specific Information

Filter Using `digitalFilter` Objects

Use `filter` in the form `y = filter(d,x)` to filter an input signal, `x`, with a `digitalFilter`, `d`, and obtain output data, `y`.

Use `designfilt` to generate `d` based on frequency-response specifications.

`x` can be a double- or single-precision vector. It can also be a matrix with as many columns as there are input channels.

FIR Filters

The denominator of FIR filters is, by definition, equal to 1. To use the `filter` function with the `b` coefficients from an FIR function, use `y = filter(b,1,x)`.

See Also

`designfilt` | `digitalFilter` | `fftfilt` | `filtfilt` | `sosfilt`

Introduced before R2006a

filterBuilder

Interactive filter design

Syntax

```
filterBuilder(h)  
filterBuilder('response')
```

Description

`filterBuilder` starts an interactive tool for building filters. It relies on the `fdesign` object-object oriented filter design paradigm, and is intended to reduce development time during the filter design process. `filterBuilder` uses a specification-centered approach to find the best algorithm for the desired response.

Note: You must have the Signal Processing Toolbox installed to use `fdesign` and `filterBuilder`. Some of the features described below may be unavailable if your installation does not additionally include the DSP System Toolbox. You can verify the presence of both toolboxes by typing `ver` at the command prompt.

For more information on how to use `filterBuilder`, see “Filter Builder Design Process”.

To use `filterBuilder`, enter `filterBuilder` at the MATLAB command line using one of three approaches:

- Simply enter `filterBuilder`. MATLAB opens a dialog for you to select a filter response type. After you select a filter response type, `filterBuilder` launches the appropriate filter design dialog box.
- Enter `filterBuilder(h)`, where `h` is an existing filter object. For example, if `h` is a bandpass filter, `filterBuilder(h)` opens the bandpass filter design dialog box. The `h` object must have been created using `filterBuilder` or using `fdesign`.

Note: You must have the DSP System Toolbox software to create and import filter System objects.

- Enter `filterBuilder('response')` to replace *response* with a response method from the following table. MATLAB opens a filter design dialog that corresponds to the specified response.

Note: You must have the DSP System Toolbox software to implement a number of the filter designs listed in the following table. If you only have the Signal Processing Toolbox software, you can design a limited set of the following filter-response types.

Response Method	Description of Resulting Filter Design	Filter Object
arbgrpdelay	Arbitrary group delay filter design	<code>fdesign.arbgrpdelay</code>
arbmag	Arbitrary magnitude filter design	<code>fdesign.arbmag</code>
arbmagnphase	Arbitrary response filter (magnitude and phase)	<code>fdesign.arbmagnphase</code>
audioweighting	Audio weighting filter	<code>fdesign.audioweighting</code>
bandpass or bp	Bandpass filter	<code>fdesign.bandpass</code>
bandstop or bs	Bandstop filter	<code>fdesign.bandstop</code>
cic	CIC filter	<code>fdesign.decimator(M,'cic',...)</code> or <code>fdesign.interpolator(L,'cic',...)</code> See <code>fdesign.decimator</code> and <code>fdesign.interpolator</code>
ciccomp	CIC compensator	<code>fdesign.ciccomp</code>
comb	Comb filter	<code>fdesign.comb</code>
diff	Differentiator filter	<code>fdesign.differentiator</code>
fracdelay	Fractional delay filter	<code>fdesign.fracdelay</code>

Response Method	Description of Resulting Filter Design	Filter Object
halfband or hb	Halfband filter	fdesign.halfband
highpass or hp	Highpass filter	fdesign.highpass
hilb	Hilbert filter	fdesign.hilbert
isinc, isinclp, or isinchp	Inverse sinc lowpass or highpass filter	fdesign.isinclp and fdesign.isinchp
lowpass or lp	Lowpass filter (default)	fdesign.lowpass
notch	Notch filter	fdesign.notch
nyquist	Nyquist filter	fdesign.nyquist
octave	Octave filter	fdesign.octave
parameq	Parametric equalizer filter	fdesign.parameq
peak	Peak filter	fdesign.peak

Note: Because they do not change the filter structure, the magnitude specifications and design method are tunable when using `filterBuilder`.

Filter Builder Design Panes

Main Design Pane

The main pane of Filter Builder varies depending on the filter response type, but the basic structure is the same. The following figure shows the basic layout of the dialog box.

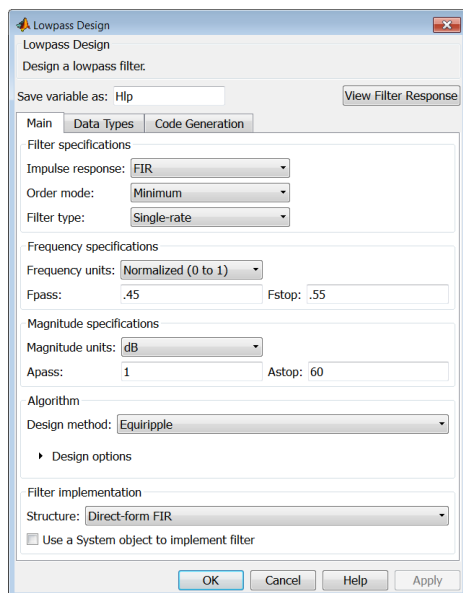

As you choose the response for the filter, the available options and design parameters displayed in the dialog box change. This display allows you to focus only on parameters that make sense in the context of your filter design.

Every filter design dialog box includes the options displayed at the top of the dialog box, shown in the following figure.



- **Save variable as** — When you click **Apply** to apply your changes or **OK** to close this dialog box, filterBuilder saves the current filter to your MATLAB workspace as a filter object with the name you enter.
- **View Filter Response** — Displays the magnitude response for the current filter specifications and design method by opening the Filter Visualization Tool (fvtool).

Note: The filterBuilder dialog box includes an **Apply** option. Each time you click **Apply**, filterBuilder writes the modified filter to your MATLAB workspace. This modified filter has the variable name you assign in **Save variable as**. To apply changes

without overwriting the variable in your workspace, change the variable name in **Save variable as** before you click **Apply**.

There are three tabs in the Filter Builder dialog box, containing three panes: **Main**, **Data Types**, and **Code Generation**. The first pane changes according to the filter being designed. The last two panes are the same for all filters. These panes are discussed in the following sections.

Data Types Pane

The second tab in the Filter Builder dialog box is shown in the following figure.

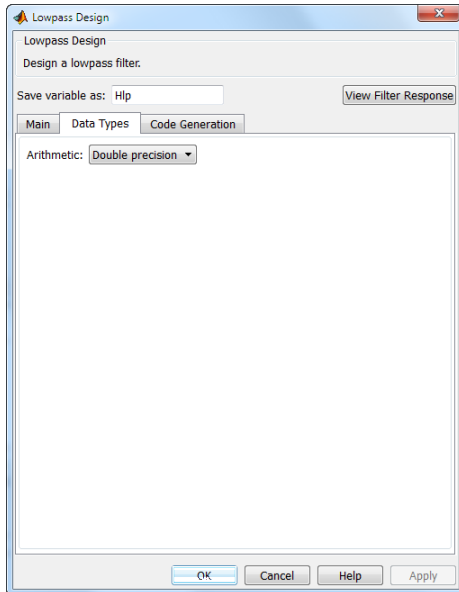

The **Arithmetic** drop down box allows the choice of **Double precision**, **Single precision**, or **Fixed point**. Some of these options may be unavailable depending on the filter parameters. The following table describes these options.

Arithmetic List Entry	Effect on the Filter
Double precision	All filtering operations and coefficients use double-precision, floating-point representations and math. When you use

Arithmetic List Entry	Effect on the Filter
	filterBuilder to create a filter, double precision is the default value for the Arithmetic property.
Single precision	All filtering operations and coefficients use single-precision floating-point representations and math.
Fixed point	This entry applies selected default values, typically used on many digital processors, for the properties in the fixed-point filter. These properties include coefficient word lengths, fraction lengths, and various operating modes. This setting allows signed fixed data types only. Fixed-point filter design with filterBuilder is available only when you install Fixed-Point Designer™ software along with DSP System Toolbox software.

The following figure shows the **Data Types** pane after you select **Fixed point** for **Arithmetic** and set **Filter internals** to **Specify precision**. This figure shows the **Data Types** pane for the case where the **Use a System object to implement filter** check box is not selected in the **Main** pane.

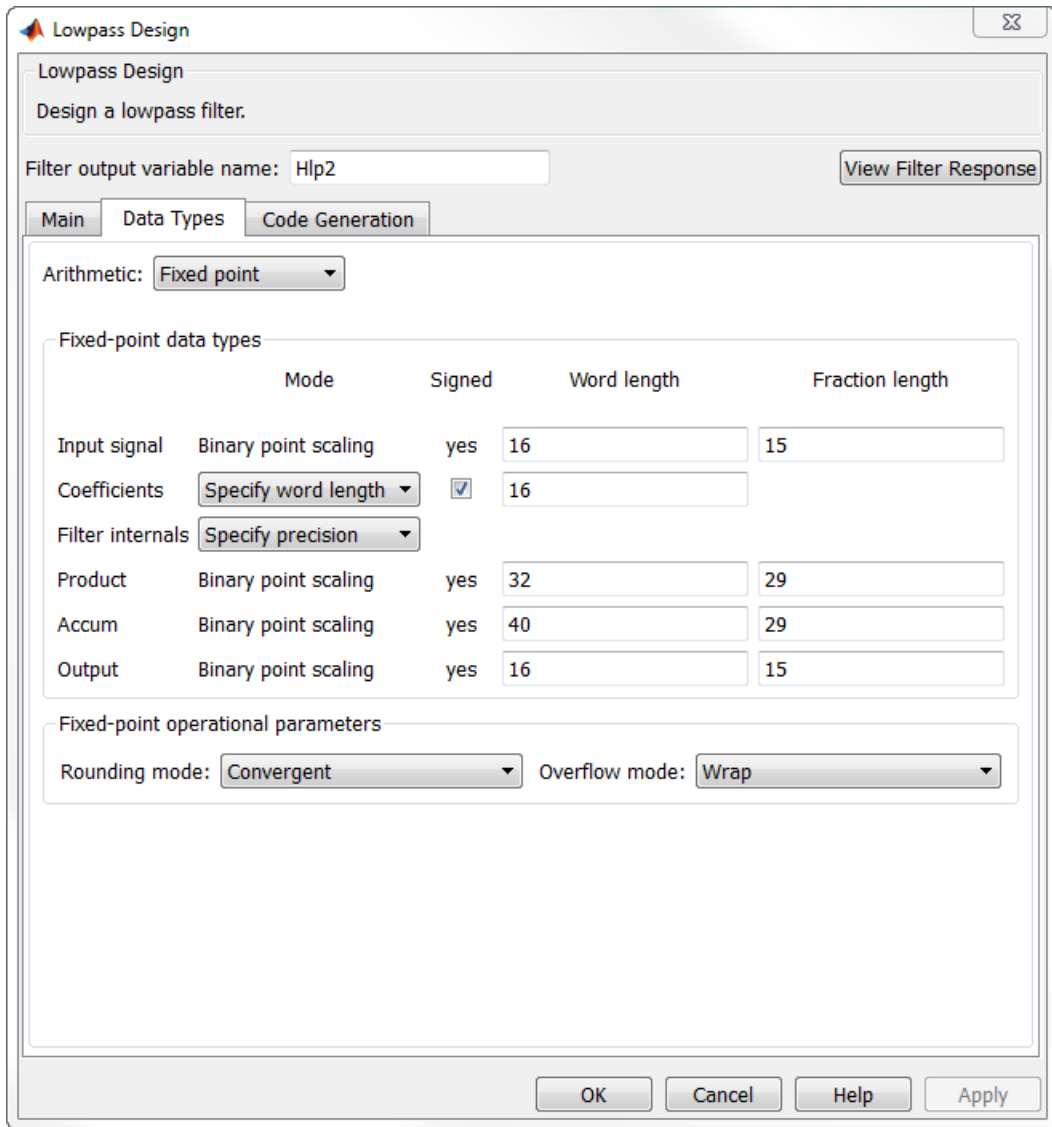

When you select **Use a System object to implement filter** check box in the **Main** pane, the **Data Types** pane appears as below:

Lowpass Design

Design a lowpass filter.

Filter output variable name:

Main | Data Types | Code Generation

Arithmetic:

Fixed-point data types

	Mode	Signed	Word length	Fraction length
Input signal	Binary point scaling	yes	<input type="text" value="16"/>	<input type="text" value="15"/>
Coefficients	<input type="text" value="Specify word length"/>	<input checked="" type="checkbox"/>	<input type="text" value="16"/>	
Filter internals	<input type="text" value="Specify precision"/>			
Product	<input type="text" value="Full precision"/>			
Accum	<input type="text" value="Full precision"/>			
Output	<input type="text" value="Same as accumulator"/>			

Not all parameters described in the following section apply to all filters. For example, FIR filters do not have the **Section input** and **Section output** parameters.

Input signal

Specify the format the filter applies to data to be filtered. For all cases, `filterBuilder` implements filters that use binary point scaling and signed input. You set the word length and fraction length as needed.

Coefficients

Choose how you specify the word length and the fraction length of the filter numerator and denominator coefficients:

- **Specify word length** enables you to enter the word length of the coefficients in bits. In this mode, `filterBuilder` automatically sets the fraction length of the coefficients to the binary-point only scaling that provides the best possible precision for the value and word length of the coefficients.
- **Binary point scaling** enables you to enter the word length and the fraction length of the coefficients in bits. If applicable, enter separate fraction lengths for the numerator and denominator coefficients.
- The filter coefficients do not obey the **Rounding mode** and **Overflow mode** parameters that are available when you select **Specify precision** from the Filter internals list. Coefficients are always saturated and rounded to **Nearest**.

Section Input

Choose how you specify the word length and the fraction length of the fixed-point data type going into each section of an SOS filter. This parameter is visible only when the selected filter structure is IIR and SOS.

- **Binary point scaling** enables you to enter the word and fraction lengths of the section input in bits.
- **Specify word length** enables you to enter the word lengths in bits.

Section Output

Choose how you specify the word length and the fraction length of the fixed-point data type coming out of each section of an SOS filter. This parameter is visible only when the selected filter structure is IIR and SOS.

- **Binary point scaling** enables you to enter the word and fraction lengths of the section output in bits.
- **Specify word length** enables you to enter the output word lengths in bits.

State

Contains the filter states before, during, and after filter operations. States act as filter memory between filtering runs or sessions. Use this parameter to specify how to designate the state word and fraction lengths. This parameter is not visible for direct form and direct form I filter structures because `filterBuilder` deduces the state directly from the input format. States always use signed representation:

- **Binary point scaling** enables you to enter the word length and the fraction length of the accumulator in bits.
- **Specify precision** enables you to enter the word length and fraction length in bits (if available).

Product

Determines how the filter handles the output of product operations. Choose from the following options:

- **Full precision** — Maintain full precision in the result.
- **Keep LSB** — Keep the least significant bit in the result when you need to shorten the data words.
- **Specify Precision** — Enables you to set the precision (the fraction length) used by the output from the multiplies.

Filter internals

Specify how the fixed-point filter performs arithmetic operations within the filter. The affected filter portions are filter products, sums, states, and output. Select one of these options:

- **Full precision** — Specifies that the filter maintains full precision in all calculations for products, output, and in the accumulator.
- **Specify precision** — Set the word and fraction lengths applied to the results of product operations, the filter output, and the accumulator. Selecting this option enables the word and fraction length controls.

Signed

Selecting this option directs the filter to use signed representations for the filter coefficients.

Word length

Sets the word length for the associated filter parameter in bits.

Fraction length

Sets the fraction length for the associate filter parameter in bits.

Accum

Use this parameter to specify how you would like to designate the accumulator word and fraction lengths.

Determines how the accumulator outputs stored values. Choose from the following options:

- **Full precision** — Maintain full precision in the accumulator.
- **Keep MSB** — Keep the most significant bit in the accumulator.
- **Keep LSB** — Keep the least significant bit in the accumulator when you need to shorten the data words.
- **Specify Precision** — Enables you to set the precision (the fraction length) used by the accumulator.

Output

Sets the mode the filter uses to scale the output data after filtering. You have the following choices:

- **Avoid Overflow** — Set the output data fraction length to avoid causing the data to overflow. **Avoid overflow** is considered the conservative setting because it is independent of the input data values and range.
- **Best Precision** — Set the output data fraction length to maximize the precision in the output data.
- **Specify Precision** — Set the fraction length used by the filtered data.

Fixed-point operational parameters

Parameters in this group control how the filter rounds fixed-point values and how it treats values that overflow.

Rounding mode

Sets the mode the filter uses to quantize numeric values when the values lie between representable values for the data format (word and fraction lengths).

- **ceil** — Round toward positive infinity.
- **convergent** — Round to the closest representable integer. Ties round to the nearest even stored integer. This is the least biased of the methods available in this software.

- `zero/fix` — Round toward zero.
- `floor` — Round toward negative infinity.
- `nearest` — Round toward nearest. Ties round toward positive infinity.
- `round` — Round toward nearest. Ties round toward negative infinity for negative numbers, and toward positive infinity for positive numbers.

The choice you make affects everything except coefficient values and input data which always round. In most cases, products do not overflow—they maintain full precision.

Overflow mode

Sets the mode the filter uses to respond to overflow conditions in fixed-point arithmetic. Choose from the following options:

- `Saturate` — Limit the output to the largest positive or negative representable value.
- `Wrap` — Set overflowing values to the nearest representable value using modular arithmetic.

The choice you make affects everything except coefficient values and input data which always round. In most cases, products do not overflow—they maintain full precision.

Cast before sum

Specifies whether to cast numeric data to the appropriate accumulator format before performing sum operations. Selecting **Cast before sum** ensures that the results of the affected sum operations match most closely the results found on most digital signal processors. Performing the cast operation before the summation adds one or two additional quantization operations that can add error sources to your filter results.

If you clear **Cast before sum**, the filter prevents the addends from being cast to the sum format before the addition operation. Choose this setting to get the most accurate results from summations without considering the hardware your filter might use. The input format referenced by **Cast before sum** depends on the filter structure you are using.

The effect of clearing or selecting **Cast before sum** is as follows:

- `Cleared` — Configures filter summation operations to retain the addends in the format carried from the previous operation.

- Selected — Configures filter summation operations to convert the input format of the addends to match the summation output format before performing the summation operation. Usually, selecting **Cast before sum** generates results from the summation that more closely match those found from digital signal processors.

Code Generation Pane

The code generation pane contains options for various implementations of the completed filter design. Depending on your installation, you can generate MATLAB, VHDL, and Verilog code from the designed filter. You can also choose to create or update a Simulink model from the designed filter. The following section explains these options.

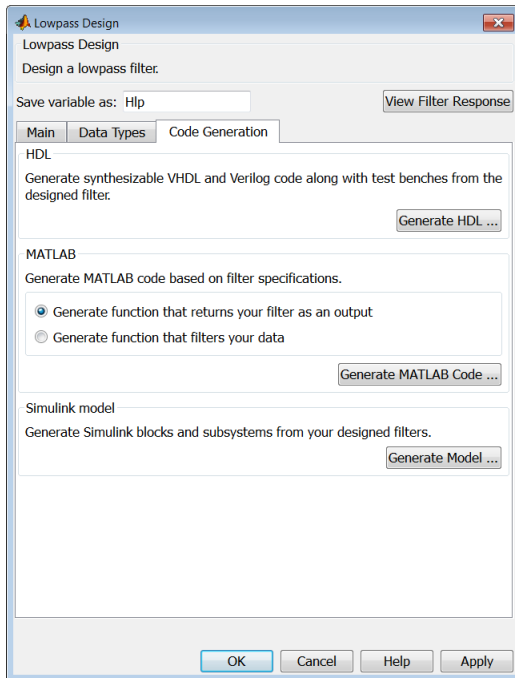

HDL

For more information on this option, see “Opening the Filter Design HDL Coder GUI from the Filter Builder” (Filter Design HDL Coder).

MATLAB

Generate MATLAB code based on filter specifications

- **Generate function that returns your filter as an output**

Selecting this option generates a function that designs a filter object using `fdesign`.

- **Generate function that filters your data**

Selecting this option generates a function that takes data as input, and outputs data filtered with the designed filter. The data type of the filter output is set according to the data type settings in the **Data Types** pane.

Clicking on the **Generate MATLAB code** button, brings up a Save File dialog. Specify the file name and location, and save. The filter is now contained in an editable file.

Simulink Model

Generate Simulink blocks and subsystems from your designed filters

When you click **Generate Model**, the filter builder generates Simulink blocks and subsystems from your designed filters.

Clicking on the **Generate Model** button opens the Export to Simulink dialog box.

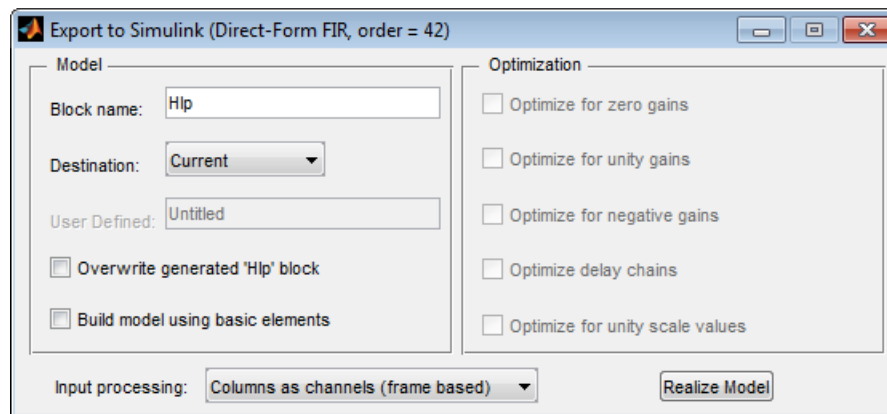

- **Block Name** — The name for the new subsystem block, set to **Filter** by default.
- **Destination** — **Current** saves the generated model to the current Simulink model. **New** creates a new model to contain the generated block. **User Defined** creates a new model or subsystem at the location specified in **User Defined**.

- **Overwrite generated 'Filter' block** — Overwrites an existing block with the name specified in **Block Name**. Clear this check box to create a new block with the same name.
- **Build model using basic elements** — Builds the model using only basic blocks.
- **Optimize for zero gains** — Removes all zero-gain blocks from the model.
- **Optimize for unity gains** — Replaces all unity gains with direct connections.
- **Optimize for negative gains** — Removes all negative unity gain blocks, and changes sign at the nearest summation block.
- **Optimize delay chains** — Replaces delay chains made up of n unit delays with a single delay by n .
- **Optimize for unity scale values** — Removes all scale value multiplications by 1 from the filter structure.
- **Input processing** — Specify how the generated filter block or subsystem block processes the input. Depending on the type of filter you are designing, one or both of the following options may be available:
 - **Columns as channels (frame based)** — The block treats each column of the input as a separate channel.
 - **Elements as channels (sample based)** — The block treats each element of the input as a separate channel.

For more information about sample-based and frame-based processing, see “Sample- and Frame-Based Concepts” (DSP System Toolbox).

- **Realize Model** — Builds the model with the set parameters.

When the **Use a System object to implement filter** check box is selected in the **Main** pane, the **Generate Model** button in the **Simulink model** panel is disabled under the following conditions:

- Select **Filter response** as **Comb** and **Arithmetic** on the **Data Types** pane as **Fixed point**.
- Select **Filter response** as **Arbitrary Response**, **Impulse response** as **IIR**, set **Specify response as** to either **Magnitudes and phases** or **Frequency response**, and **Arithmetic** on the **Data Types** pane as **Fixed point**.

These settings design a `dsp.IIRFilter` System object™ with fixed point arithmetic. Generating a Simulink model for fixed point `dsp.IIRFilter` object is not supported.

Filter Responses

Select your filter response from the **filterBuilder Response Selection** main menu.

If you have the DSP System Toolbox software, the following **Response Selection** menu appears.

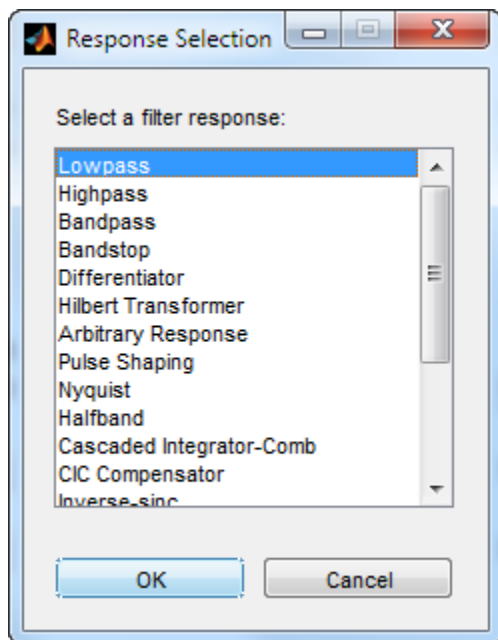

Select your desired filter response from the menu and design your filter.

The following sections describe the options available for each response type.

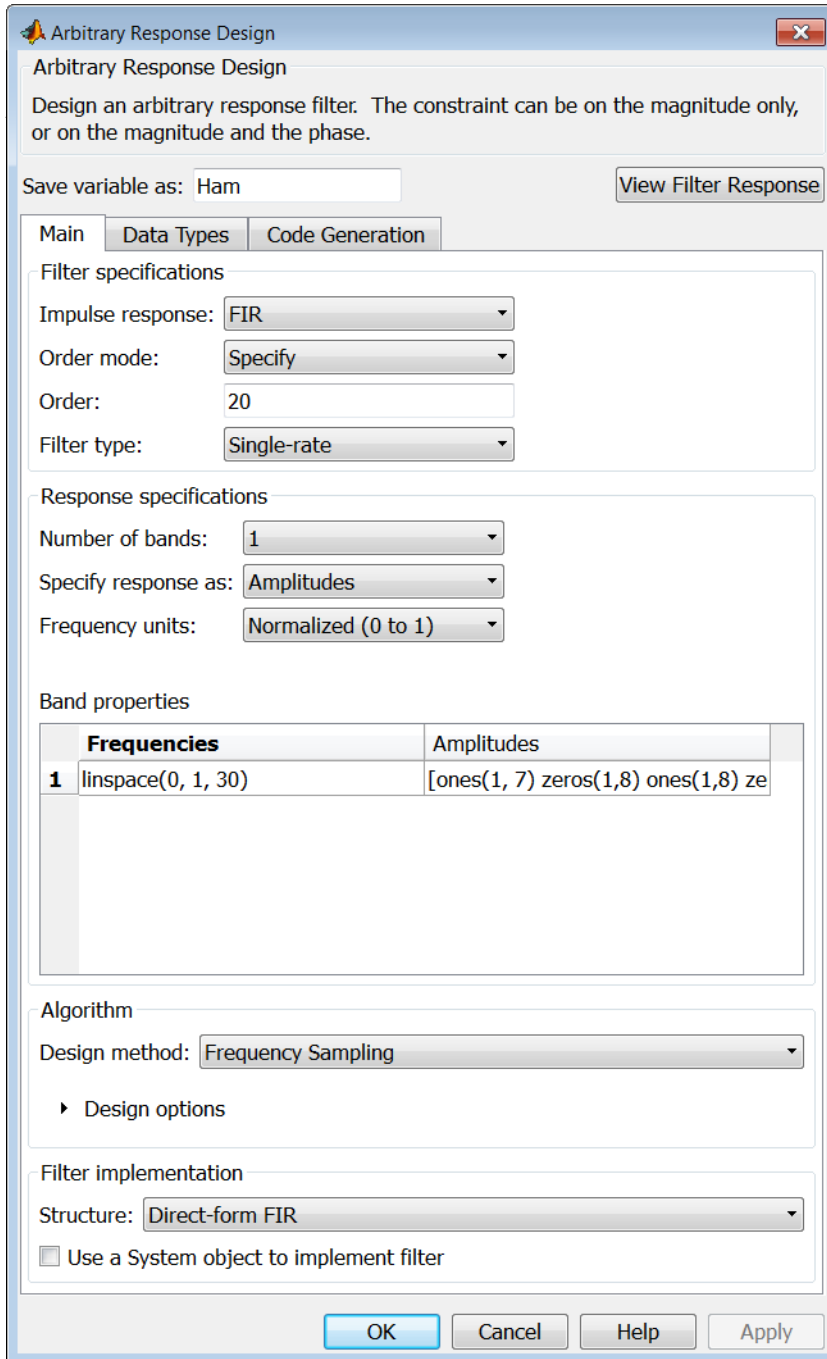

Filter specifications

Parameters in this group enable you to specify your filter format, such as the impulse response and the filter order.

Impulse response

This dialog only applies if you have the DSP System Toolbox software. Select either **FIR** or **IIR** from the drop down list, where **FIR** is the default impulse response. When you choose an impulse response, the design methods and structures you can use to implement your filter change accordingly. Arbitrary group delay designs are only available if **Impulse response** is **IIR**. Without the DSP System Toolbox, the only available arbitrary response filter design is **FIR**.

Order mode

This dialog only applies if you have the DSP System Toolbox software. Choose **Minimum** or **Specify**. Choosing **Specify** enables the **Order** dialog.

Order

This dialog only applies when **Order mode** is **Specify**. For an **FIR** design, specify the filter order. For an **IIR** design, you can specify an equal order for the numerator and denominator, or you can specify different numerator and denominator orders. The default is equal orders. To specify a different denominator order, check the **Denominator order** box. Because the Signal Processing Toolbox only supports **FIR** arbitrary-magnitude filters, you do not have the option to specify a denominator order.

Denominator order

Select the check box and enter the denominator order. This option is enabled only if **IIR** is selected for **Impulse response**.

Filter type

This dialog only applies if you have the DSP System Toolbox software and is only available for **FIR** filters. Select **Single-rate**, **Decimator**, **Interpolator**, or **Sample-rate converter**. Your choice determines the type of filter as well as the design methods and structures that are available to implement your filter. By default, **filterBuilder** specifies single-rate filters.

- Selecting **Decimator** or **Interpolator** activates the **Decimation Factor** or the **Interpolation Factor** options respectively.
- Selecting **Sample-rate converter** activates both factors.

When you design either a decimator or interpolator, the resulting filter is a bandpass filter that either decimates or interpolates your input signal.

Decimation Factor

Enter the decimation factor. This option is enabled only if the **Filter type** is set to **Decimator** or **Sample-rate converter**. The default factor value is 2 for **Decimator** and 3 for **Sample-rate converter**.

Interpolation Factor

Enter the decimation factor. This option is enabled only if the **Filter type** is set to **Interpolator** or **Sample-rate converter**. The default factor value is 2.

Response Specification

Number of Bands

Select the number of bands in the filter. Multiband design is available for both FIR and IIR filters.

Specify response as:

Specify the response as **Amplitudes**, **Magnitudes and phase**, **Frequency response**, or **Group delay**. **Amplitudes** is the only option if you do not have the DSP System Toolbox software. **Group delay** is only available for IIR designs.

Frequency units

Specify frequency units as either **Normalized**, **Hz**, **kHz**, **MHz**, or **GHz**.

Input Fs

Enter the input sampling frequency in the units specified in the **Frequency units** drop-down box. This option is enabled when **Frequency units** is set to an option in hertz.

Band Properties

These properties are modified automatically depending on the response chosen in the **Specify response as** drop-down box. Two or three columns are presented for input. The first column is always **Frequencies**. The other columns are either **Amplitudes**, **Magnitudes**, **Phases**, or **Frequency Response**. Enter the corresponding vectors of values for each column.

- **Frequencies** and **Amplitudes** — These columns are presented for input if you select **Amplitudes** in the **Specify response as** drop-down box.

- **Frequencies, Magnitudes, and Phases** — These columns are presented for input if the response chosen in the **Specify response as** drop-down box is **Magnitudes and phases**.
- **Frequencies and Frequency response** — These columns are presented for input if the response chosen in the **Specify response as** drop-down box is **Frequency response**.

Algorithm

The options for each design are specific for each design method. In the arbitrary response design, the available options also depend on the **Response specifications**. This section does not present all of the available options for all designs and design methods.

Design Method

Select the design method for the filter. Different methods are enabled depending on the defining parameters entered in the previous sections.

Design Options

- **Window** — Valid when the **Design method** is **Frequency Sampling**. Replace the square brackets with the name of a **window** function or function handle. For example, `'hamming'` or `@hamming`. If the window function takes parameters other than the length, use a cell array. For example, `{'kaiser', 3.5}` or `{@chebwin, 60}`.
- **Density factor** — Valid when the **Design method** is **equiripple**. Density factor controls the density of the frequency grid over which the design method optimization evaluates your filter response function. The number of equally spaced points in the grid is the value you enter for **Density factor** times (filter order + 1).

Increasing the value creates a filter that more closely approximates an ideal equiripple filter but increases the time required to design the filter. The default value of 16 represents a reasonable trade between the accurate approximation to the ideal filter and the time to design the filter.

The default changes to 20 for an IIR arbitrary group delay design.

- **Phase constraint** — Valid when the **Design method** is **equiripple**, you have the DSP System Toolbox installed, and **Specify response as** is set to **Amplitudes**. Choose one of **Linear**, **Minimum**, or **Maximum**.
- **Weights** — Uses the weights in **Weights** to weight the error for a single-band design. If you have multiple frequency bands, the **Weights** design option changes

to **B1 Weights**, **B2 Weights** to designate the separate bands. Use **Bi Weights** to specify weights for the *i*-th band. The **Bi Weights** design option is only available when you specify the *i*-th band as an unconstrained.

- **Bi forced frequency point** — This option is only available in a multi-band constrained equiripple design when **Specify response as** is **Amplitudes**. **Bi forced frequency point** is the frequency point in the *i*-th band at which the response is forced to be zero. The index **i** corresponds to the frequency bands in **Band properties**. For example, if you specify two bands in **Band properties**, you have **B1 forced frequency point** and **B2 forced frequency point**.
- **Norm** — Valid only for IIR arbitrary group delay designs. **Norm** is the norm used in the optimization. The default value is 128, which essentially equals the L-infinity norm. The norm must be even.
- **Max pole radius** — Valid only for IIR arbitrary group delay designs. Constrains the maximum pole radius. The default is 0.999999. Reducing the **Max pole radius** can produce a transfer function more resistant to quantization.
- **Init norm** — Valid only for IIR arbitrary group delay designs. The initial norm used in the optimization. The default initial norm is 2.
- **Init numerator** — Specifies an initial estimate of the filter numerator coefficients.
- **Init denominator** — Specifies an initial estimate of the filter denominator coefficients. This may be useful in difficult optimization problems. In allpass filters, you only have to specify either the denominator or numerator coefficients. If you specify the denominator coefficients, you can obtain the numerator coefficients.

Filter implementation

Structure

Select the structure for the filter. The available filter structures depend on the parameters you select for your filter.

Use a System object to implement filter

This check box appears when you set **Filter type** to **Single-rate**. Selecting this check box gives you the choice of using a System object to implement the filter. By default, this check box is cleared.

This check box no longer appears when you set **Filter type** to **Interpolator**, **Decimator**, or **Sample-rate converter**. The filter builder always implements the filter as a System object.

Audio Weighting Filter Design — Main Pane

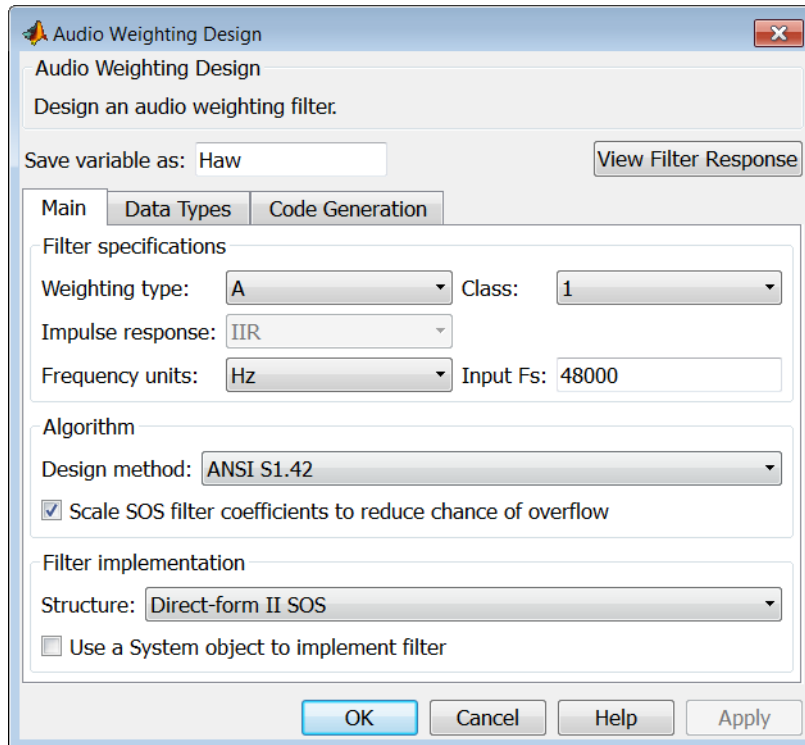

Filter specifications

- **Weighting type** — The weighting type defines the frequency response of the filter. The valid weighting types are: A, C, C-message, ITU-T 0.41, and ITU-R 468–4 weighting. See `fdesign.audioweighting` for definitions of the weighting types.
- **Class** — Filter class is only applicable for A weighting and C weighting filters. The filter class describes the frequency-dependent tolerances specified in the relevant standards. There are two possible class values: 1 and 2. Class 1 weighting filters have stricter tolerances than class 2 filters. The filter class value does not affect the design. The class value is only used to provide a specification mask in `fvtool` for the analysis of the filter design.

- **Impulse response** — Impulse response type as one of **IIR** or **FIR**. For **A**, **C**, **C-message**, and **ITU-R 468–4 filter**, **IIR** is the only option. For a **ITU-T 0.41 weighting filter**, **FIR** is the only option.
- **Frequency units** — Choose **Hz**, **kHz**, **MHz**, or **GHz**. Normalized frequency designs are not supported for audio weighting filters.
- **Input Fs** — The sampling frequency in **Frequency units**. For example, if **Frequency units** is set to **kHz**, setting **Input Fs** to **40** is equivalent to a **40 kHz** sampling frequency.

Algorithm

- **Design method** — Valid design methods depend on the weighting type. For type **A** and **C** weighting filters, the only valid design type is **ANSI S1.42**. This is an **IIR** design method that follows ANSI standard **S1.42–2001**. For a **C message filter**, the only valid design method is **Bell 41009**, which is an **IIR** design method following the Bell System Technical Reference **PUB 41009**. For a **ITU-R 468–4 weighting filter**, you can design an **IIR** or **FIR** filter. If you choose an **IIR** design, the design method is **IIR least p-norm**. If you choose an **FIR** design, the design method choices are: **Equiripple** or **Frequency Sampling**. For an **ITU-T 0.41 weighting filter**, the available **FIR** design methods are **Equiripple** or **Frequency Sampling**.
- **Scale SOS filter coefficients to reduce chance of overflow** — Selecting this parameter directs the design to scale the filter coefficients to reduce the chances that the inputs or calculations in the filter overflow and exceed the representable range of the filter. Clearing this option removes the scaling. This parameter applies only to **IIR** filters.

Filter implementation

- **Structure** — For the filter specifications and design method you select, this parameter lists the filter structures available to implement your filter. For audio weighting **IIR** filter designs, you can choose **direct form I** or **II biquad (SOS)**. You can also choose to implement these structures in **transposed form**.

For **FIR** designs, you can choose **direct form**, **direct-form transposed**, **direct-form symmetric**, **direct-form asymmetric** structures, or an **overlap and add** structure.

- **Use a System object to implement filter** — Selecting this check box gives you the choice of using a **System** object to implement the filter. By default, this check box is cleared. When the current design method or structure is not supported by a **System** object filter, then this check box is disabled.

Bandpass Design

Design a bandpass filter.

Save variable as:

Main

Filter specifications

Impulse response:

Order mode:

Filter type:

Frequency specifications

Frequency units:

Fstop1: Fpass1:

Fpass2: Fstop2:

Magnitude specifications

Magnitude units:

Astop1: Apass:

Astop2:

Algorithm

Design method:

Design options

Density factor:

Phase constraint:

Minimum order:

Uniform grid

Filter implementation

Structure:

Use a System object to implement filter

Filter specifications

Parameters in this group enable you to specify your filter format, such as the impulse response and the filter order.

Impulse response

Select **FIR** or **IIR** from the drop-down list, where **FIR** is the default impulse response. When you choose an impulse response, the design methods and structures you can use to implement your filter change accordingly.

Note: The design methods and structures for FIR filters are not the same as the methods and structures for IIR filters.

Order mode

Select **Minimum** (the default) or **Specify** from the drop-down box. Selecting **Specify** enables the **Order** option so you can enter the filter order.

If you have the DSP System Toolbox software installed, you can specify IIR filters with different numerator and denominator orders. The default is equal orders. To specify a different denominator order, check the **Denominator order** box.

Filter type — This dialog only applies if you have the DSP System Toolbox software.

Select **Single-rate**, **Decimator**, **Interpolator**, or **Sample-rate converter**. Your choice determines the type of filter as well as the design methods and structures that are available to implement your filter. By default, `filterBuilder` specifies single-rate filters.

- Selecting **Decimator** or **Interpolator** activates the **Decimation Factor** or the **Interpolation Factor** options respectively.
- Selecting **Sample-rate converter** activates both factors.

Order

Enter the filter order. This option is enabled only if you select **Specify** for **Order mode**.

Decimation Factor

Enter the decimation factor. This option is enabled only if the **Filter type** is set to **Decimator** or **Sample-rate converter**. The default factor value is 2.

Interpolation Factor

Enter the decimation factor. This option is enabled only if the **Filter type** is set to Interpolator or Sample-rate converter. The default factor value is 2.

Frequency specifications

The parameters in this group allow you to specify your filter response curve. Graphically, the filter specifications look similar to those shown in the following figure.

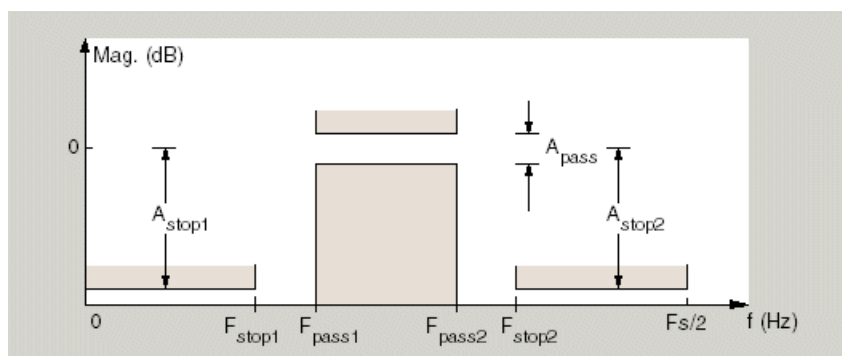

In the figure, regions between specification values such as F_{stop1} and F_{pass1} represent transition regions where the filter response is not explicitly defined.

Frequency constraints

Select the filter features to use to define the frequency response characteristics. This dialog applies only when **Order mode** is **Specify**.

- **Passband and stopband edges** — Define the filter by specifying the frequencies for the edges for the stop- and passbands.
- **Passband edges** — Define the filter by specifying frequencies for the edges of the passband.
- **Stopband edges** — Define the filter by specifying frequencies for the edges of the stopbands.
- **3dB points** — Define the filter response by specifying the locations of the 3 dB points (IIR filters). The 3-dB point is the frequency for the point 3 dB below the passband value.
- **3dB points and passband width** — Define the filter by specifying frequencies for the 3-dB points in the filter response and the width of the passband. (IIR filters)

- **3dB points and stopband widths** — Define the filter by specifying frequencies for the 3-dB points in the filter response and the width of the stopband. (IIR filters)
- **6dB points** — Define the filter response by specifying the locations of the 6-dB points. The 6-dB point is the frequency for the point 6 dB below the passband value. (FIR filters)

Frequency units

Use this parameter to specify whether your frequency settings are normalized or in absolute frequency. Select **Normalized (0–1)** to enter frequencies in normalized form. This behavior is the default. To enter frequencies in hertz, select one of the frequency units from the drop-down list—HZ, KHZ, MHZ, or GHZ. Selecting one of the unit options enables the **Input Fs** parameter.

Input Fs

Fs, specified in the units you selected for **Frequency units**, defines the sampling frequency at the filter input. When you provide an input sampling frequency, all frequencies in the specifications are in the selected units as well. This parameter is available when you select one of the frequency options from the **Frequency units** list.

Fstop1

Enter the frequency at the edge of the end of the first stopband. Specify the value in either normalized frequency units or the absolute units you select in **Frequency units**.

Fpass1

Enter the frequency at the edge of the start of the passband. Specify the value in either normalized frequency units or the absolute units you select **Frequency units**.

Fpass2

Enter the frequency at the edge of the end of the passband. Specify the value in either normalized frequency units or the absolute units you select **Frequency units**.

Fstop2

Enter the frequency at the edge of the start of the second stopband. Specify the value in either normalized frequency units or the absolute units you select **Frequency units**.

Magnitude specifications

The parameters in this group let you specify the filter response in the passbands and stopbands.

Magnitude constraints

Specify as **Unconstrained** or **Constrained** bands. You must have the DSP System Toolbox software to select **Constrained** bands. Selecting **Constrained** bands enables dialogs for both stopbands and the passband: **Astop1**, **Astop2**, and **Apass**. You cannot specify constraints for all three bands simultaneously.

Setting **Magnitude constraints** to **Constrained** bands enables the **Wstop** and **Wpass** options under **Design options**.

Magnitude units

Specify the units for any parameter you provide in magnitude specifications. Select one of the following options from the drop-down list.

- **Linear** — Specify the magnitude in linear units.
- **dB** — Specify the magnitude in dB (decibels). This is the default setting.
- **Squared** — Specify the magnitude in squared units.

Astop1

Enter the filter attenuation in the first stopband in the units you choose for **Magnitude units**, either linear or decibels.

Apass

Enter the filter ripple allowed in the passband in the units you choose for **Magnitude units**, either linear or decibels.

Astop2

Enter the filter attenuation in the second stopband in the units you choose for **Magnitude units**, either linear or decibels.

Algorithm

The parameters in this group allow you to specify the design method and structure that **filterBuilder** uses to implement your filter.

Design Method

Lists the design methods available for the frequency and magnitude specifications you entered. When you change the specifications for a filter, such as changing the impulse response, the methods available to design filters changes as well. The default IIR design method is usually Butterworth, and the default FIR method is equiripple.

Scale SOS filter coefficients to reduce chance of overflow

Selecting this parameter directs the design to scale the filter coefficients to reduce the chances that the inputs or calculations in the filter overflow and exceed the representable range of the filter. Clearing this option removes the scaling. This parameter applies only to IIR filters.

Design Options

The options for each design are specific for each design method. This section does not present all of the available options for all designs and design methods. There are many more that you encounter as you select different design methods and filter specifications. The following options represent some of the most common ones available.

Density factor

Density factor controls the density of the frequency grid over which the design method optimization evaluates your filter response function. The number of equally spaced points in the grid is the value you enter for **Density factor** times (filter order + 1).

Increasing the value creates a filter that more closely approximates an ideal equiripple filter but increases the time required to design the filter. The default value of 16 represents a reasonable trade between the accurate approximation to the ideal filter and the time to design the filter.

Phase constraint

Valid when the **Design method** is equiripple and you have the DSP System Toolbox installed. Choose one of **Linear**, **Minimum**, or **Maximum**.

Minimum order

This option only applies when you have the DSP System Toolbox software and **Order mode** is **Minimum**.

Select **Any** (default), **Even**, or **Odd**. Selecting **Even** or **Odd** forces the minimum-order design to be an even or odd order.

Wstop1

Weight for the first stopband.

Wpass

Passband weight.

Wstop2

Weight for the second stopband.

Max pole radius

Valid only for IIR designs. Constrains the maximum pole radius. The default is 1. Reducing the max pole radius can produce a transfer function more resistant to quantization.

Init norm

Valid only for IIR designs. The initial norm used in the optimization. The default initial norm is 2.

Init numerator

Specifies an initial estimate of the filter numerator coefficients. This may be useful in difficult optimization problems.

Init denominator

Specifies an initial estimate of the filter denominator coefficients. This may be useful in difficult optimization problems.

Filter implementation**Structure**

For the filter specifications and design method you select, this parameter lists the filter structures available to implement your filter. By default, FIR filters use direct-form structure, and IIR filters use direct-form II filters with SOS.

Use a System object to implement filter

This check box appears when you set **Filter type** to **Single-rate**. Selecting this check box gives you the choice of using a System object to implement the filter. By default, this check box is cleared.

This check box no longer appears when you set **Filter type** to **Interpolator**, **Decimator**, or **Sample-rate converter**. The filter builder always implements the filter as a System object.

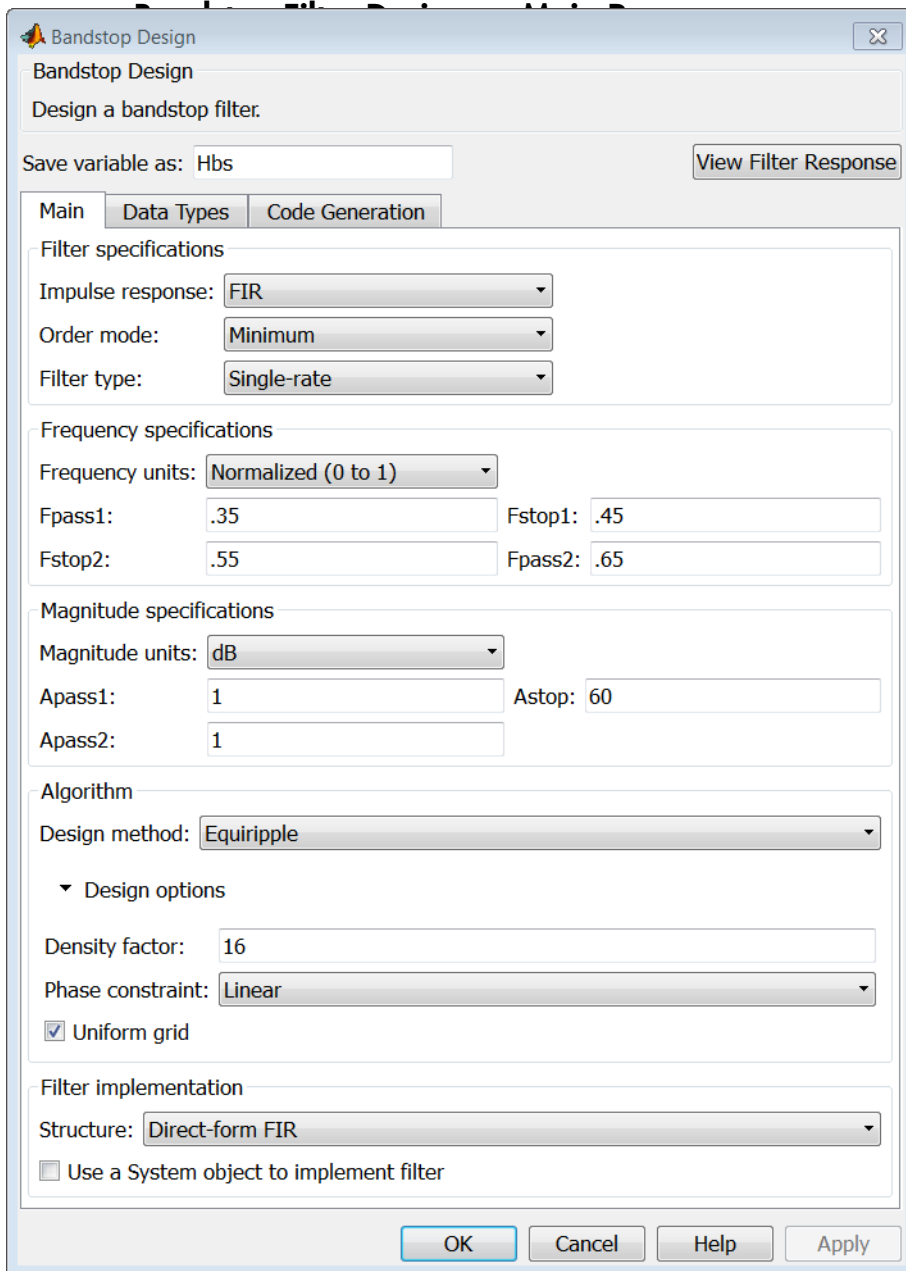

Filter specifications

Parameters in this group enable you to specify your filter format, such as the impulse response and the filter order.

Impulse response

Select **FIR** or **IIR** from the drop-down list, where **FIR** is the default impulse response. When you choose an impulse response, the design methods and structures you can use to implement your filter change accordingly.

Note: The design methods and structures for FIR filters are not the same as the methods and structures for IIR filters.

Order mode

Select **Minimum** (the default) or **Specify** from the drop-down list. Selecting **Specify** enables the **Order** option so you can enter the filter order.

If you have the DSP System Toolbox software installed, you can specify IIR filters with different numerator and denominator orders. The default is equal orders. To specify a different denominator order, check the **Denominator order** box.

Filter type

Select **Single-rate**, **Decimator**, **Interpolator**, or **Sample-rate converter**. Your choice determines the type of filter as well as the design methods and structures that are available to implement your filter. By default, **filterBuilder** specifies single-rate filters.

- Selecting **Decimator** or **Interpolator** activates the **Decimation Factor** or the **Interpolation Factor** options respectively.
- Selecting **Sample-rate converter** activates both factors.

When you design either a decimator or an interpolator, the resulting filter is a bandpass filter that either decimates or interpolates your input signal.

Order

Enter the filter order. This option is enabled only if **Specify** was selected for **Order mode**.

Decimation Factor

Enter the decimation factor. This option is enabled only if the **Filter type** is set to Decimator or Sample-rate converter. The default factor value is 2.

Interpolation Factor

Enter the decimation factor. This option is enabled only if the **Filter type** is set to Interpolator or Sample-rate converter. The default factor value is 2.

Frequency specifications

The parameters in this group allow you to specify your filter response curve. Graphically, the filter specifications look similar to those shown in the following figure.

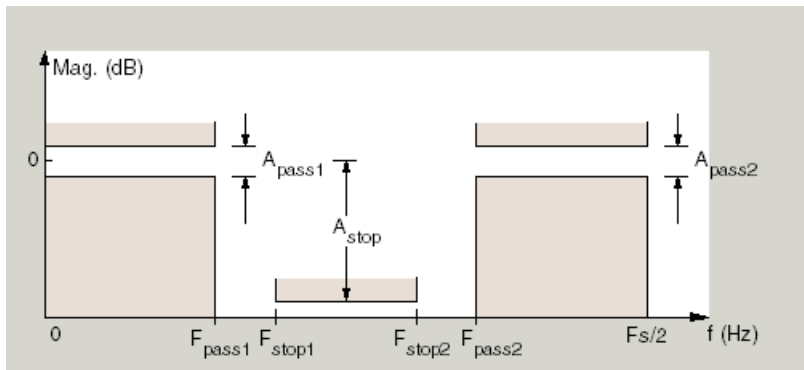

Frequency constraints

Select the filter features to use to define the frequency response characteristics. This dialog applies only when **Order mode** is **Specify**.

- **Passband and stopband edges** — Define the filter by specifying the frequencies for the edges for the stop- and passbands.
- **Passband edges** — Define the filter by specifying frequencies for the edges of the passband.
- **Stopband edges** — Define the filter by specifying frequencies for the edges of the stopbands.
- **3dB points** — Define the filter response by specifying the locations of the 3 dB points (IIR filters). The 3 dB point is the frequency for the point 3 dB below the passband value.

- **3dB points and passband width** — Define the filter by specifying frequencies for the 3 dB points in the filter response and the width of the passband (IIR filters).
- **3dB points and stopband widths** — Define the filter by specifying frequencies for the 3 dB points in the filter response and the width of the stopband (IIR filters).
- **6dB points** — Define the filter response by specifying the locations of the 6-dB points (FIR filters). The 6-dB point is the frequency for the point 6 dB below the passband value.

Frequency units

Use this parameter to specify whether your frequency settings are normalized or in absolute frequency. Select **Normalized (0–1)** to enter frequencies in normalized form. This behavior is the default. To enter frequencies in absolute values, select one of the frequency units from the drop-down list—Hz, kHz, MHz, or GHz. Selecting one of the unit options enables the **Input Fs** parameter.

Input Fs

Fs, specified in the units you selected for **Frequency units**, defines the sampling frequency at the filter input. When you provide an input sampling frequency, all frequencies in the specifications are in the selected units as well. This parameter is available when you select one of the frequency options from the **Frequency units** list.

Output Fs

When you design an interpolator, Fs represents the sampling frequency at the filter output rather than the filter input. This option is available only when you set **Filter type** is interpolator.

Fpass1

Enter the frequency at the edge of the end of the first passband. Specify the value in either normalized frequency units or the absolute units you select in **Frequency units**.

Fstop1

Enter the frequency at the edge of the start of the stopband. Specify the value in either normalized frequency units or the absolute units you select **Frequency units**.

Fstop2

Enter the frequency at the edge of the end of the stopband. Specify the value in either normalized frequency units or the absolute units you select **Frequency units**.

Fpass2

Enter the frequency at the edge of the start of the second passband. Specify the value in either normalized frequency units or the absolute units you select **Frequency units**.

Magnitude specifications

The parameters in this group let you specify the filter response in the passbands and stopbands.

Magnitude constraints

Specify as **Unconstrained** or **Constrained** bands. You must have the DSP System Toolbox software to select **Constrained** bands. Selecting **Constrained** bands enables dialogs for both passbands and the stopband: **Apass1**, **Apass2**, and **Astop**. You cannot specify constraints for all three bands simultaneously.

Setting **Magnitude constraints** to **Constrained** bands enables the **Wstop** and **Wpass** options under **Design options**.

Magnitude units

Specify the units for any parameter you provide in magnitude specifications. Select one of the following options from the drop-down list.

- **Linear** — Specify the magnitude in linear units.
- **dB** — Specify the magnitude in decibels (default).
- **Squared** — Specify the magnitude in squared units.

Apass1

Enter the filter ripple allowed in the first passband in the units you choose for **Magnitude units**, either linear or decibels.

Astop

Enter the filter attenuation in the stopband in the units you choose for **Magnitude units**, either linear or decibels

Apass2

Enter the filter ripple allowed in the second passband in the units you choose for **Magnitude units**, either linear or decibels

Algorithm

The parameters in this group allow you to specify the design method and structure that `filterBuilder` uses to implement your filter.

Design Method

Lists the design methods available for the frequency and magnitude specifications you entered. When you change the specifications for a filter, such as changing the impulse response, the methods available to design filters changes as well. The default IIR design method is usually Butterworth, and the default FIR method is equiripple.

Scale SOS filter coefficients to reduce chance of overflow

Selecting this parameter directs the design to scale the filter coefficients to reduce the chances that the inputs or calculations in the filter overflow and exceed the representable range of the filter. Clearing this option removes the scaling. This parameter applies only to IIR filters.

Design Options

The options for each design are specific for each design method. This section does not present all of the available options for all designs and design methods. There are many more that you encounter as you select different design methods and filter specifications. The following options represent some of the most common ones available.

Density factor

Density factor controls the density of the frequency grid over which the design method optimization evaluates your filter response function. The number of equally spaced points in the grid is the value you enter for **Density factor** times (filter order + 1).

Increasing the value creates a filter that more closely approximates an ideal equiripple filter but increases the time required to design the filter. The default value of 16 represents a reasonable trade between the accurate approximation to the ideal filter and the time to design the filter.

Phase constraint

Valid when the **Design method** is equiripple and you have the DSP System Toolbox installed. Choose one of **Linear**, **Minimum**, or **Maximum**.

Minimum order

This option only applies when you have the DSP System Toolbox software and **Order mode** is **Minimum**.

Select **Any** (default), **Even**, or **Odd**. Selecting **Even** or **Odd** forces the minimum-order design to be an even or odd order.

Wpass1

Weight for the first passband.

Wstop

Stopband weight.

Wpass2

Weight for the second passband.

Match exactly

Specifies that the resulting filter design matches either the passband or stopband or both bands when you select **passband** or **stopband**.

Max pole radius

Valid only for IIR designs. Constrains the maximum pole radius. The default is 1. Reducing the max pole radius can produce a transfer function more resistant to quantization.

Init norm

Valid only for IIR designs. The initial norm used in the optimization. The default initial norm is 2.

Init numerator

Specifies an initial estimate of the filter numerator coefficients. This may be useful in difficult optimization problems.

Init denominator

Specifies an initial estimate of the filter denominator coefficients. This may be useful in difficult optimization problems.

Filter implementation

Structure

For the filter specifications and design method you select, this parameter lists the filter structures available to implement your filter. By default, FIR filters use direct-form structure, and IIR filters use direct-form II filters with SOS.

Use a System object to implement filter

This check box appears when you set **Filter type** to **Single-rate**. Selecting this check box gives you the choice of using a System object to implement the filter. By default, this check box is cleared.

This check box no longer appears when you set **Filter type** to **Interpolator**, **Decimator**, or **Sample-rate converter**. The filter builder always implements the filter as a System object.

CIC Filter Design — Main Pane

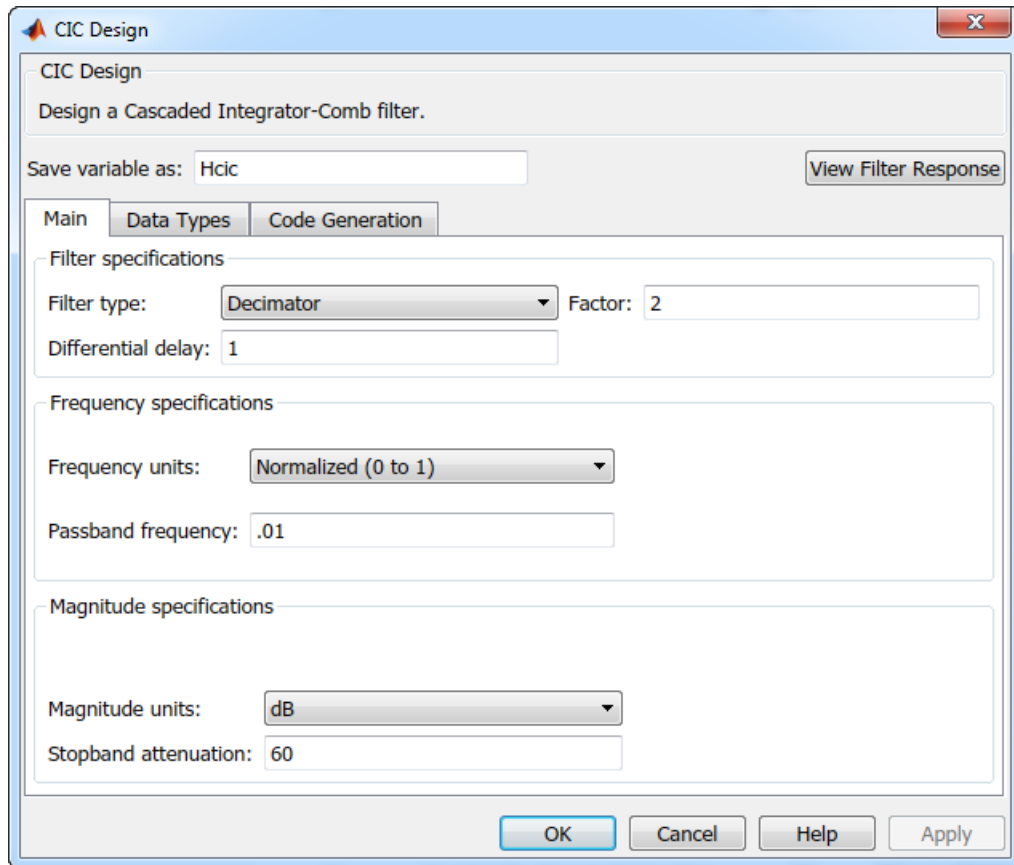

Filter specifications

Parameters in this group enable you to specify your CIC filter format, such as the filter type and the differential delay.

Filter type

Select whether your filter will be a **decimator** or an **interpolator**. Your choice determines the type of filter and the design methods and structures that are available to implement your filter. Selecting **decimator** or **interpolator** activates

the **Factor** option. When you design an interpolator, you enable the **Output Fs** parameter.

When you design either a decimator or interpolator, the resulting filter is a CIC filter that decimates or interpolates your input signal.

Differential Delay

Specify the differential delay of your CIC filter as an integer value greater than or equal to 1. The default value is 1. The differential delay changes the shape, number, and location of nulls in the filter response. Increasing the differential delay increases the sharpness of the nulls and the response between the nulls. In practice, differential delay values of 1 or 2 are the most common.

Factor

Specify the decimation or interpolation factor for your filter as an integer value greater than or equal to 1. The default value is 2.

Frequency specifications

Frequency units

Use this parameter to specify whether your frequency settings are normalized or in absolute frequency. Select **Normalized (0–1)** to enter frequencies in normalized form. This behavior is the default. To enter frequencies in absolute values, select one of the frequency units from the drop-down list—**Hz**, **KHz**, **MHz**, or **GHz**. Selecting one of the unit options enables the **Input Fs** parameter.

Input Fs

Fs, specified in the units you selected for **Frequency units**, defines the sampling frequency at the filter input. When you provide an input sampling frequency, all frequencies in the specifications are in the selected units as well. This parameter is available when you select one of the frequency options from the **Frequency units** list.

Output Fs

Fs, specified in the units you selected for **Frequency units**, defines the sampling frequency at the filter output. When you provide an output sampling frequency, all frequencies in the specifications are in the selected units as well. This parameter is available only when you design interpolators.

Fpass

Enter the frequency at the end of the passband. Specify the value in either normalized frequency units or the absolute units you select **Frequency units**.

Magnitude specifications

Magnitude units

Specify the units for any parameter you provide in magnitude specifications. Select one of the following options from the drop-down list.

- **Linear** — Specify the magnitude in linear units.
- **dB** — Specify the magnitude in decibels (default).
- **Squared** — Specify the magnitude in squared units.

Astop

Enter the filter attenuation in the stopband in the units you choose for **Magnitude units**, either linear or decibels.

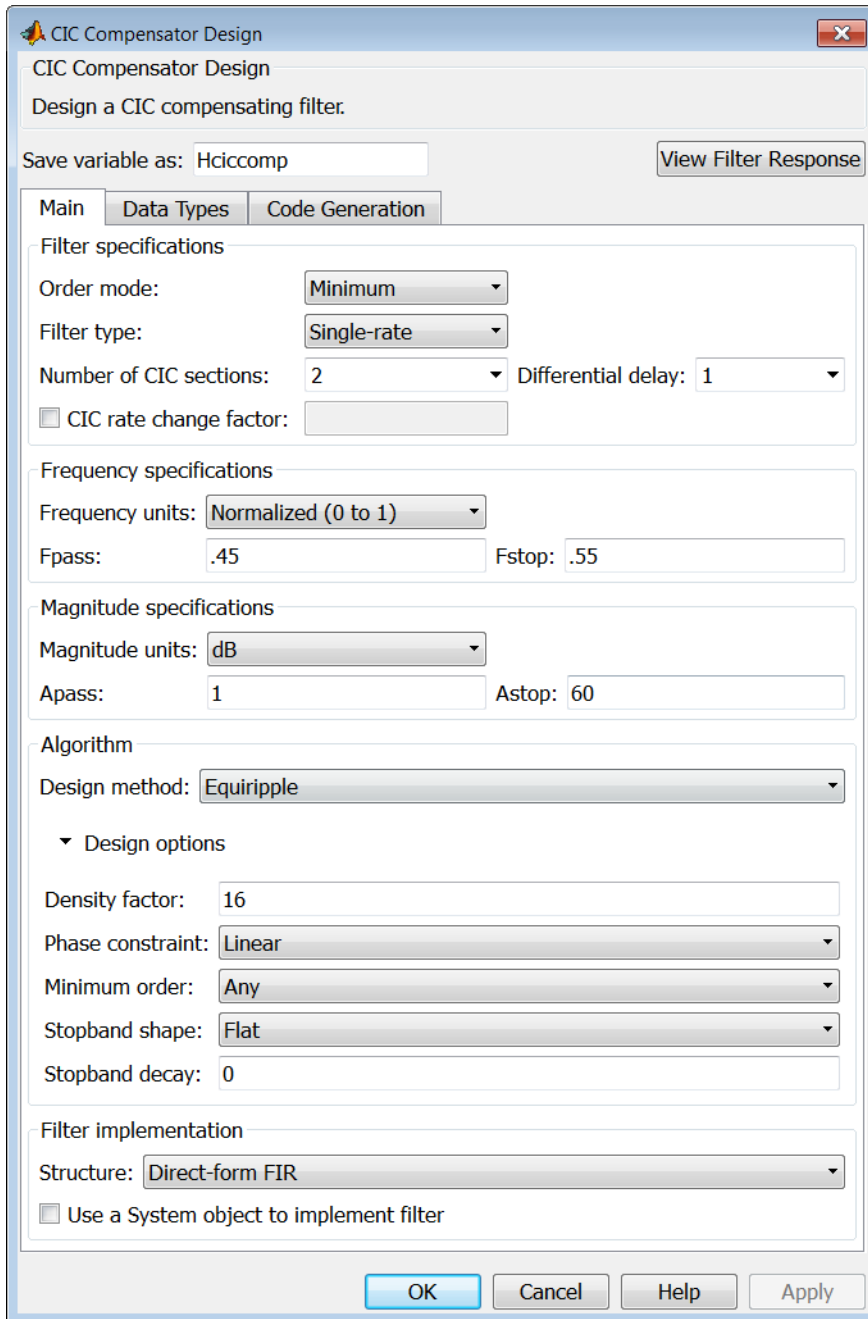

Filter specifications

Parameters in this group enable you to specify your filter format, such as the filter order mode and the filter type.

Order mode

Select **Minimum** (the default) or **Specify** from the drop-down list. Selecting **Specify** enables the **Order** option (see the following sections) so you can enter the filter order.

Filter type

Select **Single-rate**, **Decimator**, **Interpolator**, or **Sample-rate converter**. Your choice determines the type of filter as well as the design methods and structures that are available to implement your filter. By default, `filterBuilder` specifies single-rate filters.

- Selecting **Decimator** or **Interpolator** activates the **Decimation Factor** or the **Interpolation Factor** options respectively.
- Selecting **Sample-rate converter** activates both factors.

When you design either a decimator or an interpolator, the resulting filter is a bandpass filter that either decimates or interpolates your input signal.

Order

Enter the filter order. This option is enabled only if **Specify** was selected for **Order mode**.

Decimation Factor

Enter the decimation factor. This option is enabled only if the **Filter type** is set to **Decimator** or **Sample-rate converter**. The default factor value is 2.

Interpolation Factor

Enter the decimation factor. This option is enabled only if the **Filter type** is set to **Interpolator** or **Sample-rate converter**. The default factor value is 2.

Number of CIC sections

Specify the number of sections in the CIC filter for which you are designing this compensator. Select the number of sections from the drop-down list or enter the number.

Differential Delay

Specify the differential delay of your target CIC filter. The default value is 1. Most CIC filters use 1 or 2.

Frequency specifications

The parameters in this group allow you to specify your filter response curve.

Frequency specifications

Frequency units

Use this parameter to specify whether your frequency settings are normalized or in absolute frequency. Select **Normalized (0–1)** to enter frequencies in normalized form. This behavior is the default. To enter frequencies in absolute values, select one of the frequency units from the drop-down list—Hz, kHz, MHz, or GHz. Selecting one of the unit options enables the **Input Fs** parameter.

Input Fs

Fs, specified in the units you selected for **Frequency units**, defines the sampling frequency at the filter input. When you provide an input sampling frequency, all frequencies in the specifications are in the selected units as well. This parameter is available when you select one of the frequency options from the **Frequency units** list.

Output Fs

Fs, specified in the units you selected for **Frequency units**, defines the sampling frequency at the filter output. When you provide an output sampling frequency, all frequencies in the specifications are in the selected units as well. This parameter is available only when you design interpolators.

Fpass

Enter the frequency at the end of the passband. Specify the value in either normalized frequency units or the absolute units you select **Frequency units**.

Fstop

Enter the frequency at the start of the stopband. Specify the value in either normalized frequency units or the absolute units you select **Frequency units**.

Magnitude specifications

The parameters in this group let you specify the filter response in the passbands and stopbands.

Magnitude units

Specify the units for any parameter you provide in magnitude specifications. Select one of the following options from the drop-down list.

- **Linear** — Specify the magnitude in linear units.

- **dB** — Specify the magnitude in decibels (default).
- **Squared** — Specify the magnitude in squared units.

Apass

Enter the filter ripple allowed in the passband in the units you choose for **Magnitude units**, either linear or decibels

Algorithm

The parameters in this group allow you to specify the design method and structure that `filterBuilder` uses to implement your filter.

Design Method

Lists the design methods available for the frequency and magnitude specifications you entered. When you change the specifications for a filter, such as changing the impulse response, the methods available to design filters changes as well. The default IIR design method is usually Butterworth, and the default FIR method is equiripple.

Design Options

The options for each design are specific for each design method. This section does not present all of the available options for all designs and design methods. There are many more that you encounter as you select different design methods and filter specifications. The following options represent some of the most common ones available.

Density factor

Density factor controls the density of the frequency grid over which the design method optimization evaluates your filter response function. The number of equally spaced points in the grid is the value you enter for **Density factor** times (filter order + 1).

Increasing the value creates a filter that more closely approximates an ideal equiripple filter but increases the time required to design the filter. The default value of 16 represents a reasonable trade between the accurate approximation to the ideal filter and the time to design the filter.

Minimum phase

To design a filter that is minimum phase, select **Minimum phase**. Clearing the **Minimum phase** option removes the phase constraint—the resulting design is not minimum phase.

Minimum order

When you select this parameter, the design method determines and design the minimum order filter to meet your specifications. Some filters do not provide this parameter. Select **Any**, **Even**, or **Odd** from the drop-down list to direct the design to be any minimum order, or minimum even order, or minimum odd order.

Note: Generally, **Minimum order** designs are not available for IIR filters.

Match exactly

Specifies that the resulting filter design matches either the passband or stopband or both bands when you select **passband** or **stopband** or **both** from the drop-down list.

Stopband Shape

Stopband shape lets you specify how the stopband changes with increasing frequency. Choose one of the following options:

- **Flat** — Specifies that the stopband is flat. The attenuation does not change as the frequency increases.
- **Linear** — Specifies that the stopband attenuation changes linearly as the frequency increases. Change the slope of the stopband by setting **Stopband decay**.
- **1/f** — Specifies that the stopband attenuation changes exponentially as the frequency increases, where **f** is the frequency. Set the power (exponent) for the decay in **Stopband decay**.

Stopband Decay

When you set Stopband shape, Stopband decay specifies the amount of decay applied to the stopband. the following conditions apply to Stopband decay based on the value of Stopband Shape:

- When you set **Stopband shape** to **Flat**, **Stopband decay** has no affect on the stopband.
- When you set **Stopband shape** to **Linear**, enter the slope of the stopband in units of dB/rad/s. `filterBuilder` applies that slope to the stopband.
- When you set **Stopband shape** to **1/f**, enter a value for the exponent n in the relation $(1/f)^n$ to define the stopband decay. `filterBuilder` applies the $(1/f)^n$ relation to the stopband to result in an exponentially decreasing stopband attenuation.

Filter implementation

Structure

For the filter specifications and design method you select, this parameter lists the filter structures available to implement your filter. By default, FIR filters use direct-form structure, and IIR filters use direct-form II filters with SOS.

Use a System object to implement filter

This check box appears when you set **Filter type** to **Single-rate**. Selecting this check box gives you the choice of using a System object to implement the filter. By default, this check box is cleared.

This check box no longer appears when you set **Filter type** to **Interpolator**, **Decimator**, or **Sample-rate converter**. The filter builder always implements the filter as a System object.

Comb Filter Design — Main Pane

Comb Design

Design a comb filter.

Save variable as:

Main | Data Types | Code Generation

Filter specifications

Comb Type:

Order mode: Order:

Frequency specifications

Frequency constraints:

Quality factor:

Frequency units:

Notch Frequencies:

Magnitude specifications

No magnitude constraints can be specified when specifying a filter order.

Algorithm

Design method:

Filter implementation

Structure:

Use a System object to implement filter

Filter specifications

Parameters in this group enable you to specify the type of comb filter and the number of peaks or notches.

Comb Type

Select **Notch** or **Peak** from the drop-down list. **Notch** creates a comb filter that attenuates a set of harmonically related frequencies. **Peak** creates a comb filter that amplifies a set of harmonically related frequencies.

Order mode

Select **Order** or **Number of Peaks/Notches** from the drop-down menu.

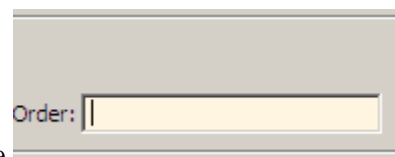

Select **Order** to enter the desired filter order in the dialog box. The comb filter has notches or peaks at increments of $2/\text{Order}$ in normalized frequency units.

Select **Number of Peaks** or **Number of Notches** to specify the number of peaks or notches and the **Shelving filter order**

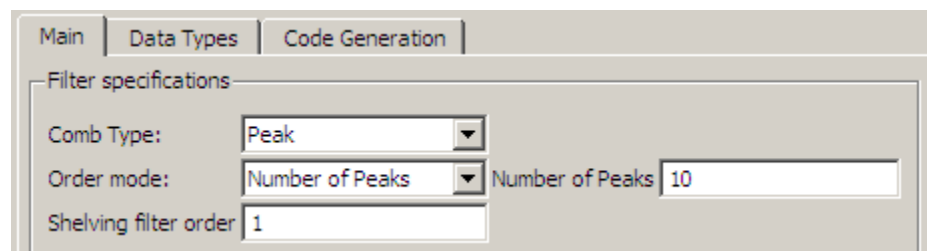

Shelving filter order

The **Shelving filter order** is a positive integer that determines the sharpness of the peaks or notches. Larger values result in sharper peaks or notches.

Frequency specifications

Parameters in this group enable you to specify the frequency constraints and frequency units.

Frequency specifications

Select **Quality factor** or **Bandwidth**.

Quality factor is the ratio of the center frequency of the peak or notch to the bandwidth calculated at the -3 dB point.

Bandwidth specifies the bandwidth of the peak or notch. By default the bandwidth is measured at the -3 dB point. For example, setting the bandwidth equal to 0.1 results in 3 dB frequencies at normalized frequencies 0.05 above and below the center frequency of the peak or notch.

Frequency Units

Specify the frequency units. The default is normalized frequency. Choosing an option in Hz enables the **Input Fs** dialog box.

Magnitude specifications

Specify the units for the magnitude specification and the gain at which the bandwidth is measured. This menu is disabled if you specify a filter order. Select one of the following magnitude units from the drop down list:

- **dB** — Specify the magnitude in decibels (default).
- **Squared** — Specify the magnitude in squared units.

Bandwidth gain — Specify the gain at which the bandwidth is measured. The default is -3 dB.

Algorithm

The parameters in this group allow you to specify the design method and structure that `filterBuilder` uses to implement your filter.

Design Method

The IIR Butterworth design is the only option for peaking or notching comb filters.

Filter implementation

Structure

For the filter specifications and design method you select, this parameter lists the filter structures available to implement your filter.

Use a System object to implement filter

Selecting this check box gives you the choice of using a System object to implement the filter. By default, the check box is cleared.

Differentiator Filter Design — Main Pane

Differentiator Design

Differentiator Design

Design a differentiator.

Save variable as: Hdf View Filter Response

Main Data Types Code Generation

Filter specifications

Order mode: Minimum

Filter type: Single-rate

Frequency specifications

Frequency units: Normalized (0 to 1)

Fpass: 0.45 Fstop: 0.55

Magnitude specifications

Magnitude units: dB

Apass: 1 Astop: 60

Algorithm

Design method: Equiripple

Design options

Density factor: 16

Filter implementation

Structure: Direct-form FIR

Use a System object to implement filter

OK Cancel Help Apply

Filter specifications

Parameters in this group enable you to specify your filter format, such as the impulse response and the filter order. Graphically, the filter specifications look similar to those shown in the following figure.

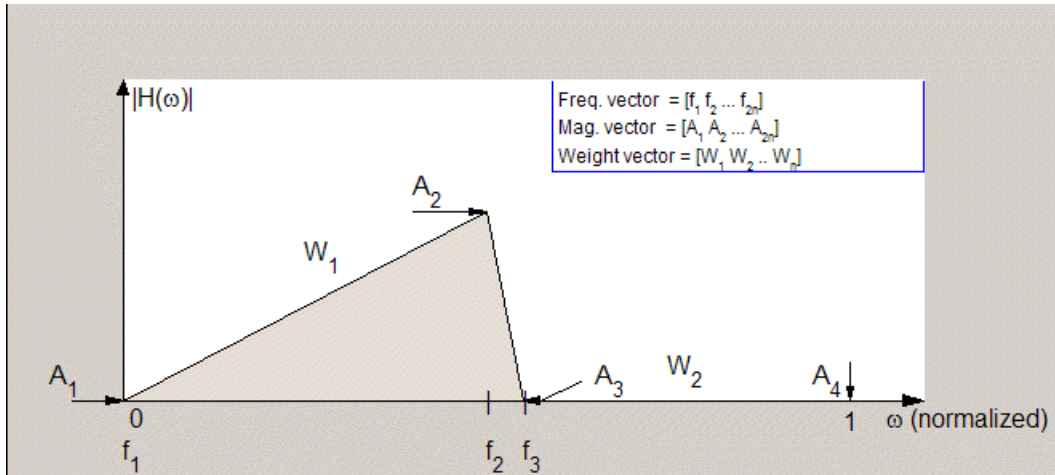

In the figure, regions between specification values such as **Fpass** (f_1) and **Fstop** (f_3) represent transition regions where the filter response is not explicitly defined.

Order mode

Select **Minimum** (the default) or **Specify** from the drop-down list. Selecting **Specify** enables the **Order** option (see the following sections) so you can enter the filter order.

Filter type

Select **Single-rate**, **Decimator**, **Interpolator**, or **Sample-rate converter**. Your choice determines the type of filter as well as the design methods and structures that are available to implement your filter. By default, `filterBuilder` specifies single-rate filters.

- Selecting **Decimator** or **Interpolator** activates the **Decimation Factor** or the **Interpolation Factor** options respectively.
- Selecting **Sample-rate converter** activates both factors.

When you design either a decimator or an interpolator, the resulting filter is a bandpass filter that either decimates or interpolates your input signal.

Order

Enter the filter order. This option is enabled only if **Specify** was selected for **Order mode**.

Decimation Factor

Enter the decimation factor. This option is enabled only if the **Filter type** is set to **Decimator** or **Sample-rate converter**. The default factor value is 2.

Interpolation Factor

Enter the decimation factor. This option is enabled only if the **Filter type** is set to **Interpolator** or **Sample-rate converter**. The default factor value is 2.

Frequency specifications

The parameters in this group allow you to specify your filter response curve.

Frequency constraints

This option is only available when you specify the order of the filter design. Supported options are **Unconstrained** and **Passband edge and stopband edge**.

Frequency units

Use this parameter to specify whether your frequency settings are normalized or in absolute frequency. Select **Normalized (0–1)** to enter frequencies in normalized form. This behavior is the default. To enter frequencies in absolute values, select one of the frequency units from the drop-down list—**Hz**, **KHz**, **MHz**, or **GHz**. Selecting one of the unit options enables the **Input Fs** parameter.

Input Fs

Fs, specified in the units you selected for **Frequency units**, defines the sampling frequency at the filter input. When you provide an input sampling frequency, all frequencies in the specifications are in the selected units as well. This parameter is available when you select one of the frequency options from the **Frequency units** list.

Fpass

Enter the frequency at the end of the passband. Specify the value in either normalized frequency units or the absolute units you select **Frequency units**.

Fstop

Enter the frequency at the start of the stopband. Specify the value in either normalized frequency units or the absolute units you select **Frequency units**.

Magnitude specifications

The parameters in this group let you specify the filter response in the passbands and stopbands.

Magnitude constraints

This option is only available when you specify the order of your filter design. The options for **Magnitude constraints** depend on the value of the **Frequency constraints**. If the value of **Frequency constraints** is **Unconstrained**, **Magnitude constraints** must be **Unconstrained**. If the value of **Frequency constraints** is **Passband edge and stopband edge**, **Magnitude constraints** can be **Unconstrained**, **Passband ripple**, or **Stopband attenuation**.

Magnitude units

Specify the units for any parameter you provide in magnitude specifications. Select one of the following options from the drop-down list.

- **Linear** — Specify the magnitude in linear units.
- **dB** — Specify the magnitude in decibels (default).
- **Squared** — Specify the magnitude in squared units.

Apass

Enter the filter ripple allowed in the passband in the units you choose for **Magnitude units**, either linear or decibels.

Astop2

Enter the filter attenuation in the second stopband in the units you choose for **Magnitude units**, either linear or decibels.

Algorithm

The parameters in this group allow you to specify the design method and structure that `filterBuilder` uses to implement your filter.

Design Method

Lists the design methods available for the frequency and magnitude specifications you entered. When you change the specifications for a filter, such as changing the impulse response, the methods available to design filters changes as well. The default IIR design method is usually Butterworth, and the default FIR method is equiripple.

Scale SOS filter coefficients to reduce chance of overflow

Selecting this parameter directs the design to scale the filter coefficients to reduce the chances that the inputs or calculations in the filter overflow and exceed the representable range of the filter. Clearing this option removes the scaling. This parameter applies only to IIR filters.

Design Options

The options for each design are specific for each design method. This section does not present all of the available options for all designs and design methods. There are many more that you encounter as you select different design methods and filter specifications.

Density factor

Density factor controls the density of the frequency grid over which the design method optimization evaluates your filter response function. The number of equally spaced points in the grid is the value you enter for **Density factor** times (filter order + 1).

Increasing the value creates a filter that more closely approximates an ideal equiripple filter but increases the time required to design the filter. The default value of 16 represents a reasonable trade between the accurate approximation to the ideal filter and the time to design the filter.

Wpass

Passband weight. This option is only available for a specified-order design when **Frequency constraints** is equal to Passband edge and stopband edge and the **Design method** is Equiripple.

Wstop

Stopband weight. This option is only available for a specified-order design when **Frequency constraints** is equal to Passband edge and stopband edge and the **Design method** is Equiripple.

Filter implementation

Structure

For the filter specifications and design method you select, this parameter lists the filter structures available to implement your filter. By default, FIR filters use direct-form structure, and IIR filters use direct-form II filters with SOS.

Use a System object to implement filter

This check box appears when you set **Filter type** to **Single-rate**. Selecting this check box gives you the choice of using a System object to implement the filter. By default, the check box is cleared.

This check box no longer appears when you set **Filter type** to **Interpolator**, **Decimator**, or **Sample-rate converter**. The filter builder always implements the filter as a System object.

Fractional Delay Design — Main Pane

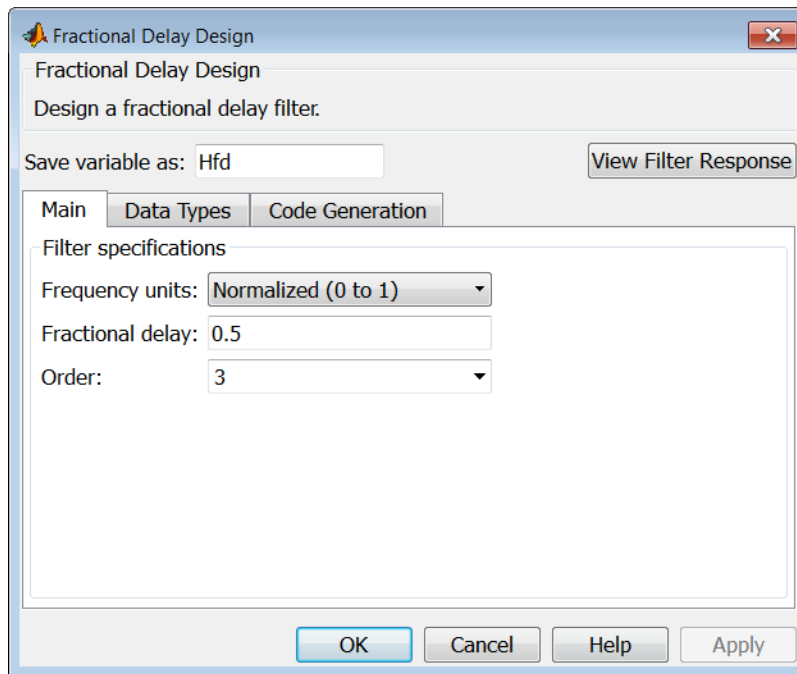

Frequency specifications

Parameters in this group enable you to specify your filter format, such as the fractional delay and the filter order.

Order

If you choose **Specify** for **Order mode**, enter your filter order in this field, or select the order from the drop-down list. `filterBuilder` designs a filter with the order you specify.

Fractional delay

Specify a value between 0 and 1 samples for the filter fractional delay. The default value is 0.5 samples.

Frequency units

Use this parameter to specify whether your frequency settings are normalized or in absolute frequency. Select **Normalized (0–1)** to enter frequencies in normalized form. This behavior is the default. To enter frequencies in absolute values, select one of the frequency units from the drop-down list—Hz, kHz, MHz, or GHz. Selecting one of the unit options enables the **Input Fs** parameter.

Input Fs

Fs, specified in the units you selected for **Frequency units**, defines the sampling frequency at the filter input. When you provide an input sampling frequency, all frequencies in the specifications are in the selected units as well. This parameter is available when you select one of the frequency options from the **Frequency units** list.

Halfband Filter Design — Main Pane

Halfband Design

Design a Halfband filter.

Save variable as: View Filter Response

Main | Data Types | Code Generation

Frequency specifications

Impulse response:

Order mode:

Response type:

Filter type:

Frequency specifications

Frequency units:

Transition width:

Magnitude specifications

Magnitude units:

Astop:

Algorithm

Design method:

Design options

Minimum phase

Stopband shape:

Stopband decay:

Filter implementation

Structure:

Use a System object to implement filter

OK Cancel Help Apply

Filter specifications

Parameters in this group enable you to specify your filter type and order.

Impulse response

Select **FIR** or **IIR** from the drop-down list, where **FIR** is the default impulse response. When you choose an impulse response, the design methods and structures you can use to implement your filter change accordingly.

Note: The design methods and structures for FIR filters are not the same as the methods and structures for IIR filters.

Order mode

Select **Minimum** (the default) or **Specify** from the drop-down list. Selecting **Specify** enables the **Order** option (see the following sections) so you can enter the filter order.

Filter type

Select **Single-rate**, **Decimator**, or **Interpolator**. By default, **filterBuilder** specifies single-rate filters.

When you design either a decimator or an interpolator, the resulting filter is a bandpass filter that decimates or interpolates your input by a factor of two.

Order

Enter the filter order. This option is enabled only if **Specify** was selected for **Order mode**.

Frequency specifications

The parameters in this group allow you to specify your filter response curve. Graphically, the filter specifications for a halfband lowpass filter look similar to those shown in the following figure.

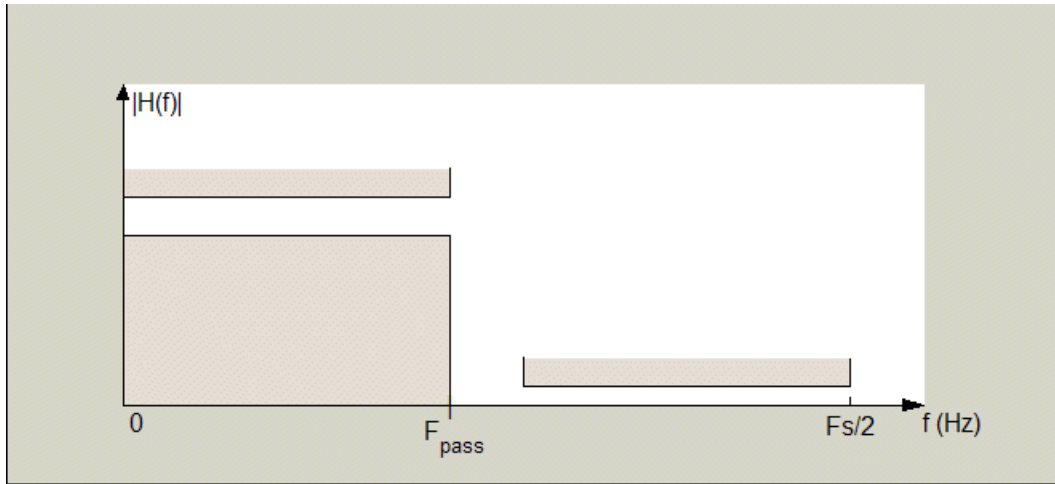

In the figure, the transition region lies between the end of the passband and the start of the stopband. The width is defined explicitly by the value of **Transition width**.

Frequency units

Use this parameter to specify whether your frequency settings are normalized or in absolute frequency. Select **Normalized (0–1)** to enter frequencies in normalized form. This behavior is the default. To enter frequencies in absolute values, select one of the frequency units from the drop-down list—Hz, kHz, MHz, or GHz. Selecting one of the unit options enables the **Input Fs** parameter.

Input Fs

Fs, specified in the units you selected for **Frequency units**, defines the sampling frequency at the filter input. When you provide an input sampling frequency, all frequencies in the specifications are in the selected units as well. This parameter is available when you select one of the frequency options from the **Frequency units** list.

Transition width

Specify the width of the transition between the end of the passband and the edge of the stopband. Specify the value in normalized frequency units or the absolute units you select in **Frequency units**.

Magnitude specifications

The parameters in this group let you specify the filter response in the passbands and stopbands.

Magnitude units

Specify the units for any parameter you provide in magnitude specifications. Select one of the following options from the drop-down list.

- **Linear** — Specify the magnitude in linear units.
- **dB** — Specify the magnitude in decibels (default).

Astop

Enter the filter attenuation in the stopband in the units you choose for **Magnitude units**, either linear or decibels.

Algorithm

The parameters in this group allow you to specify the design method and structure that filterBuilder uses to implement your filter.

Design Method

Lists the design methods available for the frequency and magnitude specifications you entered. For FIR halfband filters, the available design options are **Equiripple** and **Kaiser window**. For IIR halfband filters, the available design options are **Butterworth**, **Elliptic**, and **IIR quasi-linear phase**.

Design Options

The following design options are available for FIR halfband filters when the user specifies an equiripple design:

Minimum phase

To design a filter that is minimum phase, select **Minimum phase**. Clearing the **Minimum phase** option removes the phase constraint—the resulting design is not minimum phase.

Stopband Shape

Stopband shape lets you specify how the stopband changes with increasing frequency. Choose one of the following options:

- **Flat** — Specifies that the stopband is flat. The attenuation does not change as the frequency increases.
- **Linear** — Specifies that the stopband attenuation changes linearly as the frequency increases. Change the slope of the stopband by setting **Stopband decay**.
- **1/f** — Specifies that the stopband attenuation changes exponentially as the frequency increases, where **f** is the frequency. Set the power (exponent) for the decay in **Stopband decay**.

Stopband Decay

When you set Stopband shape, Stopband decay specifies the amount of decay applied to the stopband. the following conditions apply to Stopband decay based on the value of Stopband Shape:

- When you set **Stopband shape** to **Flat**, **Stopband decay** has no affect on the stopband.
- When you set **Stopband shape** to **Linear**, enter the slope of the stopband in units of dB/rad/s. `filterBuilder` applies that slope to the stopband.
- When you set **Stopband shape** to **1/f**, enter a value for the exponent n in the relation $(1/f)^n$ to define the stopband decay. `filterBuilder` applies the $(1/f)^n$ relation to the stopband to result in an exponentially decreasing stopband attenuation.

Filter implementation

Structure

For the filter specifications and design method you select, this parameter lists the filter structures available to implement your filter.

Use a System object to implement filter

This check box appears when you set **Filter type** to **Single-rate**. Selecting this check box gives you the choice of using a System object to implement the filter. By default, the check box is cleared.

This check box no longer appears when you set **Filter type** to either **Interpolator** or **Decimator**. The filter builder always implements the filter as a System object.

Highpass Design

Highpass Design
Design a Highpass filter.

Save variable as: Hhp View Filter Response

Main **Data Types** Code Generation

Filter specifications

Impulse response: FIR

Order mode: Minimum

Filter type: Single-rate

Frequency specifications

Frequency units: Normalized (0 to 1)

Fstop: .45 Fpass: .55

Magnitude specifications

Magnitude units: dB

Astop: 60 Apass: 1

Algorithm

Design method: Equiripple

Design options

Density factor: 16

Phase constraint: Linear

Minimum order: Any

Stopband shape: Flat

Stopband decay: 0

Uniform grid

Filter implementation

Structure: Direct-form FIR

Use a System object to implement filter

OK Cancel Help Apply

Filter specifications

Parameters in this group enable you to specify your filter format, such as the impulse response and the filter order.

Impulse response

Select **FIR** or **IIR** from the drop-down list, where **FIR** is the default impulse response. When you choose an impulse response, the design methods and structures you can use to implement your filter change accordingly.

Note: The design methods and structures for FIR filters are not the same as the methods and structures for IIR filters.

Order mode

Select **Minimum** (the default) or **Specify** from the drop-down list. Selecting **Specify** enables the **Order** option so you can enter the filter order.

If your **Impulse response** is **IIR**, you can specify an equal order for the numerator and denominator, or different numerator and denominator orders. The default is equal orders. To specify a different denominator order, check the **Denominator order** box.

Filter type

This option is only available if you have the DSP System Toolbox software. Select **Single-rate**, **Decimator**, **Interpolator**, or **Sample-rate converter**. Your choice determines the type of filter as well as the design methods and structures that are available to implement your filter. By default, `filterBuilder` specifies single-rate filters.

- Selecting **Decimator** or **Interpolator** activates the **Decimation Factor** or the **Interpolation Factor** options respectively.
- Selecting **Sample-rate converter** activates both factors.

When you design either a decimator or an interpolator, the resulting filter is a highpass filter that either decimates or interpolates your input signal.

Order

Enter the filter order. This option is enabled only if **Specify** was selected for **Order mode**.

Decimation Factor

Enter the decimation factor. This option is enabled only if the **Filter type** is set to Decimator or Sample-rate converter. The default factor value is 2.

Interpolation Factor

Enter the interpolation factor. This option is enabled only if the **Filter type** is set to Interpolator or Sample-rate converter. The default factor value is 2.

Frequency specifications

The parameters in this group allow you to specify your filter response curve. Graphically, the filter specifications look similar to those shown in the following figure.

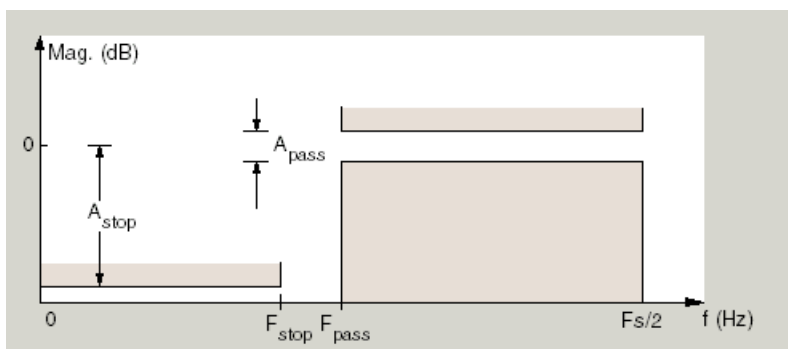

In the figure, the region between specification values F_{stop} and F_{pass} represents the transition region where the filter response is not explicitly defined.

Frequency constraints

Select the filter features to use to define the frequency response characteristics. The list contains the following options, when available for the filter specifications.

- **Stopband edge and passband edge** — Define the filter by specifying the frequencies for the edges for the stopband and passband.
- **Passband edge** — Define the filter by specifying the frequency for the edge of the passband.
- **Stopband edge** — Define the filter by specifying the frequency for the edges of the stopband.
- **Stopband edge and 3dB point** — Define the filter by specifying the stopband edge frequency and the 3-dB down point (IIR designs).
- **3dB point and passband edge** — Define the filter by specifying the 3-dB down point and passband edge frequency (IIR designs).

- **3dB point** — Define the filter by specifying the frequency for the 3-dB point (IIR designs or maxflat FIR).
- **6dB point** — Define the filter by specifying the frequency for the 6-dB point in the filter response (FIR designs).

Frequency units

Use this parameter to specify whether your frequency settings are normalized or in absolute frequency. Select **Normalized (0–1)** to enter frequencies in normalized form. This behavior is the default. To enter frequencies in absolute values, select one of the frequency units from the drop-down list—Hz, kHz, MHz, or GHz. Selecting one of the unit options enables the **Input Fs** parameter.

Input Fs

Fs, specified in the units you selected for **Frequency units**, defines the sampling frequency at the filter input. When you provide an input sampling frequency, all frequencies in the specifications are in the selected units as well. This parameter is available when you select one of the frequency options from the **Frequency units** list.

Fpass

Enter the frequency at the of the passband. Specify the value in either normalized frequency units or the absolute units you select **Frequency units**.

Fstop

Enter the frequency at the start of the stopband. Specify the value in either normalized frequency units or the absolute units you select **Frequency units**.

Magnitude specifications

The parameters in this group let you specify the filter response in the passbands and stopbands.

Magnitude units

Specify the units for any parameter you provide in magnitude specifications. Select one of the following options from the drop-down list.

- **Linear** — Specify the magnitude in linear units.
- **dB** — Specify the magnitude in decibels (default).
- **Squared** — Specify the magnitude in squared units.

Astop

Enter the filter attenuation in the stopband in the units you choose for **Magnitude units**, either linear or decibels.

Apass

Enter the filter ripple allowed in the passband in the units you choose for **Magnitude units**, either linear or decibels.

Algorithm

The parameters in this group allow you to specify the design method and structure that `filterBuilder` uses to implement your filter.

Design Method

Lists the design methods available for the frequency and magnitude specifications you entered. When you change the specifications for a filter, such as changing the impulse response, the methods available to design filters changes as well. The default IIR design method is usually Butterworth, and the default FIR method is equiripple.

Scale SOS filter coefficients to reduce chance of overflow

Selecting this parameter directs the design to scale the filter coefficients to reduce the chances that the inputs or calculations in the filter overflow and exceed the representable range of the filter. Clearing this option removes the scaling. This parameter applies only to IIR filters.

Design Options

The options for each design are specific for each design method. This section does not present all of the available options for all designs and design methods. There are many more that you encounter as you select different design methods and filter specifications. The following options represent some of the most common ones available.

Density factor

Density factor controls the density of the frequency grid over which the design method optimization evaluates your filter response function. The number of equally spaced points in the grid is the value you enter for **Density factor** times (filter order + 1).

Increasing the value creates a filter that more closely approximates an ideal equiripple filter but increases the time required to design the filter. The default value of 16 represents a reasonable trade between the accurate approximation to the ideal filter and the time to design the filter.

Phase constraint

This option only applies when you have the DSP System Toolbox software and when the **Design method** is `equiripple`. Select one of `Linear`, `Minimum`, or `Maximum`.

Minimum order — This option only applies when you have the DSP System Toolbox software and the **Order mode** is `Minimum`.

Select `Any` (default), `Even`, or `Odd`. Selecting `Even` or `Odd` forces the minimum-order design to be an even or odd order.

Match Exactly

Specifies that the resulting filter design matches either the passband or stopband when you select `Passband` or `Stopband`.

Stopband Shape

Stopband shape lets you specify how the stopband changes with increasing frequency. Choose one of the following options:

- **Flat** — Specifies that the stopband is flat. The attenuation does not change as the frequency increases.
- **Linear** — Specifies that the stopband attenuation changes linearly as the frequency increases. Change the slope of the stopband by setting **Stopband decay**.
- **1/f** — Specifies that the stopband attenuation changes exponentially as the frequency increases, where f is the frequency. Set the power (exponent) for the decay in **Stopband decay**.

Stopband Decay

When you set Stopband shape, Stopband decay specifies the amount of decay applied to the stopband. The following conditions apply to Stopband decay based on the value of Stopband Shape:

- When you set **Stopband shape** to `Flat`, **Stopband decay** has no effect on the stopband.
- When you set **Stopband shape** to `Linear`, enter the slope of the stopband in units of dB/rad/s. `filterBuilder` applies that slope to the stopband.
- When you set **Stopband shape** to `1/f`, enter a value for the exponent n in the relation $(1/f)^n$ to define the stopband decay. `filterBuilder` applies the $(1/f)^n$ relation to the stopband to result in an exponentially decreasing stopband attenuation.

Wpass

Passband weight. This option only applies when **Impulse response** is FIR and **Order mode** is Specify.

Wstop

Stopband weight. This option only applies when **Impulse response** is FIR and **Order mode** is Specify.

Filter implementation**Structure**

For the filter specifications and design method you select, this parameter lists the filter structures available to implement your filter. By default, FIR filters use direct-form structure, and IIR filters use direct-form II filters with SOS.

Use a System object to implement filter

This check box appears when you set **Filter type** to Single-rate. Selecting this check box gives you the choice of using a System object to implement the filter. By default, the check box is cleared.

This check box no longer appears when you set **Filter type** to Interpolator, Decimator, or Sample-rate converter. The filter builder always implements the filter as a System object.

Hilbert Filter Design — Main Pane

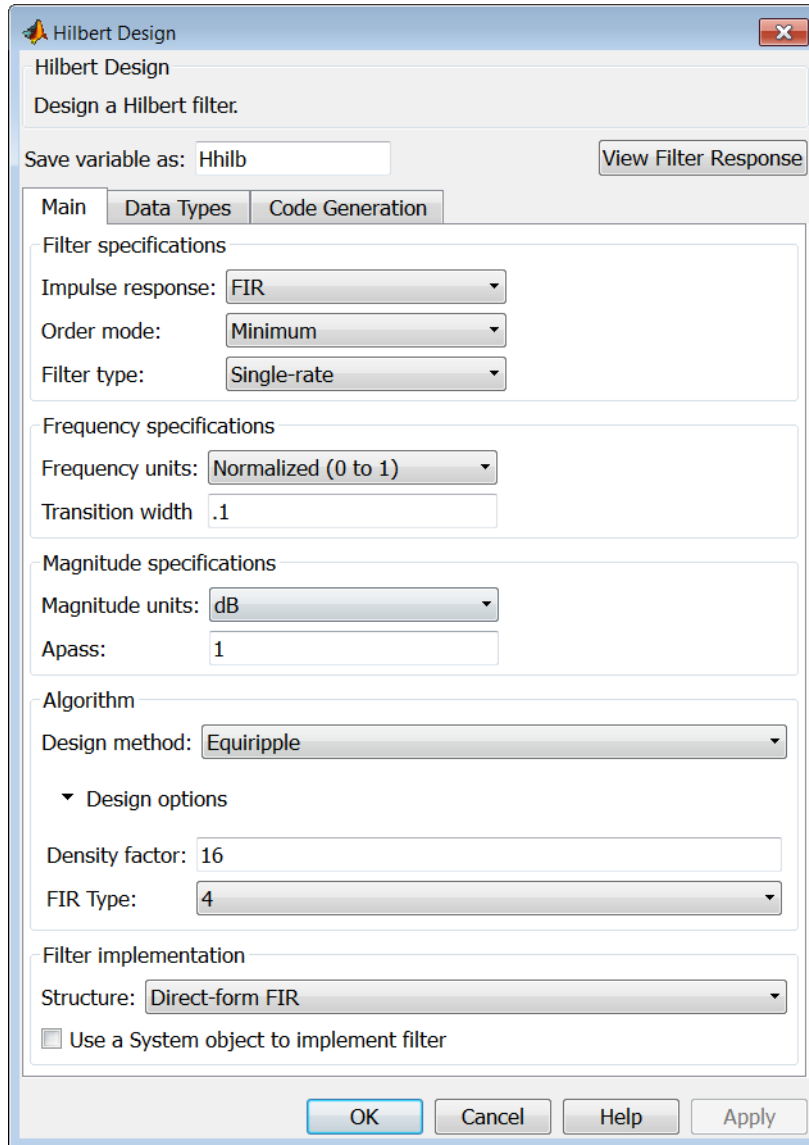

Filter specifications

Parameters in this group enable you to specify your filter format, such as the impulse response and the filter order.

Impulse response

Select **FIR** or **IIR** from the drop-down list, where **FIR** is the default impulse response. When you choose an impulse response, the design methods and structures you can use to implement your filter change accordingly.

Note: The design methods and structures for **FIR** filters are not the same as the methods and structures for **IIR** filters.

Order mode

This option is only available if you have the DSP System Toolbox software. Select either **Minimum** (the default) or **Specify** from the drop-down list. Selecting **Specify** enables the **Order** option (see the following sections) so you can enter the filter order.

Filter type

This option is only available if you have the DSP System Toolbox software. Select **Single-rate**, **Decimator**, **Interpolator**, or **Sample-rate converter**. Your choice determines the type of filter as well as the design methods and structures that are available to implement your filter. By default, **filterBuilder** specifies single-rate filters.

- Selecting **Decimator** or **Interpolator** activates the **Decimation Factor** or the **Interpolation Factor** options respectively.
- Selecting **Sample-rate converter** activates both factors.

When you design either a decimator or an interpolator, the resulting filter is a bandpass filter that either decimates or interpolates your input signal.

Order

Enter the filter order. This option is enabled only if **Specify** was selected for **Order mode**.

Decimation Factor

Enter the decimation factor. This option is enabled only if the **Filter type** is set to **Decimator** or **Sample-rate converter**. The default factor value is 2.

Interpolation Factor

Enter the decimation factor. This option is enabled only if the **Filter type** is set to Interpolator or Sample-rate converter. The default factor value is 2.

Frequency specifications

The parameters in this group allow you to specify your filter response curve. Graphically, the filter specifications look similar to those shown in the following figure.

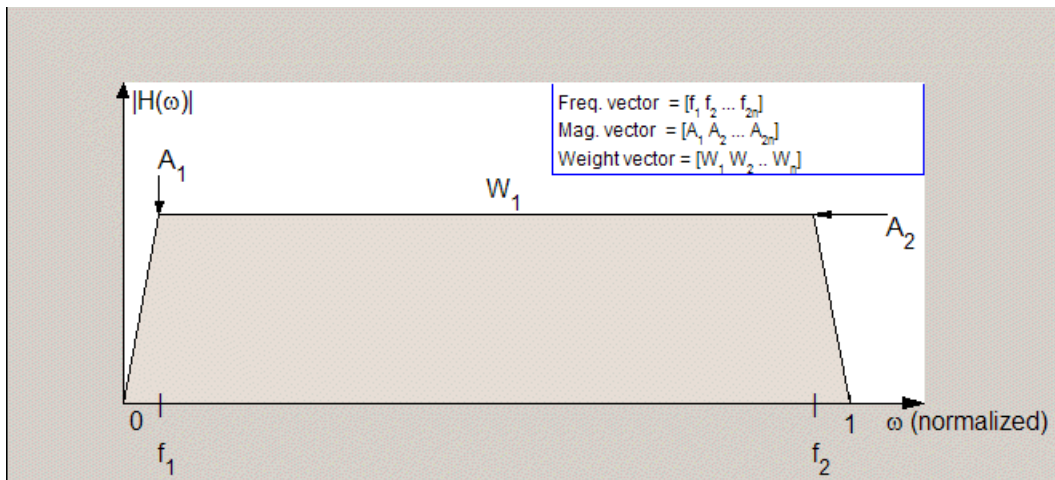

In the figure, the regions between 0 and f_1 and between f_2 and 1 represent the transition regions where the filter response is explicitly defined by the transition width.

Frequency units

Use this parameter to specify whether your frequency settings are normalized or in absolute frequency. Select **Normalized (0–1)** to enter frequencies in normalized form. This behavior is the default. To enter frequencies in absolute values, select one of the frequency units from the drop-down list—Hz, kHz, MHz, or GHz. Selecting one of the unit options enables the **Input Fs** parameter.

Input Fs

Fs, specified in the units you selected for **Frequency units**, defines the sampling frequency at the filter input. When you provide an input sampling frequency, all frequencies in the specifications are in the selected units as well. This parameter is

available when you select one of the frequency options from the **Frequency units** list.

Transition width

Specify the width of the transitions at the ends of the passband. Specify the value in normalized frequency units or the absolute units you select in **Frequency units**.

Magnitude specifications

The parameters in this group let you specify the filter response in the passbands and stopbands.

Magnitude units

Specify the units for any parameter you provide in magnitude specifications. Select one of the following options from the drop-down list.

- **Linear** — Specify the magnitude in linear units.
- **dB** — Specify the magnitude in decibels (default)
- **Squared** — Specify the magnitude in squared units.

Apass

Enter the filter ripple allowed in the passband in the units you choose for **Magnitude units**, either linear or decibels.

Algorithm

The parameters in this group allow you to specify the design method and structure that filterBuilder uses to implement your filter.

Design Method

Lists the design methods available for the frequency and magnitude specifications you entered. When you change the specifications for a filter, such as changing the impulse response, the methods available to design filters changes as well. The default IIR design method is usually Butterworth, and the default FIR method is equiripple.

Scale SOS filter coefficients to reduce chance of overflow

Selecting this parameter directs the design to scale the filter coefficients to reduce the chances that the inputs or calculations in the filter overflow and exceed the representable range of the filter. Clearing this option removes the scaling. This parameter applies only to IIR filters.

Design Options

The options for each design are specific for each design method. This section does not present all of the available options for all designs and design methods. There are many more that you encounter as you select different design methods and filter specifications. The following options represent some of the most common ones available.

Density factor

Density factor controls the density of the frequency grid over which the design method optimization evaluates your filter response function. The number of equally spaced points in the grid is the value you enter for **Density factor** times (filter order + 1).

Increasing the value creates a filter that more closely approximates an ideal equiripple filter but increases the time required to design the filter. The default value of 16 represents a reasonable trade between the accurate approximation to the ideal filter and the time to design the filter.

FIR Type

This option is only available in a minimum-order design. Specify whether to design a type 3 or a type 4 FIR filter. The filter type is defined as follows:

- Type 3 — FIR filter with even order antisymmetric coefficients
- Type 4 — FIR filter with odd order antisymmetric coefficients

Select 3 or 4 from the drop-down list.

Filter implementation

Structure

For the filter specifications and design method you select, this parameter lists the filter structures available to implement your filter. By default, FIR filters use direct-form structure, and IIR filters use direct-form II filters with SOS.

Use a System object to implement filter

This check box appears when you set **Filter type** to **Single-rate**. Selecting this check box gives you the choice of using a System object to implement the filter. By default, the check box is cleared.

This check box no longer appears when you set **Filter type** to **Interpolator**, **Decimator**, or **Sample-rate converter**. The filter builder always implements the filter as a System object.

Inverse Sinc Filter Design — Main Pane

Inverse Sinc Design

Inverse Sinc Design

Design an Inverse-sinc filter.

Save variable as: Hsinc View Filter Response

Main Data Types Code Generation

Filter specifications

Order mode: Minimum

Response type: Lowpass

Filter type: Single-rate

Frequency specifications

Frequency units: Normalized (0 to 1)

Fpass: .45 Fstop: .55

Magnitude specifications

Magnitude units: dB

Apass: 1 Astop: 60

Algorithm

Design method: Equiripple

▼ Design options

Density factor: 16

Phase constraint: Linear

Minimum order: Any

Stopband shape: Flat

Stopband decay: 0

Sinc frequency factor: 0.5

Sinc power: 1

Filter implementation

Structure: Direct-form FIR

Use a System object to implement filter

OK Cancel Help Apply

Filter specifications

Parameters in this group enable you to specify your filter format, such as the impulse response and the filter order.

Order mode

Select **Minimum** (the default) or **Specify** from the drop-down list. Selecting **Specify** enables the **Order** option (see the following sections) so you can enter the filter order.

Response type

Select **Lowpass** or **Highpass** to design an inverse sinc lowpass or highpass filter.

Filter type

Select `Single-rate`, `Decimator`, `Interpolator`, or `Sample-rate converter`. Your choice determines the type of filter as well as the design methods and structures that are available to implement your filter. By default, `filterBuilder` specifies single-rate filters.

- Selecting `Decimator` or `Interpolator` activates the **Decimation Factor** or the **Interpolation Factor** options respectively.
- Selecting `Sample-rate converter` activates both factors.

When you design either a decimator or an interpolator, the resulting filter is a bandpass filter that either decimates or interpolates your input signal.

Order

Enter the filter order. This option is enabled only if `Specify` was selected for **Order mode**.

Decimation Factor

Enter the decimation factor. This option is enabled only if the **Filter type** is set to `Decimator` or `Sample-rate converter`. The default factor value is 2.

Interpolation Factor

Enter the decimation factor. This option is enabled only if the **Filter type** is set to `Interpolator` or `Sample-rate converter`. The default factor value is 2.

Frequency specifications

The parameters in this group allow you to specify your filter response curve. Graphically, the filter specifications look similar to those shown in the following figure.

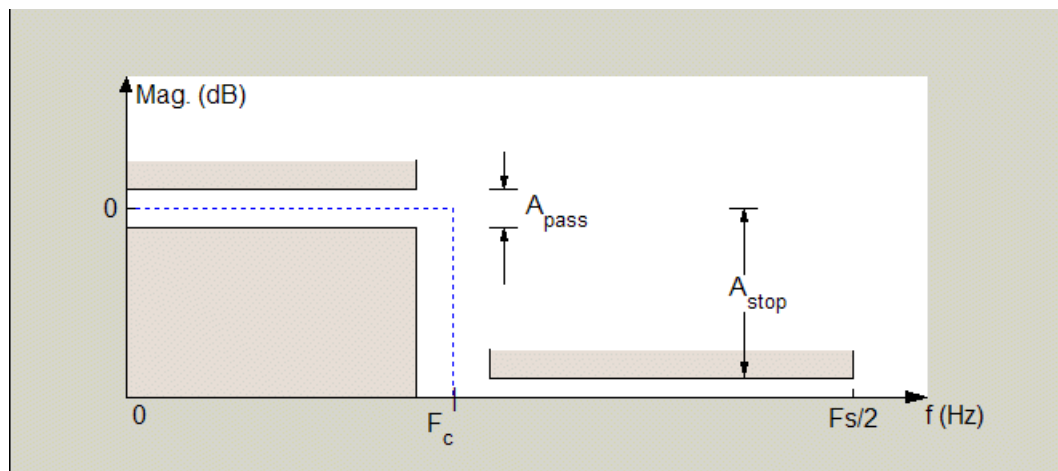

Regions between specification values such as F_{pass} and F_{stop} represent transition regions where the filter response is not explicitly defined.

Frequency constraints

This option is only available when you specify the filter order. The following options are available:

- **Passband and stopband edges** — Define the filter by specifying the frequencies for the edges for the stop- and passbands.
- **Passband edge** — Define the filter by specifying frequencies for the edges of the passband.
- **Stopband edge** — Define the filter by specifying frequencies for the edges of the stopbands.
- **6dB point** — The 6-dB point is the frequency for the point 6 dB point below the passband value.

Frequency units

Use this parameter to specify whether your frequency settings are normalized or in absolute frequency. Select **Normalized (0–1)** to enter frequencies in normalized form. This behavior is the default. To enter frequencies in absolute values, select one of the frequency units from the drop-down list—**Hz**, **kHz**, **MHz**, or **GHz**. Selecting one of the unit options enables the **Input Fs** parameter.

Input Fs

F_s , specified in the units you selected for **Frequency units**, defines the sampling frequency at the filter input. When you provide an input sampling frequency, all frequencies in the specifications are in the selected units as well. This parameter is available when you select one of the frequency options from the **Frequency units** list.

Fpass

Enter the frequency at the end of the passband. Specify the value in either normalized frequency units or the absolute units you select **Frequency units**.

Fstop

Enter the frequency at the start of the stopband. Specify the value in either normalized frequency units or the absolute units you select **Frequency units**.

Magnitude specifications

The parameters in this group let you specify the filter response in the passbands and stopbands.

Magnitude units

Specify the units for any parameter you provide in magnitude specifications. Select one of the following options from the drop-down list.

- **Linear** — Specify the magnitude in linear units.
- **dB** — Specify the magnitude in decibels (default)
- **Squared** — Specify the magnitude in squared units.

Apass

Enter the filter ripple allowed in the passband in the units you choose for **Magnitude units**, either linear or decibels.

Astop

Enter the filter attenuation in the stopband in the units you choose for **Magnitude units**, either linear or decibels.

Algorithm

The parameters in this group allow you to specify the design method and structure that `filterBuilder` uses to implement your filter.

Design Method

Lists the design methods available for the frequency and magnitude specifications you entered. When you change the specifications for a filter, such as changing the impulse response, the methods available to design filters changes as well. The default IIR design method is usually Butterworth, and the default FIR method is equiripple.

Design Options

The options for each design are specific for each design method. This section does not present all of the available options for all designs and design methods. There are many more that you encounter as you select different design methods and filter specifications. The following options represent some of the most common ones available.

Density factor

Density factor controls the density of the frequency grid over which the design method optimization evaluates your filter response function. The number of equally spaced points in the grid is the value you enter for **Density factor** times (filter order + 1).

Increasing the value creates a filter that more closely approximates an ideal equiripple filter but increases the time required to design the filter. The default value of 16 represents a reasonable trade between the accurate approximation to the ideal filter and the time to design the filter.

Phase constraint

Available options are **Linear**, **Minimum**, and **Maximum**.

Stopband Shape

Stopband shape lets you specify how the stopband changes with increasing frequency. Choose one of the following options;

- **Flat** — Specifies that the stopband is flat. The attenuation does not change as the frequency increases.
- **Linear** — Specifies that the stopband attenuation changes linearly as the frequency increases. Change the slope of the stopband by setting **Stopband decay**.
- **1/f** — Specifies that the stopband attenuation changes exponentially as the frequency increases, where **f** is the frequency. Set the power (exponent) for the decay in **Stopband decay**.

Stopband Decay

When you set **Stopband shape**, **Stopband decay** specifies the amount of decay applied to the stopband. The following conditions apply to **Stopband decay** based on the value of **Stopband Shape**:

- When you set **Stopband shape** to **Flat**, **Stopband decay** has no effect on the stopband.
- When you set **Stopband shape** to **Linear**, enter the slope of the stopband in units of dB/rad/s. `filterBuilder` applies that slope to the stopband.
- When you set **Stopband shape** to $1/f$, enter a value for the exponent n in the relation $(1/f)^n$ to define the stopband decay. `filterBuilder` applies the $(1/f)^n$ relation to the stopband to result in an exponentially decreasing stopband attenuation.

Sinc frequency factor

A frequency dilation factor. The sinc frequency factor, C , parameterizes the passband magnitude response for a lowpass design through $H(\omega) = \text{sinc}(C\omega)^{-P}$ and for a highpass design through $H(\omega) = \text{sinc}(C(1-\omega))^{-P}$.

Sinc power

Negative power of passband magnitude response. The sinc power, P , parameterizes the passband magnitude response for a lowpass design through $H(\omega) = \text{sinc}(C\omega)^{-P}$ and for a highpass design through $H(\omega) = \text{sinc}(C(1-\omega))^{-P}$.

Filter implementation

Structure

For the filter specifications and design method you select, this parameter lists the filter structures available to implement your filter. By default, FIR filters use direct-form structure.

Use a System object to implement filter

This check box appears when you set **Filter type** to **Single-rate**. Selecting this check box gives you the choice of using a System object to implement the filter. By default, the check box is cleared.

This check box no longer appears when you set **Filter type** to **Interpolator**, **Decimator**, or **Sample-rate converter**. The filter builder always implements the filter as a System object.

Lowpass Design

Lowpass Design
Design a lowpass filter.

Save variable as: Hlp3 View Filter Response

Main **Data Types** Code Generation

Filter specifications

Impulse response: FIR

Order mode: Minimum

Filter type: Single-rate

Frequency specifications

Frequency units: Normalized (0 to 1)

Fpass: .45 Fstop: .55

Magnitude specifications

Magnitude units: dB

Apass: 1 Astop: 60

Algorithm

Design method: Equiripple

Design options

Density factor: 16

Phase constraint: Linear

Minimum order: Any

Stopband shape: Flat

Stopband decay: 0

Uniform grid

Filter implementation

Structure: Direct-form FIR

Use a System object to implement filter

OK Cancel Help Apply

Filter specifications

Parameters in this group enable you to specify your filter format, such as the impulse response and the filter order.

Impulse response

Select **FIR** or **IIR** from the drop-down list, where **FIR** is the default impulse response. When you choose an impulse response, the design methods and structures you can use to implement your filter change accordingly.

Note: The design methods and structures for FIR filters are not the same as the methods and structures for IIR filters.

Order mode

Select **Minimum** (the default) or **Specify** from the drop-down list. Selecting **Specify** enables the **Order** option (see the following sections) so you can enter the filter order.

If your **Impulse response** is **IIR**, you can specify an equal order for the numerator and denominator, or different numerator and denominator orders. The default is equal orders. To specify a different denominator order, check the **Denominator order** box.

Filter type

This option is only available if you have the DSP System Toolbox. Select **Single-rate**, **Decimator**, **Interpolator**, or **Sample-rate converter**. Your choice determines the type of filter as well as the design methods and structures that are available to implement your filter. By default, `filterBuilder` specifies single-rate filters.

- Selecting **Decimator** or **Interpolator** activates the **Decimation Factor** or the **Interpolation Factor** options respectively.
- Selecting **Sample-rate converter** activates both factors.

When you design either a decimator or an interpolator, the resulting filter is a bandpass filter that either decimates or interpolates your input signal.

Order

Enter the filter order. This option is enabled only if **Specify** was selected for **Order mode**.

Decimation Factor

Enter the decimation factor. This option is enabled only if the **Filter type** is set to Decimator or Sample-rate converter. The default factor value is 2.

Interpolation Factor

Enter the decimation factor. This option is enabled only if the **Filter type** is set to Interpolator or Sample-rate converter. The default factor value is 2.

Frequency specifications

The parameters in this group allow you to specify your filter response curve. Graphically, the filter specifications look similar to the one shown in the following figure.

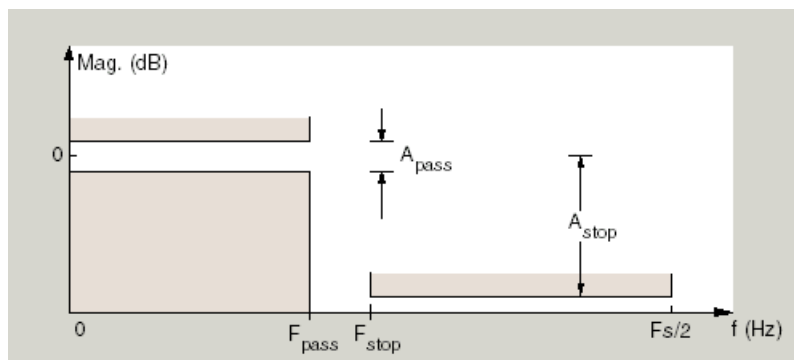

In the figure, regions between specification values such as F_{pass} and F_{stop} represent transition regions where the filter response is not explicitly defined.

Frequency constraints

Select the filter features to use to define the frequency response characteristics. The list contains the following options, when available for the filter specifications.

- **Passband and stopband edge** — Define the filter by specifying the frequencies for the edge of the stopband and passband.
- **Passband edge** — Define the filter by specifying the frequency for the edge of the passband.
- **Stopband edge** — Define the filter by specifying the frequency for the edges of the stopband.

- **Passband edge and 3dB point** — Define the filter by specifying the passband edge frequency and the 3-dB down point (IIR designs).
- **3dB point and stopband edge** — Define the filter by specifying the 3-dB down point and stopband edge frequency (IIR designs).
- **3dB point** — Define the filter by specifying the frequency for the 3-dB point (IIR designs or maxflat FIR).
- **6dB point** — Define the filter by specifying the frequency for the 6-dB point in the filter response (FIR designs).

Frequency units

Use this parameter to specify whether your frequency settings are normalized or in absolute frequency. Select **Normalized (0–1)** to enter frequencies in normalized form. This behavior is the default. To enter frequencies in absolute values, select one of the frequency units from the drop-down list—Hz, kHz, MHz, or GHz. Selecting one of the unit options enables the **Input Fs** parameter.

Input Fs

Fs, specified in the units you selected for **Frequency units**, defines the sampling frequency at the filter input. When you provide an input sampling frequency, all frequencies in the specifications are in the selected units as well. This parameter is available when you select one of the frequency options from the **Frequency units** list.

Fpass

Enter the frequency at the of the passband. Specify the value in either normalized frequency units or the absolute units you select **Frequency units**.

Fstop

Enter the frequency at the start of the stopband. Specify the value in either normalized frequency units or the absolute units you select **Frequency units**.

Magnitude specifications

The parameters in this group let you specify the filter response in the passbands and stopbands.

Magnitude units

Specify the units for any parameter you provide in magnitude specifications. Select one of the following options from the drop-down list.

- **Linear** — Specify the magnitude in linear units.

- **dB** — Specify the magnitude in decibels (default)
- **Squared** — Specify the magnitude in squared units.

Apass

Enter the filter ripple allowed in the passband in the units you choose for **Magnitude units**, either linear or decibels.

Astop

Enter the filter attenuation in the stopband in the units you choose for **Magnitude units**, either linear or decibels.

Algorithm

The parameters in this group allow you to specify the design method and structure that filterBuilder uses to implement your filter.

Design Method

Lists the design methods available for the frequency and magnitude specifications you entered. When you change the specifications for a filter, such as changing the impulse response, the methods available to design filters changes as well. The default IIR design method is usually Butterworth, and the default FIR method is equiripple.

Scale SOS filter coefficients to reduce chance of overflow

Selecting this parameter directs the design to scale the filter coefficients to reduce the chances that the inputs or calculations in the filter overflow and exceed the representable range of the filter. Clearing this option removes the scaling. This parameter applies only to IIR filters.

Design Options

The options for each design are specific for each design method. This section does not present all of the available options for all designs and design methods. There are many more that you encounter as you select different design methods and filter specifications. The following options represent some of the most common ones available.

Density factor

Density factor controls the density of the frequency grid over which the design method optimization evaluates your filter response function. The number of equally spaced points in the grid is the value you enter for **Density factor** times (filter order + 1).

Increasing the value creates a filter that more closely approximates an ideal equiripple filter but increases the time required to design the filter. The default value of 16 represents a reasonable trade between the accurate approximation to the ideal filter and the time to design the filter.

Phase constraint

This option only applies when you have the DSP System Toolbox software and when the **Design method** is `equiripple`. Select one of `Linear`, `Minimum`, or `Maximum`.

Minimum order — This option only applies when you have the DSP System Toolbox software and the **Order mode** is `Minimum`.

Select `Any` (default), `Even`, or `Odd`. Selecting `Even` or `Odd` forces the minimum-order design to be an even or odd order.

Match Exactly

Specifies that the resulting filter design matches either the passband or stopband when you select `Passband` or `Stopband`.

Stopband Shape

Stopband shape lets you specify how the stopband changes with increasing frequency. Choose one of the following options:

- **Flat** — Specifies that the stopband is flat. The attenuation does not change as the frequency increases.
- **Linear** — Specifies that the stopband attenuation changes linearly as the frequency increases. Change the slope of the stopband by setting **Stopband decay**.
- $1/f$ — Specifies that the stopband attenuation changes exponentially as the frequency increases, where f is the frequency. Set the power (exponent) for the decay in **Stopband decay**.

Stopband Decay

When you set Stopband shape, Stopband decay specifies the amount of decay applied to the stopband. The following conditions apply to Stopband decay based on the value of Stopband Shape:

- When you set **Stopband shape** to `Flat`, **Stopband decay** has no effect on the stopband.
- When you set **Stopband shape** to `Linear`, enter the slope of the stopband in units of dB/rad/s. `filterBuilder` applies that slope to the stopband.

- When you set **Stopband shape** to $1/f$, enter a value for the exponent n in the relation $(1/f)^n$ to define the stopband decay. `filterBuilder` applies the $(1/f)^n$ relation to the stopband to result in an exponentially decreasing stopband attenuation.

Wpass

Passband weight. This option only applies when **Impulse response** is **FIR** and **Order mode** is **Specify**.

Wstop

Stopband weight. This option only applies when **Impulse response** is **FIR** and **Order mode** is **Specify**.

Filter implementation

Structure

For the filter specifications and design method you select, this parameter lists the filter structures available to implement your filter. By default, FIR filters use direct-form structure, and IIR filters use direct-form II filters with SOS.

Use a System object to implement filter

This check box appears when you set **Filter type** to **Single-rate**. Selecting this check box gives you the choice of using a System object to implement the filter. By default, the check box is cleared.

This check box no longer appears when you set **Filter type** to **Interpolator**, **Decimator**, or **Sample-rate converter**. The filter builder always implements the filter as a System object.

Notch

See “Peak/Notch Filter Design — Main Pane” on page 1-764.

Nyquist Filter Design — Main Pane

The image shows a software dialog box titled "Nyquist Design". The main area is labeled "Nyquist Design" and "Design a Nyquist filter." Below this, there is a text field for "Save variable as:" containing "Hnyq" and a "View Filter Response" button. The dialog has three tabs: "Main" (selected), "Data Types", and "Code Generation". The "Main" tab contains several sections:

- Filter specifications:** Includes fields for "Band:" (value: 2), "Impulse response:" (dropdown: FIR), "Filter order mode:" (dropdown: Minimum), and "Filter type:" (dropdown: Single-rate).
- Frequency specifications:** Includes "Frequency units:" (dropdown: Normalized (0 to 1)) and "Transition width:" (value: .1).
- Magnitude specifications:** Includes "Magnitude units:" (dropdown: dB) and "Astop:" (value: 80).
- Algorithm:** Includes "Design method:" (dropdown: Kaiser window).
- Filter implementation:** Includes "Structure:" (dropdown: Direct-form FIR) and a checkbox "Use a System object to implement filter" which is currently unchecked.

At the bottom of the dialog are four buttons: "OK", "Cancel", "Help", and "Apply".

Filter specifications

Parameters in this group enable you to specify your filter format, such as the impulse response and the filter order.

Band

Specifies the location of the center of the transition region between the passband and the stopband. The center of the transition region, `bw`, is calculated using the value for `Band`:

$$bw = Fs/(2 \times Band).$$

Impulse response

Select `FIR` or `IIR` from the drop-down list, where `FIR` is the default impulse response. When you choose an impulse response, the design methods and structures you can use to implement your filter change accordingly.

Note: The design methods and structures for FIR filters are not the same as the methods and structures for IIR filters.

Order mode

Select `Minimum` (the default) or `Specify` from the drop-down list. Selecting `Specify` enables the **Order** option (see the following sections) so you can enter the filter order.

Filter type

Select `Single-rate`, `Decimator`, `Interpolator`, or `Sample-rate converter`. Your choice determines the type of filter as well as the design methods and structures that are available to implement your filter. By default, `filterBuilder` specifies single-rate filters.

- Selecting `Decimator` or `Interpolator` activates the **Decimation Factor** or the **Interpolation Factor** options respectively.
- Selecting `Sample-rate converter` activates both factors.

When you design either a decimator or an interpolator, the resulting filter is a bandpass filter that either decimates or interpolates your input signal.

Order

Enter the filter order. This option is enabled only if `Specify` was selected for **Order mode**.

Decimation Factor

Enter the decimation factor. This option is enabled only if the **Filter type** is set to `Decimator` or `Sample-rate converter`. The default factor value is 2.

Interpolation Factor

Enter the decimation factor. This option is enabled only if the **Filter type** is set to **Interpolator** or **Sample-rate converter**. The default factor value is 2.

Frequency specifications

The parameters in this group allow you to specify your filter response curve. Graphically, the filter specifications look similar to those shown in the following figure.

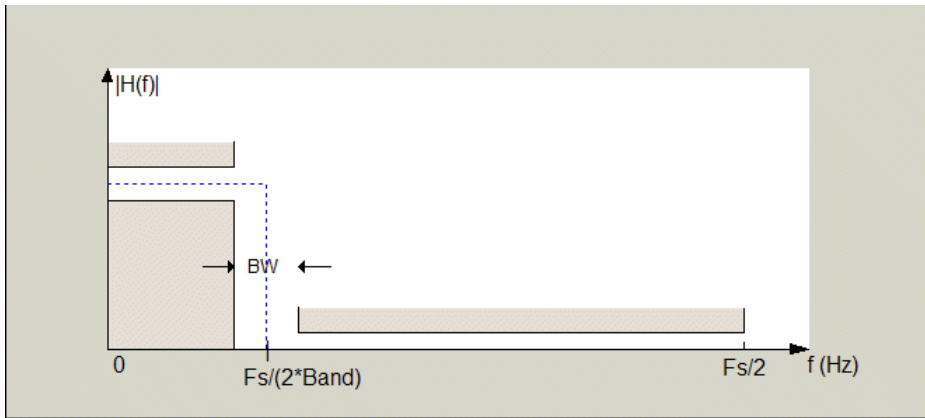

In the figure, BW is the width of the transition region and **Band** determines the location of the center of the region.

Frequency constraints

Select the filter features to use to define the frequency response characteristics. The list contains the following options, when available for the filter specifications.

- **Passband and stopband edges** — Define the filter by specifying the frequencies for the edges for the stopbands and passbands.
- **Passband edges** — Define the filter by specifying frequencies for the edges of the passband.
- **Stopband edges** — Define the filter by specifying frequencies for the edges of the stopbands.
- **3 dB points** — Define the filter response by specifying the locations of the 3 dB points. The 3 dB point is the frequency for the point 3 dB below the passband value.

- **3 dB points and passband width** — Define the filter by specifying frequencies for the 3 dB points in the filter response and the width of the passband.
- **3 dB points and stopband widths** — Define the filter by specifying frequencies for the 3 dB points in the filter response and the width of the stopband.

Frequency units

Use this parameter to specify whether your frequency settings are normalized or in absolute frequency. Select **Normalized (0–1)** to enter frequencies in normalized form. This behavior is the default. To enter frequencies in absolute values, select one of the frequency units from the drop-down list—**Hz**, **KHz**, **MHz**, or **GHz**. Selecting one of the unit options enables the **Input Fs** parameter.

Input Fs

Fs, specified in the units you selected for **Frequency units**, defines the sampling frequency at the filter input. When you provide an input sampling frequency, all frequencies in the specifications are in the selected units as well. This parameter is available when you select one of the frequency options from the **Frequency units** list.

Transition width

Specify the width of the transition between the end of the passband and the edge of the stopband. Specify the value in normalized frequency units or the absolute units you select in **Frequency units**.

Magnitude specifications

The parameters in this group let you specify the filter response in the passbands and stopbands.

Magnitude units

Specify the units for any parameter you provide in magnitude specifications. Select one of the following options from the drop-down list.

- **Linear** — Specify the magnitude in linear units.
- **dB** — Specify the magnitude in decibels (default)
- **Squared** — Specify the magnitude in squared units.

Astop

Enter the filter attenuation in the stopband in the units you choose for **Magnitude units**, either linear or decibels.

Algorithm

The parameters in this group allow you to specify the design method and structure that `filterBuilder` uses to implement your filter.

Design Method

Lists the design methods available for the frequency and magnitude specifications you entered. When you change the specifications for a filter, such as changing the impulse response, the methods available to design filters changes as well. The default IIR design method is usually Butterworth, and the default FIR method is equiripple.

Scale SOS filter coefficients to reduce chance of overflow

Selecting this parameter directs the design to scale the filter coefficients to reduce the chances that the inputs or calculations in the filter overflow and exceed the representable range of the filter. Clearing this option removes the scaling. This parameter applies only to IIR filters.

Design Options

The options for each design are specific for each design method. This section does not present all of the available options for all designs and design methods. There are many more that you encounter as you select different design methods and filter specifications. The following options represent some of the most common ones available.

Density factor

Density factor controls the density of the frequency grid over which the design method optimization evaluates your filter response function. The number of equally spaced points in the grid is the value you enter for **Density factor** times (filter order + 1).

Increasing the value creates a filter that more closely approximates an ideal equiripple filter but increases the time required to design the filter. The default value of 16 represents a reasonable trade between the accurate approximation to the ideal filter and the time to design the filter.

Minimum phase

To design a filter that is minimum phase, select **Minimum phase**. Clearing the **Minimum phase** option removes the phase constraint—the resulting design is not minimum phase.

Minimum order

When you select this parameter, the design method determines and designs the minimum order filter to meet your specifications. Some filters do not provide this parameter. Select **Any**, **Even**, or **Odd** from the drop-down list to direct the design to be any minimum order, or minimum even order, or minimum odd order.

Note: Generally, **Minimum order** designs are not available for IIR filters.

Match Exactly

Specifies that the resulting filter design matches either the passband or stopband or both bands when you select **passband** or **stopband** or **both** from the drop-down list.

Stopband Shape

Stopband shape lets you specify how the stopband changes with increasing frequency. Choose one of the following options:

- **Flat** — Specifies that the stopband is flat. The attenuation does not change as the frequency increases.
- **Linear** — Specifies that the stopband attenuation changes linearly as the frequency increases. Change the slope of the stopband by setting **Stopband decay**.
- **1/f** — Specifies that the stopband attenuation changes exponentially as the frequency increases, where **f** is the frequency. Set the power (exponent) for the decay in **Stopband decay**.

Stopband Decay

When you set Stopband shape, Stopband decay specifies the amount of decay applied to the stopband. the following conditions apply to Stopband decay based on the value of Stopband Shape:

- When you set **Stopband shape** to **Flat**, **Stopband decay** has no affect on the stopband.
- When you set **Stopband shape** to **Linear**, enter the slope of the stopband in units of dB/rad/s. **filterBuilder** applies that slope to the stopband.
- When you set **Stopband shape** to **1/f**, enter a value for the exponent n in the relation $(1/f)^n$ to define the stopband decay. **filterBuilder** applies the

$(1/f)^n$ relation to the stopband to result in an exponentially decreasing stopband attenuation.

Filter implementation

Structure

For the filter specifications and design method you select, this parameter lists the filter structures available to implement your filter. By default, FIR filters use direct-form structure, and IIR filters use direct-form II filters with SOS.

Use a System object to implement filter

This check box appears when you set **Filter type** to **Single-rate**. Selecting this check box gives you the choice of using a System object to implement the filter. By default, the check box is cleared.

This check box no longer appears when you set **Filter type** to **Interpolator**, **Decimator**, or **Sample-rate converter**. The filter builder always implements the filter as a System object.

Octave Filter Design — Main Pane

The screenshot shows the 'Octave Design' dialog box with the following settings:

- Save variable as:
- Filter specifications:
 - Order: 6
 - Bands per octave: 1
 - Frequency units: Hz Input Fs: 48000
 - Center frequency: 1000
- Algorithm:
 - Design method: Butterworth
 - Scale SOS filter coefficients to reduce chance of overflow
- Filter implementation:
 - Structure: Direct-form II SOS
 - Use a System object to implement filter

Buttons at the bottom: OK, Cancel, Help, Apply

Filter specifications

Order

Specify filter order. Possible values are: 4, 6, 8, 10.

Bands per octave

Specify the number of bands per octave. Possible values are: 1, 3, 6, 12, 24.

Frequency units

Specify frequency units as HZ or KHZ.

Input Fs

Specify the input sampling frequency in the frequency units specified previously.

Center Frequency

Select from the drop-down list of available center frequency values.

Algorithm

Design Method

Butterworth is the design method used for this type of filter.

Scale SOS filter coefficients to reduce chance of overflow

Select the check box to scale the filter coefficients.

Filter implementation

Structure

Specify filter structure. Choose from:

- Direct-form I SOS
- Direct-form II SOS
- Direct-form I transposed SOS
- Direct-form II transposed SOS

Use a System object to implement filter

Selecting this check box gives you the choice of using a System object to implement the filter. By default, the check box is cleared. When the current design method or structure is not supported by a system object filter, then this check box is disabled.

Parametric Equalizer Filter Design — Main Pane

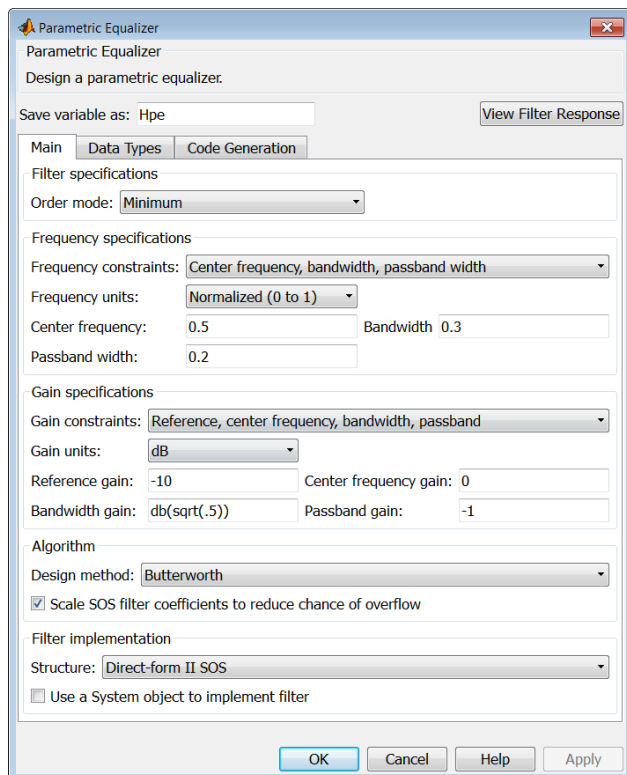

Filter specifications

Order mode

Select **Minimum** to design a minimum order filter that meets the design specifications, or **Specify** to enter a specific filter order. The order mode also affects the possible frequency constraints, which in turn limit the gain specifications. For example, if you specify a **Minimum** order filter, the available frequency constraints are:

- Center frequency, bandwidth, passband width
- Center frequency, bandwidth, stopband width

If you select **Specify**, the available frequency constraints are:

- Center frequency, bandwidth
- Center frequency, quality factor
- Shelf type, cutoff frequency, quality factor
- Shelf type, cutoff frequency, shelf slope parameter
- Low frequency, high frequency

Order

This parameter is enabled only if the **Order mode** is set to **Specify**. Enter the filter order in this text box.

Frequency specifications

Depending on the filter order, the possible frequency constraints change. Once you choose the frequency constraints, the input boxes in this area change to reflect the selection.

Frequency constraints

Select the specification to represent the frequency constraints. The following options are available:

- Center frequency, bandwidth, passband width (available for minimum order only)
- Center frequency, bandwidth, stopband width (available for minimum order only)
- Center frequency, bandwidth (available for a specified order only)
- Center frequency, quality factor (available for a specified order only)
- Shelf type, cutoff frequency, quality factor (available for a specified order only)
- Shelf type, cutoff frequency, shelf slope parameter (available for a specified order only)
- Low frequency, high frequency (available for a specified order only)

Frequency units

Select the frequency units from the available drop down list (**Normalized**, **Hz**, **kHz**, **MHz**, **GHz**). If **Normalized** is selected, then the **Input Fs** box is disabled for input.

Input Fs

Enter the input sampling frequency. This input box is disabled for input if **Normalized** is selected in the **Frequency units** input box.

Center frequency

Enter the center frequency in the units specified by the value in **Frequency units**.

Bandwidth

The bandwidth determines the frequency points at which the filter magnitude is attenuated by the value specified as the **Bandwidth gain** in the **Gain specifications** section. By default, the **Bandwidth gain** defaults to $\text{db}(\text{sqrt}(.5))$, or -3 dB relative to the center frequency. The **Bandwidth** property only applies when the **Frequency constraints** are: **Center frequency, bandwidth, passband width, Center frequency, bandwidth, stopband width, or Center frequency, bandwidth.**

Passband width

The passband width determines the frequency points at which the filter magnitude is attenuated by the value specified as the **Passband gain** in the **Gain specifications** section. This option is enabled only if the filter is of minimum order, and the frequency constraint selected is **Center frequency, bandwidth, passband width.**

Stopband width

The stopband width determines the frequency points at which the filter magnitude is attenuated by the value specified as the **Stopband gain** in the **Gain specifications** section. This option is enabled only if the filter is of minimum order, and the frequency constraint selected is **Center frequency, bandwidth, stopband width.**

Low frequency

Enter the low frequency cutoff. This option is enabled only if the filter order is user specified and the frequency constraint selected is **Low frequency, high frequency.** The filter magnitude is attenuated by the amount specified in **Bandwidth gain.**

High frequency

Enter the high frequency cutoff. This option is enabled only if the filter order is user specified and the frequency constraint selected is **Low frequency, high frequency.** The filter magnitude is attenuated by the amount specified in **Bandwidth gain.**

Gain specifications

Depending on the filter order and frequency constraints, the possible gain constraints change. Also, once you choose the gain constraints the input boxes in this area change to reflect the selection.

Gain constraints

Select the specification array to represent gain constraints, and remember that not all of these options are available for all configurations. The following is a list of all available options:

- Reference, center frequency, bandwidth, passband
- Reference, center frequency, bandwidth, stopband
- Reference, center frequency, bandwidth, passband, stopband
- Reference, center frequency, bandwidth

Gain units

Specify the gain units either **dB** or **squared**. These units are used for all gain specifications in the dialog box.

Reference gain

The reference gain determines the level to which the filter magnitude attenuates in **Gain units**. The reference gain is a *floor* gain for the filter magnitude response. For example, you may use the reference gain together with the **Center frequency gain** to leave certain frequencies unattenuated (reference gain of 0 dB) while boosting other frequencies.

Bandwidth gain

Specifies the gain in **Gain units** at which the bandwidth is defined. This property applies only when the **Frequency constraints** specification contains a **bandwidth** parameter, or is **Low frequency**, **high frequency**.

Center frequency gain

Specify the center frequency in **Gain units**

Passband gain

The passband gain determines the level in **Gain units** at which the passband is defined. The passband is determined either by the **Passband width** value, or the **Low frequency** and **High frequency** values in the **Frequency specifications** section.

Stopband gain

The stopband gain is the level in **Gain units** at which the stopband is defined. This property applies only when the **Order mode** is minimum and the **Frequency constraints** are Center frequency, bandwidth, stopband width.

Boost/cut gain

The boost/cut gain applies only when the designing a shelving filter. Shelving filters include the **Shelf type** parameter in the **Frequency constraints** specification. The gain in the passband of the shelving filter is increased by **Boost/cut gain** dB from a *floor* gain of 0 dB.

Algorithm**Design method**

Select the design method from the drop-down list. Different IIR design methods are available depending on the filter constraints you specify.

Scale SOS filter coefficients to reduce chance of overflow

Select the check box to scale the filter coefficients.

Filter implementation**Structure**

Select filter structure. The possible choices are:

- Direct-form I SOS
- Direct-form II SOS
- Direct-form I transposed SOS
- Direct-form II transposed SOS

Use a System object to implement filter

Selecting this check box gives you the choice of using a System object to implement the filter. By default, the check box is cleared. When the current design method or structure is not supported by a System object filter, then this check box is disabled.

Peak/Notch Filter Design — Main Pane

The screenshot shows the 'Peak/Notch Design' dialog box with the 'Main' tab selected. The dialog is titled 'Peak/Notch Design' and contains the following sections:

- Save variable as:** A text field containing 'Hpn' and a 'View Filter Response' button.
- Filter specifications:** A section with a 'Response' dropdown menu set to 'Peak' and an 'Order' text field set to '6'.
- Frequency specifications:** A section with a 'Frequency constraints' dropdown menu set to 'Center frequency and quality factor', a 'Frequency units' dropdown menu set to 'Normalized (0 to 1)', a 'Center frequency' text field set to '0.5', and a 'Quality factor' text field set to '2.5'.
- Magnitude specifications:** A section with a 'Magnitude constraints' dropdown menu set to 'Unconstrained'.
- Algorithm:** A section with a 'Design method' dropdown menu set to 'Butterworth' and a checked checkbox labeled 'Scale SOS filter coefficients to reduce chance of overflow'.
- Filter implementation:** A section with a 'Structure' dropdown menu set to 'Direct-form II SOS' and an unchecked checkbox labeled 'Use a System object to implement filter'.

At the bottom of the dialog are four buttons: 'OK', 'Cancel', 'Help', and 'Apply'.

Filter specifications

In this area you can specify whether you want to design a peaking filter or a notching filter, as well as the order of the filter.

Response

Select **Peak** or **Notch** from the drop-down box.

Order

Enter the filter order. The order must be even.

Frequency specifications

This group of parameters allows you to specify frequency constraints and units.

Frequency Constraints

Select the frequency constraints for filter specification. There are two choices as follows:

- Center frequency and quality factor
- Center frequency and bandwidth

Frequency units

The frequency units are normalized by default. If you specify units other than normalized, **filterBuilder** assumes that you wish to specify an input sampling frequency, and enables this input box. The choice of frequency units are: Normalized (0 to 1), Hz, kHz, MHz, GHz.

Input Fs

This input box is enabled if **Frequency units** other than Normalized (0 to 1) are specified. Enter the input sampling frequency.

Center frequency

Enter the center frequency in the units you specified in **Frequency units**.

Quality Factor

This input box is enabled only when **Center frequency** and **quality factor** is chosen for the **Frequency Constraints**. Enter the quality factor.

Bandwidth

This input box is enabled only when **Center frequency** and **bandwidth** is chosen for the **Frequency Constraints**. Enter the bandwidth.

Magnitude specifications

This group of parameters allows you to specify the magnitude constraints, as well as their values and units.

Magnitude Constraints

Depending on the choice of constraints, the other input boxes are enabled or disabled. Select from four magnitude constraints available:

- Unconstrained
- Passband ripple
- Stopband attenuation
- Passband ripple and stopband attenuation

Magnitude units

Select the magnitude units: either dB or squared.

Apass

This input box is enabled if the magnitude constraints selected are **Passband ripple** or **Passband ripple and stopband attenuation**. Enter the passband ripple.

Astop

This input box is enabled if the magnitude constraints selected are **Stopband attenuation** or **Passband ripple and stopband attenuation**. Enter the stopband attenuation.

Algorithm

The parameters in this group allow you to specify the design method and structure that `filterBuilder` uses to implement your filter.

Design Method

Lists all design methods available for the frequency and magnitude specifications you entered. When you change the specifications for a filter the methods available to design filters changes as well.

Scale SOS filter coefficients to reduce chance of overflow

Selecting this parameter directs the design to scale the filter coefficients to reduce the chances that the inputs or calculations in the filter overflow and exceed the representable range of the filter. Clearing this option removes the scaling. This parameter applies only to IIR filters.

Filter implementation

Structure

Lists all available filter structures for the filter specifications and design method you select. The typical options are:

- Direct-form I SOS
- Direct-form II SOS
- Direct-form I transposed SOS
- Direct-form II transposed SOS

Use a System object to implement filter

Selecting this check box gives you the choice of using a System object to implement the filter. By default, the check box is cleared. When the current design method or structure is not supported by a System object filter, then this check box is disabled.

Pulse-shaping Filter Design — Main Pane

The screenshot shows the 'Pulse-shaping Design' dialog box with the 'Main' tab selected. The dialog is titled 'Pulse-shaping Design' and contains the following sections and controls:

- Save variable as:** A text field containing 'Hps'.
- View Filter Response:** A button.
- Filter specifications:**
 - Pulse shape:** A dropdown menu set to 'Raised Cosine'.
 - Order mode:** A dropdown menu set to 'Minimum'.
 - Samples per symbol:** A text field containing '8'.
 - Filter type:** A dropdown menu set to 'Single-rate'.
- Frequency specifications:**
 - Rolloff factor:** A text field containing '.5'.
 - Frequency units:** A dropdown menu set to 'Normalized (0 to 1)'.
- Magnitude specifications:**
 - Magnitude units:** A dropdown menu set to 'dB'.
 - Astop:** A text field containing '50'.
- Algorithm:**
 - Design method:** A dropdown menu set to 'Window'.
- Filter implementation:**
 - Structure:** A dropdown menu set to 'Direct-form FIR'.
 - Use a System object to implement filter

At the bottom of the dialog are four buttons: 'OK', 'Cancel', 'Help', and 'Apply'.

Filter specifications

Parameters in this group enable you to specify the shape and length of the filter.

Pulse shape

Select the shape of the impulse response from the following options:

- Raised Cosine
- Square Root Raised Cosine
- Gaussian

Order mode

This specification is only available for raised cosine and square root raised cosine filters. For these filters, select one of the following options:

- **Minimum**— This option will result in the minimum-length filter satisfying the user-specified **Frequency specifications**.
- **Specify order**—This option allows the user to construct a raised cosine or square root cosine filter of a specified order by entering an even number in the **Order** input box. The length of the impulse response will be **Order+1**.
- **Specify symbols**—This option enables the user to specify the length of the impulse response in an alternative manner. If **Specify symbols** is chosen, the **Order** input box changes to the **Number of symbols** input box.

Samples per symbol

Specify the oversampling factor. Increasing the oversampling factor guards against aliasing and improves the FIR filter approximation to the ideal frequency response. If **Order** is specified in **Number of symbols**, the filter length will be **Number of symbols*Samples per symbol+1**. The product **Number of symbols*Samples per symbol** must be an even number.

If a Gaussian filter is specified, the filter length must be specified in **Number of symbols** and **Samples per symbol**. The product **Number of symbols*Samples per symbol** must be an even number. The filter length will be **Number of symbols*Samples per symbol+1**.

Filter Type

This option is only available if you have the DSP System Toolbox software. Choose **Single rate**, **Decimator**, **Interpolator**, or **Sample-rate converter**. If you select **Decimator** or **Interpolator**, the decimation and interpolation factors default to the value of the **Samples per symbol**. If you select **Sample-rate converter**, the interpolation factor defaults to **Samples per symbol** and the decimation factor defaults to 3.

Frequency specifications

Parameters in this group enable you to specify the frequency response of the filter. For raised cosine and square root raised cosine filters, the frequency specifications include:

Rolloff factor

The rolloff factor takes values in the range [0,1]. The smaller the rolloff factor, the steeper the transition in the stopband.

Frequency units

The frequency units are normalized by default. If you specify units other than normalized, `filterBuilder` assumes that you wish to specify an input sampling frequency, and enables this input box. The choice of frequency units are: Normalized (0 to 1), Hz, kHz, MHz, GHz

For a Gaussian pulse shape, the available frequency specifications are:

Bandwidth-time product

This option allows the user to specify the width of the Gaussian filter. Note that this is independent of the length of the filter. The bandwidth-time product (BT) must be a positive real number. Smaller values of the bandwidth-time product result in larger pulse widths in time and steeper stopband transitions in the frequency response.

Frequency units

The frequency units are normalized by default. If you specify units other than normalized, `filterBuilder` assumes that you wish to specify an input sampling frequency, and enables this input box. The choice of frequency units are: Normalized (0 to 1), Hz, kHz, MHz, GHz

Magnitude specifications

If the **Order mode** is specified as Minimum, the **Magnitude units** may be selected from:

- dB— Specify the magnitude in decibels (default).
- Linear— Specify the magnitude in linear units.

Algorithm

The only **Design method** available for FIR pulse-shaping filters is the `Window` method.

Filter implementation

Structure

For the filter specifications and design method you select, this parameter lists the filter structures available to implement your filter. By default, FIR filters use direct-form structure.

Use a System object to implement filter

This check box appears when you set **Filter type** to **Single-rate**. Selecting this check box gives you the choice of using a System object to implement the filter. By default, the check box is cleared.

This check box no longer appears when you set **Filter type** to **Interpolator**, **Decimator**, or **Sample-rate converter**. The filter builder always implements the filter as a System object.

Introduced in R2009a

Filter Designer

Design filters starting with algorithm selection

Description

The **Filter Designer** app enables you to design and analyze digital filters. You can also import and modify existing filter designs.

If the DSP System Toolbox product is installed, **Filter Designer** integrates advanced filter design methods and the ability to quantize filters. For more information, see the DSP System Toolbox documentation.

Note: This app requires a screen resolution greater than 640 × 480.

Open the Filter Designer App

- MATLAB Toolstrip: On the **Apps** tab, under **Signal Processing and Communications**, click the app icon.
- MATLAB command prompt: Enter `filterDesigner`.

Examples

- “Getting Started with Filter Designer”
- “FIR Bandpass Filter with Asymmetric Attenuation”
- “Arbitrary Magnitude Filter”

See Also

See Also

Apps

Signal Analyzer | Window Designer

Functions

designfilt | fvtool | sptool | wvtool

Topics

“Getting Started with Filter Designer”

“FIR Bandpass Filter with Asymmetric Attenuation”

“Arbitrary Magnitude Filter”

Introduced before R2006a

filternorm

2-norm or infinity-norm of digital filter

Syntax

```
L = filternorm(b,a)
L = filternorm(b,a,pnorm)
L = filternorm(b,a,2,tol)
```

Description

A typical use for filter norms is in digital filter scaling to reduce quantization effects. Scaling often improves the signal-to-noise ratio of the filter without resulting in data overflow. You also can use the 2-norm to compute the energy of the impulse response of a filter.

`L = filternorm(b,a)` computes the 2-norm of the digital filter defined by the numerator coefficients in `b` and denominator coefficients in `a`.

`L = filternorm(b,a,pnorm)` computes the 2- or infinity-norm (inf-norm) of the digital filter, where `pnorm` is either `2` or `inf`.

`L = filternorm(b,a,2,tol)` computes the 2-norm of an IIR filter with the specified tolerance, `tol`. The tolerance can be specified only for IIR 2-norm computations. `pnorm` in this case must be `2`. If `tol` is not specified, it defaults to 10^{-8} .

Examples

Filter Norms

Compute the 2-norm of a Butterworth IIR filter with tolerance 10^{-10} . Specify a normalized cutoff frequency of 0.5π rad/s and a filter order of 5.

```
[b,a] = butter(5,0.5);
L2 = filternorm(b,a,2,1e-10)
```

```
L2 = 0.7071
```

Compute the infinity-norm of an FIR Hilbert transformer of order 30 and normalized transition width 0.2π rad/s.

```
b = firpm(30,[.1 .9],[1 1], 'Hilbert');
Linf = filternorm(b,1,inf)
```

```
Linf = 1.0028
```

Algorithms

Given a filter with frequency response $H(e^{j\omega})$, the L_p -norm for $1 \leq p < \infty$ is given by

$$\|H(e^{j\omega})\|_p = \left(\frac{1}{2\pi} \int_{-\pi}^{\pi} |H(e^{j\omega})|^p d\omega \right)^{1/p}.$$

For the case $p \rightarrow \infty$, the L_∞ -norm is

$$\|H(e^{j\omega})\|_\infty = \max_{-\pi \leq \omega \leq \pi} |H(e^{j\omega})|.$$

For the case $p = 2$, Parseval's theorem states that

$$\|H(e^{j\omega})\|_2 = \left(\frac{1}{2\pi} \int_{-\pi}^{\pi} |H(e^{j\omega})|^2 d\omega \right)^{1/2} = \left(\sum_n |h(n)|^2 \right)^{1/2},$$

where $h(n)$ is the impulse response of the filter. The energy of the impulse response is the squared L_2 -norm.

References

- [1] Jackson, L. B. *Digital Filters and Signal Processing: with MATLAB Exercises*. 3rd Ed. Hingham, MA: Kluwer Academic Publishers, 1996, Chapter 11.

See Also

zp2sos | norm

Introduced before R2006a

filtfilt

Zero-phase digital filtering

Syntax

```
y = filtfilt(b,a,x)
y = filtfilt(SOS,G,x)
y = filtfilt(d,x)
```

Description

`y = filtfilt(b,a,x)` performs zero-phase digital filtering by processing the input data, `x`, in both the forward and reverse directions [1]. `filtfilt` operates along the first nonsingleton dimension of `x`. The vector `b` provides the numerator coefficients of the filter and the vector `a` provides the denominator coefficients. If you use an all-pole filter, enter 1 for `b`. If you use an all-zero filter (FIR), enter 1 for `a`. After filtering the data in the forward direction, `filtfilt` reverses the filtered sequence and runs it back through the filter. The result has the following characteristics:

- Zero-phase distortion
- A filter transfer function, which equals the squared magnitude of the original filter transfer function
- A filter order that is double the order of the filter specified by `b` and `a`

`filtfilt` minimizes start-up and ending transients by matching initial conditions, and you can use it for both real and complex inputs. Do not use `filtfilt` with differentiator and Hilbert FIR filters, because the operation of these filters depends heavily on their phase response.

Note: The length of the input `x` must be more than three times the filter order, defined as $\max(\text{length}(b) - 1, \text{length}(a) - 1)$.

`y = filtfilt(SOS,G,x)` zero-phase filters the data, `x`, using the second-order section (biquad) filter represented by the matrix `SOS` and scale values `G`. `SOS` is an L -by-6 matrix containing the L second-order sections. `SOS` must be of the form

$$\begin{pmatrix} b_{01} & b_{11} & b_{21} & a_{01} & a_{11} & a_{21} \\ b_{02} & b_{12} & b_{22} & a_{02} & a_{12} & a_{22} \\ \vdots & \vdots & \vdots & \vdots & \vdots & \vdots \\ b_{0L} & b_{1L} & b_{2L} & a_{0L} & a_{1L} & a_{2L} \end{pmatrix}$$

where each row are the coefficients of a biquad filter. The vector of filter scale values, \mathbf{G} , must have a length between 1 and $L + 1$.

Note: When implementing zero-phase filtering using a second-order section filter, the length of the input, \mathbf{x} , must be more than three times the filter order. You can use `filtord` to obtain the order of the filter.

`y = filtfilt(d,x)` zero-phase filters the input data, \mathbf{x} , using a digital filter, \mathbf{d} . Use `designfilt` to generate \mathbf{d} based on frequency-response specifications.

Examples

Zero-Phase Filtering of an Electrocardiogram Waveform

Zero-phase filtering helps preserve features in a filtered time waveform exactly where they occur in the unfiltered signal.

To illustrate the use of `filtfilt` for zero-phase filtering, consider an electrocardiogram waveform.

```
wform = ecg(500);  
  
plot(wform)  
axis([0 500 -1.25 1.25])  
text(155,-0.4,'Q')  
text(180,1.1,'R')  
text(205,-1,'S')
```

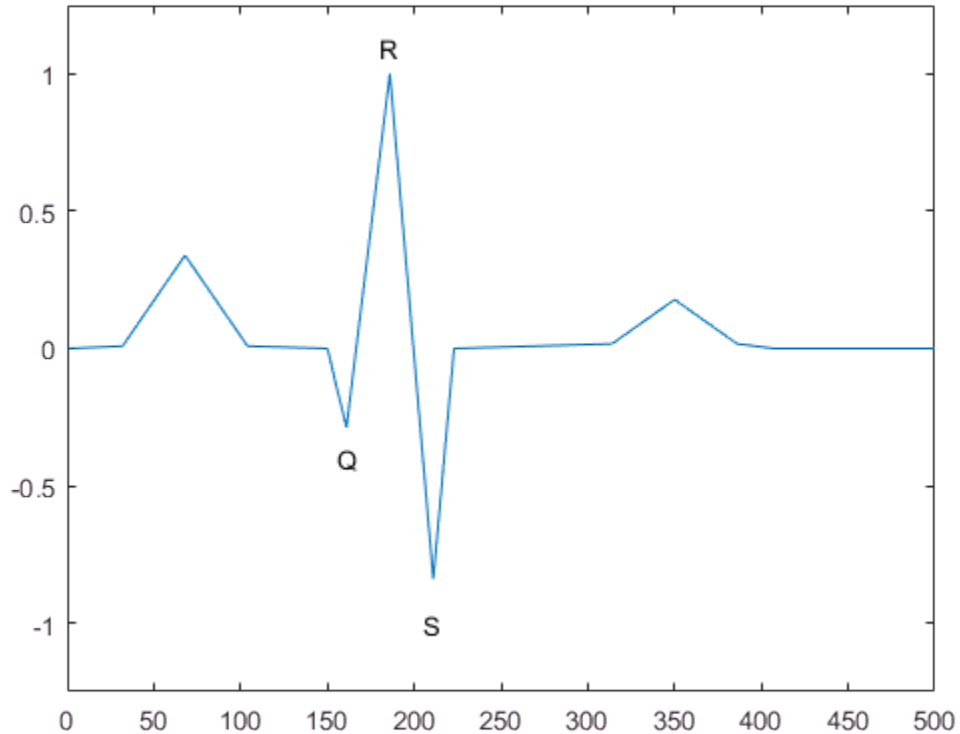
The QRS complex is an important feature in the ECG. Here it begins around time point 160.

Corrupt the ECG with additive noise. Reset the random number generator for reproducible results. Construct a lowpass FIR equiripple filter and filter the noisy waveform using both zero-phase and conventional filtering.

```
rng default

x = wform' + 0.25*randn(500,1);
d = designfilt('lowpassfir', ...
    'PassbandFrequency',0.15,'StopbandFrequency',0.2, ...
    'PassbandRipple',1,'StopbandAttenuation',60, ...
    'DesignMethod','equiripple');
```

```

y = filtfilt(d,x);
y1 = filter(d,x);

subplot(2,1,1)
plot([y y1])
title('Filtered Waveforms')
legend('Zero-phase Filtering', 'Conventional Filtering')

subplot(2,1,2)
plot(wform)
title('Original Waveform')

```



Zero-phase filtering reduces noise in the signal and preserves the QRS complex at the same time it occurs in the original. Conventional filtering reduces noise in the signal, but delays the QRS complex.

Repeat the above using a Butterworth second-order section filter.

```
d1 = designfilt('lowpassiir','FilterOrder',12, ...
               'HalfPowerFrequency',0.15,'DesignMethod','butter');
y = filtfilt(d1,x);

subplot(1,1,1)
plot(x)
hold on
plot(y,'LineWidth',3)
legend('Noisy ECG','Zero-Phase Filtering')
```

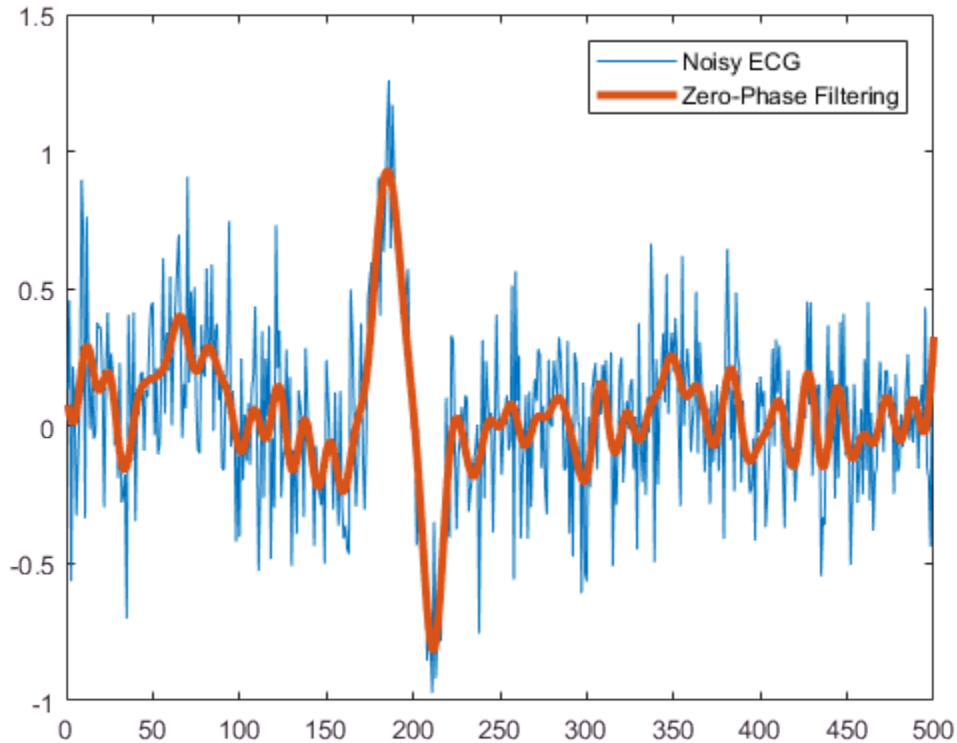

References

- [1] Oppenheim, Alan V., Ronald W. Schafer, and John R. Buck. *Discrete-Time Signal Processing*. 2nd Ed. Upper Saddle River, NJ: Prentice Hall, 1999.
- [2] Mitra, Sanjit K. *Digital Signal Processing*. 2nd Ed. New York: McGraw-Hill, 2001, secs. 4.4.2 and 8.2.5.
- [3] Gustafsson, F. "Determining the initial states in forward-backward filtering." *IEEE Transactions on Signal Processing*. Vol. 44, April 1996, pp. 988–992.

Extended Capabilities

C/C++ Code Generation

Generate C and C++ code using MATLAB® Coder™.

Usage notes and limitations:

All inputs must be constants. Expressions or variables are allowed if their values do not change.

Code generation does not support second-order sections as input. You must use transfer functions.

See Also

`designfilt` | `digitalFilter` | `fftfilt` | `filter` | `filter2`

Introduced before R2006a

filtic

Initial conditions for transposed direct-form II filter implementation

Syntax

```
z = filtic(b,a,y,x)
z = filtic(b,a,y)
```

Description

`z = filtic(b,a,y,x)` finds the initial conditions, `z`, for the delays in the *transposed direct-form II* filter implementation given past outputs `y` and inputs `x`. The vectors `b` and `a` represent the numerator and denominator coefficients, respectively, of the filter's transfer function.

The vectors `x` and `y` contain the most recent input or output first, and oldest input or output last.

$$x = [x(-1), x(-2), x(-3), \dots, x(-n)]$$
$$y = [y(-1), y(-2), y(-3), \dots, y(-m)]$$

where `n` is `length(b) - 1` (the numerator order) and `m` is `length(a) - 1` (the denominator order). If `length(x)` is less than `n`, `filtic` pads it with zeros to length `n`; if `length(y)` is less than `m`, `filtic` pads it with zeros to length `m`. Elements of `x` beyond `x(n-1)` and elements of `y` beyond `y(m-1)` are unnecessary so `filtic` ignores them.

Output `z` is a column vector of length equal to the larger of `n` and `m`. `z` describes the state of the delays given past inputs `x` and past outputs `y`.

`z = filtic(b,a,y)` assumes that the input `x` is 0 in the past.

The transposed direct-form II structure is shown in the following illustration.

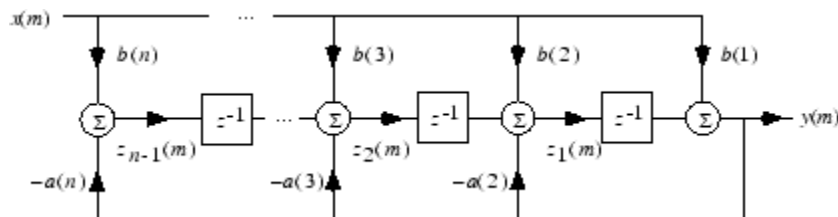

$n - 1$ is the filter order.

`filtic` works for both real and complex inputs.

Diagnostics

If any of the input arguments `y`, `x`, `b`, or `a` is not a vector (that is, if any argument is a scalar or array), `filtic` gives the following error message:

Requires vector inputs.

Algorithms

`filtic` performs a reverse difference equation to obtain the delay states `z`.

References

- [1] Oppenheim, A.V., and R.W. Schaffer, *Discrete-Time Signal Processing*, Prentice-Hall, 1989, pp.296, 301-302.

See Also

`filter` | `filtfilt`

Introduced before R2006a

filtord

Filter order

Syntax

```
n = filtord(b,a)
n = filtord(sos)
n = filtord(d)
```

Description

`n = filtord(b,a)` returns the filter order, `n`, for the causal rational system function specified by the numerator coefficients, `b`, and denominator coefficients, `a`.

`n = filtord(sos)` returns the filter order for the filter specified by the second-order sections matrix, `sos`. `sos` is a K -by-6 matrix. The number of sections, K , must be greater than or equal to 2. Each row of `sos` corresponds to the coefficients of a second-order filter. The i th row of the second-order section matrix corresponds to `[bi(1) bi(2) bi(3) ai(1) ai(2) ai(3)]`.

`n = filtord(d)` returns the filter order, `n`, for the digital filter, `d`. Use the function `designfilt` to generate `d`.

Examples

Verify Order of FIR Filter

Design a 20th-order FIR filter with normalized cutoff frequency 0.5π rad/sample using the window method. Verify the filter order.

```
b = fir1(20,0.5);
n = filtord(b)

n = 20
```

Design the same filter using `designfilt` and verify its order.

```
di = designfilt('lowpassfir', 'FilterOrder', 20, 'CutoffFrequency', 0.5);
ni = filtord(di)

ni = 20
```

Determine the Order Difference Between FIR and IIR Designs

Design FIR equiripple and IIR Butterworth filters from the same set of specifications. Determine the difference in filter order between the two designs.

```
fir = designfilt('lowpassfir', 'DesignMethod', 'equiripple', 'SampleRate', 1e3, ...
                'PassbandFrequency', 100, 'StopbandFrequency', 120, ...
                'PassbandRipple', 0.5, 'StopbandAttenuation', 60);
iir = designfilt('lowpassiir', 'DesignMethod', 'butter', 'SampleRate', 1e3, ...
                'PassbandFrequency', 100, 'StopbandFrequency', 120, ...
                'PassbandRipple', 0.5, 'StopbandAttenuation', 60);
FIR = filtord(fir)

FIR = 114

IIR = filtord(iir)

IIR = 41
```

Input Arguments

b — Numerator coefficients

vector | scalar

Numerator coefficients, specified as a scalar or a vector. If the filter is an allpole filter, **b** is a scalar. Otherwise, **b** is a row or column vector.

Example: `b = fir1(20,0.25)`

Data Types: `single` | `double`

Complex Number Support: Yes

a — Denominator coefficients

vector | scalar

Denominator coefficients, specified as a scalar or a vector. If the filter is an FIR filter, **a** is a scalar. Otherwise, **a** is a row or column vector.

Example: `[b, a] = butter(20, 0.25)`

Data Types: `single` | `double`

Complex Number Support: Yes

sos — Matrix of second-order sections

matrix

Matrix of second order-sections, specified as a K -by-6 matrix. The system function of the K th biquad filter has the rational Z -transform

$$H_k(z) = \frac{B_k(1) + B_k(2)z^{-1} + B_k(3)z^{-2}}{A_k(1) + A_k(2)z^{-1} + A_k(3)z^{-2}}.$$

The coefficients in the K th row of the matrix, **sos**, are ordered as follows.

$$[B_k(1) \ B_k(2) \ B_k(3) \ A_k(1) \ A_k(2) \ A_k(3)].$$

The frequency response of the filter is the system function evaluated on the unit circle with

$$z = e^{j2\pi f}.$$

Data Types: `single` | `double`

Complex Number Support: Yes

d — Digital filter

`digitalFilter` object

Digital filter, specified as a `digitalFilter` object. Use `designfilt` to generate a digital filter based on frequency-response specifications.

Example: `d =`

`designfilt('lowpassiir', 'FilterOrder', 3, 'HalfPowerFrequency', 0.5)`

specifies a third-order Butterworth filter with normalized 3-dB frequency 0.5π rad/sample.

Output Arguments

n — Filter order

integer

Filter order, specified as an integer.

See Also

See Also

`digitalFilter` | `designfilt` | `isallpass` | `ismaxphase` | `isminphase` | `isstable`

Introduced in R2013a

filtstates

Filter states

Syntax

```
Hs = filtstates.structure(input1,...)
```

Description

`Hs = filtstates.structure(input1,...)` returns a filter states object `Hs`, which contains the filter states.

You can extract a `filtstates` object from the `states` property of an object with

```
Hd = dfilt.df1  
Hs = Hd.states
```

Structures

Structures for `filtstates` specify the type of filter structure. Available types of structures for `filtstates` are shown below.

<code>filtstates.structure</code>	Description
<code>filtstates.dfir</code>	filtstates for IIR direct-form I filters (<code>dfilt.df1</code> , <code>dfilt.df1t</code> , <code>dfilt.df1sos</code> , and <code>dfilt.df1tsos</code>)
<code>filtstates.cic</code>	filtstates for cascaded integrator comb filters. (Available only with DSP System Toolbox and Fixed-Point Designer products.)

Refer to the particular `filtstates.structure` reference page or use the syntax `help filtstates.structure` at the MATLAB prompt for more information.

See Also

`filtstates.dfir` | `dfilt` | `dfilt.df1` | `dfilt.df1t` | `dfilt.df1sos` | `dfilt.df1tsos`

Introduced before R2006a

filtstates.dfiir

IIR direct-form filter states

Syntax

```
Hs = filtstates.dfiir(numstates,denstates)
```

Description

`Hs = filtstates.dfiir(numstates,denstates)` returns an IIR direct-form filter states object `HS` with two properties — `Numerator` and `Denominator`, which contain the filter states. These two properties are column vectors with each column representing a separate channel of filter states. The number of states is always one less than the number of filter numerator or denominator coefficients.

You can extract a `filtstates` object from the `states` property of an IIR direct-form `I` object with

```
Hd = dfilt.df1  
Hs = Hd.states
```

Methods

You can use the following methods on a `filtstates.dfiir` object.

Method	Description
<code>double</code>	Converts a <code>filtstates</code> object to a double-precision vector containing the values of the numerator and denominator states. The numerator states are listed first in this vector, followed by the denominator states.
<code>single</code>	Converts a <code>filtstates</code> object to a single-precision vector containing the values of the numerator and denominator states. (This method is used with the DSP System Toolbox product.)

Examples

This example demonstrates the interaction of `filtstates` with a `dfilt.df1` object.

```
[b,a] = butter(4,0.5);    % Design butterworth filter
Hd = dfilt.df1(b,a);     % Create dfilt object
Hs = Hd.states           % Extract filter states object
                        % from dfilt states property
Hs.Numerator = [1,1,1,1] % Modify numerator states
Hd.states = Hs           % Set modified states back to
                        % original object

Dbl = double(Hs)         % Create double vector from
                        % states
```

See Also

`filtstates` | `dfilt` | `dfilt.df1` | `dfilt.df1t` | `dfilt.df1sos` | `dfilt.df1tsos`

Introduced before R2006a

filt2block

Generate Simulink filter block

Syntax

```
filt2block(b)  
filt2block(b, 'subsystem')  
filt2block( ____, 'FilterStructure', structure)
```

```
filt2block(b, a)  
filt2block(b, a, 'subsystem')  
filt2block( ____, 'FilterStructure', structure)
```

```
filt2block(sos)  
filt2block(sos, 'subsystem')  
filt2block( ____, 'FilterStructure', structure)
```

```
filt2block(d)  
filt2block(d, 'subsystem')  
filt2block( ____, 'FilterStructure', structure)
```

```
filt2block( ____, Name, Value)
```

Description

`filt2block(b)` generates a **Discrete FIR Filter** block with filter coefficients, `b`.

`filt2block(b, 'subsystem')` generates a Simulink subsystem block that implements an FIR filter using sum, gain, and delay blocks.

`filt2block(____, 'FilterStructure', structure)` specifies the filter structure for the FIR filter.

`filt2block(b, a)` generates a **Discrete Filter** block with numerator coefficients, `b`, and denominator coefficients, `a`.

`filt2block(b,a,'subsystem')` generates a Simulink subsystem block that implements an IIR filter using sum, gain, and delay blocks.

`filt2block(____,'FilterStructure',structure)` specifies the filter structure for the IIR filter.

`filt2block(sos)` generates a **Biquad Filter** block with second order sections matrix, `sos`. `sos` is a K-by-6 matrix, where the number of sections, K, must be greater than or equal to 2. You must have the DSP System Toolbox software installed to use this syntax.

`filt2block(sos,'subsystem')` generates a Simulink subsystem block that implements a biquad filter using sum, gain, and delay blocks.

`filt2block(____,'FilterStructure',structure)` specifies the filter structure for the biquad filter.

`filt2block(d)` generates a Simulink block that implements a digital filter, `d`. Use the function `designfilt` to create `d`. The block is a **Discrete FIR Filter** block if `d` is FIR and a **Biquad Filter** block if `d` is IIR.

`filt2block(d,'subsystem')` generates a Simulink subsystem block that implements `d` using sum, gain, and delay blocks.

`filt2block(____,'FilterStructure',structure)` specifies the filter structure to implement `d`.

`filt2block(____,Name,Value)` uses additional options specified by one or more `Name,Value` pair arguments.

Examples

Generate Block from FIR Filter

Design a 30th-order FIR filter using the window method. Specify a cutoff frequency of $\pi/4$ rad/sample. Create a Simulink® block.

```
b = fir1(30,0.25);  
filt2block(b)
```

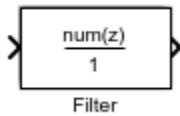

Generate Block from IIR Filter

Design a 30th-order IIR Butterworth filter. Specify a cutoff frequency of $\pi/4$ rad/sample. Create a Simulink® block.

```
[b,a] = butter(30,0.25);
filt2block(b,a)
```

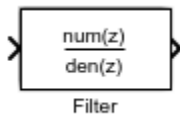

Generate FIR Filter with Direct Form I Transposed Structure

Design a 30th-order FIR filter using the window method. Specify a cutoff frequency of $\pi/4$ rad/sample. Create a Simulink® block with a direct form I transposed structure.

```
b = fir1(30,0.25);
filt2block(b, 'FilterStructure', 'directFormTransposed')
```

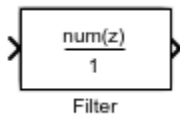

Generate IIR Filter with Direct Form I Structure

Design a 30th-order IIR Butterworth filter. Specify a cutoff frequency of $\pi/4$ rad/sample. Create a Simulink® block with a direct form I structure.

```
[b,a] = butter(30,0.25);
filt2block(b,a, 'FilterStructure', 'directForm1')
```

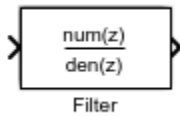

Generate Subsystem Block from Second-Order Section Matrix

Design a 5-th order Butterworth filter with a cutoff frequency of $\pi/5$ rad/sample. Obtain the filter in biquad form and generate a Simulink® subsystem block from the second order sections.

```
[z,p,k] = butter(5,0.2);
sos = zp2sos(z,p,k);
filt2block(sos,'subsystem')
```

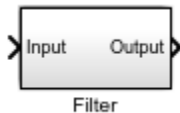

Lowpass FIR Filter Block with Sample-Based Processing

Generate a Simulink® subsystem block that implements an FIR lowpass filter using sum, gain, and delay blocks. Specify the input processing to be elements as channels by specifying 'FrameBasedProcessing' as false.

```
B = fir1(30,.25);
filt2block(B,'subsystem','BlockName','Lowpass FIR',...
'FrameBasedProcessing',false)
```

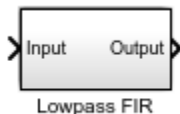

New Model with Highpass Elliptic Filter Block

Design a highpass elliptic filter with normalized stopband frequency 0.45 and normalized passband frequency 0.55. Specify a stopband attenuation of 40. Design a highpass elliptic filter with normalized stopband frequency 0.45 and normalized passband frequency 0.55.

Specify a stopband attenuation of 40 dB and a passband ripple of 0.5 dB. Implement the filter as a Direct Form II structure, call it "HP", and place it in a new Simulink® model.

```
d = designfilt('highpassiir','DesignMethod','ellip', ...
              'StopbandFrequency',0.45,'PassbandFrequency',0.55, ...
              'StopbandAttenuation',40,'PassbandRipple',0.5);

filt2block(d,'subsystem','FilterStructure','directForm2', ...
           'Destination','new','BlockName','HP')
```

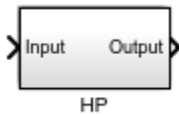

Input Arguments

b — Numerator filter coefficients

row or column vector

Numerator filter coefficients, specified as a row or column vector. The filter coefficients are ordered in descending powers of z^{-1} with the first element corresponding to the coefficient for z^0 .

Example: `b = fir1(30,0.25);`

Data Types: `single` | `double`

Complex Number Support: Yes

a — Denominator filter coefficients

row or column vector

Denominator filter coefficients, specified as a row or column vector. The filter coefficients are ordered in descending powers of z^{-1} with the first element corresponding to the coefficient for z^0 . The first filter coefficient must be 1.

Data Types: `single` | `double`

Complex Number Support: Yes

sos — Second-order section matrix

K -by-2 matrix

Second order section matrix, specified as a K -by-2 matrix. Each row of the matrix contains the coefficients for a biquadratic rational function in z^{-1} . The Z-transform of the K th rational biquadratic system impulse response is

$$H_k(z) = \frac{B_k(1) + B_k(2)z^{-1} + B_k(3)z^{-2}}{A_k(1) + A_k(2)z^{-1} + A_k(3)z^{-2}}$$

The coefficients in the K th row of the matrix, `sos`, are ordered as follows:

$$[B_k(1) \ B_k(2) \ B_k(3) \ A_k(1) \ A_k(2) \ A_k(3)]$$

The frequency response of the filter is its transfer function evaluated on the unit circle with $z = e^{j2\pi f}$.

Data Types: `single` | `double`

Complex Number Support: Yes

d — Digital filter

`digitalFilter` object

Digital filter, specified as a `digitalFilter` object. Use `designfilt` to generate a digital filter based on frequency-response specifications.

Example: `d =`

`designfilt('lowpassiir','FilterOrder',3,'HalfPowerFrequency',0.5)`
specifies a third-order Butterworth filter with normalized 3-dB frequency 0.5π rad/sample.

structure — Filter structure

character vector

Filter structure, specified as a character vector. Valid options for `structure` depend on the input arguments. The following table lists the valid filter structures by input.

Input	Filter Structures
<code>b</code>	'directForm' (default), 'directFormTransposed', 'directFormSymmetric', 'directFormAntiSymmetric', 'overlapAdd'. The 'overlapAdd' structure is only available when you omit

Input	Filter Structures
	'subsystem' and requires a DSP System Toolbox software license.
a	'directForm2' (default), 'directForm1', 'directForm1Transposed', 'directForm2', 'directForm2Transposed'
sos	'directForm2Transposed' (default), 'directForm1', 'directForm1Transposed', 'directForm2'
d	<ul style="list-style-type: none"> • For FIR filters: 'directForm' (default), 'directFormTransposed', 'directFormSymmetric', 'directFormAntiSymmetric', 'overlapAdd'. The 'overlapAdd' structure is only available when you omit 'subsystem' and requires a DSP System Toolbox software license. • For IIR filters: 'directForm2Transposed' (default), 'directForm1', 'directForm1Transposed', 'directForm2'

Name-Value Pair Arguments

Specify optional comma-separated pairs of **Name**, **Value** arguments. **Name** is the argument name and **Value** is the corresponding value. **Name** must appear inside single quotes (' '). You can specify several name and value pair arguments in any order as **Name1**, **Value1**, ..., **NameN**, **ValueN**.

Example: `filt2block(..., 'subsystem', 'BlockName', 'Lowpass FIR', 'FrameBasedProcessing', false)`

'Destination' — Destination for Simulink filter block

'current' (default) | 'new' | user-defined character vector

Destination for the Simulink filter block, specified as a character vector. You can add the filter block to your current model with `'current'`, add the filter block to a new model with `'new'`, or specify the name of an existing model.

```
Example: filt2block([1 2 1], 'Destination', 'MyModel', 'BlockName', 'New  
block')
```

Data Types: `char`

'BlockName' — Block name

character vector

Block name, specified as a character vector.

Data Types: `char`

'OverwriteBlock' — Overwrite block

`false` (default) | `true`

Overwrite block, specified as a logical `false` or `true`. If you use a value for `'BlockName'` that is the same as an existing block, the value of `'OverwriteBlock'` determines whether the block is overwritten. The default value is `false`.

Data Types: `logical`

'MapCoefficientsToPorts' — Map coefficients to ports

`false` (default) | `true`

Map coefficients to ports, specified as a logical `false` or `true`.

Data Types: `logical`

'CoefficientNames' — Coefficient variable names

cell array of character vectors

Coefficient variable names, specified as a cell array of character vectors. This name-value pair is only applicable when `'MapCoefficientsToPorts'` is `true`. The default values are `{'Num'}`, `{'Num', 'Den'}`, and `{'Num', 'Den', 'g'}` for FIR, IIR, and biquad filters.

Data Types: `cell`

'FrameBasedProcessing' — Frame-based or sample-based processing

`true` (default) | `false`

Frame-based or sample-based processing, specified as a logical `true` or `false`. The default is `true` and frame-based processing is used.

Data Types: `logical`

'OptimizeZeros' — Remove zero-gain blocks

`true` (default) | `false`

Remove zero-gain blocks, specified as a logical `true` or `false`. By default zero-gain blocks are removed.

Data Types: `logical`

'OptimizeOnes' — Replace unity-gain blocks with direct connection

`true` (default) | `false`

Replace unity-gain blocks with direct connection, specified as a logical `true` or `false`. The default is `true`.

Data Types: `logical`

'OptimizeNegativeOnes' — Replace negative unity-gain blocks with sign change

`true` (default) | `false`

Replace negative unity-gain blocks with a sign change at the nearest block, specified as a logical `true` or `false`. The default is `true`.

Data Types: `logical`

'OptimizeDelayChains' — Replace cascaded delays with a single delay

`true` (default) | `false`

Replace cascaded delays with a single delay, specified as a logical `true` or `false`. The default is `true`.

Data Types: `logical`

See Also

See Also

`digitalFilter` | `designfilt` | `realizemdl`

Introduced in R2013a

findchangepts

Find abrupt changes in signal

Syntax

```
ipt = findchangepts(x)
ipt = findchangepts(x,Name,Value)

[ipt,residual] = findchangepts( ___ )

findchangepts( ___ )
```

Description

`ipt = findchangepts(x)` returns the index at which the mean of `x` changes most significantly.

`ipt = findchangepts(x,Name,Value)` specifies additional options using name-value pair arguments. Options include the statistic to measure, the number of changepoints to report, and the minimum distance between changepoints.

`[ipt,residual] = findchangepts(___)` also returns the residual error of the signal against the modeled changes, incorporating any of the previous specifications.

`findchangepts(___)` without output arguments plots the signal and any detected changepoints.

Examples

Changepoint Search Options

Reset the random number generator for reproducible results. Generate a random signal where:

- The mean is constant in each of seven regions and changes abruptly from region to region.

- The variance is constant in each of five regions and changes abruptly from region to region.

```
rng('default')

lr = 20;

mns = [0 1 4 -5 2 0 1];
nm = length(mns);

vrs = [1 4 6 1 3];
nv = length(vrs);

v = randn(1,lr*nm*nv)/2;

f = reshape(repmat(mns,lr*nv,1),1,lr*nm*nv);
y = reshape(repmat(vrs,lr*nm,1),1,lr*nm*nv);

t = v.*y+f;
```

Plot the signal, highlighting the steps of its construction.

```
subplot(2,2,1)
plot(v)
title('Original')
xlim([0 700])

subplot(2,2,2)
plot([f;v+f]')
title('Means')
xlim([0 700])

subplot(2,2,3)
plot([y;v.*y]')
title('Variances')
xlim([0 700])

subplot(2,2,4)
plot(t)
title('Final')
xlim([0 700])
```

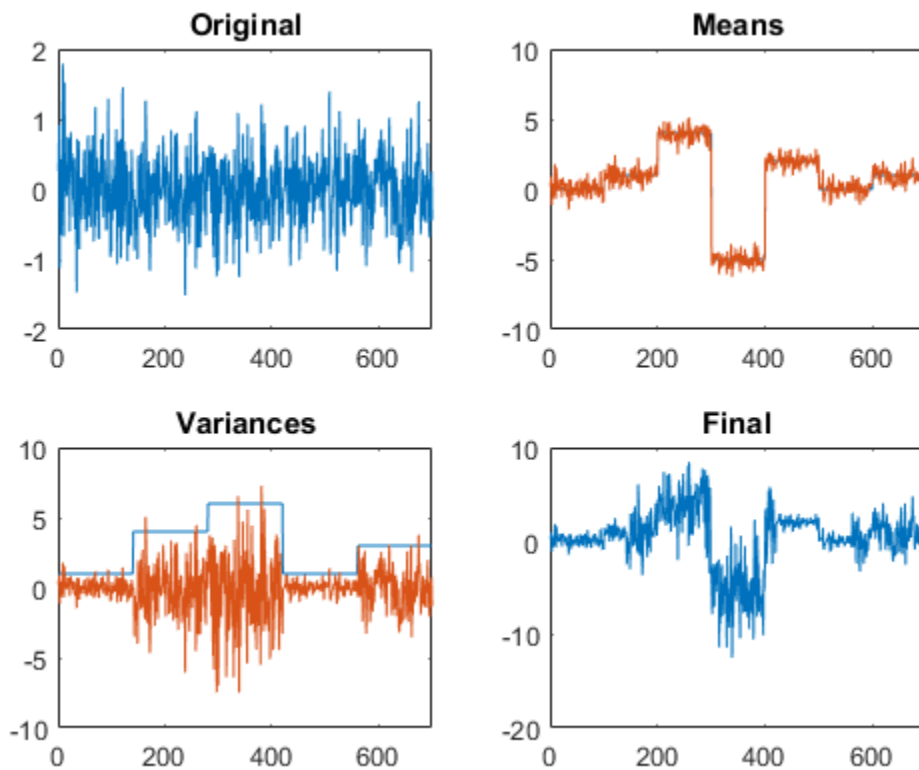

Find the five points where the mean of the signal changes most significantly.

```
figure
findchangepts(t, 'MaxNumChanges',5)
```

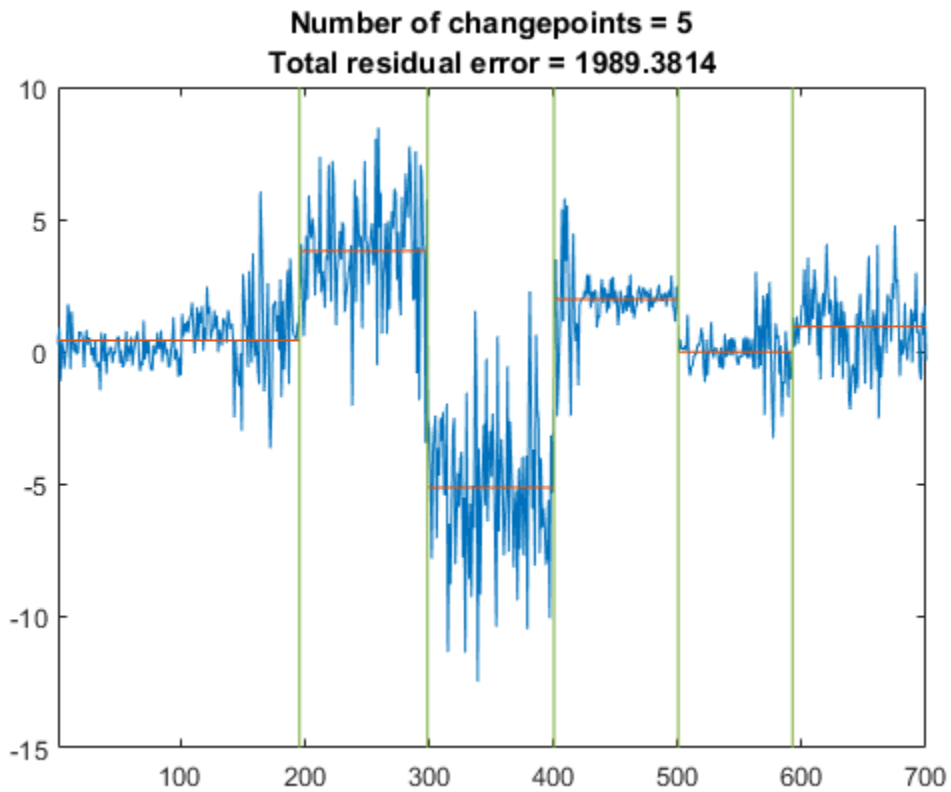

Find the five points where the root-mean-square level of the signal changes most significantly.

```
findchangepts(t, 'MaxNumChanges', 5, 'Statistic', 'rms')
```

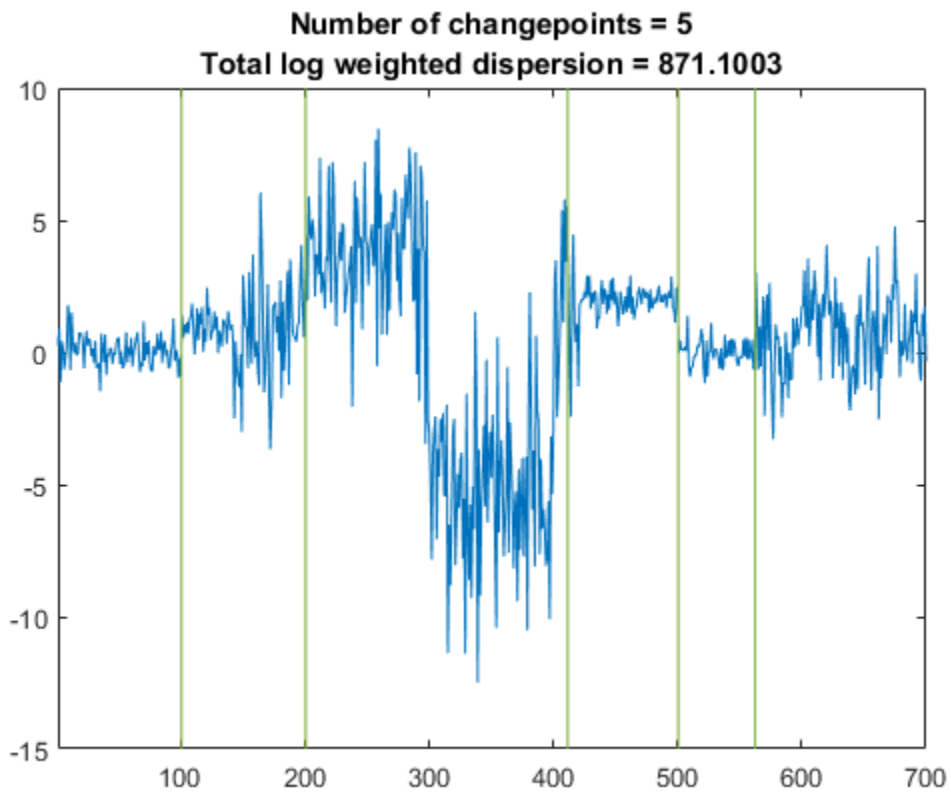

Find the point where the mean and standard deviation of the signal change the most.

```
findchangepts(t, 'Statistic', 'std')
```

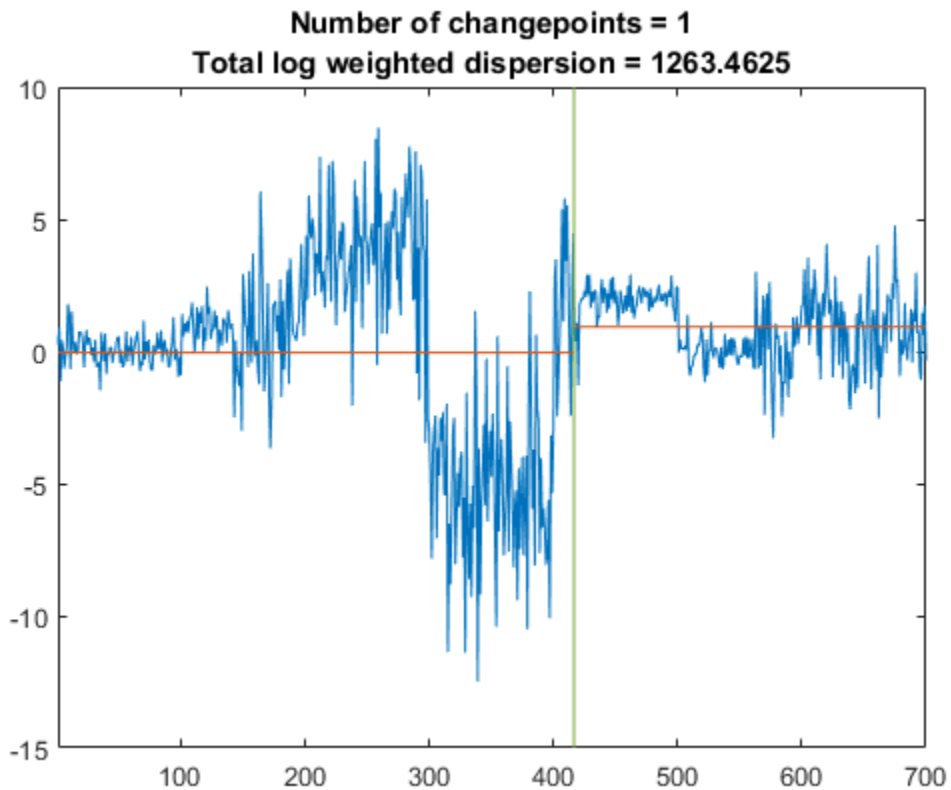

Audio File Segmentation

Load a speech signal sampled at $F_s = 7418$ Hz. The file contains a recording of a female voice saying the word "MATLAB®."

```
load mtlb
```

Discern the vowels and consonants in the word by finding the points at which the variance of the signal changes significantly. Limit the number of changepoints to five.

```
numc = 5;
```

```
[q,r] = findchangepts(mtlb, 'Statistic', 'rms', 'MaxNumChanges', numc)
```

q =

```
132
778
1646
2500
3454
```

r =

```
-4.4055e+03
```

Plot the signal and display the changepoints.

```
findchangepts(mtlb, 'Statistic', 'rms', 'MaxNumChanges', numc)
```

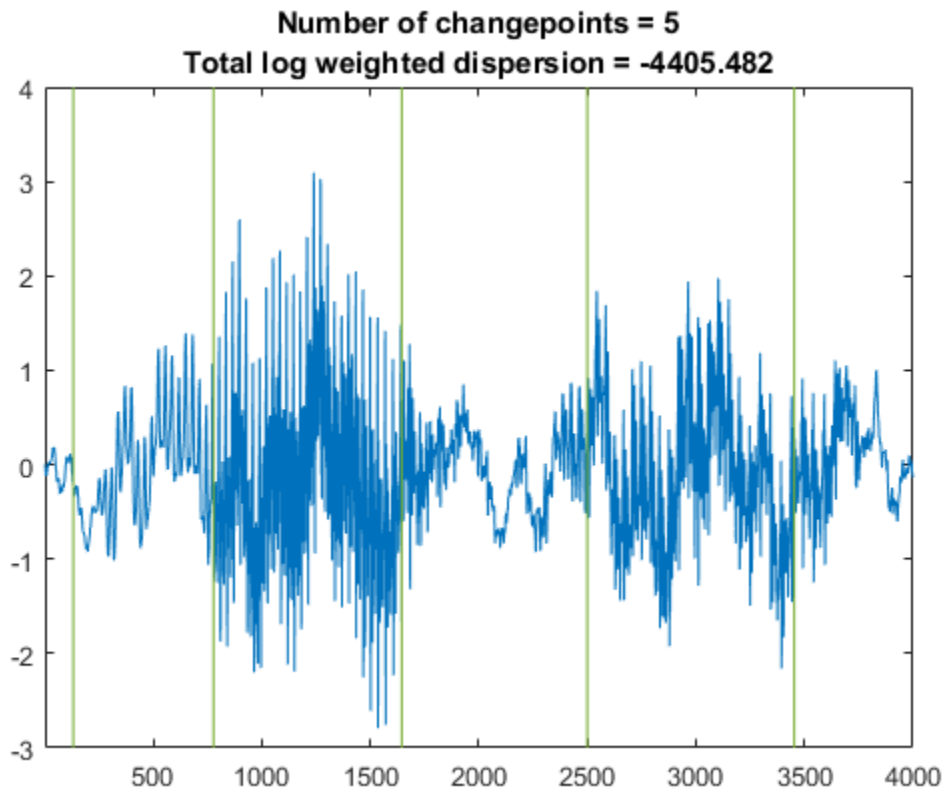
Play the sound with a pause after each of the segments.

```
soundsc(1:q(1),Fs)
for k = 1:length(q)-1
    soundsc(mtlb(q(k):q(k+1)),Fs)
    pause(1)
end
soundsc(q(end):length(mtlb),Fs)
```

Change of Mean, RMS Level, Standard Deviation, and Slope

Create a signal that consists of two sinusoids with varying amplitude and a linear trend.

```
vc = sin(2*pi*(0:201)/17).*sin(2*pi*(0:201)/19).* ...
```

```
[sqrt(0:0.01:1) (1:-0.01:0).^2]+(0:201)/401;
```

Find the points where the signal mean changes most significantly. The 'Statistic' name-value pair is optional in this case. Specify a minimum residual error improvement of 1.

```
findchangepts(vc, 'Statistic', 'mean', 'MinThreshold', 1)
```

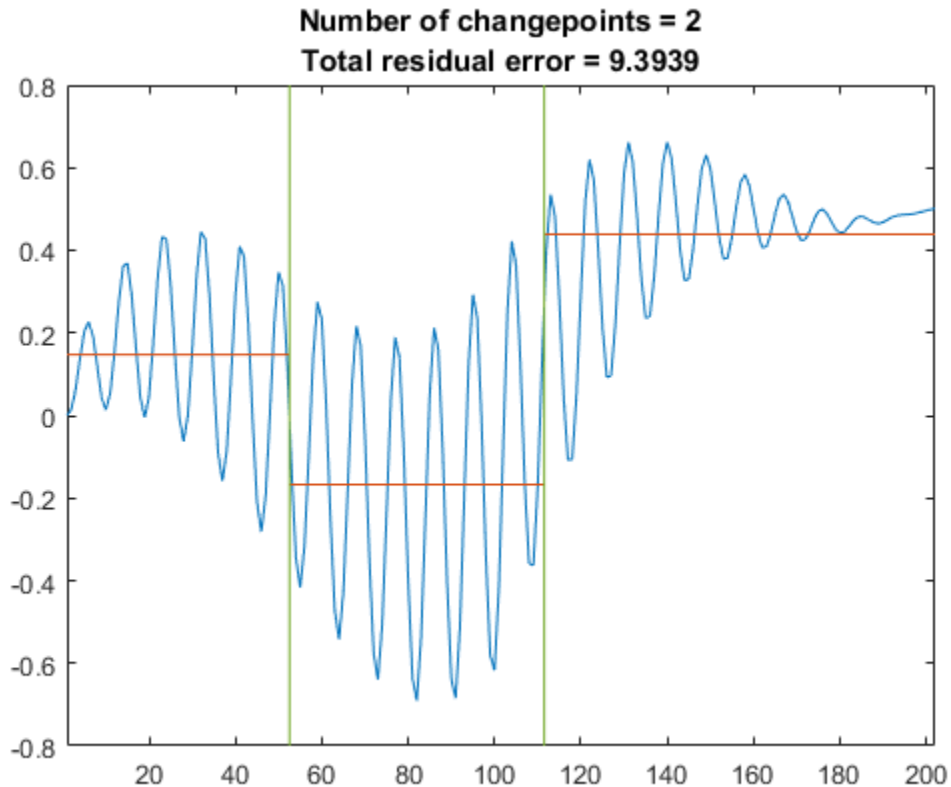

Repeat the computation, but now find the points where the root-mean-square level of the signal changes the most. Specify a minimum residual error improvement of 6.

```
findchangepts(vc, 'Statistic', 'rms', 'MinThreshold', 6)
```

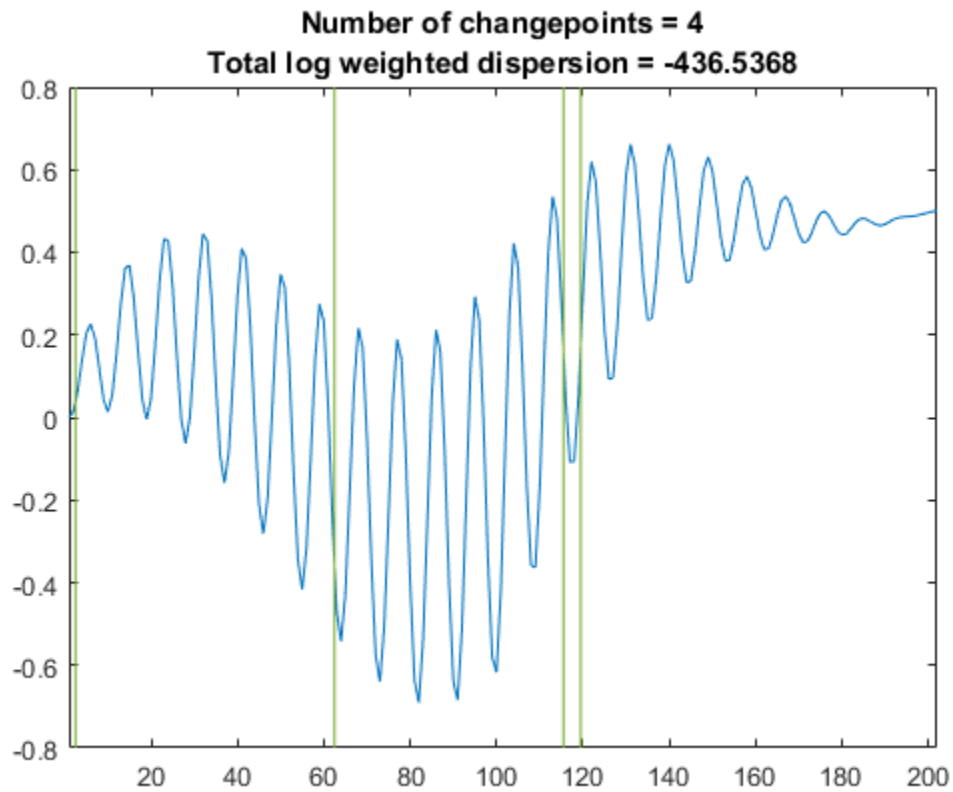

Repeat the computation, but now find the points where the standard deviation of the signal changes most significantly. Specify a minimum residual error improvement of 10.

```
findchangepts(vc, 'Statistic', 'std', 'MinThreshold', 10)
```

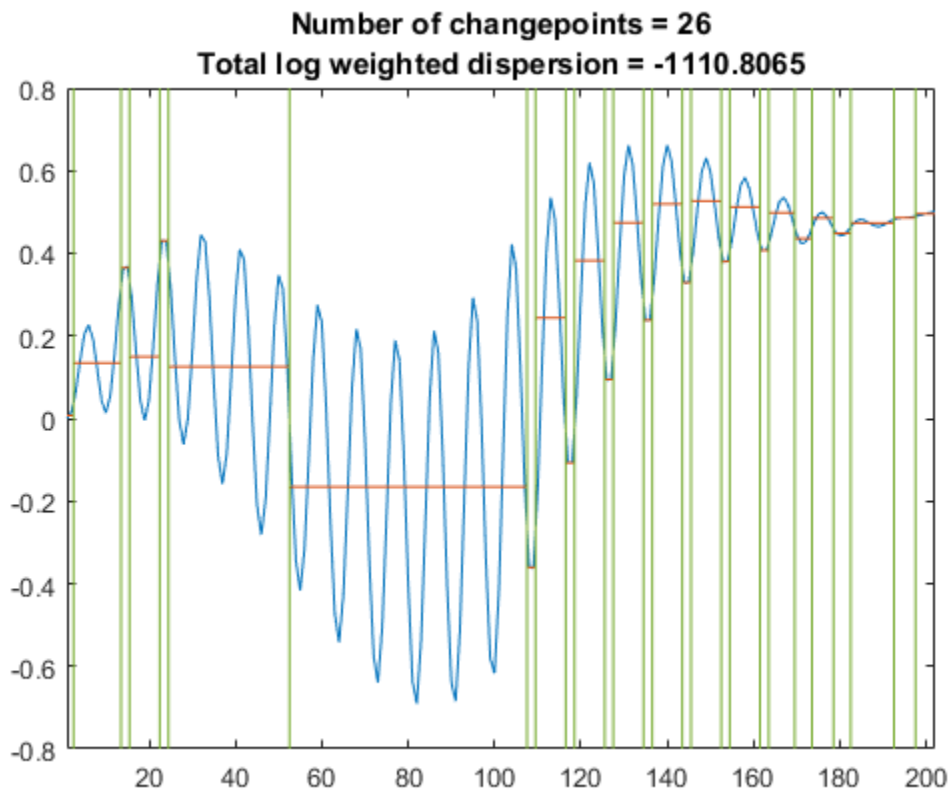

Find the points where the mean and the slope of the signal change most abruptly. Specify a minimum improvement of 0.6.

```
findchangepoints(vc, 'Statistic', 'linear', 'MinThreshold', 0.6)
```

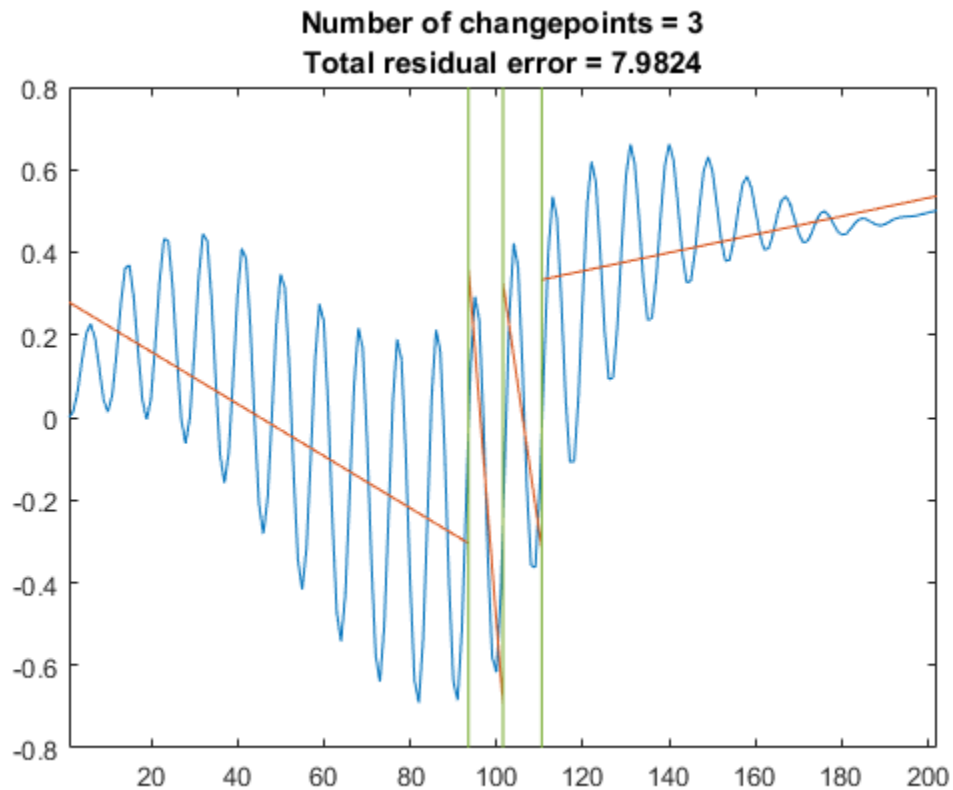

Input Arguments

x — Input signal

real vector

Input signal, specified as a real vector.

Example: `reshape(randn(100,3)+[-3 0 3],1,300)` is a random signal with two abrupt changes in mean.

Example: `reshape(randn(100,3).*[1 20 5],1,300)` is a random signal with two abrupt changes in root-mean-square level.

Data Types: `single` | `double`

Name-Value Pair Arguments

Specify optional comma-separated pairs of `Name`, `Value` arguments. `Name` is the argument name and `Value` is the corresponding value. `Name` must appear inside single quotes (`' '`). You can specify several name and value pair arguments in any order as `Name1, Value1, ..., NameN, ValueN`.

Example: `'MaxNumChanges', 3, 'Statistic', 'rms', 'MinDistance', 20` finds up to three points where the changes in root-mean-square level are most significant and where the points are separated by at least 20 samples.

'MaxNumChanges' — Maximum number of significant changes to return

1 (default) | integer scalar

Maximum number of significant changes to return, specified as the comma-separated pair consisting of `'MaxNumChanges'` and an integer scalar. After finding the point with the most significant change, `findchangepts` gradually loosens its search criterion to include more changepts without exceeding the specified maximum. If any search setting returns more than the maximum, then the function returns nothing. If `'MaxNumChanges'` is not specified, then the function returns the point with the most significant change. You cannot specify `'MinThreshold'` and `'MaxNumChanges'` simultaneously.

Example: `findchangepts([0 1 0])` returns the index of the second sample.

Example: `findchangepts([0 1 0], 'MaxNumChanges', 1)` returns an empty matrix.

Example: `findchangepts([0 1 0], 'MaxNumChanges', 2)` returns the indices of the second and third points.

Data Types: `single` | `double`

'Statistic' — Type of change to detect

'mean' (default) | 'rms' | 'std' | 'linear'

Type of change to detect, specified as the comma-separated pair consisting of `'Statistic'` and one of these values:

- `'mean'` — Detect changes in mean.
- `'rms'` — Detect changes in root-mean-square level.
- `'std'` — Detect changes in standard deviation, using Gaussian log-likelihood.

- **'linear'** — Detect changes in mean and slope.

Example: `findchangepts([0 1 2 1], 'Statistic', 'mean')` returns the index of the second sample.

Example: `findchangepts([0 1 2 1], 'Statistic', 'rms')` returns the index of the third sample.

Data Types: char

'MinDistance' — Minimum number of samples between changepts

integer scalar

Minimum number of samples between changepts, specified as the comma-separated pair consisting of **'MinDistance'** and an integer scalar. If you do not specify this number, then it is set to 1 for changes in mean and to 2 for other changes.

Example:

`findchangepts(sin(2*pi*(0:10)/5), 'MaxNumChanges', 5, 'MinDistance', 1)` returns five indices.

Example:

`findchangepts(sin(2*pi*(0:10)/5), 'MaxNumChanges', 5, 'MinDistance', 3)` returns two indices.

Example:

`findchangepts(sin(2*pi*(0:10)/5), 'MaxNumChanges', 5, 'MinDistance', 5)` returns no indices.

Data Types: single | double

'MinThreshold' — Minimum improvement in total residual error

real scalar

Minimum improvement in total residual error for each changept, specified as the comma-separated pair consisting of **'MinThreshold'** and a real scalar that represents a penalty. This option acts to limit the number of returned significant changes by applying the additional penalty to each prospective changept. You cannot specify **'MinThreshold'** and **'MaxNumChanges'** simultaneously.

Example: `findchangepts([0 1 2], 'MinThreshold', 0)` returns two indices.

Example: `findchangepts([0 1 2], 'MinThreshold', 1)` returns one index.

Example: `findchangepts([0 1 2], 'MinThreshold', 2)` returns no indices.

Data Types: `single` | `double`

Output Arguments

ipt — Changepoint locations

vector

Changepoint locations, returned as a vector of integer indices.

residual — Residual error

vector

Residual error of the signal against the modeled changes, returned as a vector.

References

- [1] Lavielle, Marc. “Using penalized contrasts for the change-point problem.” *Signal Processing*. Vol.85, August 2005, pp.1501–1510.
- [2] Killick, Rebecca, Paul Fearnhead, and Idris A. Eckley. “Optimal detection of changepoints with a linear computational cost.” *Journal of the American Statistical Association*. Vol.107, No.500, 2012, pp.1590–1598.

See Also

See Also

`cusum`

Introduced in R2016a

finddelay

Estimate delay(s) between signals

Syntax

```
D = finddelay(X,Y)
D = finddelay(...,maxlag)
```

Description

`D = finddelay(X,Y)`, where X and Y are row or column vectors, returns an estimate of the delay D between X and Y , where X serves as the reference vector. If Y is delayed with respect to X , then D is positive. If Y is advanced with respect to X , then D is negative. Delays in X and Y can be introduced by prepending zeros.

X and Y need not be exact delayed copies of each other, as `finddelay(X,Y)` returns an estimate of the delay via cross-correlation. However this estimated delay has a useful meaning only if there is sufficient correlation between delayed versions of X and Y . Also, if several delays are possible, as in the case of periodic signals, the delay with the smallest absolute value is returned. In the case that both a positive and a negative delay with the same absolute value are possible, the positive delay is returned.

`D = finddelay(X,Y)`, where X is a matrix of size M_X -by- N_X ($M_X > 1$ and $N_X > 1$) and Y is a matrix of size M_Y -by- N_Y ($M_Y > 1$ and $N_Y > 1$), returns a row vector D of estimated delays between each column of X and the corresponding column of Y . With this usage the number of columns of X must be equal to the number of columns of Y (i.e., $N_X = N_Y$).

`D = finddelay(...,maxlag)`, uses `maxlag` as the maximum correlation window size used to find the estimated delay(s) between X and Y . The usage of `maxlag` is detailed in the table below.

By default, `maxlag` is equal to $\max(L_X, L_Y) - 1$ for two vector inputs (where L_X and L_Y are the lengths of X and Y , respectively), $\max(M_X, M_Y) - 1$ for two matrix inputs, and $\max(L_X, M_Y) - 1$ or $\max(M_X, L_Y) - 1$ for one vector input and one matrix input. If `maxlag` is input as `[]`, it is replaced by the default value. If any element of `maxlag` is negative, it is replaced by its absolute value. If any element of `maxlag` is not integer-valued, or is complex, `Inf`, or `NaN`, then `finddelay` returns an error.

The calculation of the vector of estimated delays, D , depends on X , Y , and `maxlag` as shown in the following table.

maxlag	X	Y	D is calculated by...
Integer-valued scalar	Row or column vector or matrix	Row or column vector or matrix	Cross-correlating the columns of X and Y over a range of lags <code>-maxlag:maxlag</code> .
Integer-valued row or column vector	Row or column vector of length $L_X \geq 1$	Matrix of size M_Y -by- N_Y ($M_Y > 1, N_Y > 1$)	Cross-correlating X and column j of Y over a range of lags <code>-maxlag(j):maxlag(j)</code> , for $j = 1:N_Y$.
Integer-valued row or column vector	Matrix of size M_X -by- N_X ($M_X > 1, N_X > 1$)	Row or column vector of length $L_Y \geq 1$	Cross-correlating column j of X and Y over a range of lags <code>-maxlag(j):maxlag(j)</code> , for $j = 1:N_X$.
Integer-valued row or column vector	Matrix of size M_X -by- N_X ($M_X > 1, N_X > 1$)	Matrix of size M_Y -by- N_Y ($M_Y > 1, N_Y = N_X > 1$)	Cross-correlating column j of X and column j of Y over a range of lags <code>-maxlag(j):maxlag(j)</code> , for $j = 1:N_Y$.

Treating X as Multiple Channels

If you wish to treat a row vector X of length L_X as comprising one sample from L_X different channels, you need to append one or more rows of zeros to X so that it appears as a matrix. Then each column of X will be considered a channel.

For example, $X = [1 \ 1 \ 1 \ 1]$ is considered a single channel comprising four samples. To treat it as four different channels, each channel comprising one sample, define a new matrix X_m :

$$X_m = \begin{bmatrix} 1 & 1 & 1 & 1; \\ 0 & 0 & 0 & 0 \end{bmatrix};$$

Each column of X_m corresponds to a single channel, each one containing the samples 1 and 0.

Examples

X and Y Are Vectors, and maxlag Is Not Specified

The following shows Y being delayed with respect to X by two samples.

```
X = [1 2 3];  
Y = [0 0 1 2 3];  
D = finddelay(X,Y)
```

```
D = 2
```

Here is a case of Y advanced with respect to X by three samples.

```
X = [0 0 0 1 2 3 0 0]';  
Y = [1 2 3 0]';  
D = finddelay(X,Y)
```

```
D = -3
```

The following illustrates a case where Y is aligned with X but is noisy.

```
X = [0 0 1 2 3 0];  
Y = [0.02 0.12 1.08 2.21 2.95 -0.09];  
D = finddelay(X,Y)
```

```
D = 0
```

If Y is a periodic version of X, the smallest possible delay is returned.

```
X = [0 1 2 3];  
Y = [1 2 3 0 0 0 0 1 2 3 0 0];  
D = finddelay(X,Y)
```

```
D = -1
```

X Is a Vector, Y Is a Matrix, and maxlag Is a Scalar

maxlag is specified as a scalar (same maximum window sizes).

```
X = [0 1 2];  
Y = [0 1 0 0;  
      1 2 0 0;  
      2 0 1 0;  
      0 0 2 1];  
maxlag = 3;  
D = finddelay(X,Y,maxlag)
```

```
D =
```

```
0    -1    1    1
```

X and Y Are Matrices, and maxlag Is Not Specified

Specify X and Y of the same size. `finddelay` works column-by-column.

```
X = [0 1 0 0;  
     1 2 0 0;  
     2 0 1 0;  
     1 0 2 1;  
     0 0 0 2];  
Y = [0 0 1 0;  
     1 1 2 0;  
     2 2 0 1;  
     1 0 0 2;  
     0 0 0 0];  
D = finddelay(X,Y)
```

```
D =  
  
     0     1    -2    -1
```

Repeat the computation, but now add an extra row of zeros as the second row of Y.

```
Y = [0 0 1 0;  
     0 0 0 0;  
     1 1 2 0;  
     2 2 0 1;  
     1 0 0 2;  
     0 0 0 0];  
D = finddelay(X,Y)
```

```
D =  
  
     1     2    -1     0
```

X and Y Are Matrices, and maxlag Is Specified

Create two multichannel signals, X and Y, such that each channel of Y has a delayed identical copy of each channel of X.

```
X = [1 3 2 0 0 0 0 0];
```

```

        0 0 0 0 0 1 3 2]';
Y = [0 0 0 1 3 2;
     1 3 2 0 0 0]';

```

Compute the column-by-column delays. Set a maximum correlation window size of 8 for each channel.

```

maxlag = [8 8];
D = finddelay(X,Y,maxlag)

```

```

D =
     3     -5

```

Decrease the correlation window size to 3 for the first channel and 5 for the second.

```

maxlag = [3 5];
D = finddelay(X,Y,maxlag)

```

```

D =
     3     -5

```

Increase the correlation window size to 5 for the first channel and decrease it to 3 for the second.

```

maxlag = [5 3];
D = finddelay(X,Y,maxlag)

```

```

D =
     3     -3

```

Algorithms

The `finddelay` function uses the `xcorr` function of Signal Processing Toolbox to determine the cross-correlation between each pair of signals at all possible lags specified by the user. The normalized cross-correlation between each pair of signals is then

calculated. The estimated delay is given by the negative of the lag for which the normalized cross-correlation has the largest absolute value.

If more than one lag leads to the largest absolute value of the cross-correlation, such as in the case of periodic signals, the delay is chosen as the negative of the smallest (in absolute value) of such lags.

Pairs of signals need not be exact delayed copies of each other. However, the estimated delay has a useful meaning only if there is sufficient correlation between at least one pair of the delayed signals.

Extended Capabilities

C/C++ Code Generation

Generate C and C++ code using MATLAB® Coder™.

See Also

See Also

`alignsignals` | `dtw` | `edr` | `findsignal` | `xcorr`

findpeaks

Find local maxima

Syntax

```
pks = findpeaks(data)
[pks,locs] = findpeaks(data)
[pks,locs,w,p] = findpeaks(data)

[ ___ ] = findpeaks(data,x)
[ ___ ] = findpeaks(data,Fs)

[ ___ ] = findpeaks( ___ ,Name,Value)

findpeaks( ___ )
```

Description

`pks = findpeaks(data)` returns a vector with the local maxima (peaks) of the input signal vector, `data`. A *local peak* is a data sample that is either larger than its two neighboring samples or is equal to `Inf`. Non-`Inf` signal endpoints are excluded. If a peak is flat, the function returns only the point with the lowest index.

`[pks,locs] = findpeaks(data)` additionally returns the indices at which the peaks occur.

`[pks,locs,w,p] = findpeaks(data)` additionally returns the widths of the peaks as the vector `w` and the prominences of the peaks as the vector `p`.

`[___] = findpeaks(data,x)` specifies `x` as the location vector and returns any of the output arguments from previous syntaxes. `locs` and `w` are expressed in terms of `x`.

`[___] = findpeaks(data,Fs)` specifies the sample rate, `Fs`, of the data. The first sample of `data` is assumed to have been taken at time zero. `locs` and `w` are converted to time units.

`[___] = findpeaks(___ ,Name,Value)` specifies options using name-value pair arguments in addition to any of the input arguments in previous syntaxes.

`findpeaks(___)` without output arguments plots the signal and overlays the peak values.

Examples

Find Peaks in a Vector

Define a vector with three peaks and plot it.

```
data = [25 8 15 5 6 10 10 3 1 20 7];  
plot(data)
```

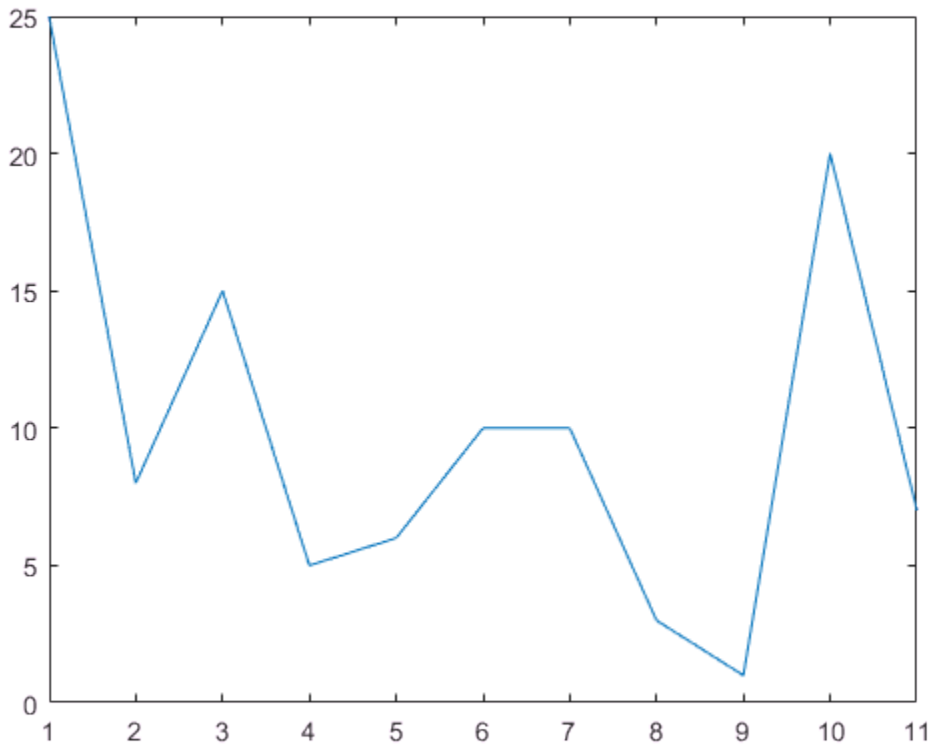

Find the local maxima. The peaks are output in order of occurrence. The first sample is not included despite being the maximum. For the flat peak, the function returns only the point with lowest index.

```
pks = findpeaks(data)
```

```
pks =
```

```
    15    10    20
```

Use `findpeaks` without output arguments to display the peaks.

```
findpeaks(data)
```

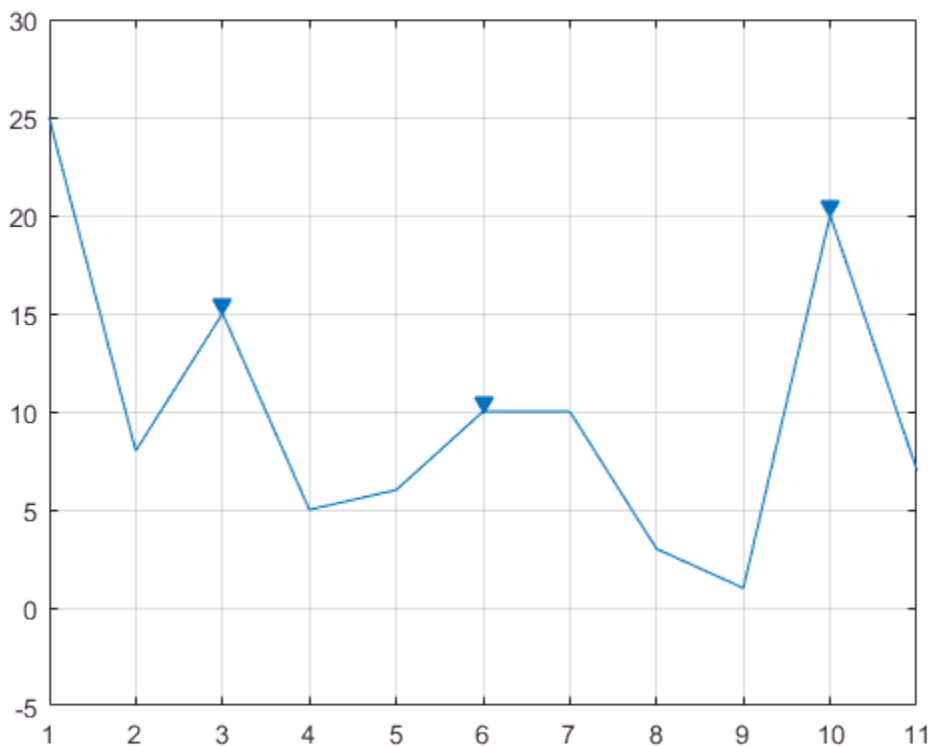

Find Peaks and Their Locations

Create a signal that consists of a sum of bell curves. Specify the location, height, and width of each curve.

```
x = linspace(0,1,1000);  
  
Pos = [1 2 3 5 7 8]/10;  
Hgt = [4 4 4 2 2 3];  
Wdt = [2 6 3 3 4 6]/100;  
  
for n = 1:length(Pos)  
    Gauss(n,:) = Hgt(n)*exp(-((x - Pos(n))/Wdt(n)).^2);  
end  
  
PeakSig = sum(Gauss);  
  
Plot the individual curves and their sum.  
  
plot(x,Gauss,'--',x,PeakSig)
```

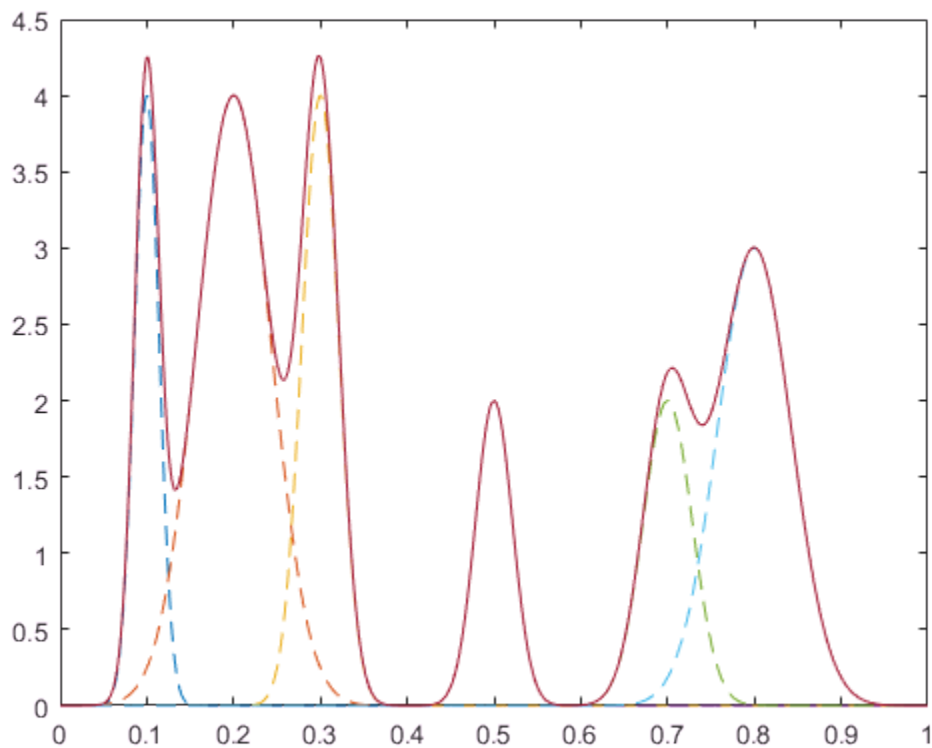

Use `findpeaks` with default settings to find the peaks of the signal and their locations.

```
[pks,locs] = findpeaks(PeakSig,x);
```

Plot the peaks using `findpeaks` and label them.

```
findpeaks(PeakSig,x)
```

```
text(locs+.02,pks,num2str((1:numel(pks))'))
```

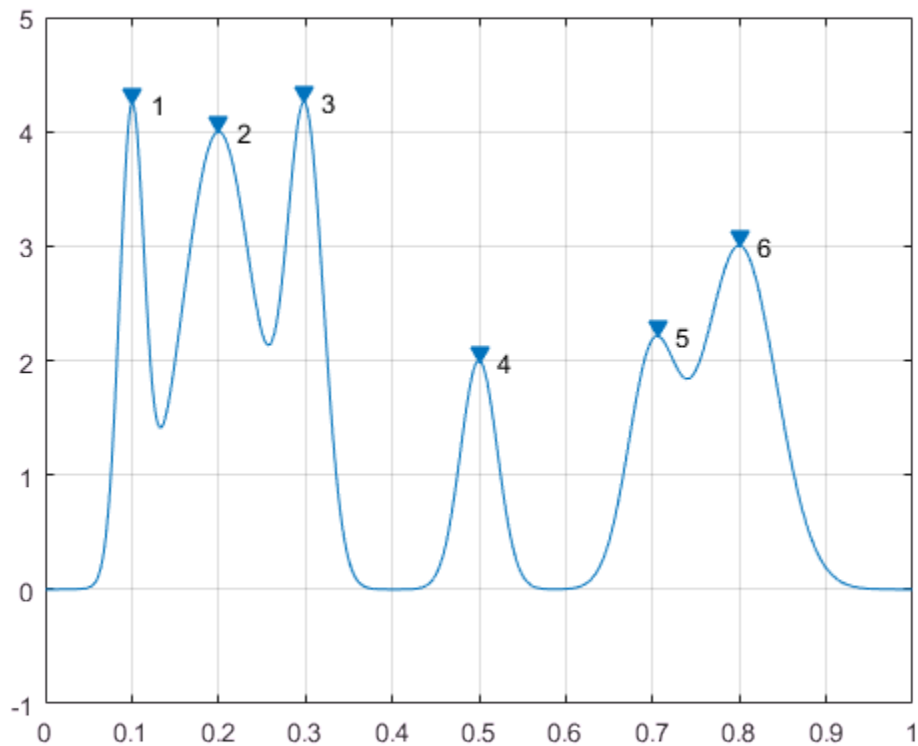

Sort the peaks from tallest to shortest.

```
[psor,lsor] = findpeaks(PeakSig,x,'SortStr','descend');  
findpeaks(PeakSig,x)  
text(lsor+.02,psor,num2str((1:numel(psor))'))
```

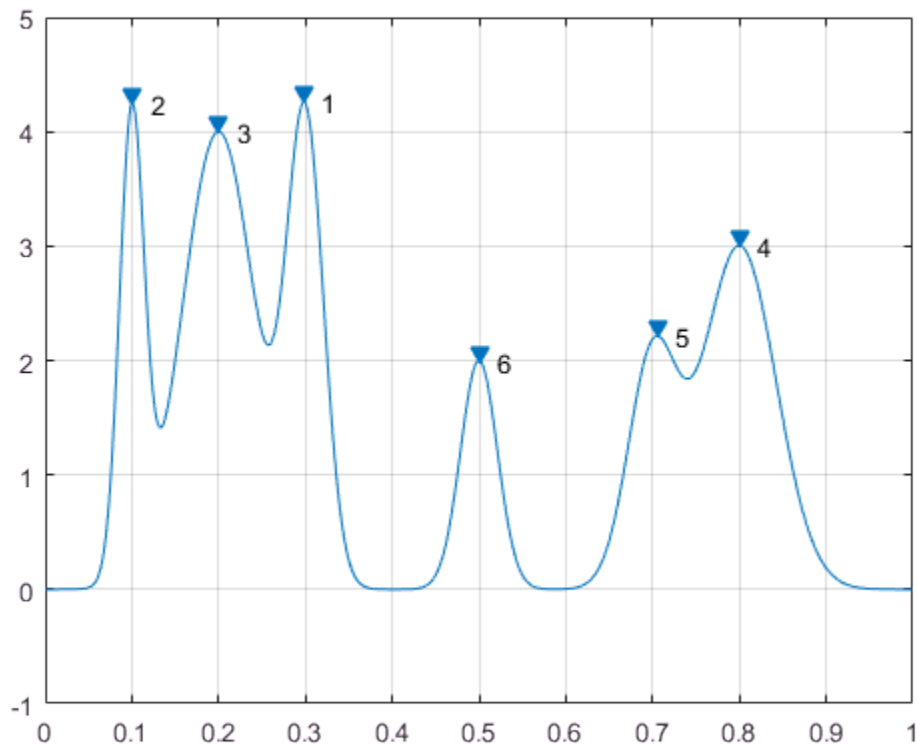

Peak Prominences

Create a signal that consists of a sum of bell curves riding on a full period of a cosine. Specify the location, height, and width of each curve.

```
x = linspace(0,1,1000);  
base = 4*cos(2*pi*x);  
Pos = [1 2 3 5 7 8]/10;  
Hgt = [3 7 5 5 4 5];  
Wdt = [1 3 3 4 2 3]/100;
```

```

for n = 1:length(Pos)
    Gauss(n,:) = Hgt(n)*exp(-((x - Pos(n))/Wdt(n)).^2);
end

PeakSig = sum(Gauss)+base;

Plot the individual curves and their sum.

plot(x,Gauss, '- - ',x,PeakSig,x,base)

```

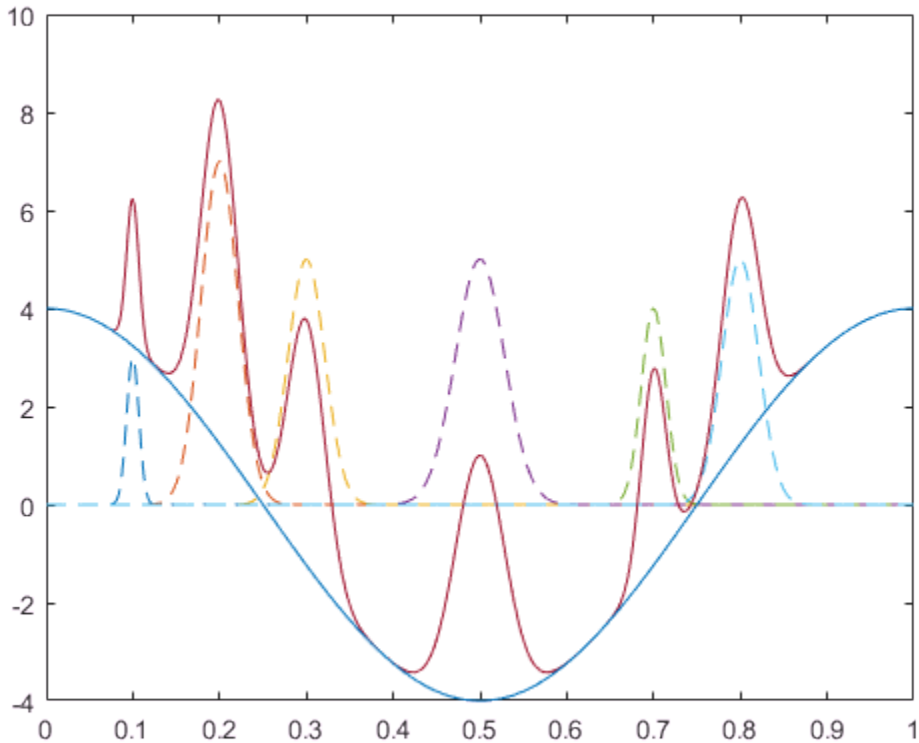

Use `findpeaks` to locate and plot the peaks that have a prominence of at least 4.

```

findpeaks(PeakSig,x, 'MinPeakProminence',4, 'Annotate', 'extents')

```

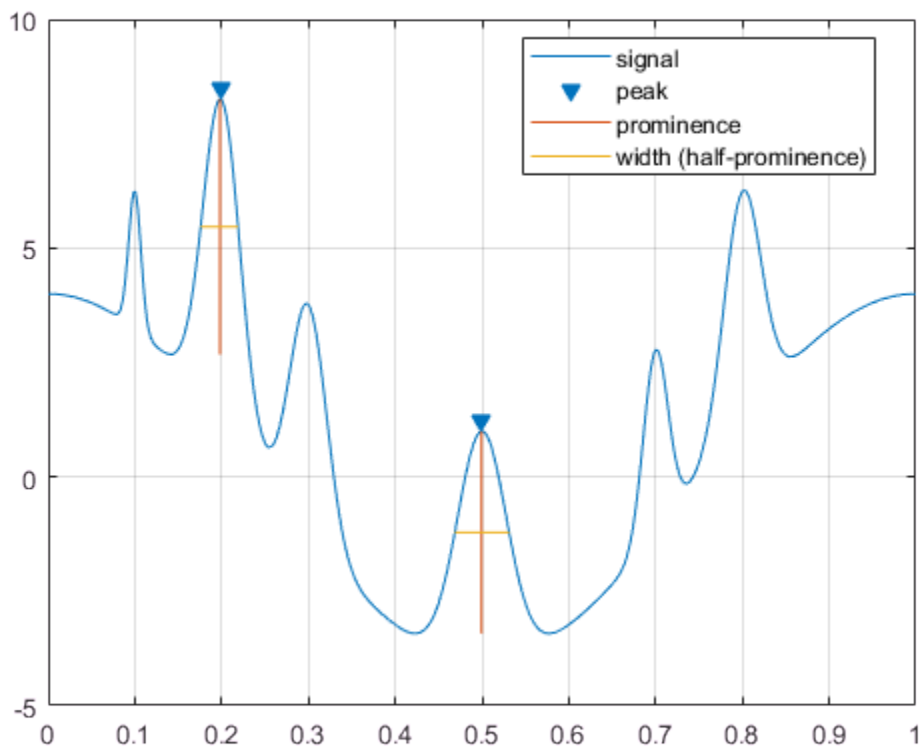

The highest and lowest peaks are the only ones that satisfy the condition.

Display the prominences and the widths at half prominence of all the peaks.

```
[pks,locs,widths,proms] = findpeaks(PeakSig,x);
widths
```

```
widths =
```

```
    0.0154    0.0431    0.0377    0.0625    0.0274    0.0409
```

```
proms
```

```
proms =
```

2.6816 5.5773 3.1448 4.4171 2.9191 3.6363

Find Peaks with Minimum Separation

Sunspots are a cyclic phenomenon. Their number is known to peak roughly every 11 years.

Load the file `sunspot.dat`, which contains the average number of sunspots observed every year from 1700 to 1987. Find and plot the maxima.

```
load sunspot.dat  
  
year = sunspot(:,1);  
avSpots = sunspot(:,2);  
  
findpeaks(avSpots,year)
```

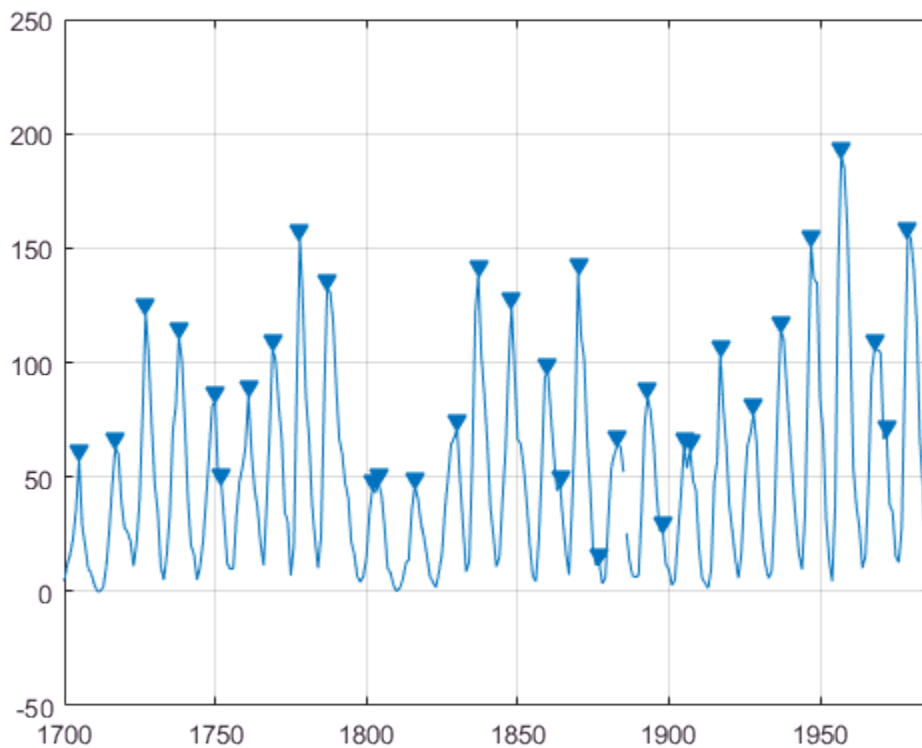
Improve your estimate of the cycle duration by ignoring peaks that are very close to each other. Find and plot the peaks again, but now restrict the acceptable peak-to-peak separations to values greater than six years.

```
findpeaks(avSpots,year, 'MinPeakDistance',6)
```

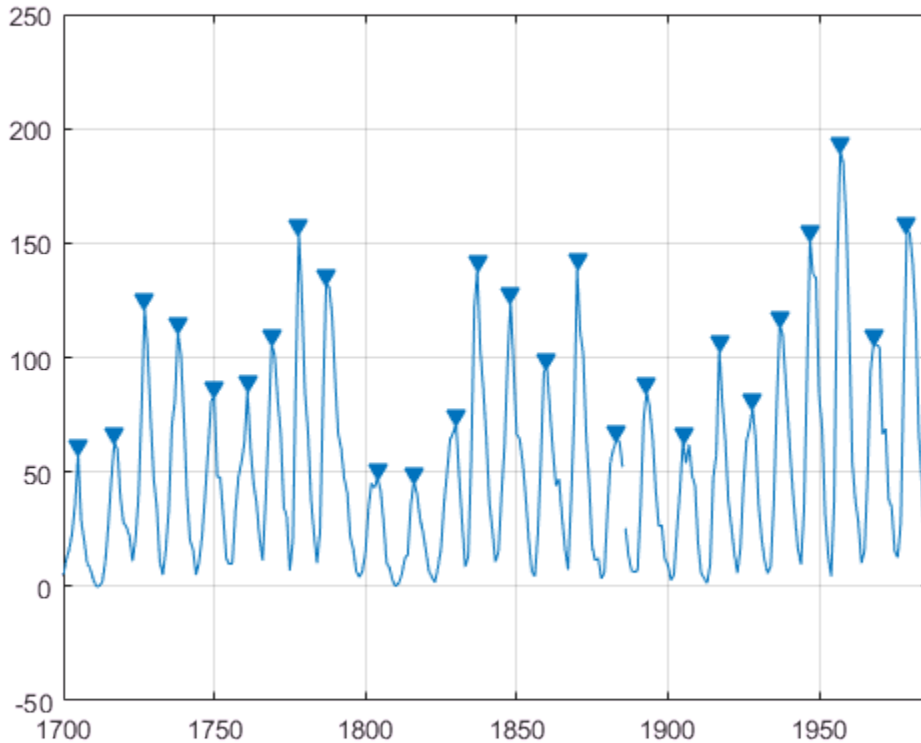

Use the peak locations returned by `findpeaks` to compute the mean interval between maxima.

```
[pks,locs] = findpeaks(avSpots,year,'MinPeakDistance',6);
meanCycle = mean(diff(locs))
meanCycle = 10.9600
```

Create a `datetime` array using the year data. Assume the sunspots were counted every year on March 20th, close to the vernal equinox. Find the peak sunspot years. Use the `years` function to specify the minimum peak separation as a `duration`.

```
ty = datetime(year,3,20);
```

```
[pk,lk] = findpeaks(avSpots,ty,'MinPeakDistance',years(6));
plot(ty,avSpots,lk,pk,'o')
```

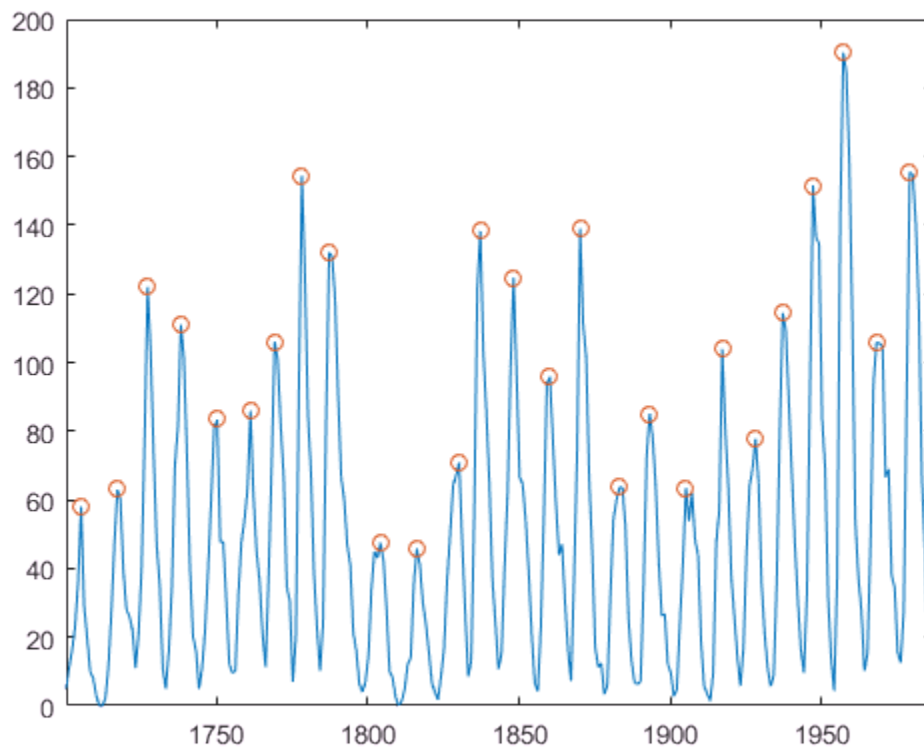

Compute the mean sunspot cycle using `datetime` functionality.

```
dtmCycle = years(mean(diff(lk)))
```

```
dtmCycle = 10.9600
```

Create a timetable with the data. Specify the time variable in years. Plot the data. Show the last five entries of the timetable.

```
TT = timetable(years(year),avSpots);
```

```
plot(TT.Time,TT.Variables)
```

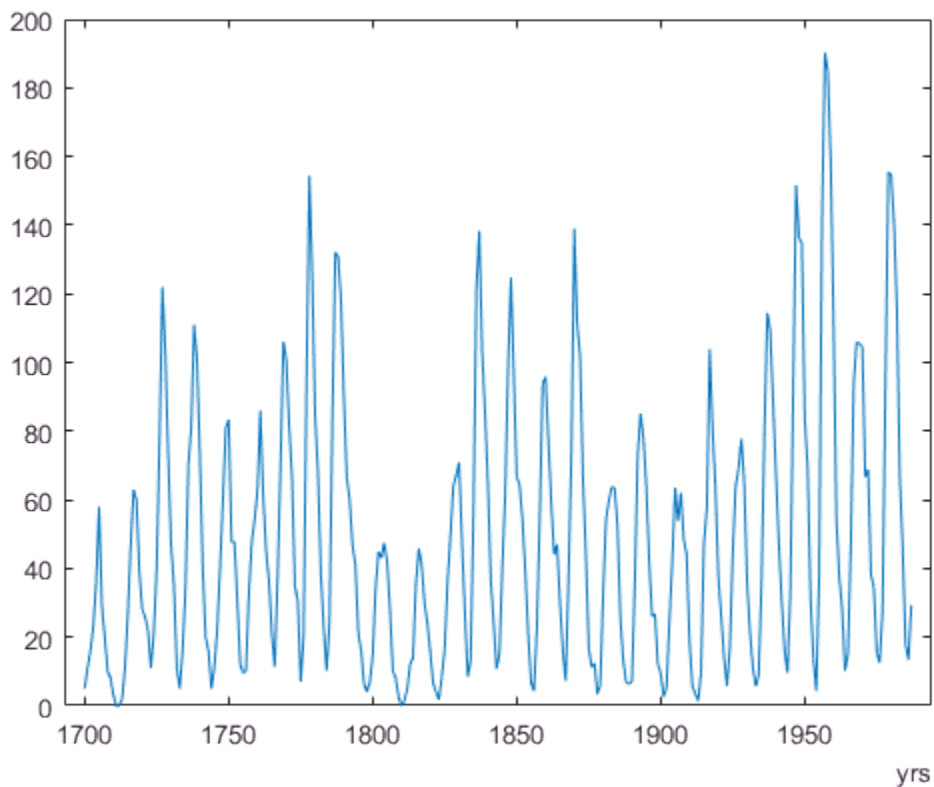

```
entries = TT(end-4:end,:)
```

```
entries = 5x1 timetable
      Time      avSpots
```

	Time	avSpots
1983 yrs		66.6
1984 yrs		45.9
1985 yrs		17.9
1986 yrs		13.4
1987 yrs		29.3

Constrain Peak Features

Load an audio signal sampled at 7418 Hz. Select 200 samples.

```
load mtlb  
select = mtlb(1001:1200);
```

Find the peaks that are separated by at least 5 ms.

To apply this constraint, `findpeaks` chooses the tallest peak in the signal and eliminates all peaks within 5 ms of it. The function then repeats the procedure for the tallest remaining peak and iterates until it runs out of peaks to consider.

```
findpeaks(select,Fs,'MinPeakDistance',0.005)
```

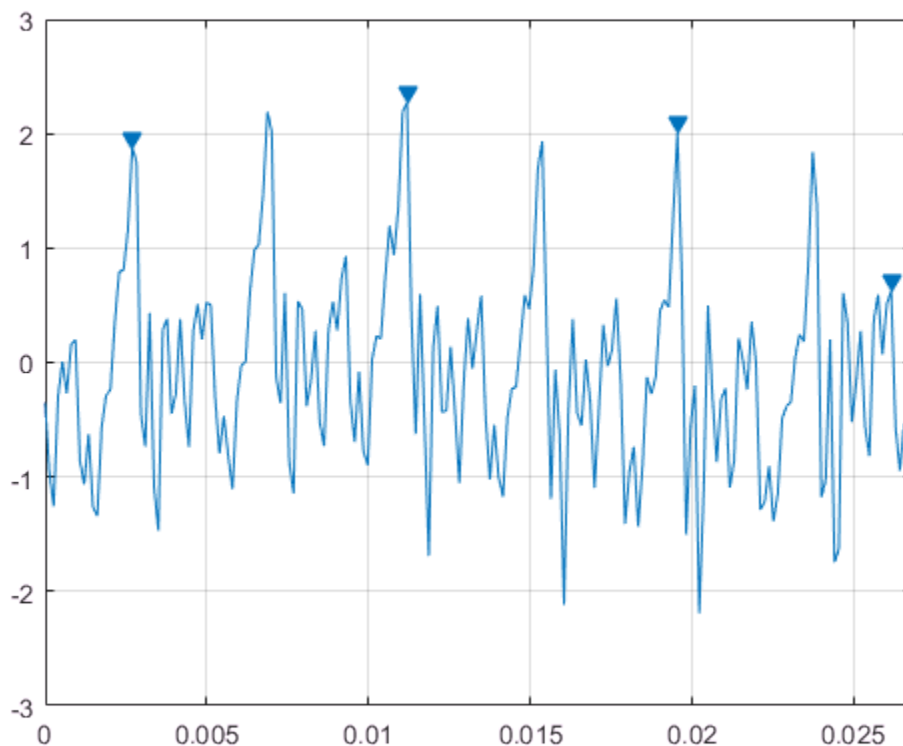

Find the peaks that have an amplitude of at least 1 V.

```
findpeaks(select,Fs, 'MinPeakHeight',1)
```

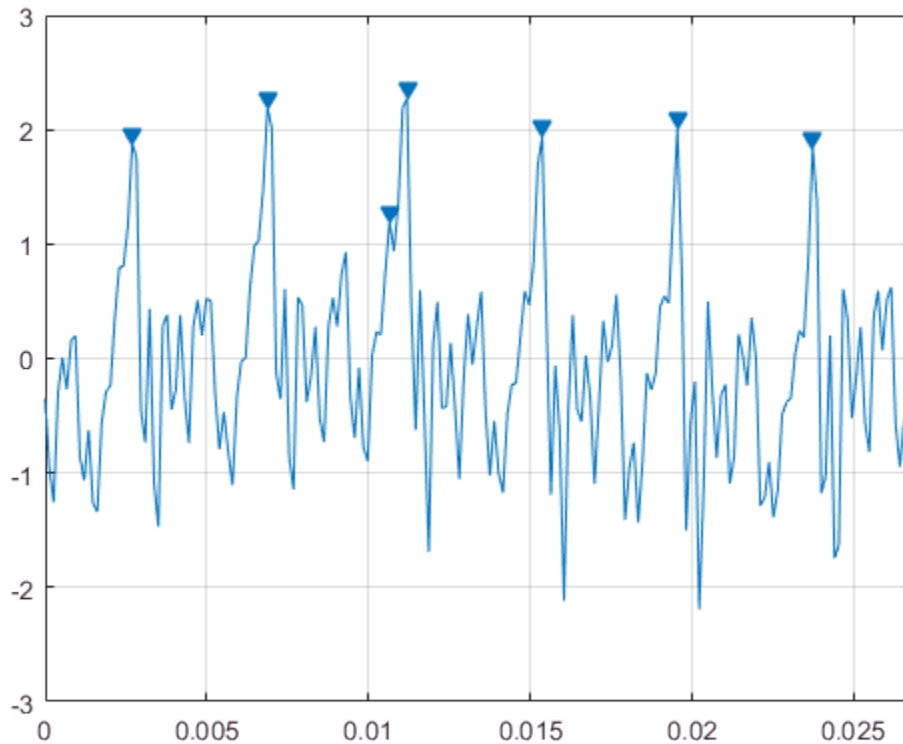

Find the peaks that are at least 1 V higher than their neighboring samples.

```
findpeaks(select,Fs, 'Threshold',1)
```

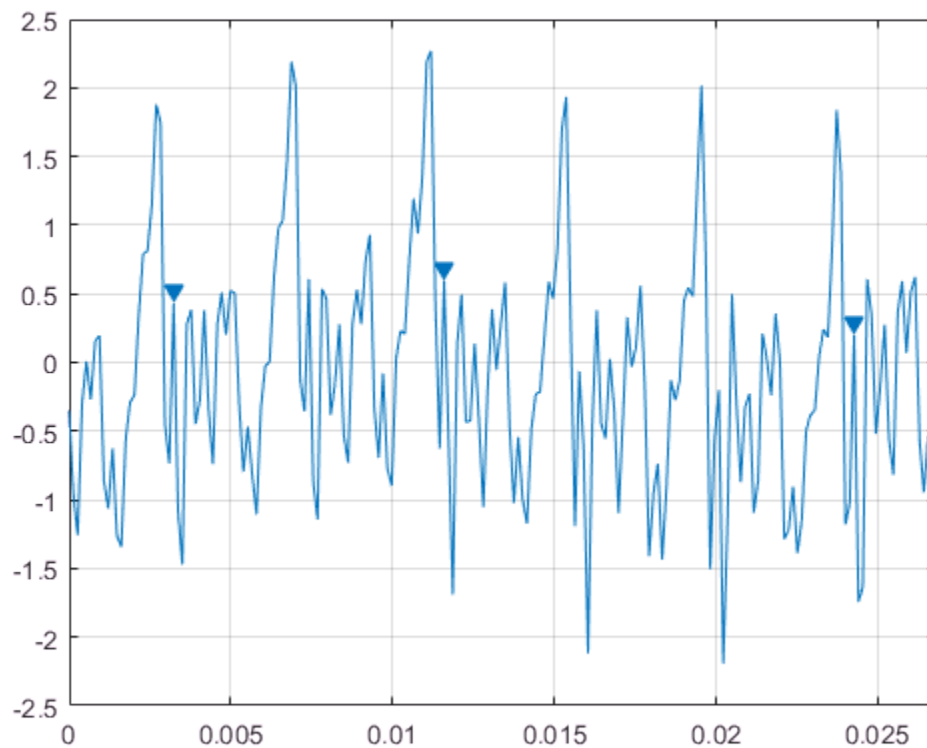

Find the peaks that drop at least 1 V on either side before the signal attains a higher value.

```
findpeaks(select,Fs, 'MinPeakProminence',1)
```

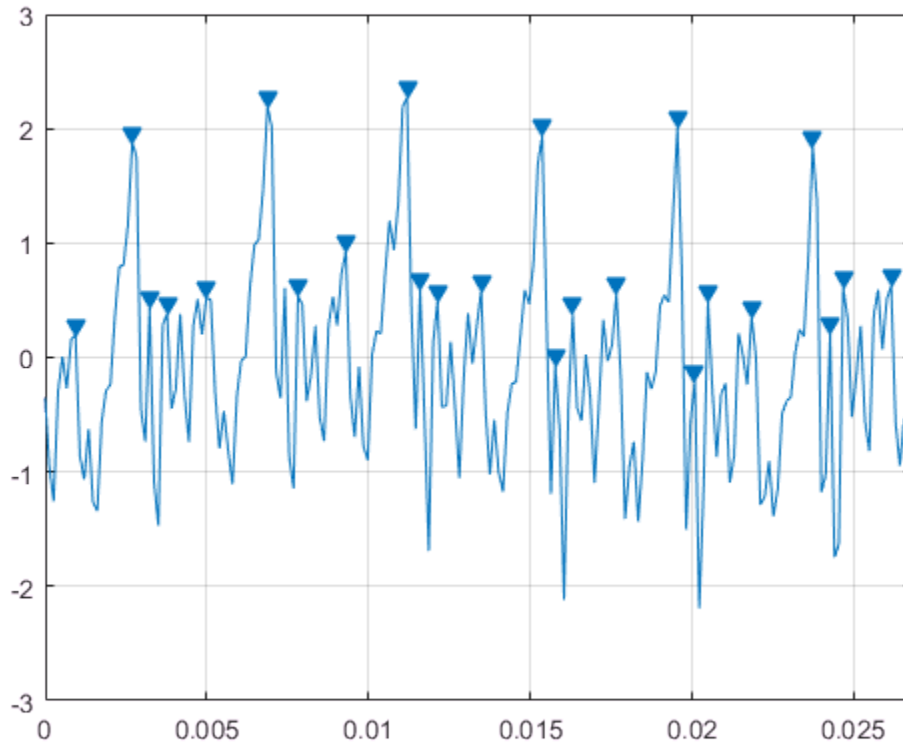

Peaks of Saturated Signal

Sensors can return clipped readings if the data are larger than a given saturation point. You can choose to disregard these peaks as meaningless or incorporate them to your analysis.

Generate a signal that consists of a product of trigonometric functions of frequencies 5 Hz and 3 Hz embedded in white Gaussian noise of variance 0.1^2 . The signal is sampled for one second at a rate of 100 Hz. Reset the random number generator for reproducible results.

```
rng default
```



```
fs = 1e2;  
t = 0:1/fs:1-1/fs;  
  
s = sin(2*pi*5*t).*sin(2*pi*3*t)+randn(size(t))/10;
```

Simulate a saturated measurement by truncating every reading that is greater than a specified bound of 0.32. Plot the saturated signal.

```
bnd = 0.32;  
s(s>bnd) = bnd;  
  
plot(t,s)  
xlabel('Time (s)')
```

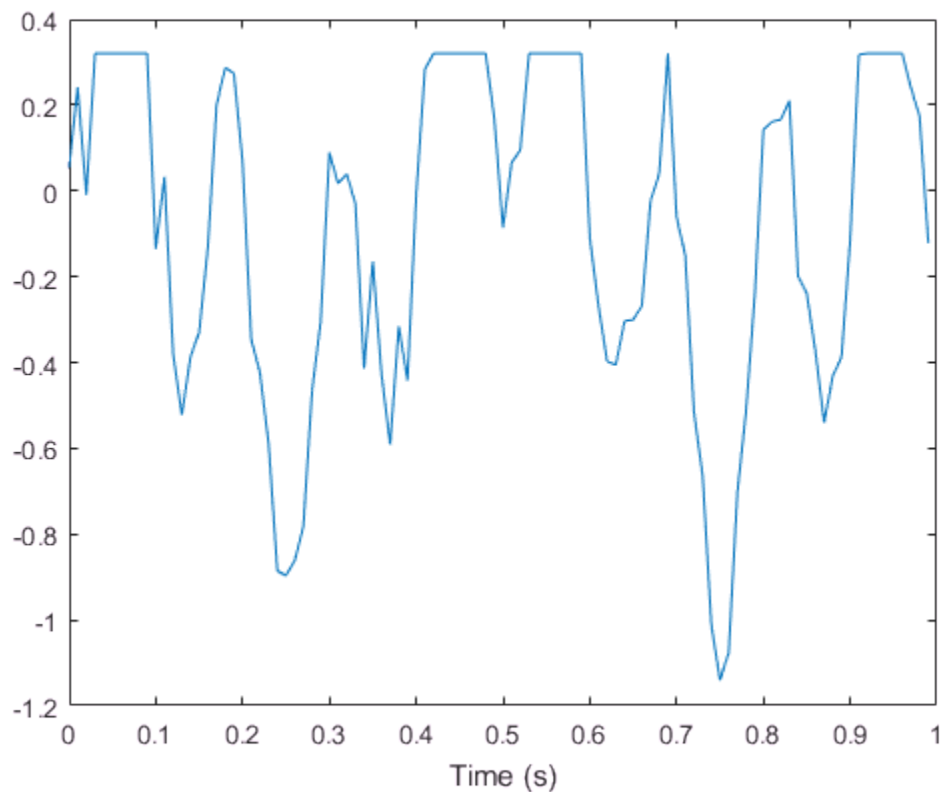

Locate the peaks of the signal. `findpeaks` reports only the rising edge of each flat peak.

```
[pk,lc] = findpeaks(s,t);
```

```
hold on  
plot(lc,pk, 'x')
```

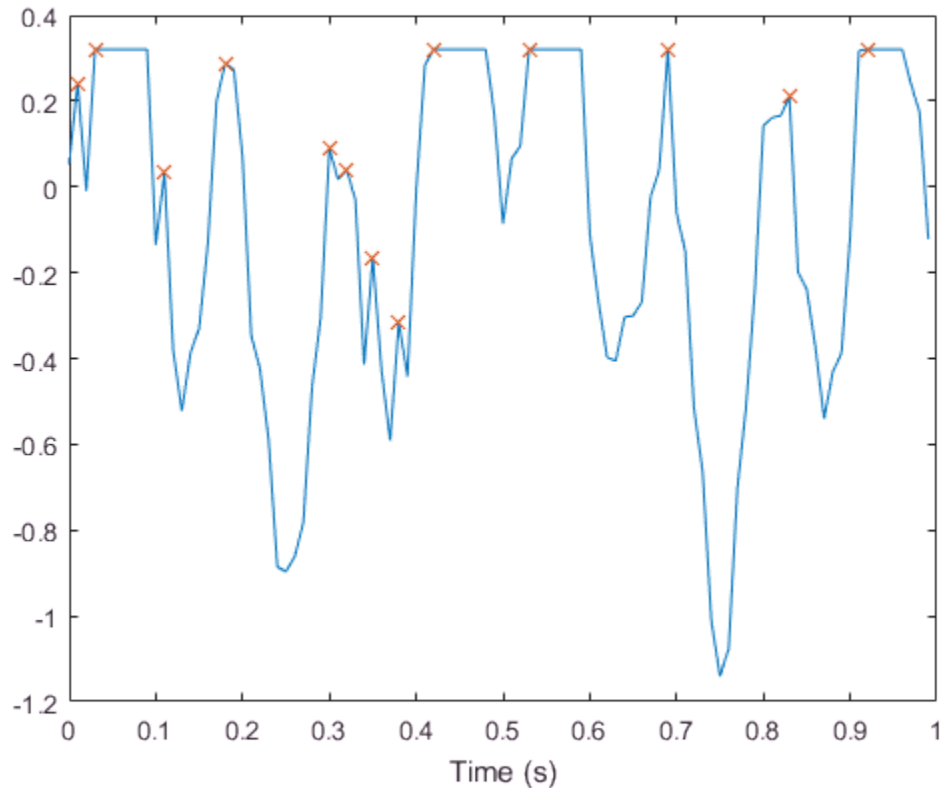

Use the `'Threshold'` name-value pair to exclude the flat peaks. Require a minimum amplitude difference of 10^{-4} between a peak and its neighbors.

```
[pkt,lct] = findpeaks(s,t, 'Threshold', 1e-4);
```

```
plot(lct,pkt, 'o', 'MarkerSize', 12)
```

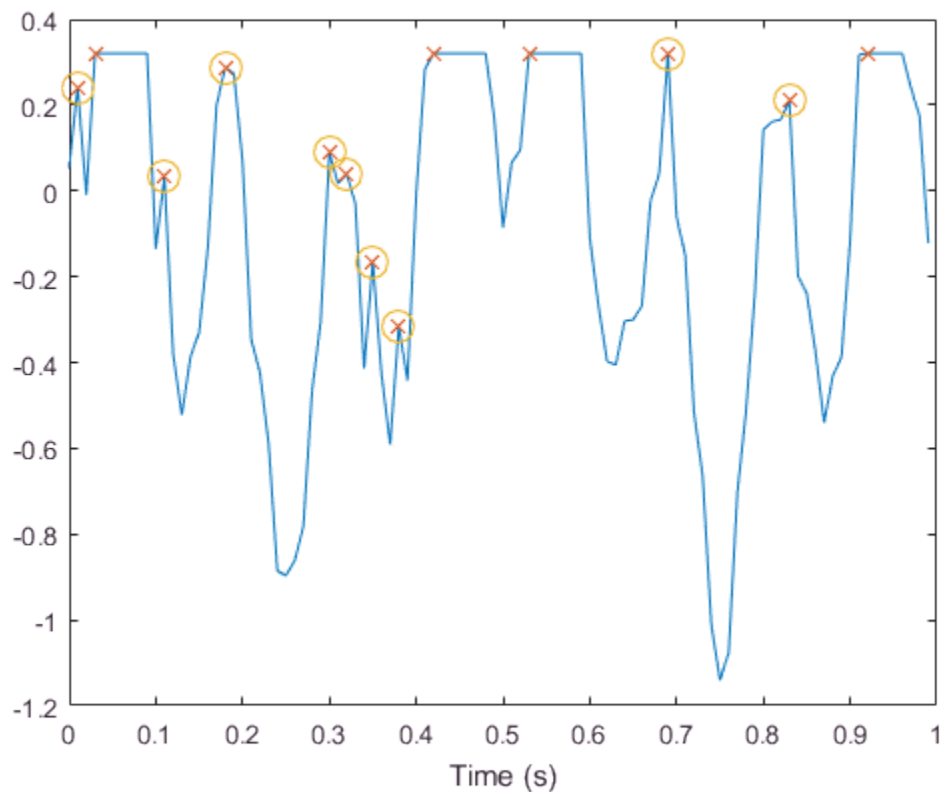

Determine Peak Widths

Create a signal that consists of a sum of bell curves. Specify the location, height, and width of each curve.

```
x = linspace(0,1,1000);  
  
Pos = [1 2 3 5 7 8]/10;  
Hgt = [4 4 2 2 2 3];  
Wdt = [3 8 4 3 4 6]/100;  
  
for n = 1:length(Pos)
```

```
Gauss(n,:) = Hgt(n)*exp(-((x - Pos(n))/Wdt(n)).^2);
end
```

```
PeakSig = sum(Gauss);
```

Plot the individual curves and their sum.

```
plot(x,Gauss,'--',x,PeakSig)
grid
```

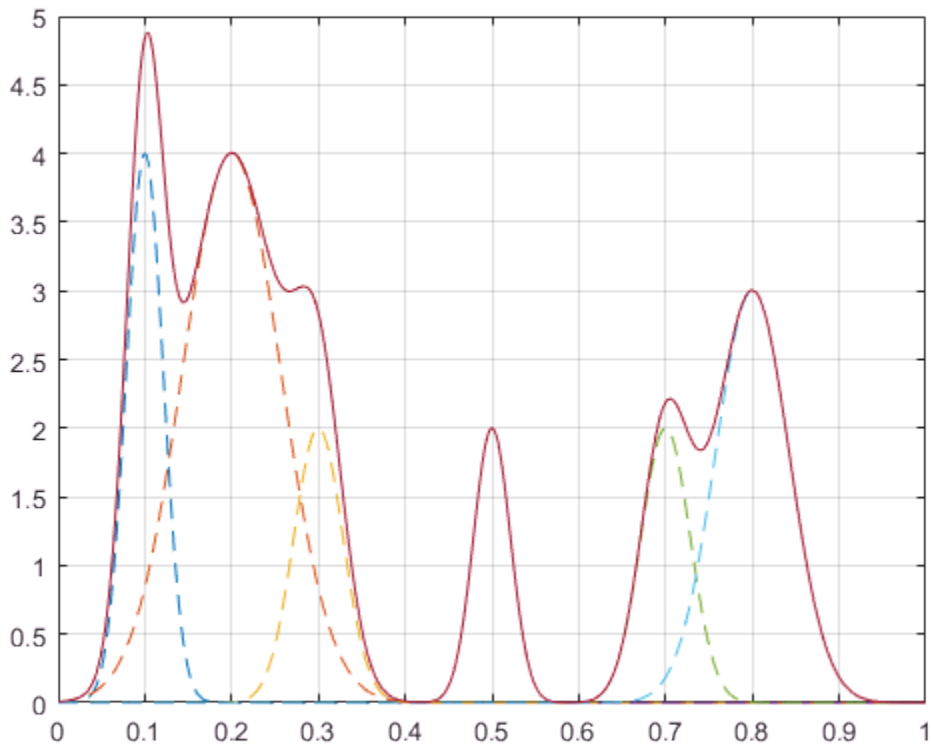

Measure the widths of the peaks using the half prominence as reference.

```
findpeaks(PeakSig,x,'Annotate','extents')
```

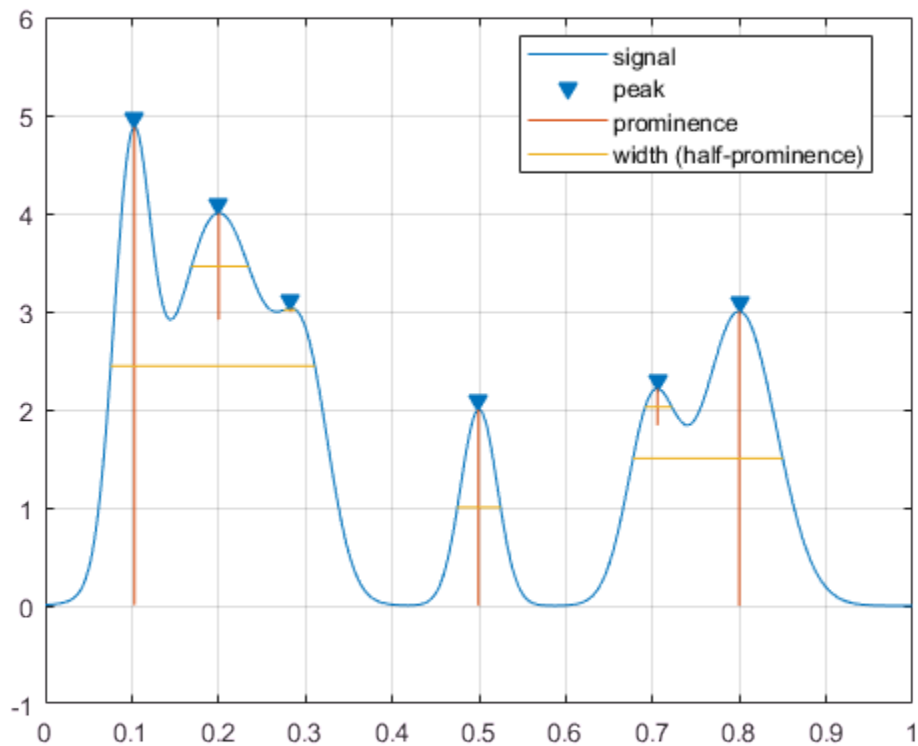

Measure the widths again, this time using the half height as reference.

```
findpeaks(PeakSig,x,'Annotate','extents','WidthReference','halfheight')  
title('Signal Peak Widths')
```

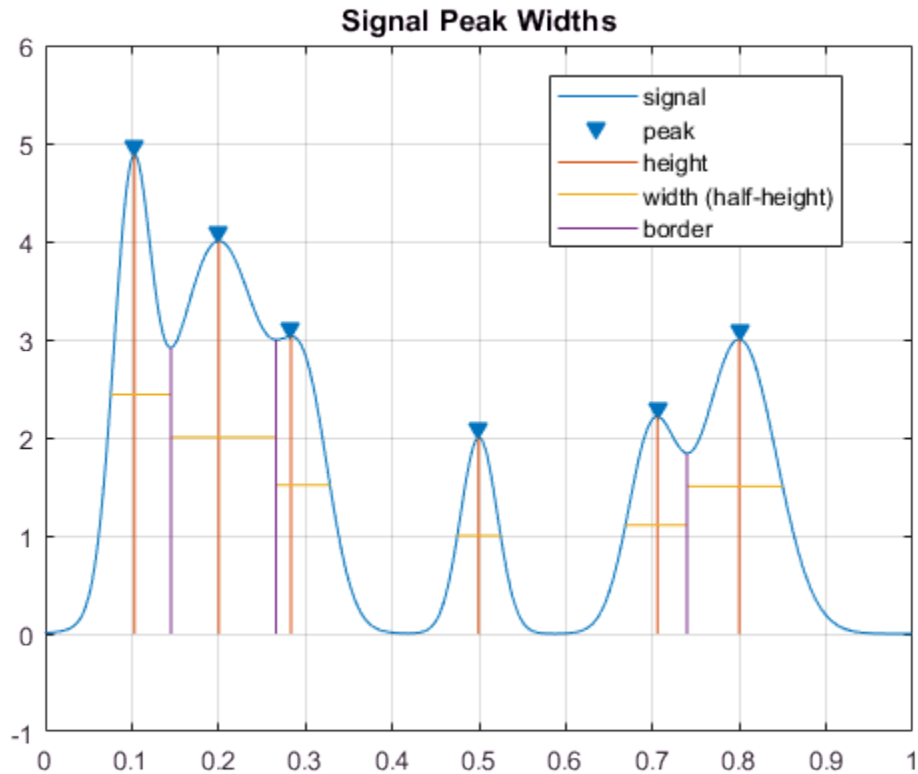

- “Peak Analysis”
- “Find Peaks in Data”

Input Arguments

data — Input data

vector

Input data, specified as a vector. **data** must be real and must have at least three elements.

Data Types: double | single

x — Locations

vector | datetime array

Locations, specified as a vector or a `datetime` array. `x` must increase monotonically and have the same length as `data`. If `x` is omitted, then the indices of `data` are used as locations.

Data Types: double | single | datetime

Fs — Sample rate

positive scalar

Sample rate, specified as a positive scalar. The sample rate is the number of samples per unit time. If the unit of time is seconds, the sample rate has units of hertz.

Data Types: double | single

Name-Value Pair Arguments

Specify optional comma-separated pairs of `Name`, `Value` arguments. `Name` is the argument name and `Value` is the corresponding value. `Name` must appear inside single quotes (' '). You can specify several name and value pair arguments in any order as `Name1`, `Value1`, ..., `NameN`, `ValueN`.

Example: `'SortStr', 'descend', 'NPeaks', 3` finds the three tallest peaks of the signal.

'NPeaks' — Maximum number of peaks

positive integer scalar

Maximum number of peaks to return, specified as the comma-separated pair consisting of `'NPeaks'` and a positive integer scalar. `findpeaks` operates from the first element of the input data and terminates when the number of peaks reaches the value of `'NPeaks'`.

Data Types: double | single

'SortStr' — Peak sorting

'none' (default) | 'ascend' | 'descend'

Peak sorting, specified as the comma-separated pair consisting of `'SortStr'` and one of these values:

- 'none' returns the peaks in the order in which they occur in the input data.
- 'ascend' returns the peaks in ascending or increasing order, from the smallest to the largest value.
- 'descend' returns the peaks in descending order, from the largest to the smallest value.

Data Types: char

'MinPeakHeight' — Minimum peak height

-Inf (default) | real scalar

Minimum peak height, specified as the comma-separated pair consisting of 'MinPeakHeight' and a real scalar. Use this argument to have `findpeaks` return only those peaks higher than 'MinPeakHeight'. Specifying a minimum peak height can reduce processing time.

Data Types: double | single

'MinPeakProminence' — Minimum peak prominence

0 (default) | real scalar

Minimum peak prominence, specified as the comma-separated pair consisting of 'MinPeakProminence' and a real scalar. Use this argument to have `findpeaks` return only those peaks that have a relative importance of at least 'MinPeakProminence'. See “Prominence” on page 1-854 for more information.

Data Types: double | single

'Threshold' — Minimum height difference

0 (default) | nonnegative real scalar

Minimum height difference between a peak and its neighbors, specified as the comma-separated pair consisting of 'Threshold' and a nonnegative real scalar. Use this argument to have `findpeaks` return only those peaks that exceed their immediate neighboring values by at least the value of 'Threshold'.

Data Types: double | single

'MinPeakDistance' — Minimum peak separation

0 (default) | positive real scalar

Minimum peak separation, specified as the comma-separated pair consisting of 'MinPeakDistance' and a positive real scalar. When you specify a value for

'MinPeakDistance', the algorithm chooses the tallest peak in the signal and ignores all peaks within 'MinPeakDistance' of it. The function then repeats the procedure for the tallest remaining peak and iterates until it runs out of peaks to consider.

- If you specify a location vector, `x`, then 'MinPeakDistance' must be expressed in terms of `x`. If `x` is a `datetime` array, then specify 'MinPeakDistance' as a `duration` scalar or as a numeric scalar expressed in days.
- If you specify a sample rate, `Fs`, then 'MinPeakDistance' must be expressed in units of time.
- If you specify neither `x` nor `Fs`, then 'MinPeakDistance' must be expressed in units of samples.

Use this argument to have `findpeaks` ignore small peaks that occur in the neighborhood of a larger peak.

Data Types: `double` | `single` | `duration`

'WidthReference' — Reference height for width measurements

'halfprom' (default) | 'halfheight'

Reference height for width measurements, specified as the comma-separated pair consisting of 'WidthReference' and either 'halfprom' or 'halfheight'. `findpeaks` estimates the width of a peak as the distance between the points where the descending signal intercepts a horizontal reference line. The height of the line is selected using the criterion specified in 'WidthReference':

- 'halfprom' positions the reference line beneath the peak at a vertical distance equal to half the peak prominence. See “Prominence” on page 1-854 for more information.
- 'halfheight' positions the reference line at one-half the peak height. The line is truncated if any of its intercept points lie beyond the borders of the peaks selected by setting 'MinPeakHeight', 'MinPeakProminence', and 'Threshold'. The border between peaks is defined by the horizontal position of the lowest valley between them. Peaks with height less than zero are discarded.

The locations of the intercept points are computed by linear interpolation.

Data Types: `char`

'MinPeakWidth' — Minimum peak width

0 (default) | positive real scalar

Minimum peak width, specified as the comma-separated pair consisting of `'MinPeakWidth'` and a positive real scalar. Use this argument to select only those peaks that have widths of at least `'MinPeakWidth'`.

- If you specify a location vector, `x`, then `'MinPeakWidth'` must be expressed in terms of `x`. If `x` is a `datetime` array, then specify `'MinPeakWidth'` as a `duration` scalar or as a numeric scalar expressed in days.
- If you specify a sample rate, `Fs`, then `'MinPeakWidth'` must be expressed in units of time.
- If you specify neither `x` nor `Fs`, then `'MinPeakWidth'` must be expressed in units of samples.

Data Types: `double` | `single` | `duration`

`'MaxPeakWidth'` — Maximum peak width

`Inf` (default) | positive real scalar

Maximum peak width, specified as the comma-separated pair consisting of `'MaxPeakWidth'` and a positive real scalar. Use this argument to select only those peaks that have widths of at most `'MaxPeakWidth'`.

- If you specify a location vector, `x`, then `'MaxPeakWidth'` must be expressed in terms of `x`. If `x` is a `datetime` array, then specify `'MaxPeakWidth'` as a `duration` scalar or as a numeric scalar expressed in days.
- If you specify a sample rate, `Fs`, then `'MaxPeakWidth'` must be expressed in units of time.
- If you specify neither `x` nor `Fs`, then `'MaxPeakWidth'` must be expressed in units of samples.

Data Types: `double` | `single` | `duration`

`'Annotate'` — Plot style

`'peaks'` (default) | `'extents'`

Plot style, specified as the comma-separated pair consisting of `'Annotate'` and one of these values:

- `'peaks'` plots the signal and annotates the location and value of every peak.
- `'extents'` plots the signal and annotates the location, value, width, and prominence of every peak.

This argument is ignored if you call `findpeaks` with output arguments.

Data Types: `char`

Output Arguments

pks — Local maxima

vector

Local maxima, returned as a vector of signal values. If there are no local maxima, then `pks` is empty.

locs — Peak locations

vector

Peak locations, returned as a vector.

- If you specify a location vector, `x`, then `locs` contains the values of `x` at the peak indices.
- If you specify a sample rate, `Fs`, then `locs` is a vector of time instants.
- If you specify neither `x` nor `Fs`, then `locs` is a vector of integer indices.

w — Peak widths

vector

Peak widths, returned as a vector of real numbers. The width of each peak is computed as the distance between the points to the left and right of the peak where the signal intercepts a reference line whose height is specified by `WidthReference`. The points themselves are found by linear interpolation.

- If you specify a location vector, `x`, then the widths are expressed in terms of `x`.
- If you specify a sample rate, `Fs`, then the widths are expressed in units of time.
- If you specify neither `x` nor `Fs`, then the widths are expressed in units of samples.

p — Peak prominences

vector

Peak prominences, returned as a vector of real numbers. The prominence of a peak is the minimum vertical distance that the signal must descend on either side of the peak

before either climbing back to a level higher than the peak or reaching an endpoint. See “Prominence” on page 1-854 for more information.

Definitions

Prominence

The *prominence* of a peak measures how much the peak stands out due to its intrinsic height and its location relative to other peaks. A low isolated peak can be more prominent than one that is higher but is an otherwise unremarkable member of a tall range.

To measure the prominence of a peak:

- 1** Place a marker on the peak.
- 2** Extend a horizontal line from the peak to the left and right until the line does one of the following:
 - Crosses the signal because there is a higher peak
 - Reaches the left or right end of the signal
- 3** Find the minimum of the signal in each of the two intervals defined in Step 2. This point is either a valley or one of the signal endpoints.
- 4** The higher of the two interval minima specifies the reference level. The height of the peak above this level is its prominence.

`findpeaks` makes no assumption about the behavior of the signal beyond its endpoints, whatever their height. This is reflected in Steps 2 and 4 and often affects the value of the reference level. Consider for example the peaks of this signal:

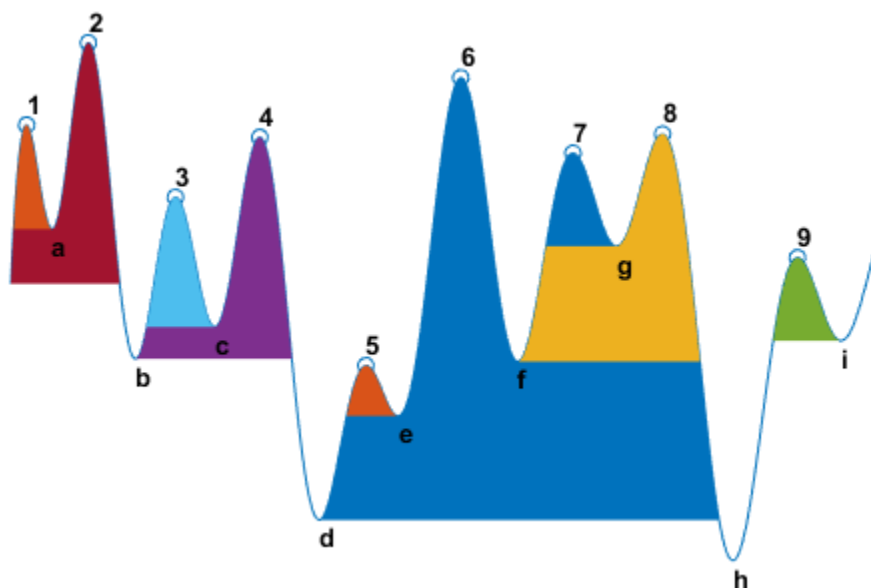

Peak Number	Left Interval Lies Between Peak and	Right Interval Lies Between Peak and	Lowest Point on the Left Interval	Lowest Point on the Right Interval	Reference Level (Highest Minimum)
1	Left end	Crossing due to peak 2	Left endpoint	a	a
2	Left end	Right end	Left endpoint	h	Left endpoint
3	Crossing due to peak 2	Crossing due to peak 4	b	c	c
4	Crossing due to peak 2	Crossing due to peak 6	b	d	b
5	Crossing due to peak 4	Crossing due to peak 6	d	e	e
6	Crossing due to peak 2	Right end	d	h	d
7	Crossing due to peak 6	Crossing due to peak 8	f	g	g

Peak Number	Left Interval Lies Between Peak and	Right Interval Lies Between Peak and	Lowest Point on the Left Interval	Lowest Point on the Right Interval	Reference Level (Highest Minimum)
8	Crossing due to peak 6	Right end	f	h	f
9	Crossing due to peak 8	Crossing due to right endpoint	h	i	i

Extended Capabilities

C/C++ Code Generation

Generate C and C++ code using MATLAB® Coder™.

See Also

See Also

fminbnd | fminsearch | fzero | max

Topics

“Peak Analysis”

“Find Peaks in Data”

Introduced in R2007b

findsignal

Find signal location using similarity search

Syntax

```
[istart,istop,dist] = findsignal(data,signal)
[istart,istop,dist] = findsignal(data,signal,Name,Value)
```

```
findsignal( ___ )
```

Description

`[istart,istop,dist] = findsignal(data,signal)` returns the start and stop indices of a segment of the data array, `data`, that best matches the search array, `signal`. The best-matching segment is such that `dist`, the Euclidean distance between the segment and the search array, is smallest. If `data` and `signal` are matrices, then `findsignal` finds the start and end columns of the region of `data` that best matches `signal`. In that case, `data` and `signal` must have the same number of rows.

`[istart,istop,dist] = findsignal(data,signal,Name,Value)` specifies additional options using name-value pair arguments. Options include the normalization to apply, the number of segments to report, and the distance metric to use.

`findsignal(___)` without output arguments plots `data` and highlights any identified instances of `signal`.

- If the arrays are real vectors, then the function displays `data` as a function of sample number.
- If the arrays are complex vectors, then the function displays `data` on an Argand diagram.
- If the arrays are real matrices, then the function displays `signal` as an image on a subplot and `data` with the highlighted regions on another subplot.
- If the arrays are complex matrices, then their real and imaginary parts appear in the top and bottom half of each image.

Examples

Locate Signal in Data

Generate a data set consisting of a 5 Hz Gaussian pulse with 50% bandwidth, sampled for half a second at a rate of 1 kHz.

```
fs = 1e3;  
  
t = 0:1/fs:0.5;  
data = gauSpuls(t,5,0.5);
```

Create a signal consisting of one-and-a-half cycles of a 10 Hz sinusoid. Plot the data set and the signal.

```
ts = 0:1/fs:0.15;  
signal = cos(2*pi*10*ts);  
  
subplot(2,1,1)  
plot(t,data)  
title('Data')  
subplot(2,1,2)  
plot(ts,signal)  
title('Signal')
```

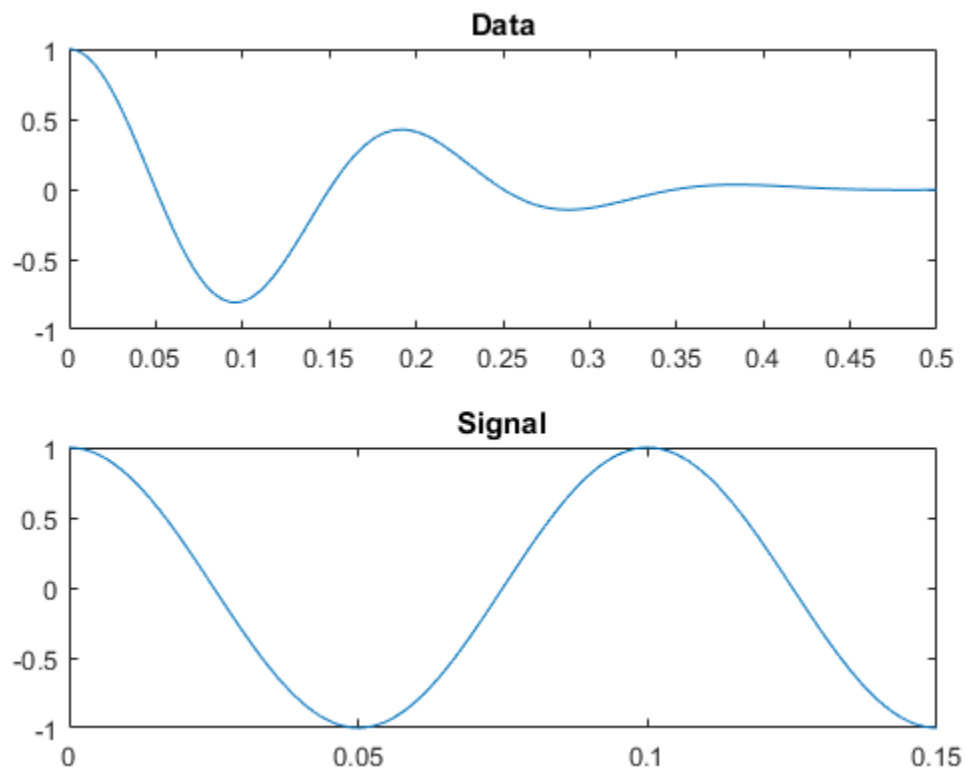
Find the segment of the data that has the smallest Euclidean distance to the signal. Plot the data and highlight the segment.

```
figure  
findsignal(data,signal)
```

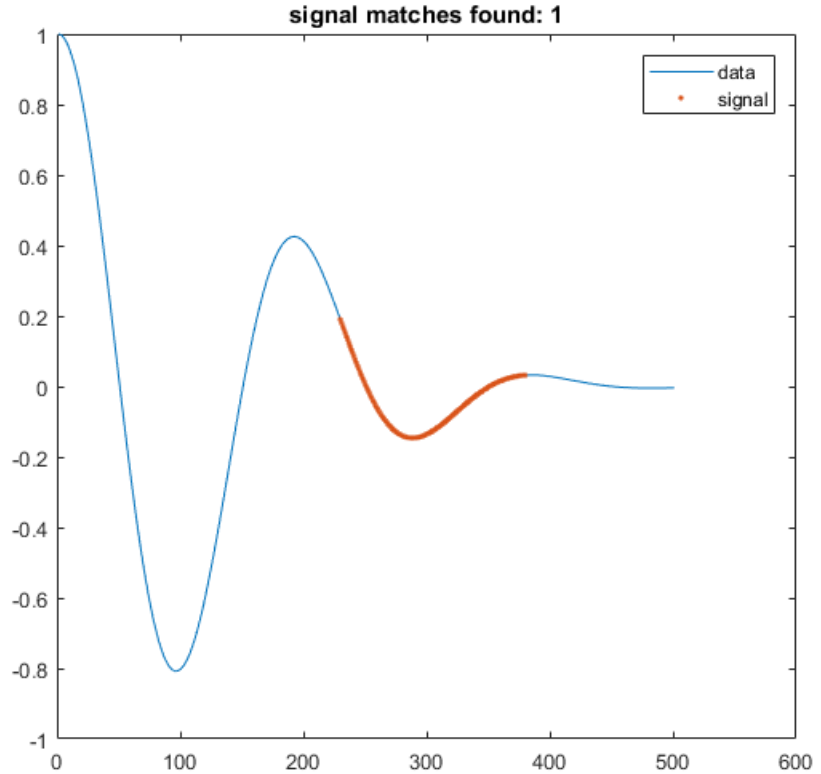
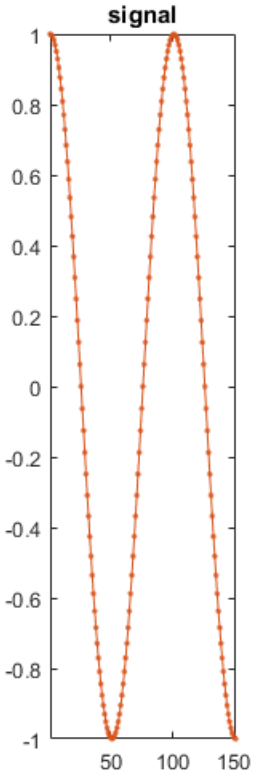

Add two clearly outlying sections to the data set. Find the segment that is closest to the signal in the sense of having the smallest absolute distance.

```
dt = data;
dt(t>0.31&t<0.32) = 2.1;
dt(t>0.32&t<0.33) = -2.1;

findsignal(dt,signal,'Metric','absolute')
```

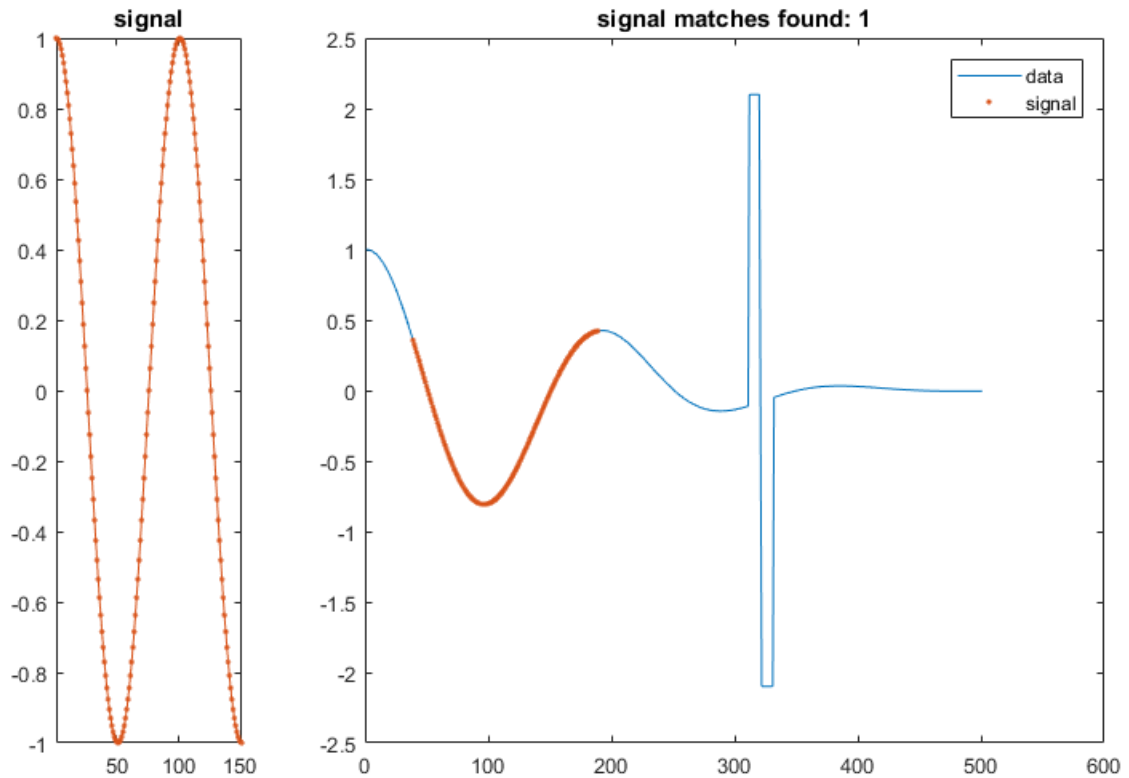

Let the x -axes stretch if the stretching results in a smaller absolute distance between the closest data segment and the signal.

```
findsignal(dt,signal,'TimeAlignment','dtw','Metric','absolute')
```

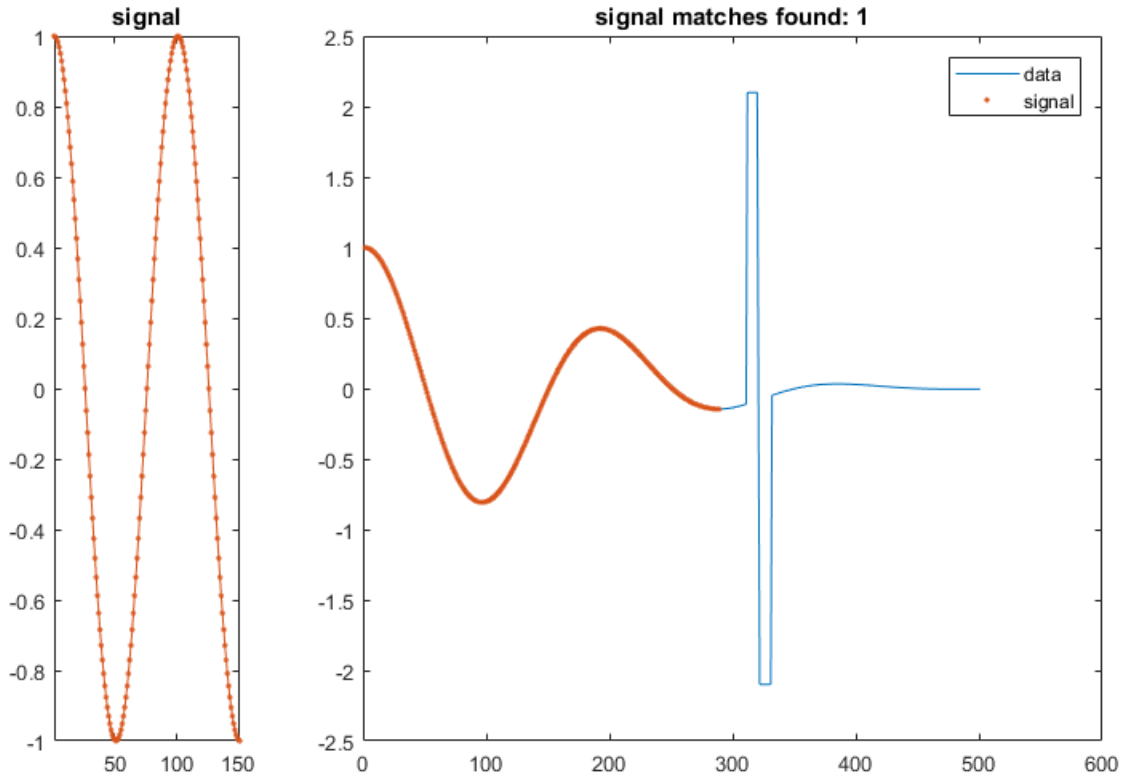

Add two more outlying sections to the data set.

```
dt(t>0.1&t<0.11) = 2.1;
dt(t>0.11&t<0.12) = -2.1;
```

```
findsignal(dt,signal,'TimeAlignment','dtw','Metric','absolute')
```

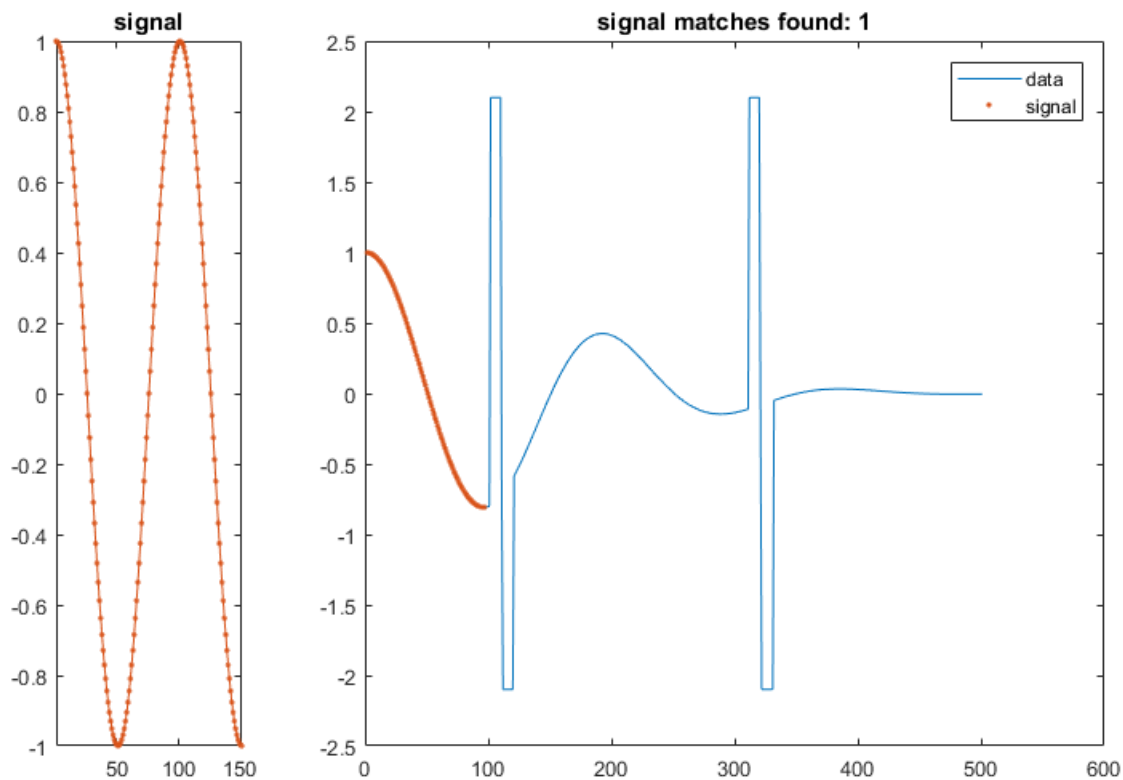

Find the two data segments closest to the signal.

```
findsignal(dt,signal,'TimeAlignment','dtw','Metric','absolute', ...  
           'MaxNumSegments',2)
```

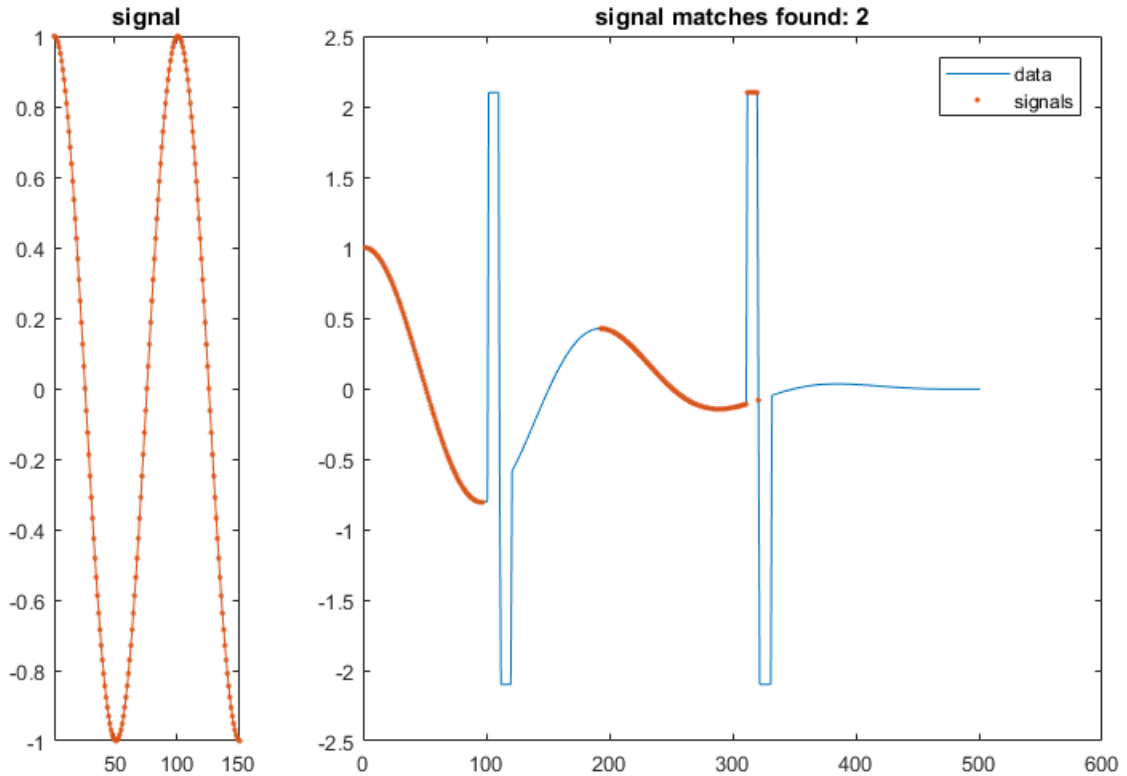

Go back to finding one segment. Choose 'edr' as the x -axis stretching criterion. Select an edit distance tolerance of 3. The edit distance between nonmatching samples is independent of the actual separation, making 'edr' robust to outliers.

```
findsignal(dt,signal,'TimeAlignment','edr','EDRTolerance',3, ...
           'Metric','absolute')
```

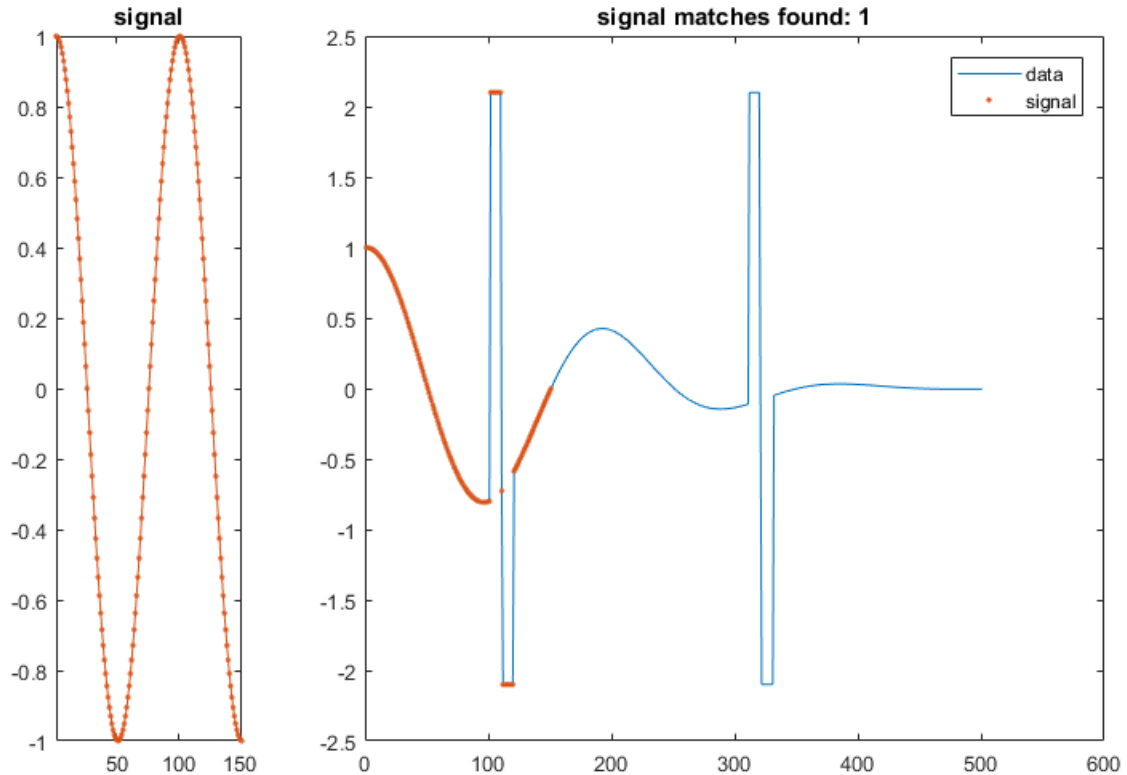

Repeat the calculation, but now normalize the data and the signal.

- Define a moving window with 10 samples to either side of each data and signal point.
- Subtract the mean of the data in the window and divide by the local standard deviation.

Find the normalized data segment that has the smallest absolute distance to the normalized signal. Display the unnormalized and normalized versions of the data and the signal.

```
findsignal(dt,signal,'TimeAlignment','edr','EDRTolerance',3, ...
           'Normalization','zscore','NormalizationLength',21, ...
```

```
'Metric', 'absolute', 'Annotate', 'all')
```

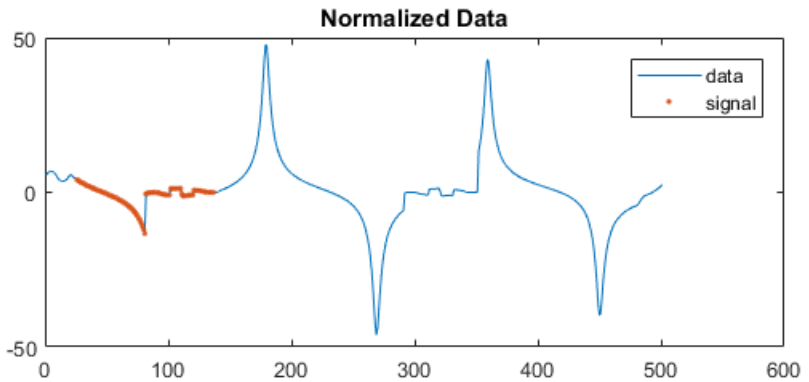
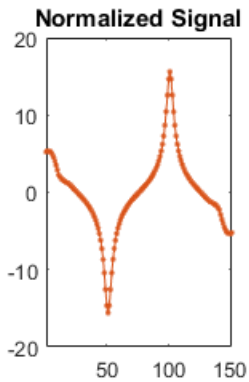
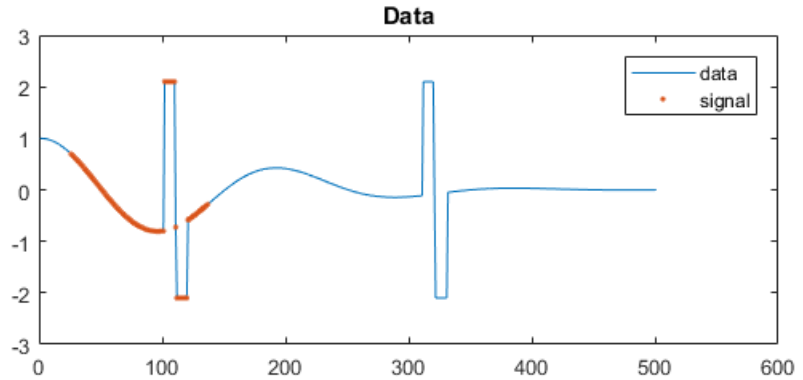
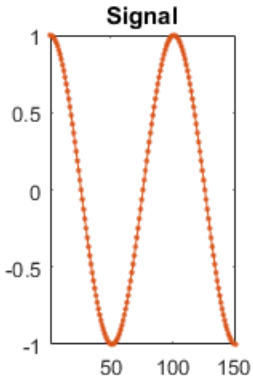

Find Signal in Data with Abrupt Changes

Generate a random data array where:

- The mean is constant in each of seven regions and changes abruptly from region to region.
- The standard deviation is constant in each of five regions and changes abruptly from region to region.

```
lr = 20;
```



```

mns = [0 1 4 -5 2 0 1];
nm = length(mns);

vrs = [1 4 6 1 3]/2;
nv = length(vrs);

v = randn(1,lr*nm*nv);

f = reshape(repmat(mns,lr*nv,1),1,lr*nm*nv);
y = reshape(repmat(vrs,lr*nm,1),1,lr*nm*nv);

t = v.*y+f;

```

Plot the data, highlighting the steps of its construction. Display the mean and standard deviation of each region.

```

subplot(2,2,1)
plot(v)
title('Original')
xlim([0 700])

subplot(2,2,2)
plot([f;v+f]')
title('Means')
xlim([0 700])
text(lr*nv*nm*((0:1/nm:1-1/nm)+1/(2*nm)), -7*ones(1,nm), num2str(mns'))

subplot(2,2,3)
plot([y;v.*y]')
title('STD')
xlim([0 700])
text(lr*nv*nm*((0:1/nv:1-1/nv)+1/(2*nv)), -7*ones(1,nv), num2str(vrs'))

subplot(2,2,4)
plot(t)
title('Final')
xlim([0 700])

```

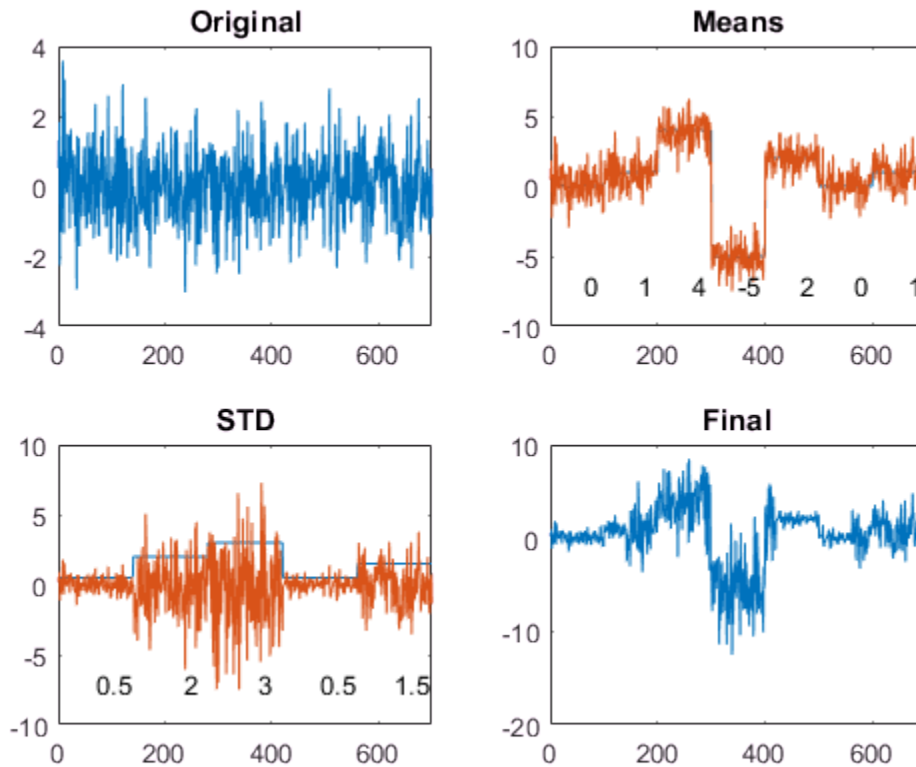

Create a random signal with a mean of zero and a standard deviation of 1/2. Find and display the segment of the data array that best matches the signal.

```
sg = randn(1,2*1r)/2;
```

```
findsignal(t,sg)
```

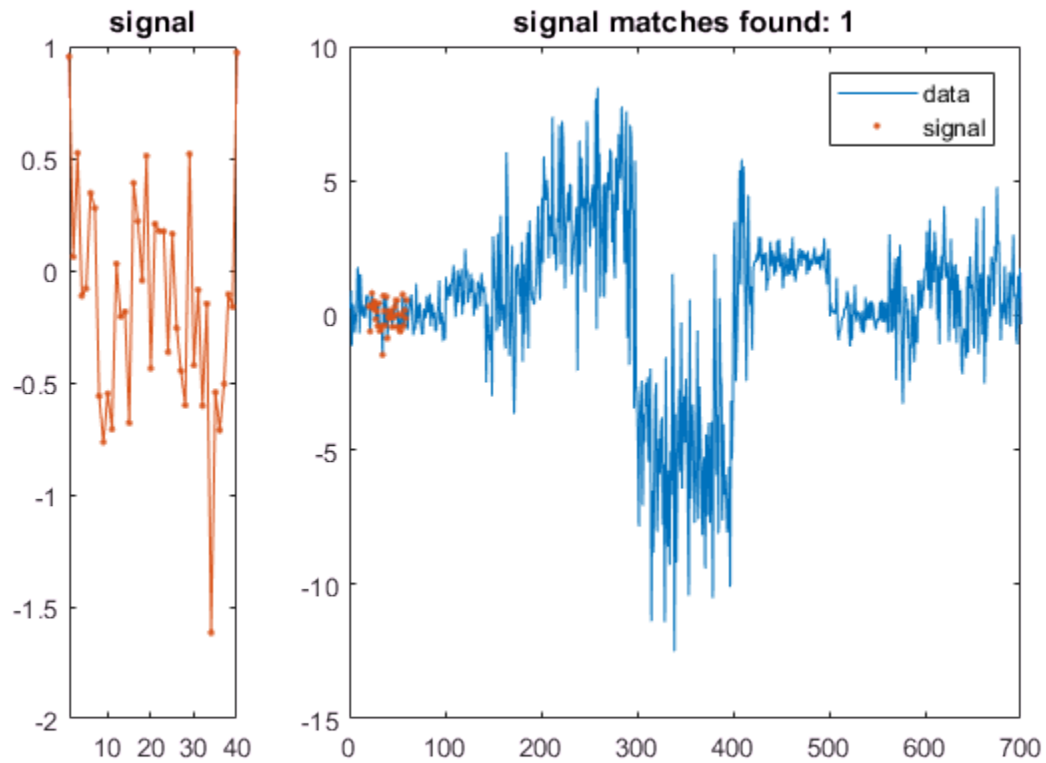

Create a random signal with a mean of zero and a standard deviation of 2. Find and display the segment of the data array that best matches the signal.

```
sg = randn(1,2*lr)*2;
```

```
findsignal(t,sg)
```

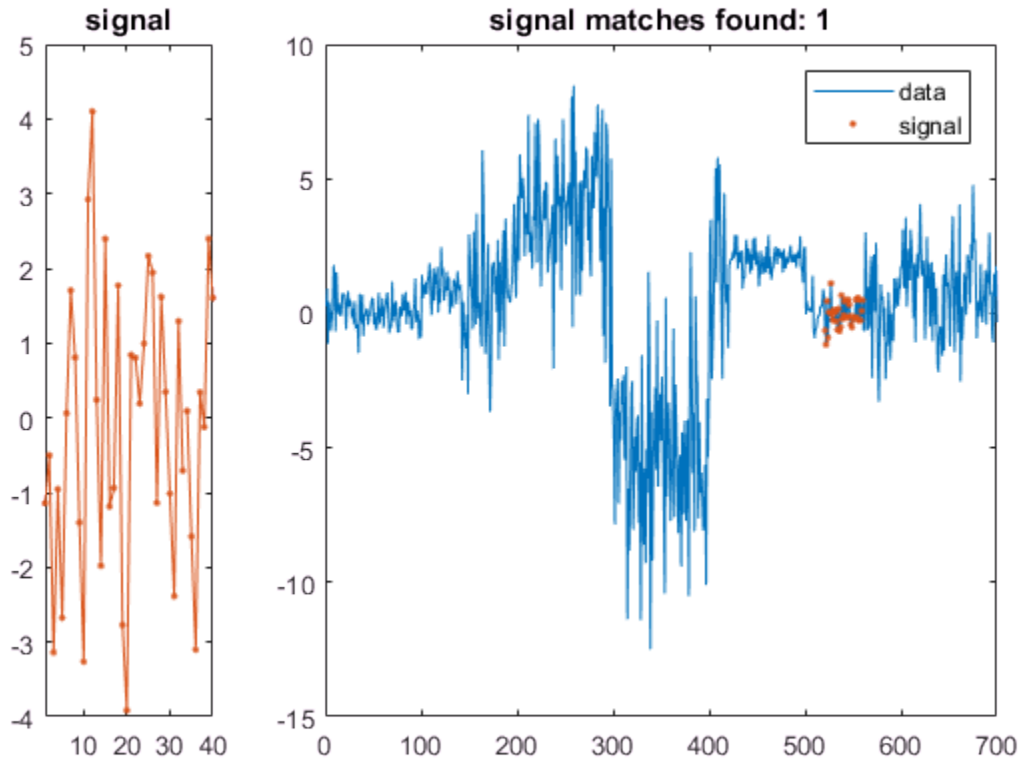

Create a random signal with a mean of 2 and a standard deviation of 2. Find and display the segment of the data array that best matches the signal.

```
sg = randn(1,2*1r)*2+2;
```

```
findsignal(t,sg)
```

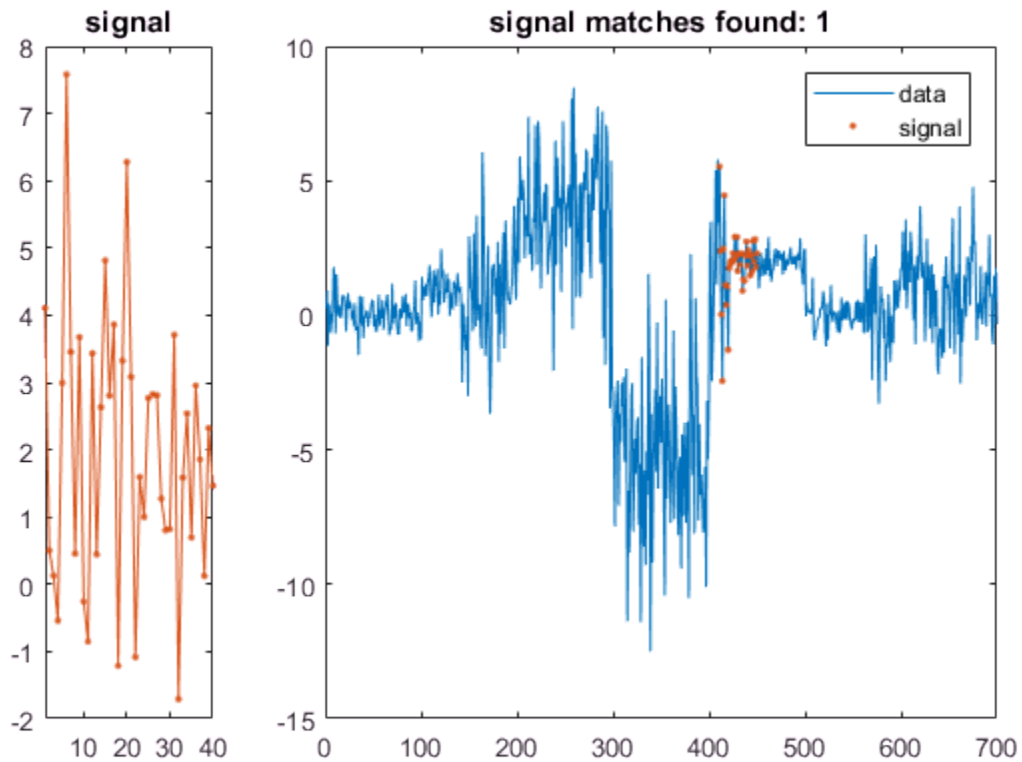

Create a random signal with a mean of -4 and a standard deviation of 3. Find and display the segment of the data array that best matches the signal.

```
sg = randn(1,2*1r)*3-4;
```

```
findsignal(t,sg)
```

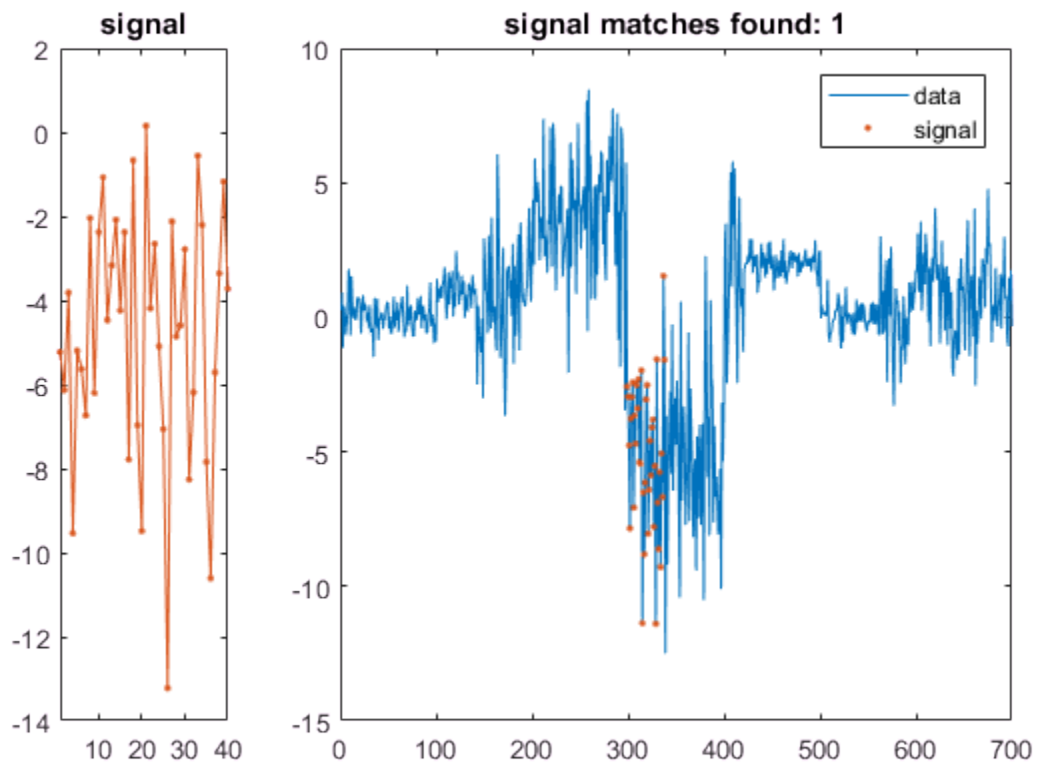

Repeat the calculation, but this time subtract the mean from both the signal and the data.

```
findsignal(t,sg,'Normalization','zscore','Annotate','all')
```

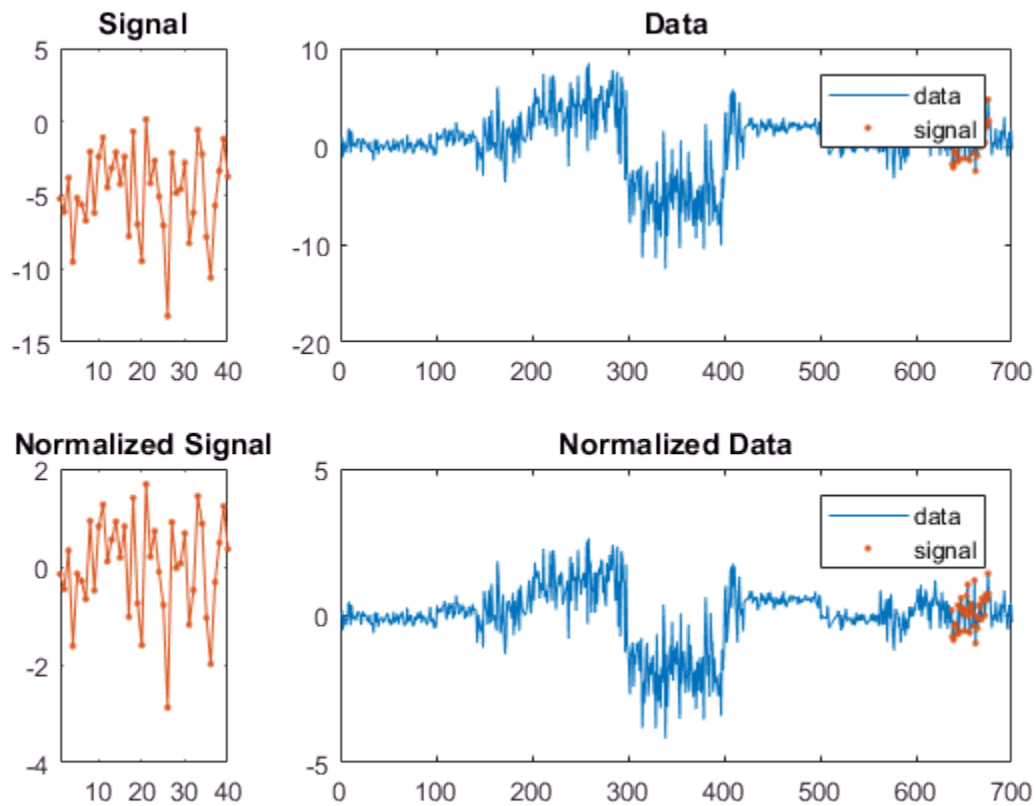

Find Letter in Writing Sample

Devise a typeface that resembles the output of early computers. Use it to write the word MATLAB®.

```
rng default
```

```
chr = @(x)dec2bin(x')-48;
```

```
M = chr([34 34 54 42 34 34 34]);
```

```
A = chr([08 20 34 34 62 34 34]);
```

```
T = chr([62 08 08 08 08 08 08]);
```

```
L = chr([32 32 32 32 32 32 62]);  
B = chr([60 34 34 60 34 34 60]);
```

```
MATLAB = [M A T L A B];
```

Corrupt the word by repeating random columns of the letters and varying the spacing. Show the original word and three corrupted versions.

```
c = @(x)x(:,sort([1:6 randi(6,1,2)]));  
  
subplot(4,1,1,'XLim',[0 60])  
spy(MATLAB)  
xlabel('')  
ylabel('Original')  
  
for kj = 2:4  
    subplot(4,1,kj,'XLim',[0 60])  
    spy([c(M) c(A) c(T) c(L) c(A) c(B)])  
    xlabel('')  
    ylabel('Corrupted')  
end
```

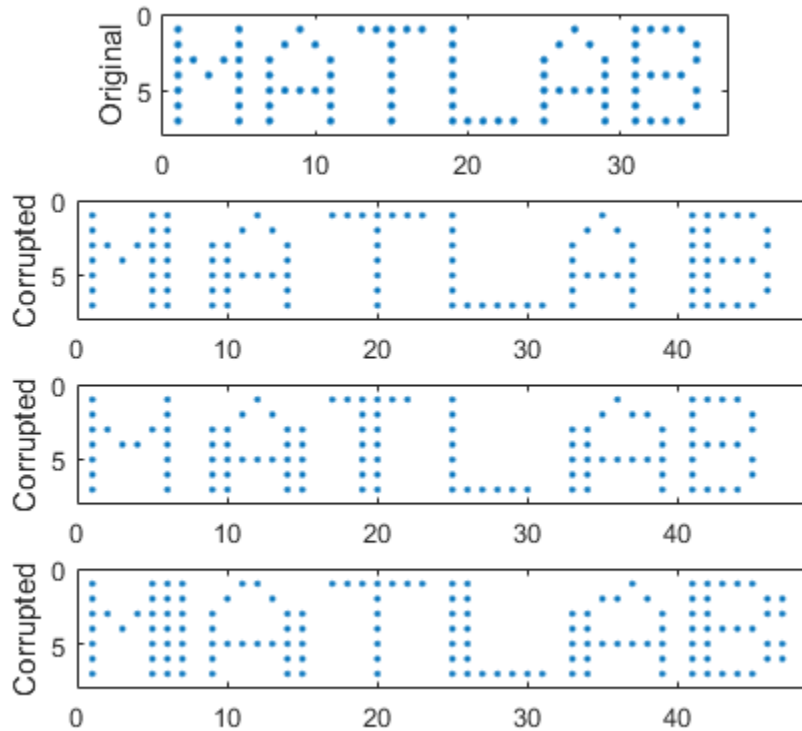
Generate one more corrupted version of the word. Search for a noisy version of the letter "A." Display the distance between the search array and the data segment closest to it. The segment spills into the "T" because the horizontal axes are rigid.

```
corr = [c(M) c(A) c(T) c(L) c(A) c(B)];
sgn = c(A);
[ist,ind,dst] = findsignal(corr,sgn);

clf
subplot(2,1,1)
spy(sgn)
subplot(2,1,2)
```

```
spy(corr)
chk = zeros(size(corr));
chk(:,ist:ind) = corr(:,ist:ind);
hold on
spy(chk, '*k')
hold off
```

dst

dst =

11

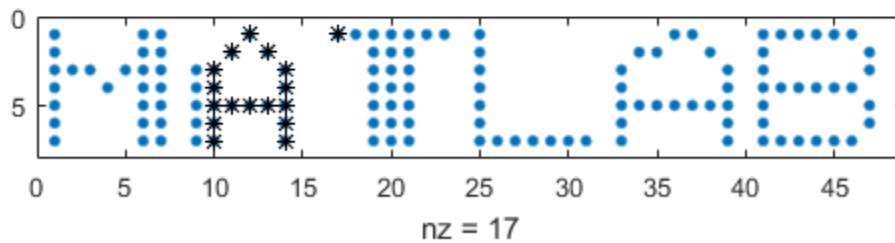
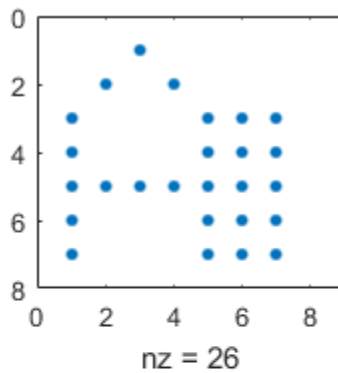

Allow the horizontal axes to stretch. The closest segment is the intersection of the search array and the first instance of "A." The distance between the segment and the array is zero.

```
[ist,ind,dst] = findsignal(corr,sgn,'TimeAlignment','dtw');
```

```
subplot(2,1,1)
spy(sgn)
subplot(2,1,2)
spy(corr)
chk = zeros(size(corr));
chk(:,ist:ind) = corr(:,ist:ind);
hold on
spy(chk,'*k')
hold off
```

```
dst
```

```
dst =
```

```
0
```

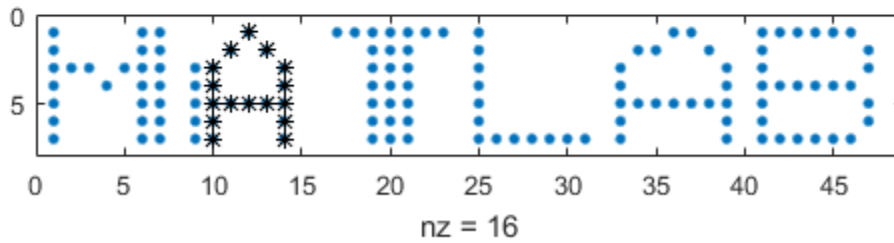
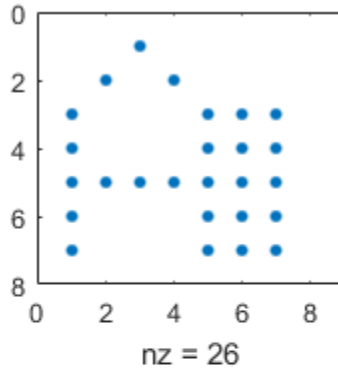

Repeat the computation using the built-in functionality of `findsignal`. Divide by the local mean to normalize the data and the signal. Use the symmetric Kullback-Leibler metric.

```
findsignal(corr,sgn,'TimeAlignment','dtw',...
           'Normalization','power','Metric','symmkl','Annotate','all')
```

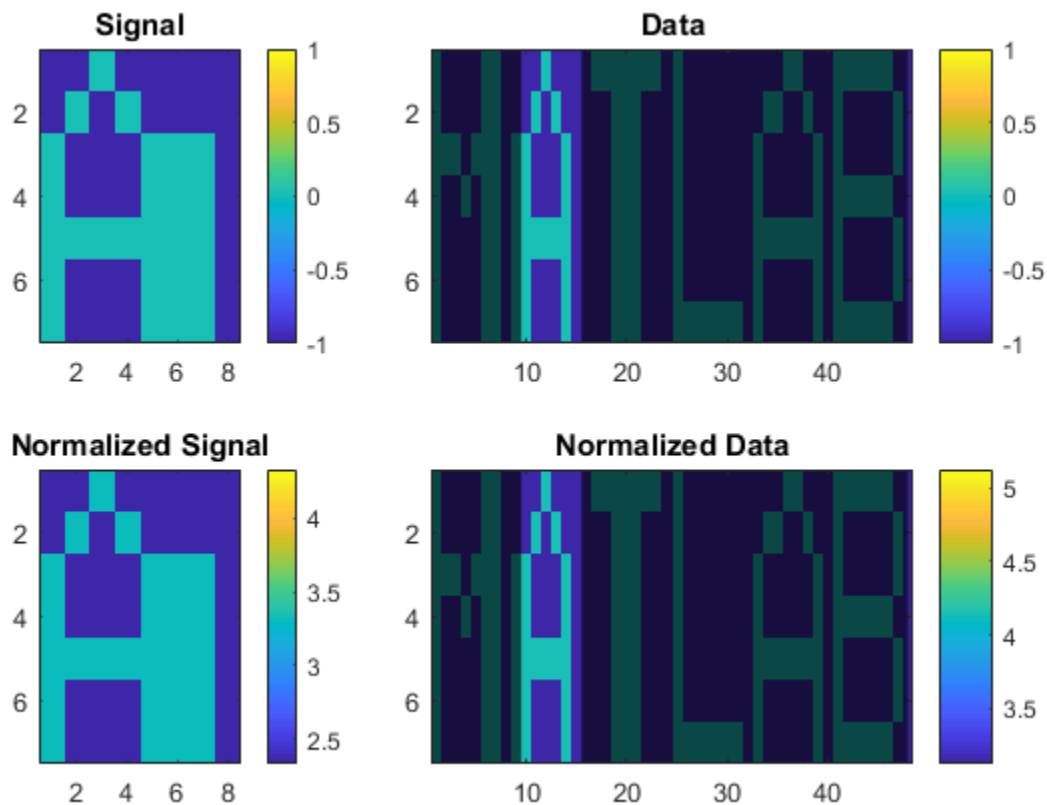

- “Finding a Signal in Data”
- “Find a Signal in a Measurement”

Input Arguments

data — Data array

vector | matrix

Data array, specified as a vector or matrix.

Data Types: `single` | `double`

Complex Number Support: Yes

signal — Search array

vector | matrix

Search array, specified as a vector or matrix.

Data Types: single | double

Complex Number Support: Yes

Name-Value Pair Arguments

Specify optional comma-separated pairs of **Name**, **Value** arguments. **Name** is the argument name and **Value** is the corresponding value. **Name** must appear inside single quotes (' '). You can specify several name and value pair arguments in any order as **Name1**, **Value1**, ..., **NameN**, **ValueN**.

Example:

```
'MaxNumSegments',2,'Metric','squared','Normalization','center','NormalizationLength',5
```

finds the two segments of the data array that have the smallest squared Euclidean distances to the search signal. Both the data and the signal are normalized by subtracting the mean of a sliding window. The window has five samples to either side of each point, for a total length of $5 + 5 + 1 = 11$ samples.

'Normalization' — Normalization statistic

'none' (default) | 'center' | 'power' | 'zscore'

Normalization statistic, specified as the comma-separated pair consisting of 'Normalization' and one of these values:

- 'none' — Do not normalize.
- 'center' — Subtract local mean.
- 'power' — Divide by local mean.
- 'zscore' — Subtract local mean and divide by local standard deviation.

Data Types: char

'NormalizationLength' — Normalization length

length(data) (default) | integer scalar

Normalization length, specified as the comma-separated pair consisting of 'NormalizationLength' and an integer scalar. This value represents the minimum

number of samples over which to normalize each sample in both the data and the signal. If the signal is a matrix, then `'NormalizationLength'` represents a number of columns.

Data Types: `single` | `double`

'MaxDistance' — Maximum segment distance

`Inf` (default) | positive real scalar

Maximum segment distance, specified as the comma-separated pair consisting of `'MaxDistance'` and a positive real scalar. If you specify `'MaxDistance'`, then `findsignal` returns the start and stop indices of all segments of data whose distances from `signal` are both local minima and smaller than `'MaxDistance'`.

Data Types: `single` | `double`

'MaxNumSegments' — Maximum number of segments to return

`1` (default) | positive integer scalar

Maximum number of segments to return, specified as the comma-separated pair consisting of `'MaxNumSegments'` and a positive integer scalar. If you specify `'MaxNumSegments'`, then `findsignal` locates all segments of data whose distances from the signal are local minima and returns up to `'MaxNumSegments'` segments with smallest distances.

Data Types: `single` | `double`

'TimeAlignment' — Time alignment technique

`'fixed'` (default) | `'dtw'` | `'edr'`

Time alignment technique, specified as the comma-separated pair consisting of `'TimeAlignment'` and one of these values:

- `'fixed'` — Do not stretch or repeat samples to minimize the distance.
- `'dtw'` — Attempt to reduce the distance by stretching the time axis and repeating samples in either the data or the signal. See `dtw` for more information.
- `'edr'` — Minimize the number of edits so that the distance between each remaining sample of the data segment and its signal counterpart lies within a given tolerance. An edit consists of removing a sample from the data, the signal, or both. Specify the tolerance using the `'EDRTolerance'` argument. Use this option when any of the input arrays has outliers. See `edr` for more information.

Data Types: char

'EDRTolerance' — Edit distance tolerance

real scalar

Edit distance tolerance, specified as the comma-separated pair consisting of 'EDRTolerance' and a real scalar. Use this argument to find the signal when the 'TimeAlignment' name-value pair argument is set to 'edr'.

Data Types: single | double

'Metric' — Distance metric

'euclidean' (default) | 'absolute' | 'squared' | 'symmk1'

Distance metric, specified as the comma-separated pair consisting of 'Metric' and one of 'euclidean', 'absolute', 'squared', or 'symmk1'. If \mathbf{X} and \mathbf{Y} are both K -dimensional signals, then `Metric` prescribes $d_{mn}(\mathbf{X}, \mathbf{Y})$, the distance between the m th sample of \mathbf{X} and the n th sample of \mathbf{Y} . See “Dynamic Time Warping” on page 1-473 for more information about $d_{mn}(\mathbf{X}, \mathbf{Y})$.

- 'euclidean' — Root sum of squared differences, also known as the Euclidean or ℓ_2 metric:

$$d_{mn}(\mathbf{X}, \mathbf{Y}) = \sqrt{\sum_{k=1}^K (x_{k,m} - y_{k,n})^* (x_{k,m} - y_{k,n})}$$

- 'absolute' — Sum of absolute differences, also known as the Manhattan, city block, taxicab, or ℓ_1 metric:

$$d_{mn}(\mathbf{X}, \mathbf{Y}) = \sum_{k=1}^K |x_{k,m} - y_{k,n}| = \sum_{k=1}^K \sqrt{(x_{k,m} - y_{k,n})^* (x_{k,m} - y_{k,n})}$$

- 'squared' — Square of the Euclidean metric, consisting of the sum of squared differences:

$$d_{mn}(\mathbf{X}, \mathbf{Y}) = \sum_{k=1}^K (x_{k,m} - y_{k,n})^* (x_{k,m} - y_{k,n})$$

- 'symmk1' — Symmetric Kullback-Leibler metric. This metric is valid only for real and positive \mathbf{X} and \mathbf{Y} :

$$d_{mn}(\mathbf{X}, \mathbf{Y}) = \sum_{k=1}^K (x_{k,m} - y_{k,n}) (\log x_{k,m} - \log y_{k,n})$$

Data Types: char

'Annotate' — Plot style

'signal' (default) | 'data' | 'all'

Plot style, specified as the comma-separated pair consisting of 'Annotate' and one of these values:

- 'data' plots the data and highlights the regions that best match the signal.
- 'signal' plots the signal in a separate subplot.
- 'all' plots the signal, the data, the normalized signal, and the normalized data in separate subplots.

This argument is ignored if you call `findsignal` with output arguments.

Output Arguments

istart, istop — Segment start and end indices

integer scalars | vectors

Segment start and end indices, returned as integer scalars or vectors.

dist — Minimum data-signal distance

scalar | vector

Minimum data-signal distance, returned as a scalar or a vector.

See Also

See Also

`alignsignals` | `dtw` | `edr` | `finddelay` | `findpeaks` | `strfind` | `xcorr`

Topics

“Finding a Signal in Data”

“Find a Signal in a Measurement”

Introduced in R2016b

fir1

Window-based FIR filter design

Syntax

```
b = fir1(n,Wn)
b = fir1(n,Wn,ftype)

b = fir1( ____,window)
b = fir1( ____,scaleopt)
```

Description

`b = fir1(n,Wn)` uses a Hamming window to design an n th-order lowpass, bandpass, or multiband FIR filter with linear phase. The filter type depends on the number of elements of `Wn`.

`b = fir1(n,Wn,ftype)` designs a lowpass, highpass, bandpass, bandstop, or multiband filter, depending on the value of `ftype` and the number of elements of `Wn`.

`b = fir1(____,window)` designs the filter using the vector specified in `window` and any of the arguments from previous syntaxes.

`b = fir1(____,scaleopt)` additionally specifies whether or not the magnitude response of the filter is normalized.

Note: Use `fir2` for windowed filters with arbitrary frequency response.

Examples

FIR Bandpass Filter

Design a 48th-order FIR bandpass filter with passband $0.35\pi \leq \omega \leq 0.65\pi$ rad/sample. Visualize its magnitude and phase responses.

```
b = fir1(48,[0.35 0.65]);
freqz(b,1,512)
```

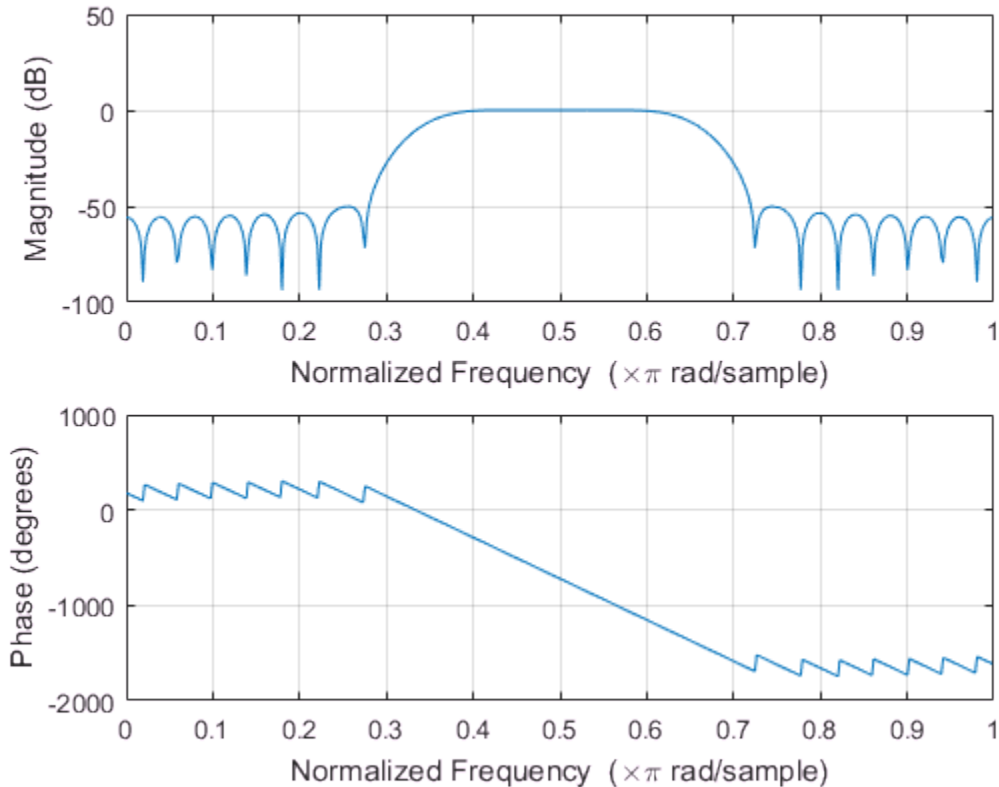

FIR Highpass Filter

Load `chirp.mat`. The file contains a signal, `y`, that has most of its power above $F_s/4$, or half the Nyquist frequency. The sample rate is 8192 Hz.

Design a 34th-order FIR highpass filter to attenuate the components of the signal below $F_s/4$. Use a cutoff frequency of 0.48 and a Chebyshev window with 30 dB of ripple.

```
load chirp

t = (0:length(y)-1)/Fs;

bhi = fir1(34,0.48,'high',chebwin(35,30));
freqz(bhi,1)
```

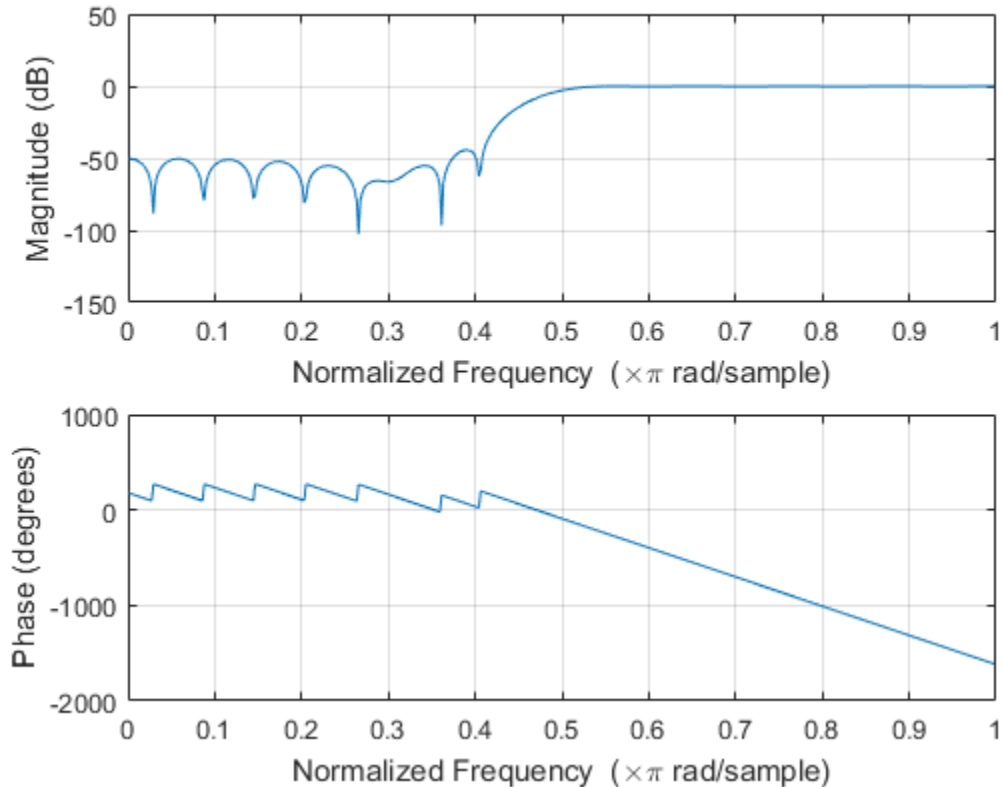

Filter the signal. Display the original and highpass-filtered signals. Use the same y-axis scale for both plots.

```
outhi = filter(bhi,1,y);

subplot(2,1,1)
plot(t,y)
title('Original Signal')
ys = ylim;

subplot(2,1,2)
plot(t,outhi)
title('Highpass Filtered Signal')
xlabel('Time (s)')
```

```
ylim(ys)
```

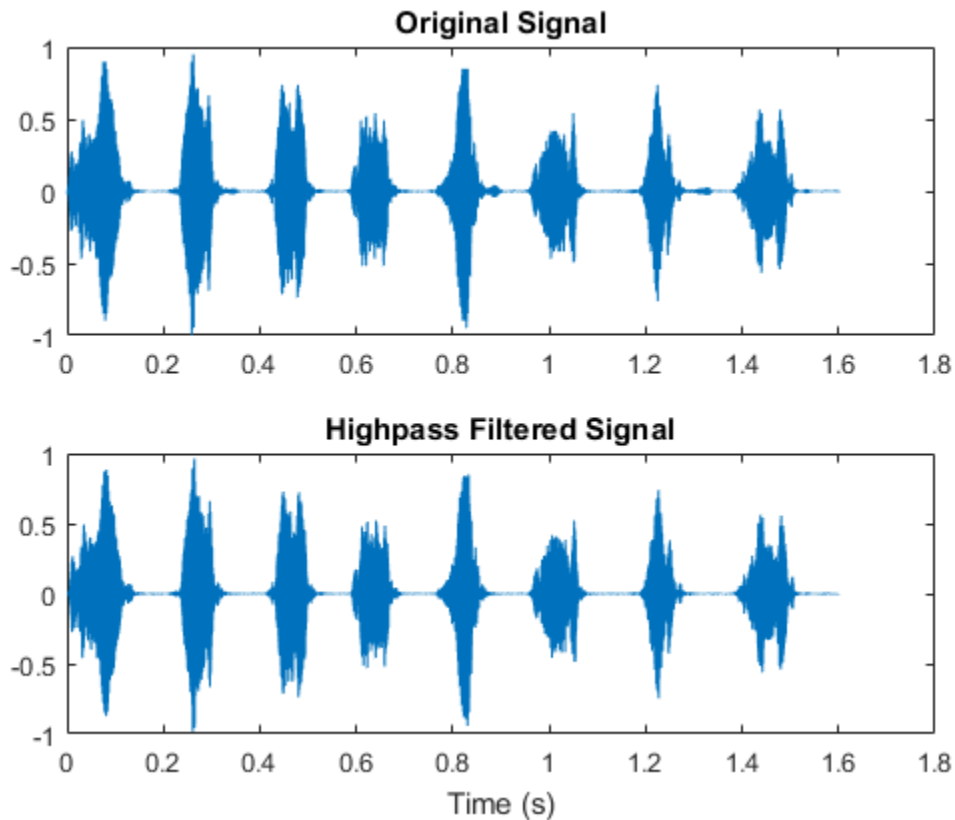

Design a lowpass filter with the same specifications. Filter the signal and compare the result to the original. Use the same y-axis scale for both plots.

```
blo = fir1(34,0.48,chebwin(35,30));  
  
outlo = filter(blo,1,y);  
  
subplot(2,1,1)  
plot(t,y)  
title('Original Signal')  
ys = ylim;
```

```
subplot(2,1,2)
plot(t,outlo)
title('Lowpass Filtered Signal')
xlabel('Time (s)')
ylim(ys)
```

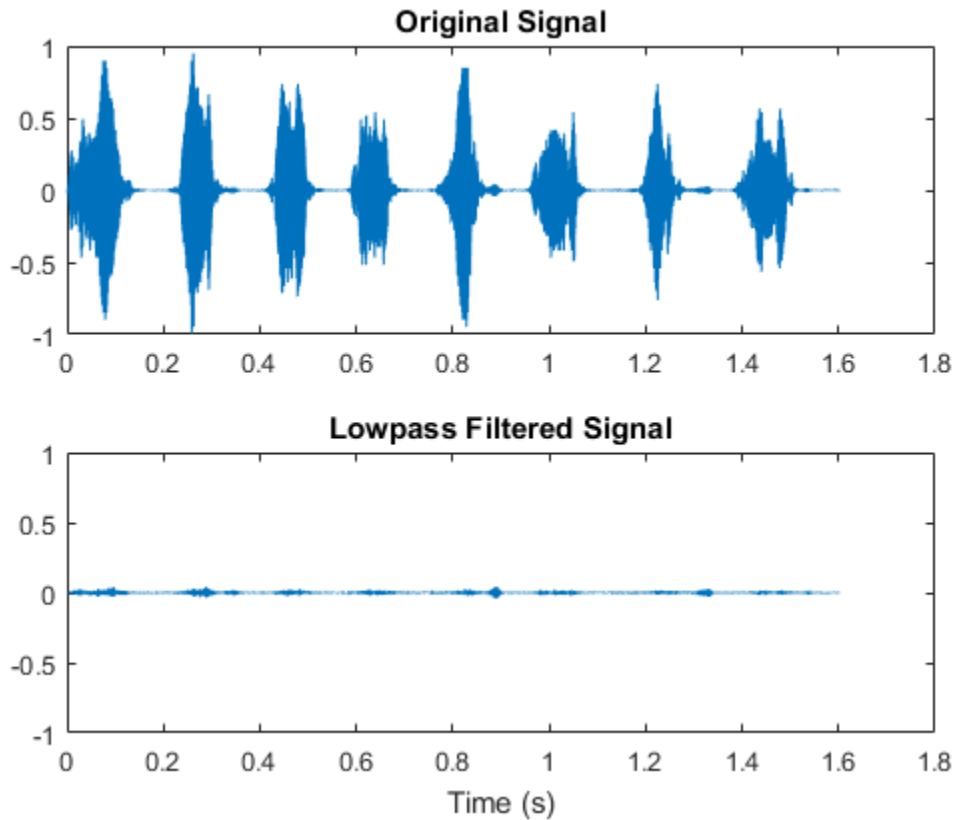

Multiband FIR Filter

Design a 46th-order FIR filter that attenuates normalized frequencies below 0.4π rad/sample and between 0.6π and 0.9π rad/sample. Call it bM.

```
ord = 46;
```

```
low = 0.4;  
bnd = [0.6 0.9];  
  
bM = fir1(ord,[low bnd]);
```

Redesign `bM` so that it passes the bands it was attenuating and stops the other frequencies. Call the new filter `bW`. Use `fvtool` to display the frequency responses of the filters.

```
bW = fir1(ord,[low bnd], 'DC-1');  
  
hfvt = fvtool(bM,1,bW,1);  
legend(hfvt, 'bM', 'bW')
```

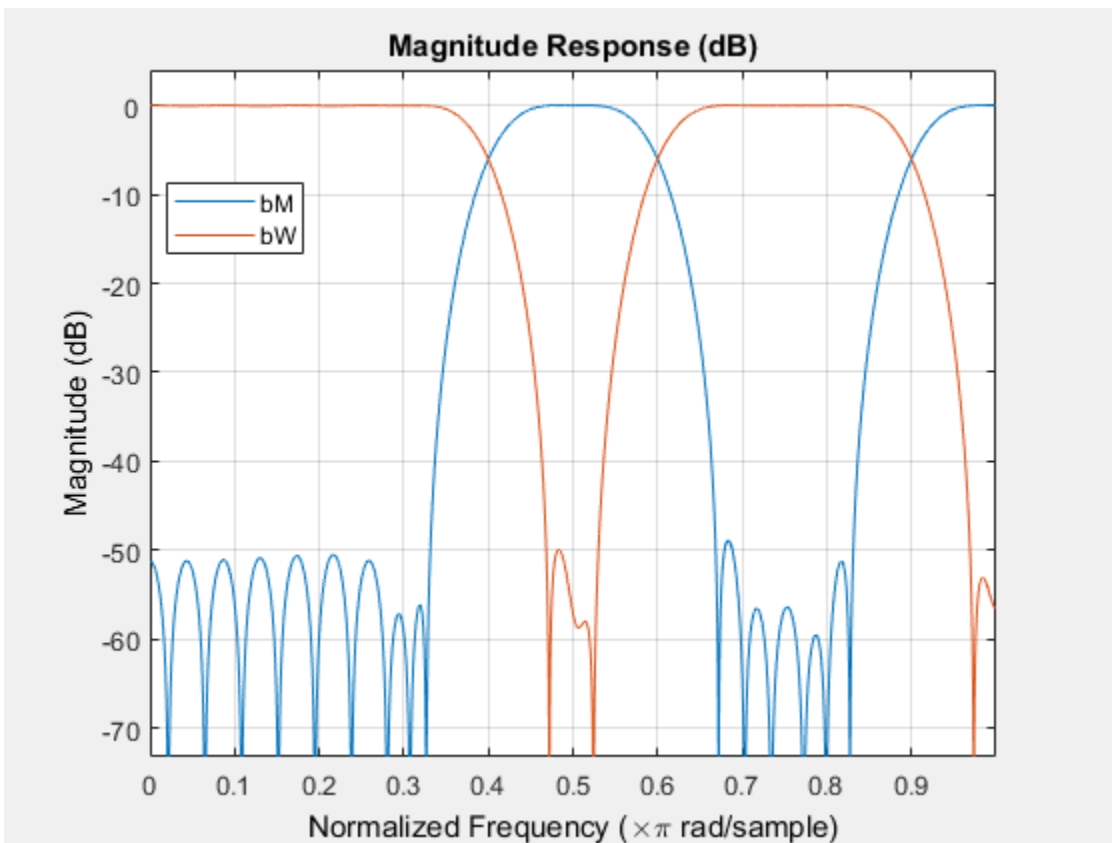

Redesign bM using a Hann window. (The 'DC-0' is optional.) Compare the magnitude responses of the Hamming and Hann designs.

```
hM = fir1(ord,[low bnd], 'DC-0', hann(ord+1));
hfvt = fvtool(bM,1,hM,1);
legend(hfvt, 'Hamming', 'Hann')
```

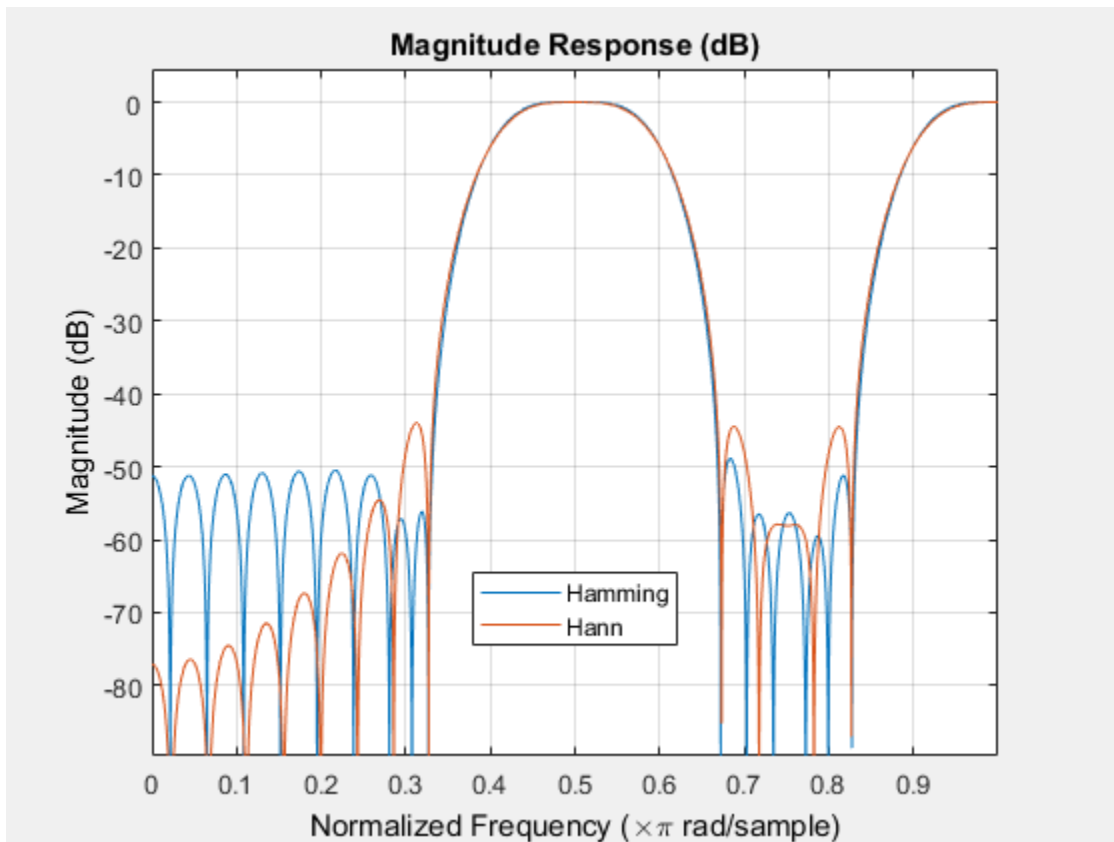

Redesign bW using a Tukey window. Compare the magnitude responses of the Hamming and Tukey designs.

```
tW = fir1(ord,[low bnd], 'DC-1', tukeywin(ord+1));
```

```
hfvt = fvtool(bW,1,tW,1);  
legend(hfvt, 'Hamming', 'Tukey')
```

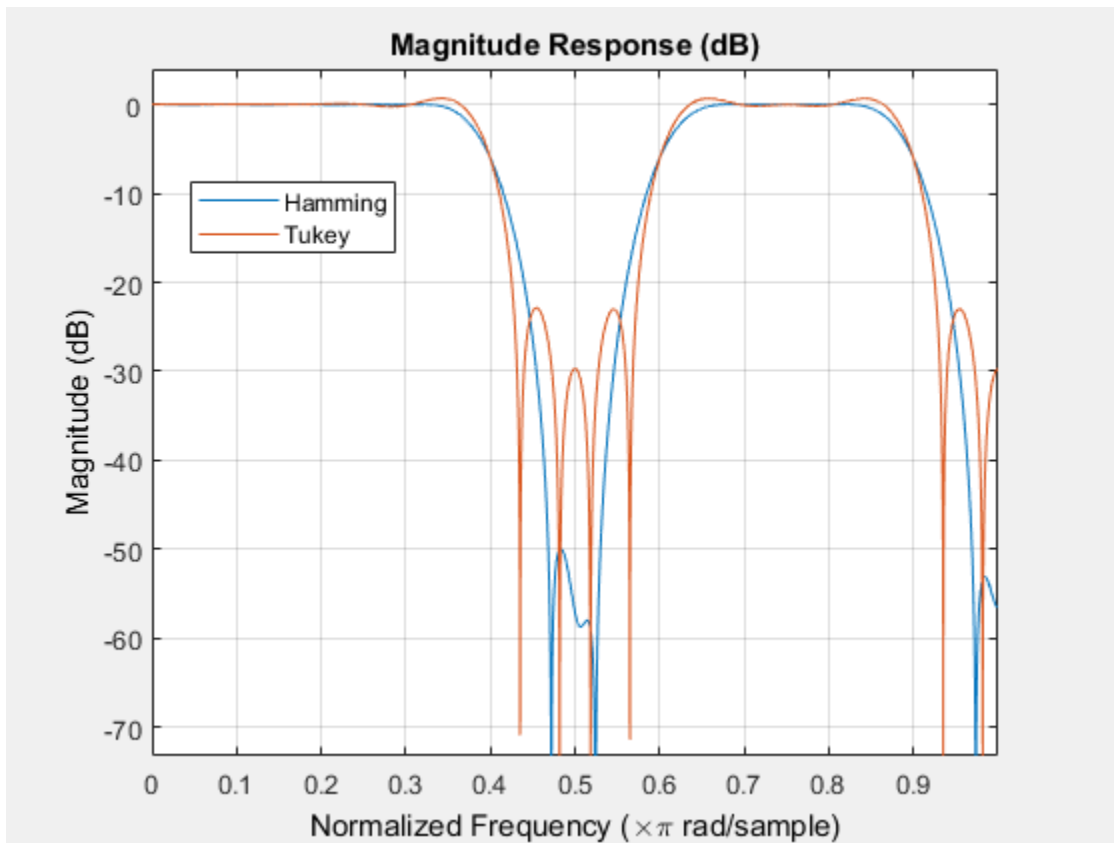

Input Arguments

n — Filter order
integer scalar

Filter order, specified as an integer scalar.

For highpass and bandstop configurations, `fir1` always uses an even filter order. The order must be even because odd-order symmetric FIR filters must have zero gain at the Nyquist frequency. If you specify an odd `n` for a highpass or bandstop filter, then `fir1` increments `n` by 1.

Data Types: `double`

Wn — Frequency constraints

scalar | two-element vector | multi-element vector

Frequency constraints, specified as a scalar, a two-element vector, or a multi-element vector. All elements of `Wn` must be strictly greater than 0 and strictly smaller than 1, where 1 corresponds to the Nyquist frequency: $0 < Wn < 1$. The Nyquist frequency is half the sample rate or π rad/sample.

- If `Wn` is a scalar, then `fir1` designs a lowpass or highpass filter with cutoff frequency `Wn`. The cutoff frequency is the frequency at which the normalized gain of the filter is -6 dB.
- If `Wn` is the two-element vector `[w1 w2]`, where $w1 < w2$, then `fir1` designs a bandpass or bandstop filter with lower cutoff frequency `w1` and higher cutoff frequency `w2`.
- If `Wn` is the multi-element vector `[w1 w2 ... wn]`, where $w1 < w2 < \dots < wn$, then `fir1` returns an `n`th-order multiband filter with bands $0 < \omega < w1$, $w1 < \omega < w2$, ..., $wn < \omega < 1$.

Data Types: `double`

ftype — Filter type

'low' | 'bandpass' | 'high' | 'stop' | 'DC-0' | 'DC-1'

Filter type, specified as one of the following:

- 'low' specifies a lowpass filter with cutoff frequency `Wn`. 'low' is the default for scalar `Wn`.
- 'high' specifies a highpass filter with cutoff frequency `Wn`.
- 'bandpass' specifies a bandpass filter if `Wn` is a two-element vector. 'bandpass' is the default when `Wn` has two elements.
- 'stop' specifies a bandstop filter if `Wn` is a two-element vector.
- 'DC-0' specifies that the first band of a multiband filter is a stopband. 'DC-0' is the default when `Wn` has more than two elements.

- 'DC-1' specifies that the first band of a multiband filter is a passband.

Data Types: char

window — Window

vector

Window, specified as a vector. The window vector must have $n + 1$ elements. If you do not specify `window`, then `fir1` uses a Hamming window. For a list of available windows, see “Windows”.

`fir1` does not automatically increase the length of `window` if you attempt to design a highpass or bandstop filter of odd order.

Example: `kaiser(n+1,0.5)` specifies a Kaiser window with shape parameter 0.5 to use with a filter of order n .

Example: `hamming(n+1)` is equivalent to leaving the window unspecified.

Data Types: double

scaleopt — Normalization option

'scale' (default) | 'noscale'

Normalization option, specified as either 'scale' or 'noscale'.

- 'scale' normalizes the coefficients so that the magnitude response of the filter at the center of the passband is 1 (0 dB).
- 'noscale' does not normalize the coefficients.

Data Types: char

Output Arguments

b — Filter coefficients

row vector

Filter coefficients, returned as a row vector of length $n + 1$. The coefficients are sorted in descending powers of the Z-transform variable z :

$$B(z) = b(1) + b(2)z + \dots + b(n+1)z^{-n}.$$

Algorithms

`fir1` uses a least-squares approximation to compute the filter coefficients and then smooths the impulse response with `window`.

References

- [1] Digital Signal Processing Committee of the IEEE Acoustics, Speech, and Signal Processing Society, eds. *Programs for Digital Signal Processing*. New York: IEEE Press, 1979, Algorithm 5.2.

Extended Capabilities

C/C++ Code Generation

Generate C and C++ code using MATLAB® Coder™.

Usage notes and limitations:

All inputs must be constants. Expressions or variables are allowed if their values do not change.

See Also

See Also

`cfirpm` | `designfilt` | `filter` | `fir2` | `fircls` | `fircls1` | `firls` | `firpm` | `freqz` | `hamming` | `kaiserord` | `window`

Introduced before R2006a

fir2

Frequency sampling-based FIR filter design

Syntax

```
b = fir2(n,f,m)
b = fir2(n,f,m,npt,lap)
b = fir2(___,window)
```

Description

`b = fir2(n,f,m)` returns an n th-order FIR filter with frequency-magnitude characteristics specified in the vectors `f` and `m`. The function linearly interpolates the desired frequency response onto a dense grid and then uses the inverse Fourier transform and a Hamming window to obtain the filter coefficients.

`b = fir2(n,f,m,npt,lap)` specifies `npt`, the number of points in the interpolation grid, and `lap`, the length of the region that `fir2` inserts around duplicate frequency points which specify steps in the frequency response.

`b = fir2(___,window)` specifies a window vector to use in the design in addition to any input arguments from previous syntaxes.

Note: Use `fir1` for window-based standard lowpass, bandpass, highpass, bandstop, and multiband configurations.

Examples

Attenuation of Low Frequencies

Load the MAT-file `chirp`. The file contains a signal, `y`, sampled at a frequency `Fs = 8192 Hz`. `y` has most of its power above $F_s/4$, or half the Nyquist frequency. Add random noise to the signal.

```
load chirp
y = y + 0.25*(rand(size(y))-0.5);
```

Design a 34th-order FIR highpass filter to attenuate the components of the signal below $F_s/4$. Specify a cutoff frequency of 0.48. Visualize the frequency response of the filter.

```
f = [0 0.48 0.48 1];
mhi = [0 0 1 1];
bhi = fir2(34,f,mhi);

freqz(bhi,1)
```

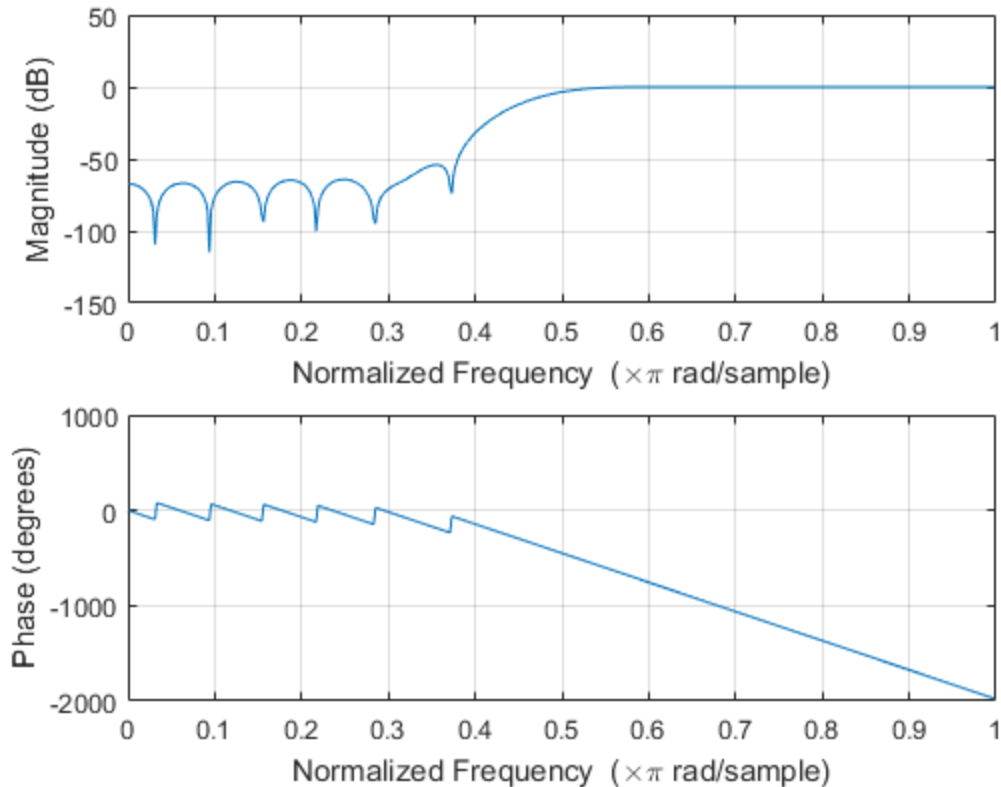

Filter the chirp signal. Plot the signal before and after filtering.

```
outhi = filter(bhi,1,y);
t = (0:length(y)-1)/Fs;
```

```
subplot(2,1,1)
plot(t,y)
title('Original Signal')
ylim([-1.2 1.2])

subplot(2,1,2)
plot(t,outhi)
title('Higpass Filtered Signal')
xlabel('Time (s)')
ylim([-1.2 1.2])
```

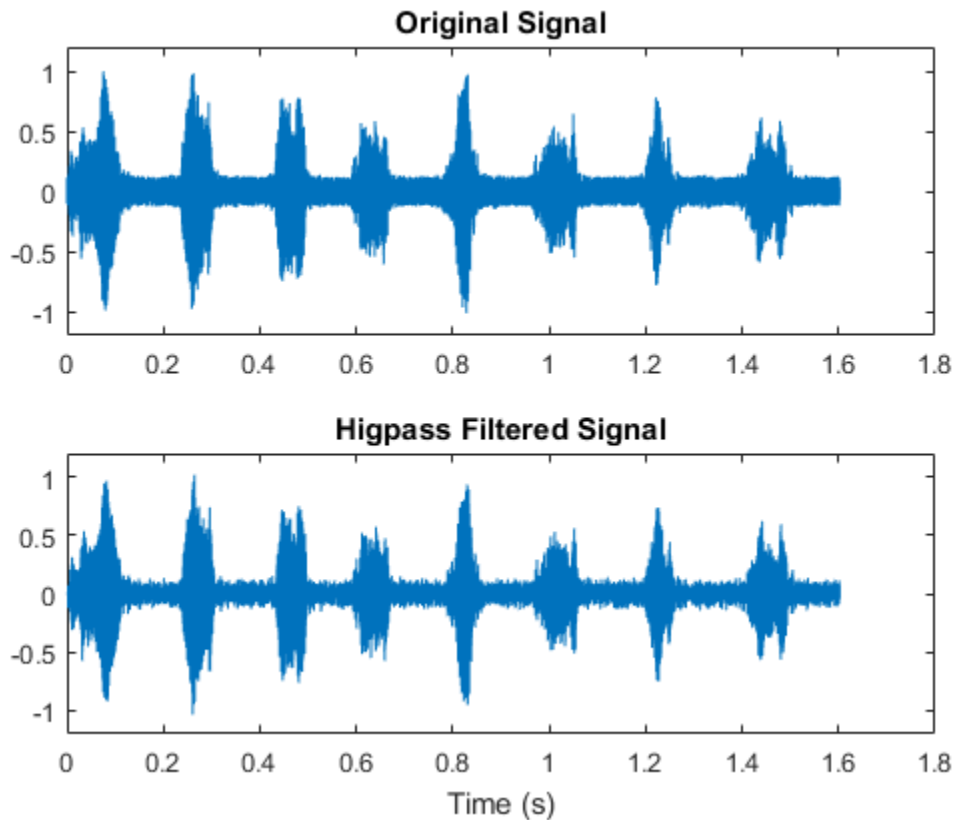

Change the filter from highpass to lowpass. Use the same order and cutoff. Filter the signal again. The result is mostly noise.

```
mlo = [1 1 0 0];  
blo = fir2(34,f,mlo);  
outlo = filter(blo,1,y);  
  
subplot(2,1,1)  
plot(t,y)  
title('Original Signal')  
ylim([-1.2 1.2])  
  
subplot(2,1,2)  
plot(t,outlo)  
title('Lowpass Filtered Signal')  
xlabel('Time (s)')  
ylim([-1.2 1.2])
```

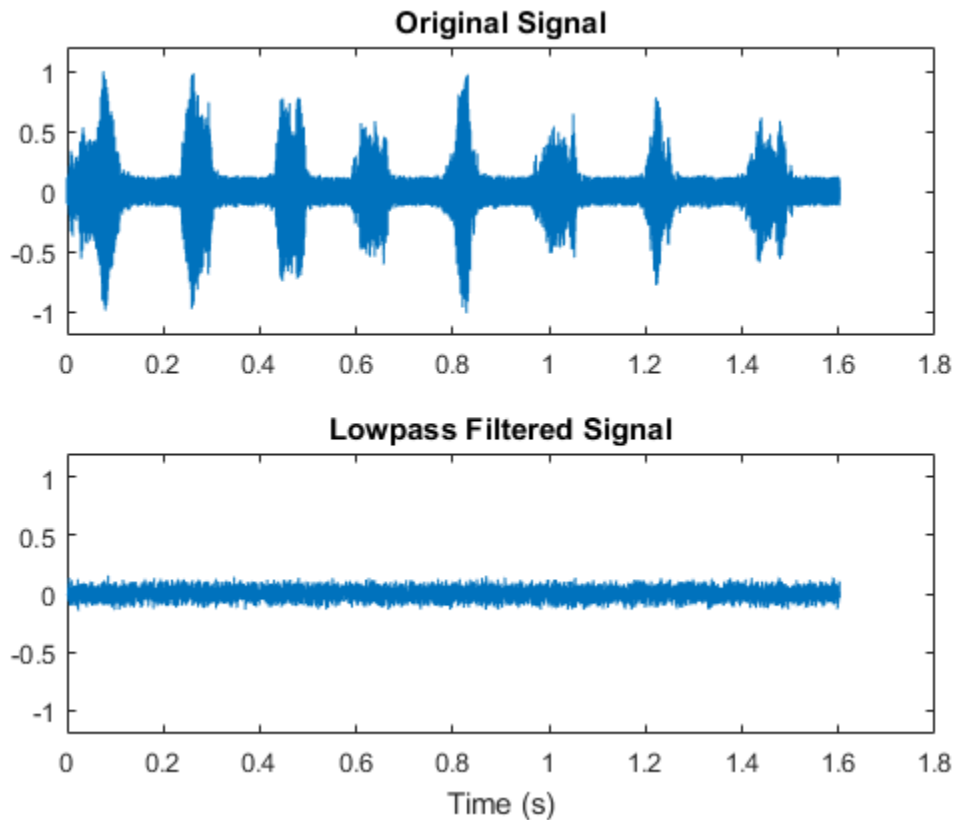

FIR Lowpass Filter

Design a 30th-order lowpass filter with a normalized cutoff frequency of 0.6π rad/sample. Plot the ideal frequency response overlaid with the actual frequency response.

```
f = [0 0.6 0.6 1];  
m = [1 1 0 0];  
  
b1 = fir2(30,f,m);  
[h1,w] = freqz(b1,1);  
  
plot(f,m,w/pi,abs(h1))  
xlabel('\omega / \pi')
```

```
lgs = {'Ideal', 'fir2 default'};  
legend(lgs)
```

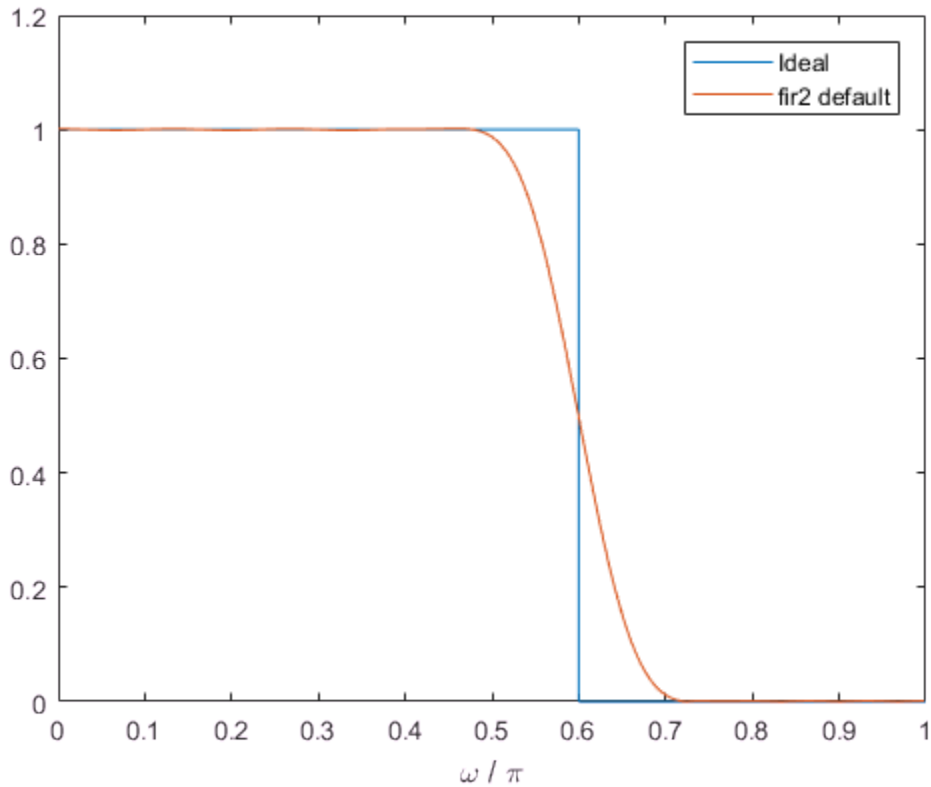

Redesign the filter using a 64-point interpolation grid.

```
b2 = fir2(30,f,m,64);  
h2 = freqz(b2,1);
```

```
hold on  
plot(w/pi,abs(h2))  
lgs{3} = 'npt = 64';  
legend(lgs)
```

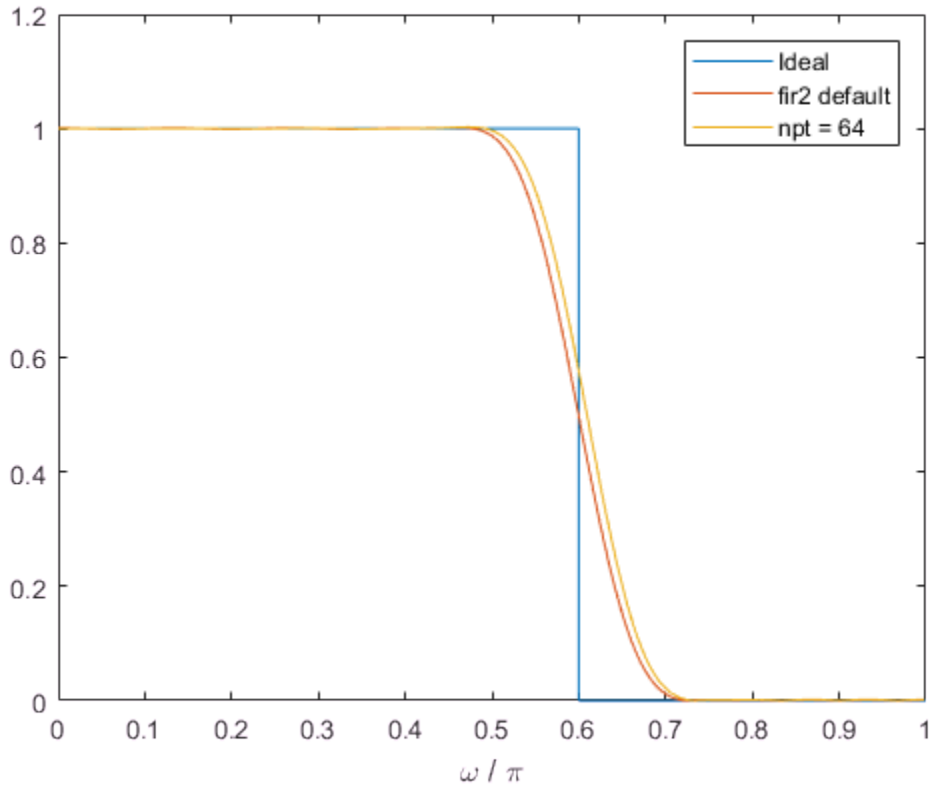

Redesign the filter using the 64-point interpolation grid and a 13-point interval around the cutoff frequency.

```

b3 = fir2(30,f,m,64,13);
h3 = freqz(b3,1);

plot(w/pi,abs(h3))
lgs{4} = 'lap = 13';
legend(lgs)
    
```

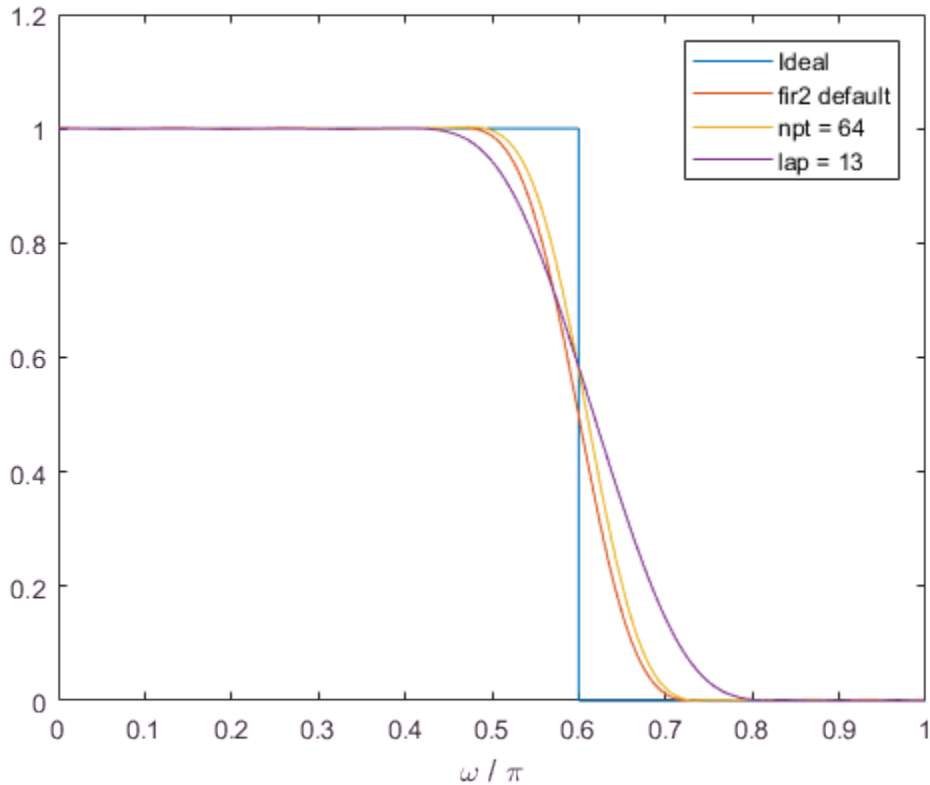

Arbitrary Magnitude Filter

Design an FIR filter with the following frequency response:

- A sinusoid between 0 and 0.18π rad/sample.

```
F1 = 0:0.01:0.18;
A1 = 0.5+sin(2*pi*7.5*F1)/4;
```

- A piecewise linear section between 0.2π rad/sample and 0.78π rad/sample.

```
F2 = [0.2 0.38 0.4 0.55 0.562 0.585 0.6 0.78];
```

```
A2 = [0.5 2.3 1 1 -0.2 -0.2 1 1];
```

- A quadratic section between 0.79π rad/sample and the Nyquist frequency.

```
F3 = 0.79:0.01:1;
A3 = 0.2+18*(1-F3).^2;
```

Design the filter using a Hamming window. Specify a filter order of 50.

```
N = 50;

FreqVect = [F1 F2 F3];
AmplVect = [A1 A2 A3];

ham = fir2(N,FreqVect,AmplVect);
```

Repeat the calculation using a Kaiser window that has a shape parameter of 3.

```
kai = fir2(N,FreqVect,AmplVect,kaiser(N+1,3));
```

Redesign the filter using the `designfilt` function. `designfilt` uses a rectangular window by default. Compute the zero-phase response of the filter over 1024 points.

```
d = designfilt('arbmagfir','FilterOrder',N, ...
    'Frequencies',FreqVect,'Amplitudes',AmplVect);

[zd,wd] = zerophase(d,1024);
```

Display the zero-phase responses of the three filters. Overlay the ideal response.

```
zerophase(ham,1)
hold on
zerophase(kai,1)
plot(wd/pi,zd)
plot(FreqVect,AmplVect,'k:')
legend('Hamming','Kaiser','designfilt','ideal')
```

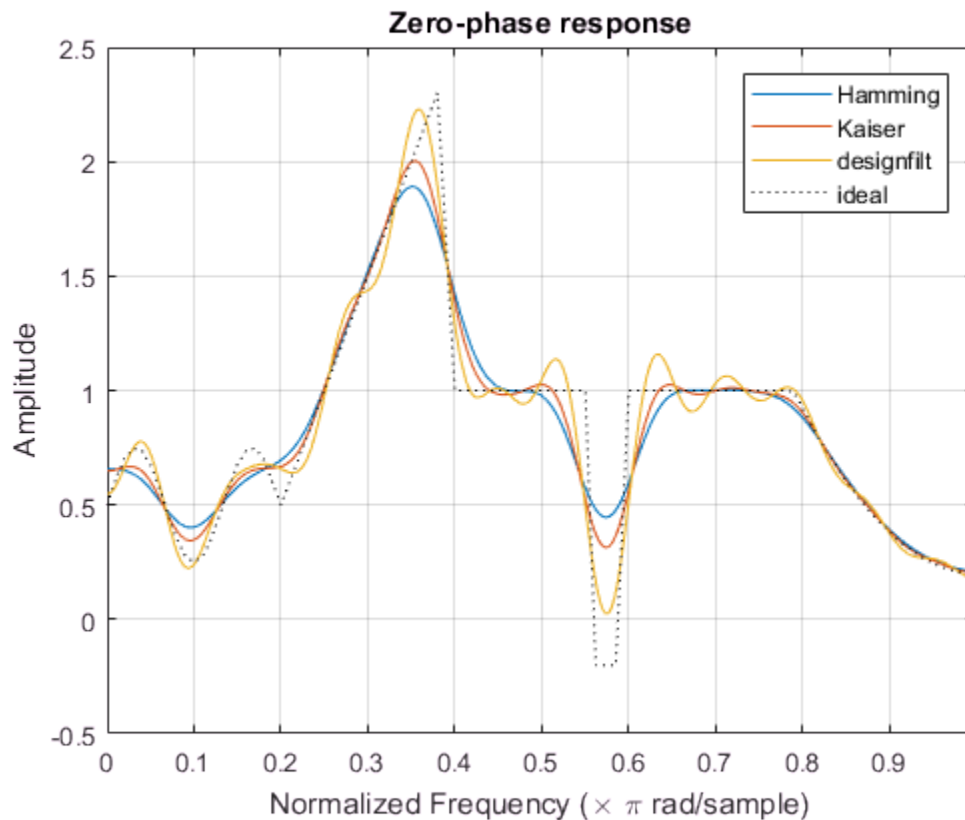

Input Arguments

n — Filter order
integer scalar

Filter order, specified as an integer scalar.

For configurations with a passband at the Nyquist frequency, `fir2` always uses an even order. If you specify an odd-valued `n` for one of those configurations, then `fir2` increments `n` by 1.

Data Types: double

f, m — Frequency-magnitude characteristics

vectors

Frequency-magnitude characteristics, specified as vectors of the same length.

- **f** is a vector of frequency points in the range from 0 to 1, where 1 corresponds to the Nyquist frequency. The first point of **f** must be 0 and the last point must be 1. **f** must be sorted in increasing order. Duplicate frequency points are allowed and are treated as steps in the frequency response.
- **m** is a vector containing the desired magnitude response at each of the points specified in **f**.

Data Types: double

npt — Number of grid points

512 (default) | positive integer scalar

Number of grid points, specified as a positive integer scalar. **npt** must be larger than one-half the filter order: $npt > n/2$.

Data Types: double

lap — Length of region around duplicate frequency points

25 (default) | positive integer scalar

Length of region around duplicate frequency points, specified as a positive integer scalar.

Data Types: double

window — Window

column vector

Window, specified as a column vector. The window vector must have $n + 1$ elements. If you do not specify **window**, then **fir2** uses a Hamming window. For a list of available windows, see “Windows”.

fir2 does not automatically increase the length of **window** if you attempt to design a filter of odd order with a passband at the Nyquist frequency.

Example: `kaiser(n+1,0.5)` specifies a Kaiser window with shape parameter 0.5 to use with a filter of order n .

Example: `hamming(n+1)` is equivalent to leaving the window unspecified.

Data Types: `double`

Output Arguments

b — Filter coefficients

row vector

Filter coefficients, returned as a row vector of length $n + 1$. The coefficients are sorted in descending powers of the Z-transform variable z :

$$B(z) = b(1) + b(2)z + \dots + b(n+1)z^{-n}.$$

Algorithms

`fir2` uses frequency sampling to design filters. The function interpolates the desired frequency response linearly onto a dense, evenly spaced grid of length `npt`. `fir2` also sets up regions of `lap` points around repeated values of `f` to provide steep but smooth transitions. To obtain the filter coefficients, the function applies an inverse fast Fourier transform to the grid and multiplies by `window`.

References

- [1] Mitra, Sanjit K. *Digital Signal Processing: A Computer Based Approach*. New York: McGraw-Hill, 1998.
- [2] Jackson, L. B. *Digital Filters and Signal Processing*. 3rd Ed. Boston: Kluwer Academic Publishers, 1996.

Extended Capabilities

C/C++ Code Generation

Generate C and C++ code using MATLAB® Coder™.

Usage notes and limitations:

All inputs must be constants. Expressions or variables are allowed if their values do not change.

See Also

See Also

butter | cheby1 | cheby2 | designfilt | ellip | fir1 | firpm | hamming | maxflat | yulewalk

Introduced before R2006a

fircls

Constrained-least-squares FIR multiband filter design

Syntax

```
b = fircls(n,f,amp,up,lo)
fircls(n,f,amp,up,lo,'design_flag')
```

Description

`b = fircls(n,f,amp,up,lo)` generates a length $n+1$ linear phase FIR filter `b`. The frequency-magnitude characteristics of this filter match those given by vectors `f` and `amp`:

- `f` is a vector of transition frequencies in the range from 0 to 1, where 1 corresponds to the Nyquist frequency. The first point of `f` must be 0 and the last point 1. The frequency points must be in increasing order.
- `amp` is a vector describing the piecewise-constant desired amplitude of the frequency response. The length of `amp` is equal to the number of bands in the response and should be equal to `length(f) - 1`.
- `up` and `lo` are vectors with the same length as `amp`. They define the upper and lower bounds for the frequency response in each band.

`fircls` always uses an even filter order for configurations with a passband at the Nyquist frequency (that is, highpass and bandstop filters). This is because for odd orders, the frequency response at the Nyquist frequency is necessarily 0. If you specify an odd-valued `n`, `fircls` increments it by 1.

`fircls(n,f,amp,up,lo,'design_flag')` enables you to monitor the filter design, where `'design_flag'` can be

- `'trace'`, for a textual display of the design error at each iteration step.
- `'plots'`, for a collection of plots showing the filter's full-band magnitude response and a zoomed view of the magnitude response in each sub-band. All plots are updated

at each iteration step. The O's on the plot are the estimated extremals of the new iteration and the X's are the estimated extremals of the previous iteration, where the extremals are the peaks (maximum and minimum) of the filter ripples. Only ripples that have a corresponding O and X are made equal.

- 'both', for both the textual display and plots.

Note Normally, the lower value in the stopband will be specified as negative. By setting `lo` equal to 0 in the stopbands, a nonnegative frequency response amplitude can be obtained. Such filters can be spectrally factored to obtain minimum phase filters.

Examples

Constrained Least-Squares Lowpass Filter

Design a 150th-order lowpass filter with a normalized cutoff frequency of 0.4π rad/sample. Specify a maximum absolute error of 0.02 in the passband and 0.01 in the stopband. Display plots of the bands.

```
n = 150;
f = [0 0.4 1];
a = [1 0];
up = [1.02 0.01];
lo = [0.98 -0.01];
b = fircls(n,f,a,up,lo,'both');

Bound Violation = 0.0788344298966
Bound Violation = 0.0096137744998
Bound Violation = 0.0005681345753
Bound Violation = 0.0000051519942
Bound Violation = 0.0000000348656
Bound Violation = 0.0000000006231
```

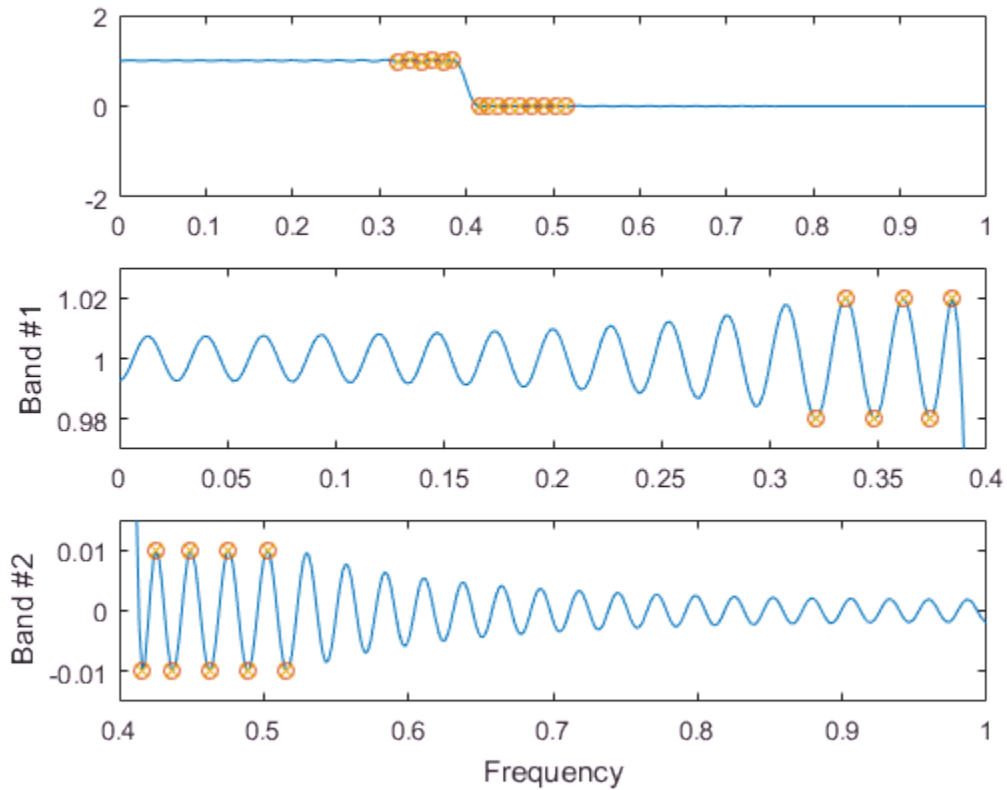

The Bound Violations denote the iterations of the procedure as the design converges. Display the magnitude response of the filter.

```
fvtool(b)
```

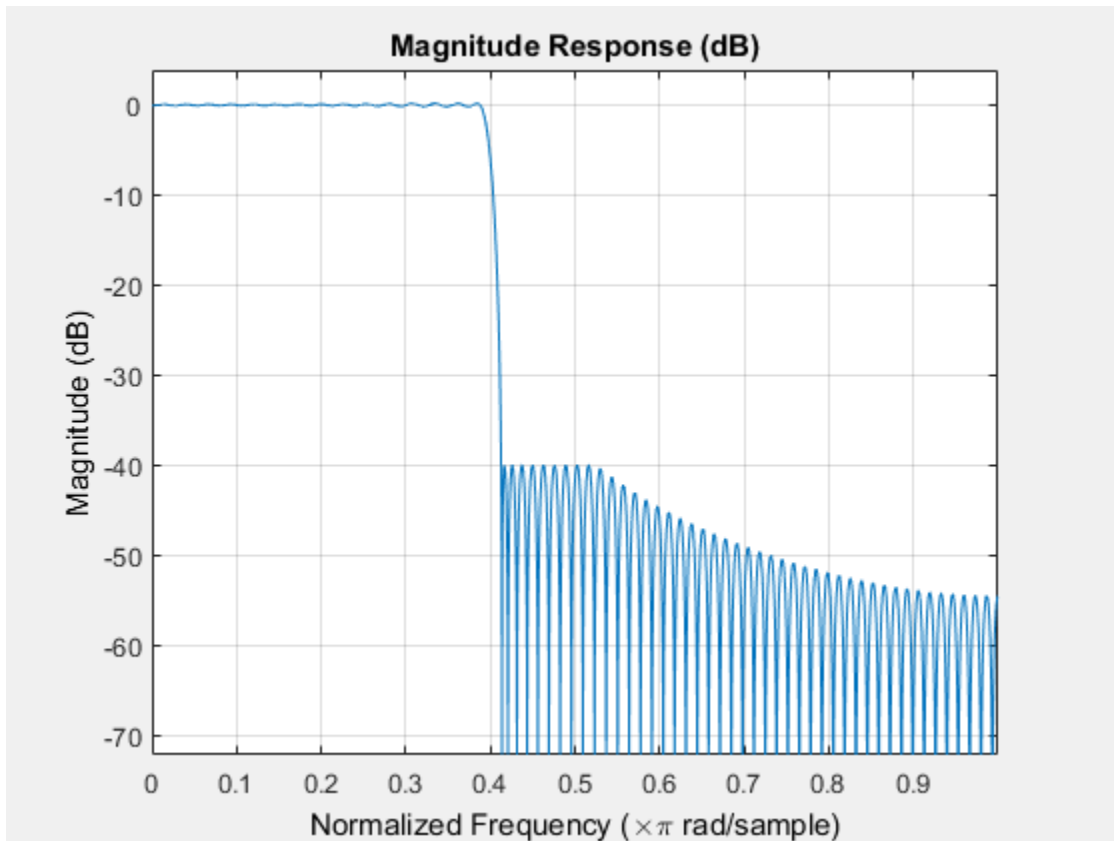

Algorithms

`fircls` uses an iterative least-squares algorithm to obtain an equiripple response. The algorithm is a multiple exchange algorithm that uses Lagrange multipliers and Kuhn-Tucker conditions on each iteration.

References

- [1] Selesnick, I. W., M. Lang, and C. S. Burrus. "Constrained Least Square Design of FIR Filters without Specified Transition Bands." *Proceedings of the 1995*

International Conference on Acoustics, Speech, and Signal Processing. Vol. 2, 1995, pp. 1260–1263.

- [2] Selesnick, I. W., M. Lang, and C. S. Burrus. “Constrained Least Square Design of FIR Filters without Specified Transition Bands.” *IEEE Transactions on Signal Processing*. Vol. 44, Number 8, 1996, pp. 1879–1892.

Extended Capabilities

C/C++ Code Generation

Generate C and C++ code using MATLAB® Coder™.

Usage notes and limitations:

All inputs must be constants. Expressions or variables are allowed if their values do not change.

See Also

`fircls1` | `firls` | `firpm`

Introduced before R2006a

fircls1

Constrained-least-squares linear-phase FIR lowpass and highpass filter design

Syntax

```
b = fircls1(n,wo,dp,ds)
b = fircls1(n,wo,dp,ds,'high')
b = fircls1(n,wo,dp,ds,wt)
b = fircls1(n,wo,dp,ds,wt,'high')
b = fircls1(n,wo,dp,ds,wp,ws,k)
b = fircls1(n,wo,dp,ds,wp,ws,k,'high')
b = fircls1(n,wo,dp,ds,...,'design_flag')
```

Description

`b = fircls1(n,wo,dp,ds)` generates a lowpass FIR filter `b`, where `n+1` is the filter length, `wo` is the normalized cutoff frequency in the range between 0 and 1 (where 1 corresponds to the Nyquist frequency), `dp` is the maximum passband deviation from 1 (passband ripple), and `ds` is the maximum stopband deviation from 0 (stopband ripple).

`b = fircls1(n,wo,dp,ds,'high')` generates a highpass FIR filter `b`. `fircls1` always uses an even filter order for the highpass configuration. This is because for odd orders, the frequency response at the Nyquist frequency is necessarily 0. If you specify an odd-valued `n`, `fircls1` increments it by 1.

`b = fircls1(n,wo,dp,ds,wt)` and

`b = fircls1(n,wo,dp,ds,wt,'high')` specifies a frequency `wt` above which (for `wt > wo`) or below which (for `wt < wo`) the filter is guaranteed to meet the given band criterion. This will help you design a filter that meets a passband or stopband edge requirement. There are four cases:

- Lowpass:
 - $0 < wt < wo < 1$: the amplitude of the filter is within `dp` of 1 over the frequency range $0 < \omega < wt$.

- $0 < \omega_0 < \omega_t < 1$: the amplitude of the filter is within δ_s of 0 over the frequency range $\omega_t < \omega < 1$.
- Highpass:
 - $0 < \omega_t < \omega_0 < 1$: the amplitude of the filter is within δ_s of 0 over the frequency range $0 < \omega < \omega_t$.
 - $0 < \omega_0 < \omega_t < 1$: the amplitude of the filter is within δ_p of 1 over the frequency range $\omega_t < \omega < 1$.

$\mathbf{b} = \text{fircls1}(n, \omega_0, \delta_p, \delta_s, \omega_p, \omega_s, k)$ generates a lowpass FIR filter \mathbf{b} with a weighted function, where $n+1$ is the filter length, ω_0 is the normalized cutoff frequency, δ_p is the maximum passband deviation from 1 (passband ripple), and δ_s is the maximum stopband deviation from 0 (stopband ripple). ω_p is the passband edge of the L2 weight function and ω_s is the stopband edge of the L2 weight function, where $\omega_p < \omega_0 < \omega_s$. k is the ratio (passband L2 error)/(stopband L2 error)

$$k = \frac{\int_0^{\omega_p} |A(\omega) - D(\omega)|^2 d\omega}{\int_{\omega_s}^{\pi} |A(\omega) - D(\omega)|^2 d\omega}$$

$\mathbf{b} = \text{fircls1}(n, \omega_0, \delta_p, \delta_s, \omega_p, \omega_s, k, \text{'high'})$ generates a highpass FIR filter \mathbf{b} with a weighted function, where $\omega_s < \omega_0 < \omega_p$.

$\mathbf{b} = \text{fircls1}(n, \omega_0, \delta_p, \delta_s, \dots, \text{'design_flag'})$ enables you to monitor the filter design, where *'design_flag'* can be

- *'trace'*, for a textual display of the design table used in the design
- *'plots'*, for plots of the filter's magnitude, group delay, and zeros and poles. All plots are updated at each iteration step. The O's on the plot are the estimated extremals of the new iteration and the X's are the estimated extremals of the previous iteration, where the extremals are the peaks (maximum and minimum) of the filter ripples. Only ripples that have a corresponding O and X are made equal.
- *'both'*, for both the textual display and plots

Note In the design of very narrow band filters with small δ_p and δ_s , there may not exist a filter of the given length that meets the specifications.

Examples

Filter Design with `fircls1`

Design an order 55 lowpass filter with normalized cutoff frequency 0.3. Specify a passband ripple of 0.02 and a stopband ripple of 0.008. Display plots of the bands.

```
n = 55;
wo = 0.3;
dp = 0.02;
ds = 0.008;
b = fircls1(n,wo,dp,ds, 'both');

Bound Violation = 0.0870385343920
Bound Violation = 0.0149343456540
Bound Violation = 0.0056513587932
Bound Violation = 0.0001056264205
Bound Violation = 0.0000967624352
Bound Violation = 0.0000000226538
Bound Violation = 0.0000000000038
```

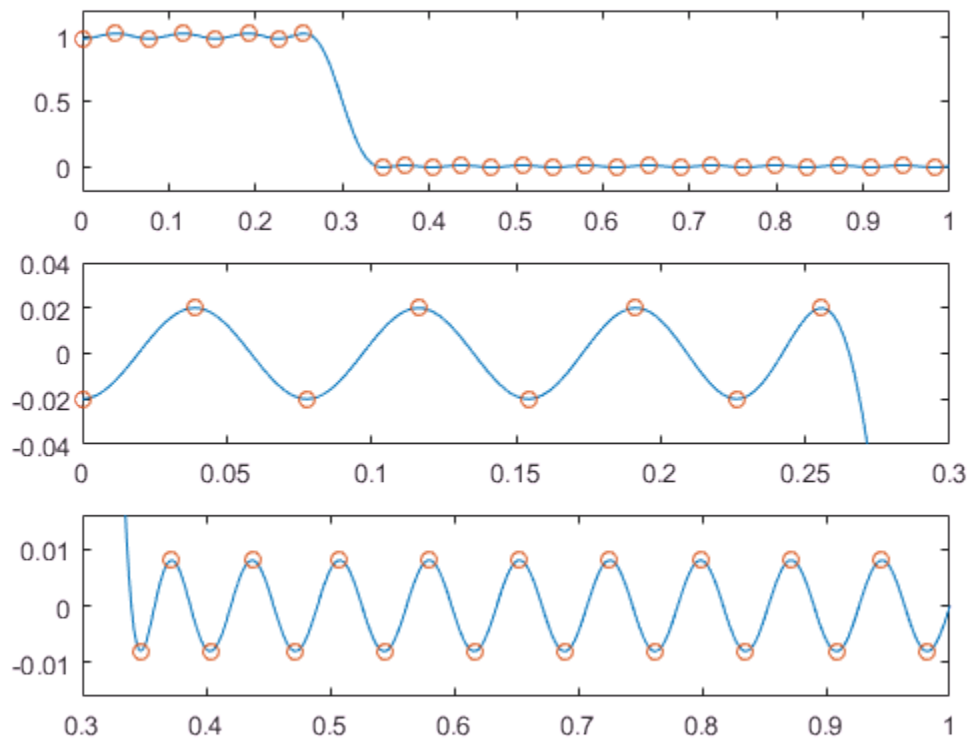

The Bound Violations denote the iterations of the procedure as the design converges. Display the magnitude response of the filter.

```
fvtool(b)
```

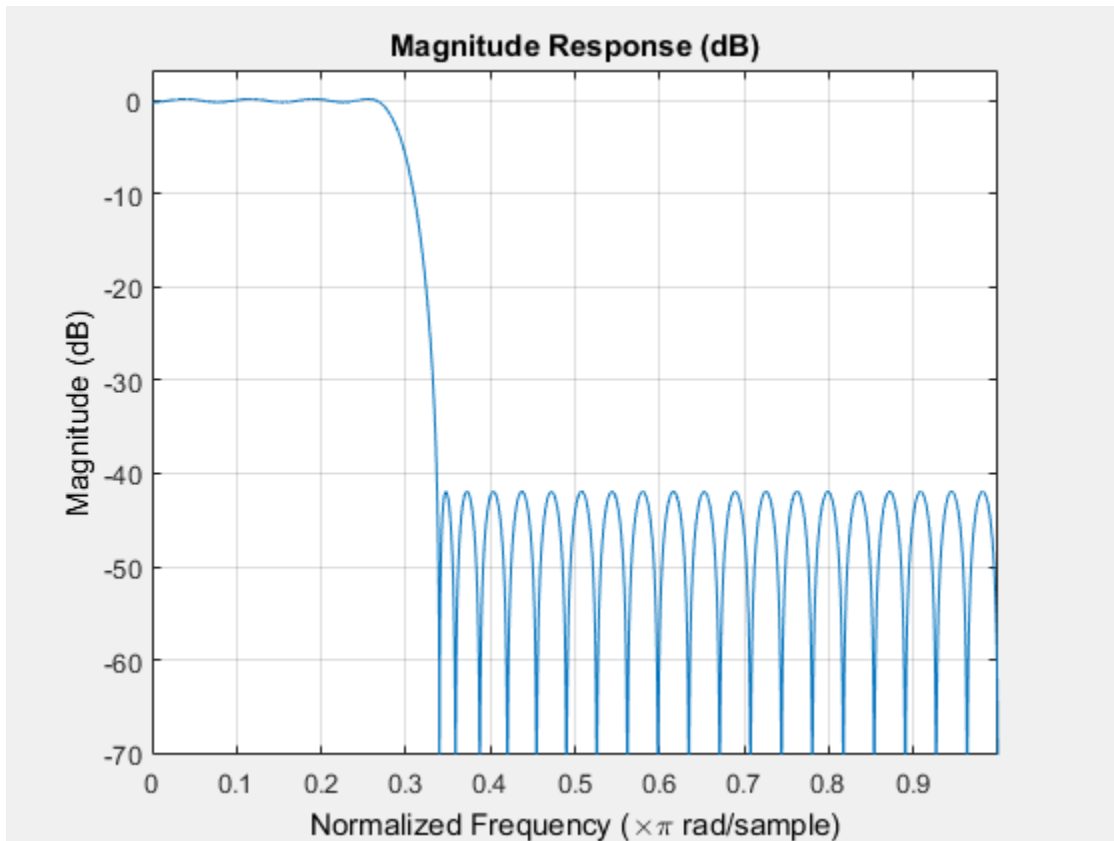

Algorithms

`fircls1` uses an iterative least-squares algorithm to obtain an equiripple response. The algorithm is a multiple exchange algorithm that uses Lagrange multipliers and Kuhn-Tucker conditions on each iteration.

References

- [1] Selesnick, I. W., M. Lang, and C. S. Burrus. "Constrained Least Square Design of FIR Filters without Specified Transition Bands." *Proceedings of the 1995*

International Conference on Acoustics, Speech, and Signal Processing. Vol. 2, 1995, pp. 1260–1263.

- [2] Selesnick, I. W., M. Lang, and C. S. Burrus. “Constrained Least Square Design of FIR Filters without Specified Transition Bands.” *IEEE Transactions on Signal Processing*. Vol. 44, Number 8, 1996, pp. 1879–1892.

Extended Capabilities

C/C++ Code Generation

Generate C and C++ code using MATLAB® Coder™.

Usage notes and limitations:

All inputs must be constants. Expressions or variables are allowed if their values do not change.

See Also

`fircls` | `firls` | `firpm`

Introduced before R2006a

firls

Least-squares linear-phase FIR filter design

Syntax

```
b = firls(n,f,a)
b = firls(n,f,a,w)
b = firls(n,f,a,'ftype')
b = firls(n,f,a,w,'ftype')
```

Description

`firls` designs a linear-phase FIR filter that minimizes the weighted, integrated squared error between an ideal piecewise linear function and the magnitude response of the filter over a set of desired frequency bands.

`b = firls(n,f,a)` returns row vector `b` containing the $n+1$ coefficients of the order n FIR filter whose frequency-amplitude characteristics approximately match those given by vectors `f` and `a`. The output filter coefficients, or “taps,” in `b` obey the symmetry relation.

$$b(k) = b(n+2-k), \quad k = 1, \dots, n+1$$

These are type I (n odd) and type II (n even) linear-phase filters. Vectors `f` and `a` specify the frequency-amplitude characteristics of the filter:

- `f` is a vector of pairs of frequency points, specified in the range between 0 and 1, where 1 corresponds to the Nyquist frequency. The frequencies must be in increasing order. Duplicate frequency points are allowed and, in fact, can be used to design a filter exactly the same as those returned by the `fir1` and `fir2` functions with a rectangular (`rectwin`) window.
- `a` is a vector containing the desired amplitude at the points specified in `f`.

The desired amplitude function at frequencies between pairs of points ($f(k)$, $f(k+1)$) for k odd is the line segment connecting the points ($f(k)$, $a(k)$) and ($f(k+1)$, $a(k+1)$).

The desired amplitude function at frequencies between pairs of points ($f(k)$, $f(k+1)$) for k even is unspecified. These are transition or “don’t care” regions.

- f and a are the same length. This length must be an even number.

`firls` always uses an even filter order for configurations with a passband at the Nyquist frequency. This is because for odd orders, the frequency response at the Nyquist frequency is necessarily 0. If you specify an odd-valued n , `firls` increments it by 1.

The figure below illustrates the relationship between the f and a vectors in defining a desired amplitude response.

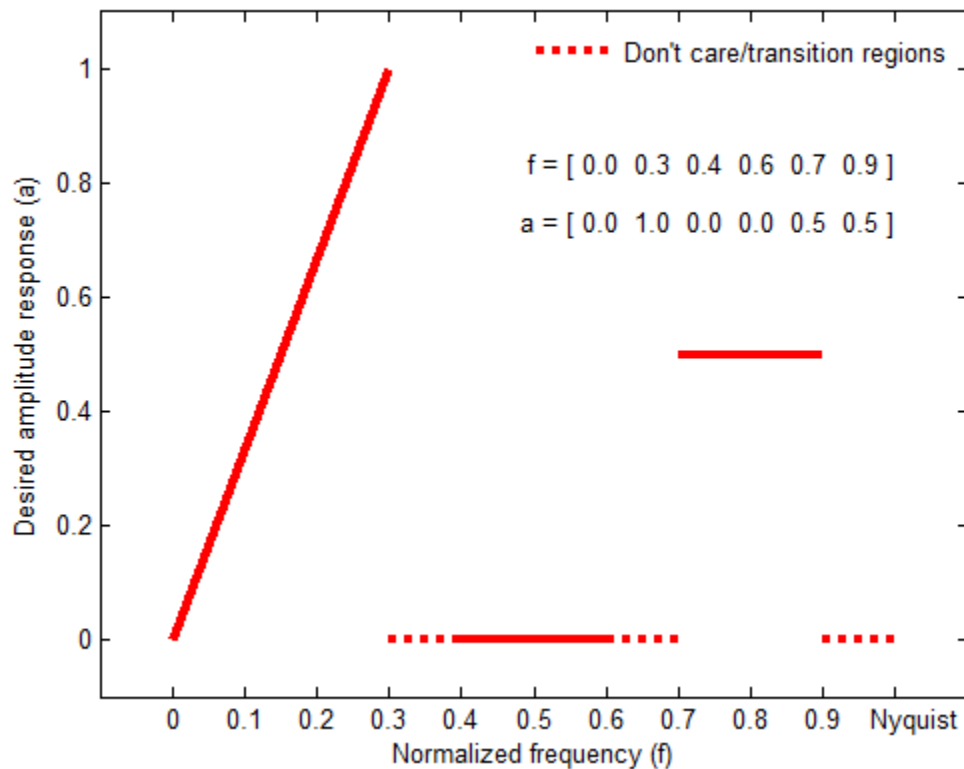

`b = firls(n,f,a,w)` uses the weights in vector `w` to weight the fit in each frequency band. The length of `w` is half the length of `f` and `a`, so there is exactly one weight per band.

`b = firls(n,f,a,'ftype')` and

`b = firls(n,f,a,w,'ftype')` specify a filter type, where `'ftype'` is:

- `'hilbert'` for linear-phase filters with odd symmetry (type III and type IV). The output coefficients in `b` obey the relation

$$b(k) = -b(n+2-k), \quad k = 1, \dots, n+1.$$

This class of filters includes the Hilbert transformer, which has a desired amplitude of 1 across the entire band.

- `'differentiator'` for type III and type IV filters, using a special weighting technique. For nonzero amplitude bands, the integrated squared error has a weight of $(1/f)^2$ so that the error at low frequencies is much smaller than at high frequencies. For FIR differentiators, which have an amplitude characteristic proportional to frequency, the filters minimize the relative integrated squared error (the integral of the square of the ratio of the error to the desired amplitude).

Examples

Filter with Transition Band

Design an FIR lowpass filter of order 255 with transition band between 0.25π and 0.3π . Use `fvtool` to display the magnitude and phase responses of the filter.

```
b = firls(255,[0 0.25 0.3 1],[1 1 0 0]);  
fvtool(b,1,'OverlaidAnalysis','phase')
```

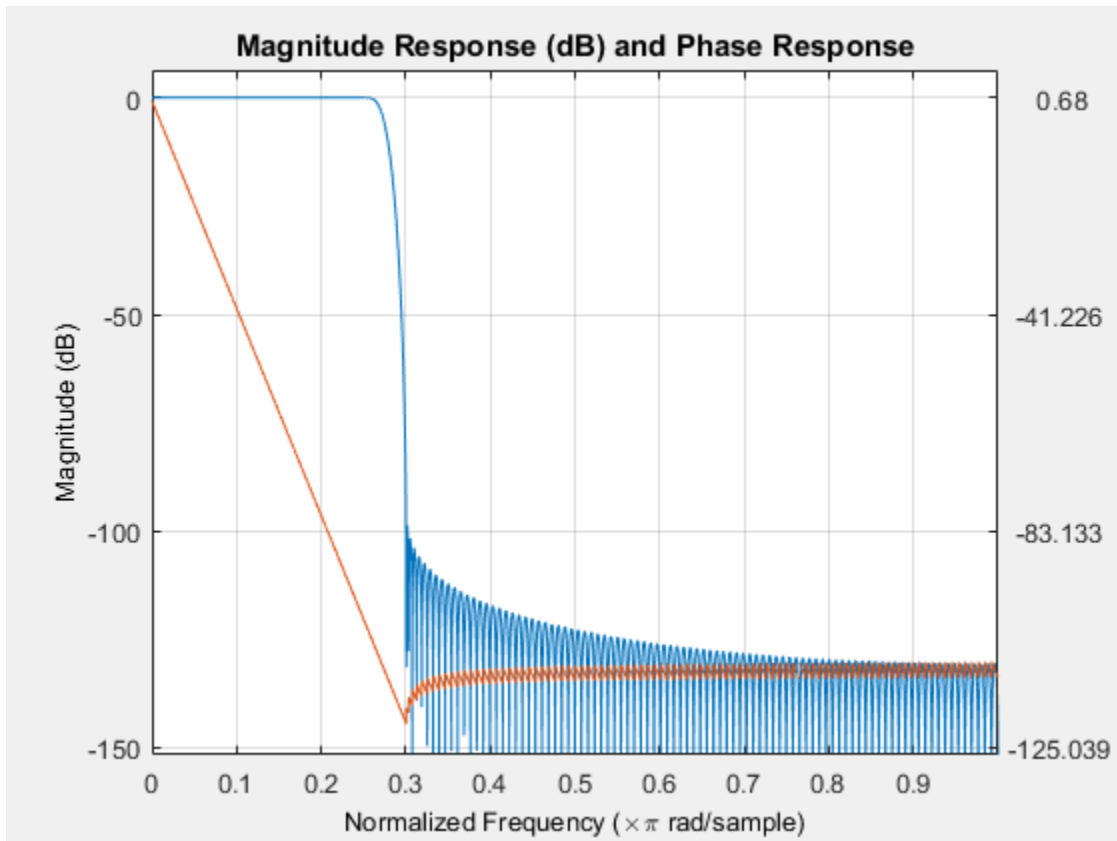
Design of a Differentiator

An ideal differentiator has a frequency response given by $D(\omega) = j\omega$. Design a differentiator of order 30 that attenuates frequencies above 0.9π . Include a factor of π in the amplitude because the frequencies are normalized by π . Display the zero-phase response of the filter.

```
b = firls(30,[0 0.9],[0 0.9*pi], 'differentiator');
fvtool(b,1, 'MagnitudeDisplay', 'zero-phase')
```

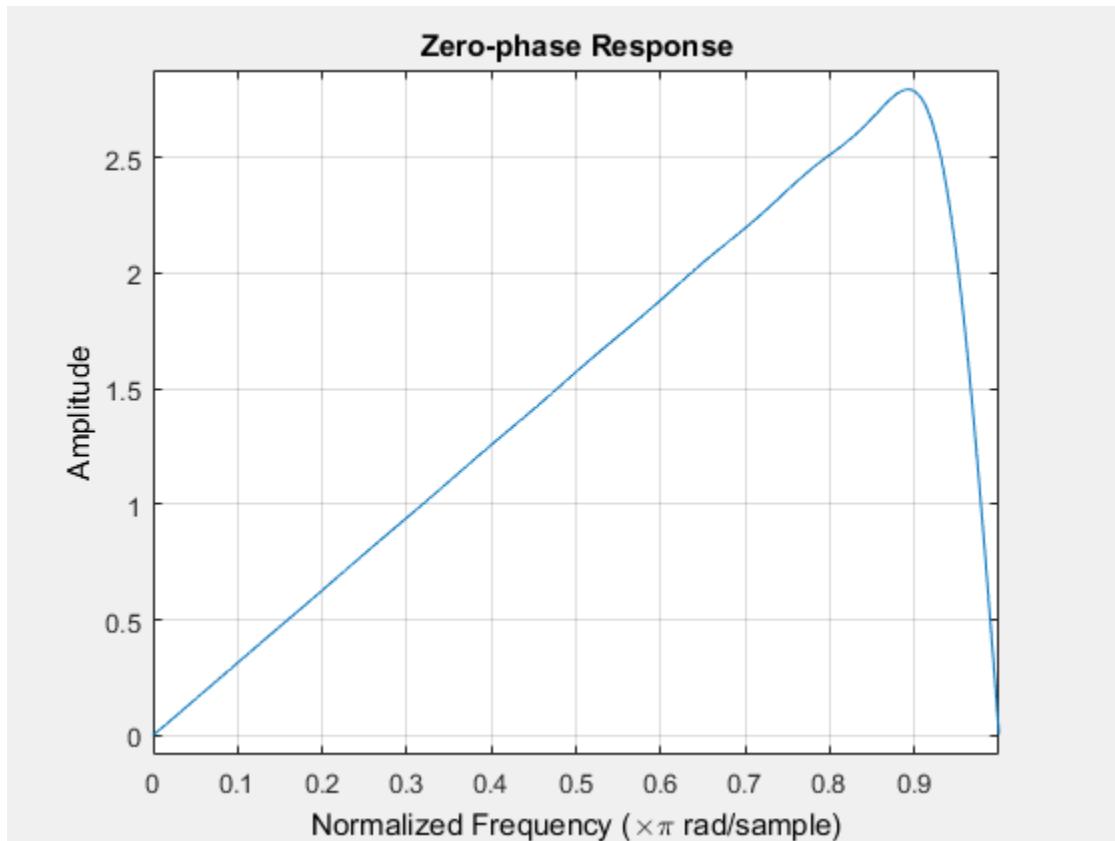

Filter with Piecewise Linear Passbands

Design a 24th-order antisymmetric filter with piecewise linear passbands.

```
F = [0 0.3 0.4 0.6 0.7 0.9];
A = [0 1.0 0.0 0.0 0.5 0.5];
b = firls(24,F,A,'hilbert');
```

Plot the desired and actual frequency responses.

```
[H,f] = freqz(b,1,512,2);
plot(f,abs(H))
hold on
for i = 1:2:6,
```

```

    plot([F(i) F(i+1)],[A(i) A(i+1)],'r--')
end
legend('firls design','Ideal')
grid on
xlabel('Normalized Frequency (\times\pi rad/sample)')
ylabel('Magnitude')

```

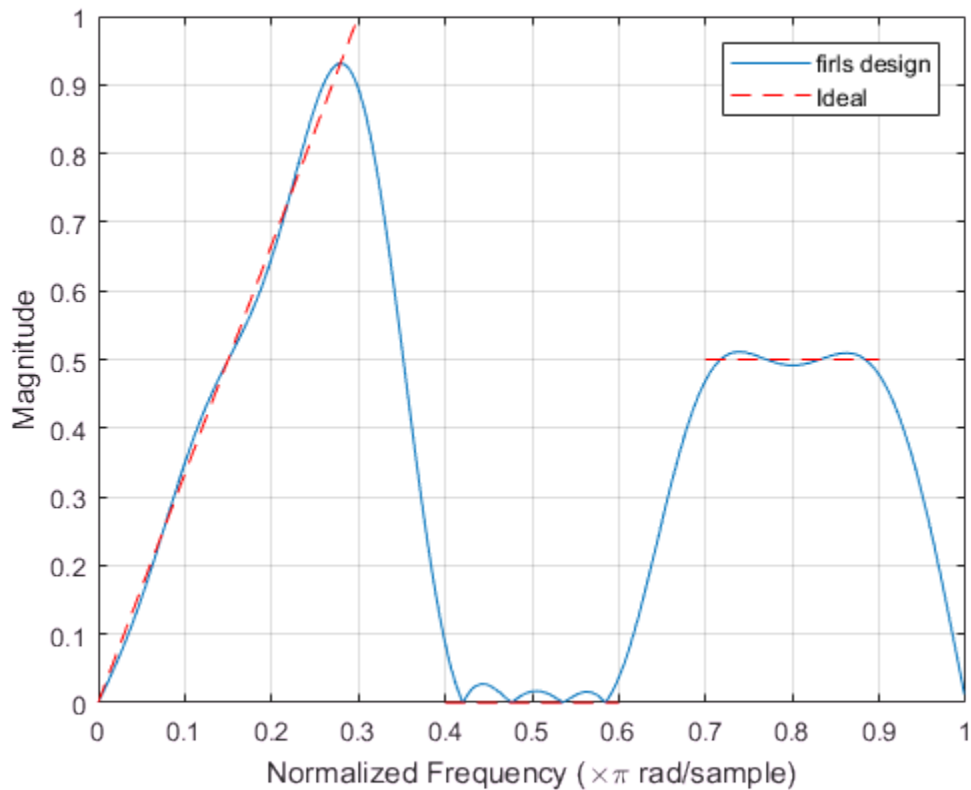

Lowpass Filter Design with Weighted Fit

Design an FIR lowpass filter. The passband ranges from DC to 0.45π rad/sample.

The stopband ranges from 0.55π rad/sample to the Nyquist frequency. Produce three different designs, changing the weights of the bands in the least-squares fit.

In the first design, make the stopband weight higher than the passband weight by a factor of 100. Use this specification when it is critical that the magnitude response in the stopband is flat and close to 0. The passband ripple is about 100 times higher than the stopband ripple.

```
bhi = firls(18,[0 0.45 0.55 1],[1 1 0 0],[1 100]);
```

In the second design, reverse the weights so that the passband weight is 100 times the stopband weight. Use this specification when it is critical that the magnitude response in the passband is flat and close to 1. The stopband ripple is about 100 times higher than the passband ripple.

```
blo = firls(18,[0 0.45 0.55 1],[1 1 0 0],[100 1]);
```

In the third design, give the same weight to both bands. The result is a filter with similar ripple in the passband and the stopband.

```
b = firls(18,[0 0.45 0.55 1],[1 1 0 0],[1 1]);
```

Visualize the magnitude responses of the three filters.

```
hfvt = fvtool(bhi,1,blo,1,b,1,'MagnitudeDisplay','Zero-phase');  
legend(hfvt,'bhi: w = [1 100]','blo: w = [100 1]','b: w = [1 1]')
```

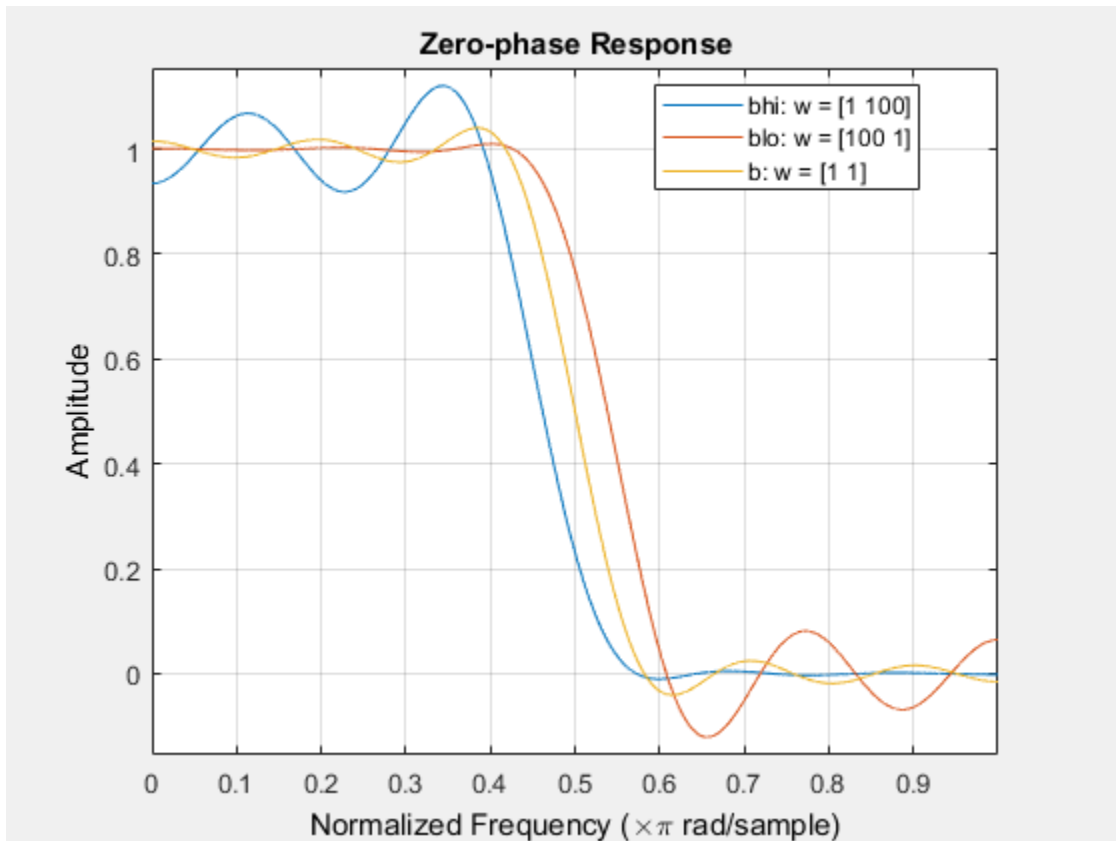

Diagnostics

One of the following diagnostic messages is displayed when an incorrect argument is used:

F must be even length.

F and A must be equal lengths.

Requires symmetry to be 'hilbert' or 'differentiator'.

Requires one weight per band.

Frequencies in F must be nondecreasing.

Frequencies in F must be in range [0,1].

A more serious warning message is

Warning: Matrix is close to singular or badly scaled.

This tends to happen when the product of the filter length and transition width grows large. In this case, the filter coefficients `b` might not represent the desired filter. You can check the filter by looking at its frequency response.

Algorithms

Reference [1] describes the theoretical approach behind `firls`. The function solves a system of linear equations involving an inner product matrix of size roughly $n/2$ using the MATLAB `\` operator.

This function designs type I, II, III, and IV linear-phase filters. Type I and II are the defaults for n even and odd respectively, while the `'hilbert'` and `'differentiator'` flags produce type III (n even) and IV (n odd) filters. The various filter types have different symmetries and constraints on their frequency responses (see [2] for details).

Linear Phase Filter Type	Filter Order	Symmetry of Coefficients	Response $H(f)$, $f = 0$	Response $H(f)$, $f = 1$ (Nyquist)
Type I	Even	$b(k) = b(n + 2 - k)$, $k = 1, \dots, n + 1$	No restriction	No restriction
Type II	Even	$b(k) = b(n + 2 - k)$, $k = 1, \dots, n + 1$	No restriction	$H(1) = 0$
Type III	Odd	$b(k) = -b(n + 2 - k)$, $k = 1, \dots, n + 1$	$H(0) = 0$	$H(1) = 0$
Type IV	Odd	$b(k) = -b(n + 2 - k)$, $k = 1, \dots, n + 1$	$H(0) = 0$	No restriction

References

- [1] Parks, Thomas W., and C. Sidney Burrus. *Digital Filter Design*. New York: John Wiley & Sons, 1987, pp. 54–83.
- [2] Oppenheim, Alan V., Ronald W. Schaffer, and John R. Buck. *Discrete-Time Signal Processing*. Upper Saddle River, NJ: Prentice Hall, 1999.

Extended Capabilities

C/C++ Code Generation

Generate C and C++ code using MATLAB® Coder™.

Usage notes and limitations:

All inputs must be constants. Expressions or variables are allowed if their values do not change.

See Also

`fir1` | `fir2` | `firpm` | `rcosdesign`

Introduced before R2006a

firpm

Parks-McClellan optimal FIR filter design

Syntax

```
b = firpm(n,f,a)
b = firpm(n,f,a,w)
b = firpm(n,f,a,'ftype')
b = firpm(n,f,a,w,'ftype')
b = firpm(...,{lgrid})
[b,err] = firpm(...)
[b,err,res] = firpm(...)
b = firpm(n,f,@fresp,w)
b = firpm(n,f,@fresp,w,'ftype')
```

Description

`firpm` designs a linear-phase FIR filter using the Parks-McClellan algorithm [1]. The Parks-McClellan algorithm uses the Remez exchange algorithm and Chebyshev approximation theory to design filters with an optimal fit between the desired and actual frequency responses. The filters are optimal in the sense that the maximum error between the desired frequency response and the actual frequency response is minimized. Filters designed this way exhibit an equiripple behavior in their frequency responses and are sometimes called *equiripple* filters. `firpm` exhibits discontinuities at the head and tail of its impulse response due to this equiripple nature.

`b = firpm(n,f,a)` returns row vector `b` containing the $n+1$ coefficients of the order n FIR filter whose frequency-amplitude characteristics match those given by vectors `f` and `a`.

The output filter coefficients (taps) in `b` obey the symmetry relation:

$$b(k) = b(n+2-k), \quad k = 1, \dots, n+1$$

Vectors `f` and `a` specify the frequency-magnitude characteristics of the filter:

- \mathbf{f} is a vector of pairs of normalized frequency points, specified in the range between 0 and 1, where 1 corresponds to the Nyquist frequency. The frequencies must be in increasing order.
- \mathbf{a} is a vector containing the desired amplitudes at the points specified in \mathbf{f} .

The desired amplitude at frequencies between pairs of points $(f(k), f(k+1))$ for k odd is the line segment connecting the points $(f(k), a(k))$ and $(f(k+1), a(k+1))$.

The desired amplitude at frequencies between pairs of points $(f(k), f(k+1))$ for k even is unspecified. The areas between such points are transition or “don't care” regions.

- \mathbf{f} and \mathbf{a} must be the same length. The length must be an even number.

The relationship between the \mathbf{f} and \mathbf{a} vectors in defining a desired frequency response is shown in the illustration below.

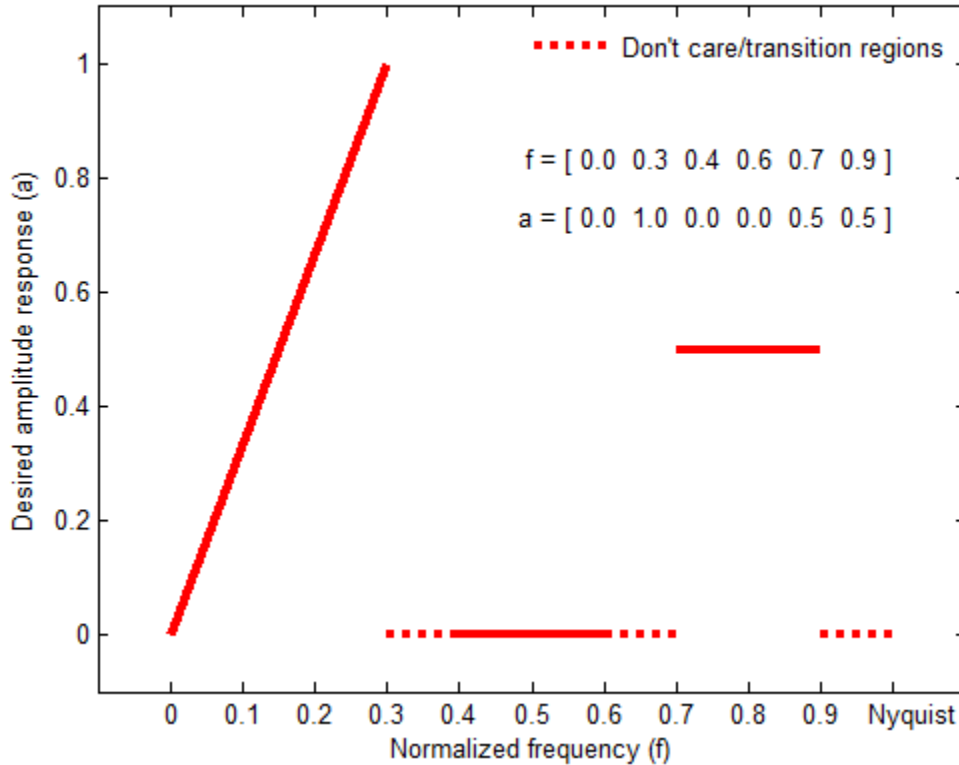

`firpm` always uses an even filter order for configurations with even symmetry and a nonzero passband at the Nyquist frequency. This is because for impulse responses exhibiting even symmetry and odd orders, the frequency response at the Nyquist frequency is necessarily 0. If you specify an odd-valued `n`, `firpm` increments it by 1.

`b = firpm(n,f,a,w)` uses the weights in vector `w` to weight the fit in each frequency band. The length of `w` is half the length of `f` and `a`, so there is exactly one weight per band.

Note `b = firpm(n,f,a,w)` is a synonym for `b = firpm(n,f,{@firpmfrf,a},w)`, where, `@firpmfrf` is the predefined frequency response function handle for `firpm`. If

desired, you can write your own response function. Use `help private/firpmfrf` and see “Create Function Handle” (MATLAB) for more information.

`b = firpm(n,f,a,'ftype')` and

`b = firpm(n,f,a,w,'ftype')` specify a filter type, where `'ftype'` is

- `'hilbert'`, for linear-phase filters with odd symmetry (type III and type IV)

The output coefficients in `b` obey the relation $b(k) = -b(n + 2 - k)$, $k = 1, \dots, n + 1$. This class of filters includes the Hilbert transformer, which has a desired amplitude of 1 across the entire band.

For example,

```
h = firpm(30,[0.1 0.9],[1 1],'hilbert');
```

designs an approximate FIR Hilbert transformer of length 31.

- `'differentiator'`, for type III and type IV filters, using a special weighting technique

For nonzero amplitude bands, it weights the error by a factor of $1/f$ so that the error at low frequencies is much smaller than at high frequencies. For FIR differentiators, which have an amplitude characteristic proportional to frequency, these filters minimize the maximum relative error (the maximum of the ratio of the error to the desired amplitude).

`b = firpm(...,{lgrid})` uses the integer `lgrid` to control the density of the frequency grid, which has roughly $(lgrid*n)/(2*bw)$ frequency points, where `bw` is the fraction of the total frequency band interval $[0,1]$ covered by `f`. Increasing `lgrid` often results in filters that more exactly match an equiripple filter, but that take longer to compute. The default value of 16 is the minimum value that should be specified for `lgrid`. Note that the `{lgrid}` argument must be a 1-by-1 cell array.

`[b,err] = firpm(...)` returns the maximum ripple height in `err`.

`[b,err,res] = firpm(...)` returns a structure `res` with the following fields.

<code>res.fgrid</code>	Frequency grid vector used for the filter design optimization
<code>res.des</code>	Desired frequency response for each point in <code>res.fgrid</code>

<code>res.wt</code>	Weighting for each point in <code>opt.fgrid</code>
<code>res.H</code>	Actual frequency response for each point in <code>res.fgrid</code>
<code>res.error</code>	Error at each point in <code>res.fgrid</code> (<code>res.des-res.H</code>)
<code>res.iextr</code>	Vector of indices into <code>res.fgrid</code> for extremal frequencies
<code>res.fextr</code>	Vector of extremal frequencies

You can also use `firpm` to write a function that defines the desired frequency response. The predefined frequency response function handle for `firpm` is `@firpmfrf`, which designs a linear-phase FIR filter.

`b = firpm(n,f,@fresp,w)` returns row vector `b` containing the `n+1` coefficients of the order `n` FIR filter whose frequency-amplitude characteristics best approximate the response returned by function handle `@fresp`. The function is called from within `firpm` with the following syntax.

```
[dh,dw] = fresp(n,f,gf,w)
```

The arguments are similar to those for `firpm`:

- `n` is the filter order.
- `f` is the vector of normalized frequency band edges that appear monotonically between 0 and 1, where 1 is the Nyquist frequency.
- `gf` is a vector of grid points that have been linearly interpolated over each specified frequency band by `firpm`. `gf` determines the frequency grid at which the response function must be evaluated, and contains the same data returned by `cfirpm` in the `fgrid` field of the `opt` structure.
- `w` is a vector of real, positive weights, one per band, used during optimization. `w` is optional in the call to `firpm`; if not specified, it is set to unity weighting before being passed to `fresp`.
- `dh` and `dw` are the desired complex frequency response and band weight vectors, respectively, evaluated at each frequency in grid `gf`.

`b = firpm(n,f,@fresp,w,'ftype')` designs antisymmetric (odd) filters, where `'ftype'` is either `'d'` for a differentiator or `'h'` for a Hilbert transformer. If you do not specify an `ftype`, a call is made to `fresp` to determine the default symmetry property `sym`. This call is made using the syntax.

```
sym = fresp('defaults',{n,f,[],w,p1,p2,...})
```

The arguments `n`, `f`, `w`, etc., may be used as necessary in determining an appropriate value for `sym`, which `firpm` expects to be either 'even' or 'odd'. If `fresp` does not support this calling syntax, `firpm` defaults to even symmetry.

Examples

Parks-McClellan Bandpass Filter

Use the Parks-McClellan algorithm to design an FIR bandpass filter of order 17.

Specify normalized stopband frequencies of 0.3π and 0.7π rad/sample and normalized passband frequencies of 0.4π and 0.6π rad/sample. Plot the ideal and actual magnitude responses.

```
f = [0 0.3 0.4 0.6 0.7 1];
a = [0 0.0 1.0 1.0 0.0 0];
b = firpm(17,f,a);

[h,w] = freqz(b,1,512);
plot(f,a,w/pi,abs(h))
legend('Ideal','firpm Design')
xlabel 'Radian Frequency (\omega/\pi)', ylabel 'Magnitude'
```

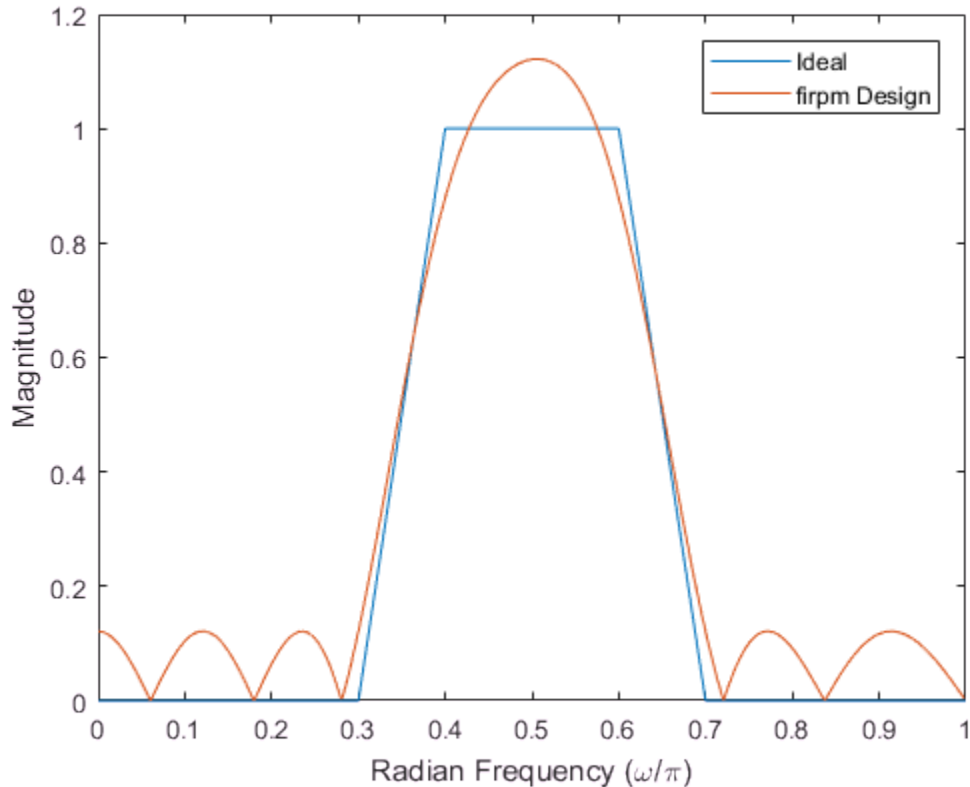

FIR Bandpass Filter with Asymmetric Attenuation

Use the Parks-McClellan algorithm to create a 50th-order equiripple FIR bandpass filter to be used with signals sampled at 1 kHz.

```
N = 50;  
Fs = 1e3;
```

Specify that the passband spans the frequencies between 200 Hz and 300 Hz and that the transition region on either side of the passband has a width of 50 Hz.

```
Fstop1 = 150;  
Fpass1 = 200;  
Fpass2 = 300;
```

```
Fstop2 = 350;
```

Design the filter so that the optimization fit weights the low-frequency stopband with a weight of 3, the passband with a weight of 1, and the high-frequency stopband with a weight of 100. Display the magnitude response of the filter.

```
Wstop1 = 3;
```

```
Wpass = 1;
```

```
Wstop2 = 100;
```

```
b = firpm(N,[0 Fstop1 Fpass1 Fpass2 Fstop2 Fs/2]/(Fs/2), ...  
          [0 0 1 1 0 0],[Wstop1 Wpass Wstop2]);
```

```
fvtool(b,1)
```

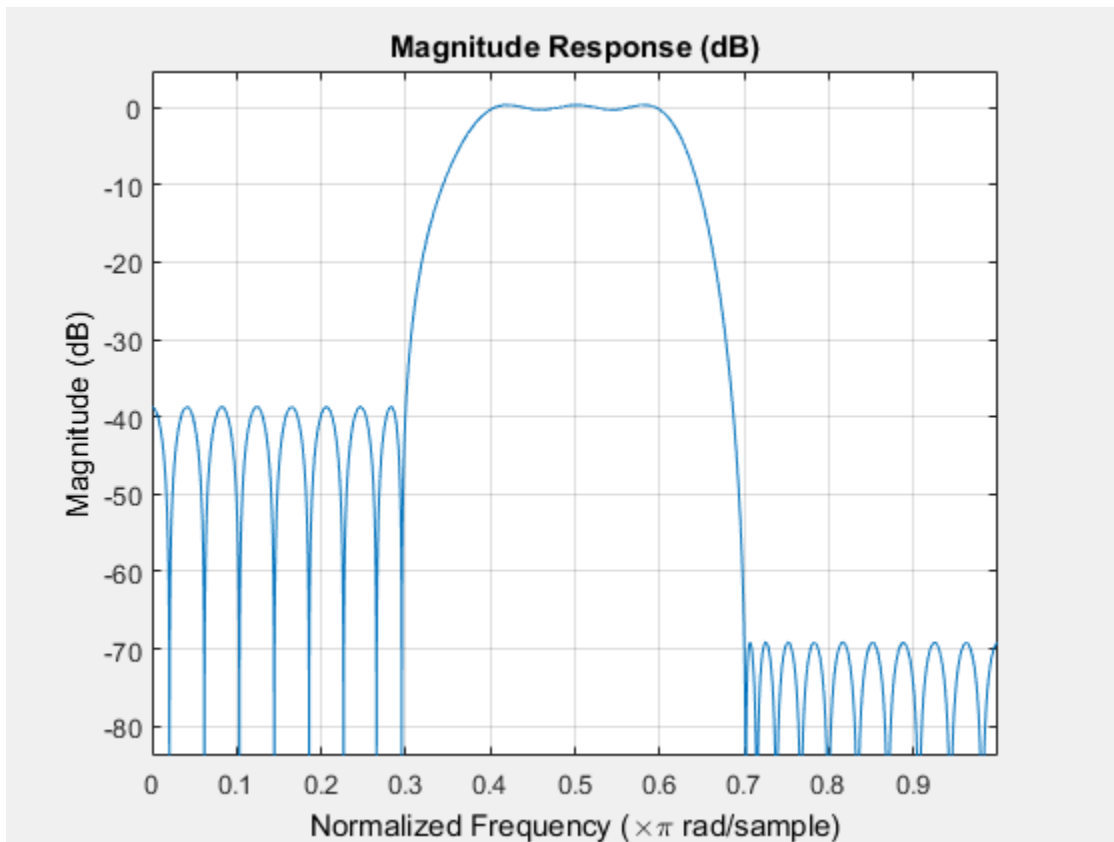

Tips

If your filter design fails to converge, it is possible that the filter design is correct. Verify the design by checking the frequency response.

If your filter design fails to converge and the resulting filter design is not correct, attempt one or more of the following:

- Increase the filter order
- Relax the filter design by reducing the attenuation in the stopbands and/or broadening the transition regions

Algorithms

`firpm` designs type I, II, III, and IV linear-phase filters. Type I and type II are the defaults for n even and n odd, respectively, while type III (n even) and type IV (n odd) are obtained with the `'hilbert'` and `'differentiator'` flags. The different types of filters have different symmetries and certain constraints on their frequency responses (see [5] for more details).

Linear Phase Filter Type	Filter Order	Symmetry of Coefficients	Response $H(f), f = 0$	Response $H(f), f = 1$ (Nyquist)
Type I	Even	even: $b(k) = b(n + 2 - k), \quad k = 1, \dots, n + 1$	No restriction	No restriction
Type II	Odd	even: $b(k) = b(n + 2 - k), \quad k = 1, \dots, n + 1$	No restriction	$H(1)=0$ <code>firpm</code> increments the filter order by 1 if you attempt to construct a type II filter with a nonzero passband at the Nyquist frequency.

Linear Phase Filter Type	Filter Order	Symmetry of Coefficients	Response $H(f)$, $f = 0$	Response $H(f)$, $f = 1$ (Nyquist)
Type III	Even	odd: $b(k) = -b(n + 2 - k), \quad k = 1, \dots, n + 1$	$H(0) = 0$	$H(1) = 0$
Type IV	Odd	odd: $b(k) = -b(n + 2 - k), \quad k = 1, \dots, n + 1$	$H(0) = 0$	No restriction

References

- [1] Digital Signal Processing Committee of the IEEE Acoustics, Speech, and Signal Processing Society, eds. *Programs for Digital Signal Processing*. New York: IEEE Press, 1979, algorithm5.1.
- [2] Digital Signal Processing Committee of the IEEE Acoustics, Speech, and Signal Processing Society, eds. *Selected Papers in Digital Signal Processing*. Vol. II. New York: IEEE Press, 1976.
- [3] Parks, Thomas W., and C. Sidney Burrus. *Digital Filter Design*. New York: John Wiley & Sons, 1987, p.83.
- [4] Rabiner, Lawrence R., James H. McClellan, and Thomas W. Parks. "FIR Digital Filter Design Techniques Using Weighted Chebyshev Approximation." *Proceedings of the IEEE*. Vol.63, Number4, 1975, pp.595–610.
- [5] Oppenheim, Alan V., Ronald W. Schaffer, and John R. Buck. *Discrete-Time Signal Processing*. Upper Saddle River, NJ: Prentice Hall, 1999, p.486.

Extended Capabilities

C/C++ Code Generation

Generate C and C++ code using MATLAB® Coder™.

Usage notes and limitations:

All inputs must be constants. Expressions or variables are allowed if their values do not change.

See Also

butter | cheby1 | cheby2 | cfirpm | ellip | fir1 | fir2 | fircls | fircls1 | firls | | firpmord | rcosdesign | yulewalk

Introduced before R2006a

firpmord

Parks-McClellan optimal FIR filter order estimation

Syntax

```
[n,fo,ao,w] = firpmord(f,a,dev)
[n,fo,ao,w] = firpmord(f,a,dev,fs)
c = firpmord(f,a,dev,fs,'cell')
```

Description

`[n,fo,ao,w] = firpmord(f,a,dev)` finds the approximate order, normalized frequency band edges, frequency band amplitudes, and weights that meet input specifications `f`, `a`, and `dev`.

- `f` is a vector of frequency band edges (between 0 and $F_s/2$, where F_s is the sampling frequency), and `a` is a vector specifying the desired amplitude on the bands defined by `f`. The length of `f` is two less than twice the length of `a`. The desired function is piecewise constant.
- `dev` is a vector the same size as `a` that specifies the maximum allowable deviation or ripples between the frequency response and the desired amplitude of the output filter for each band.

Use `firpm` with the resulting order `n`, frequency vector `fo`, amplitude response vector `ao`, and weights `w` to design the filter `b` which approximately meets the specifications given by `firpmord` input parameters `f`, `a`, and `dev`.

```
b = firpm(n,fo,ao,w)
```

`[n,fo,ao,w] = firpmord(f,a,dev,fs)` specifies a sampling frequency `fs`. `fs` defaults to 2 Hz, implying a Nyquist frequency of 1 Hz. You can therefore specify band edges scaled to a particular application's sampling frequency.

`c = firpmord(f,a,dev,fs,'cell')` generates a cell-array whose elements are the parameters to `firpm`.

Note In some cases, `firpmord` underestimates or overestimates the order n . If the filter does not meet the specifications, try a higher order such as $n+1$ or $n+2$.

Examples

Minimum-Order Lowpass Filter

Design a minimum-order lowpass filter with a 500 Hz passband cutoff frequency and 600 Hz stopband cutoff frequency. Specify a sampling frequency of 2000 Hz. Require at least 40 dB of attenuation in the stopband and less than 3 dB of ripple in the passband.

```
rp = 3;           % Passband ripple
rs = 40;          % Stopband ripple
fs = 2000;        % Sampling frequency
f = [500 600];    % Cutoff frequencies
a = [1 0];        % Desired amplitudes
```

Convert the deviations to linear units. Design the filter and visualize its magnitude and phase responses.

```
dev = [(10^(rp/20)-1)/(10^(rp/20)+1) 10^(-rs/20)];
[n,fo,ao,w] = firpmord(f,a,dev,fs);
b = firpm(n,fo,ao,w);
freqz(b,1,1024,fs)
title('Lowpass Filter Designed to Specifications')
```

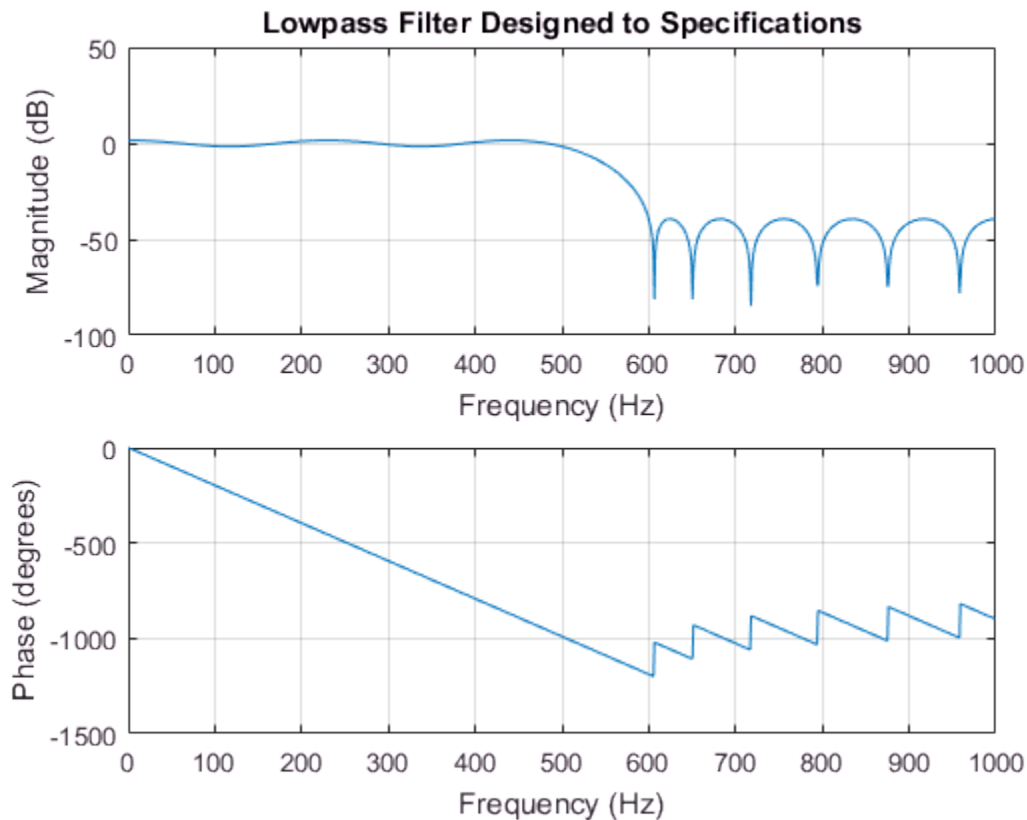

Note that the filter falls slightly short of meeting the stopband attenuation and passband ripple specifications. Using `n+1` in the call to `firmsord` instead of `n` achieves the desired amplitude characteristics.

Parks-McClellan Order of Lowpass Filter

Design a lowpass filter with a 1500 Hz passband cutoff frequency and 2000 Hz stopband cutoff frequency. Specify a sampling frequency of 8000 Hz. Require a maximum stopband amplitude of 0.1 and a maximum passband error (ripple) of 0.01.

```
[n,fo,ao,w] = firmsord([1500 2000],[1 0],[0.01 0.1],8000);
b = firmsord(n,fo,ao,w);
```

Obtain an equivalent result by having `firpmord` generate a cell array. Visualize the frequency response of the filter.

```
c = firpmord([1500 2000],[1 0],[0.01 0.1],8000,'cell');  
B = firpm(c{:});  
freqz(B,1,1024,8000)
```

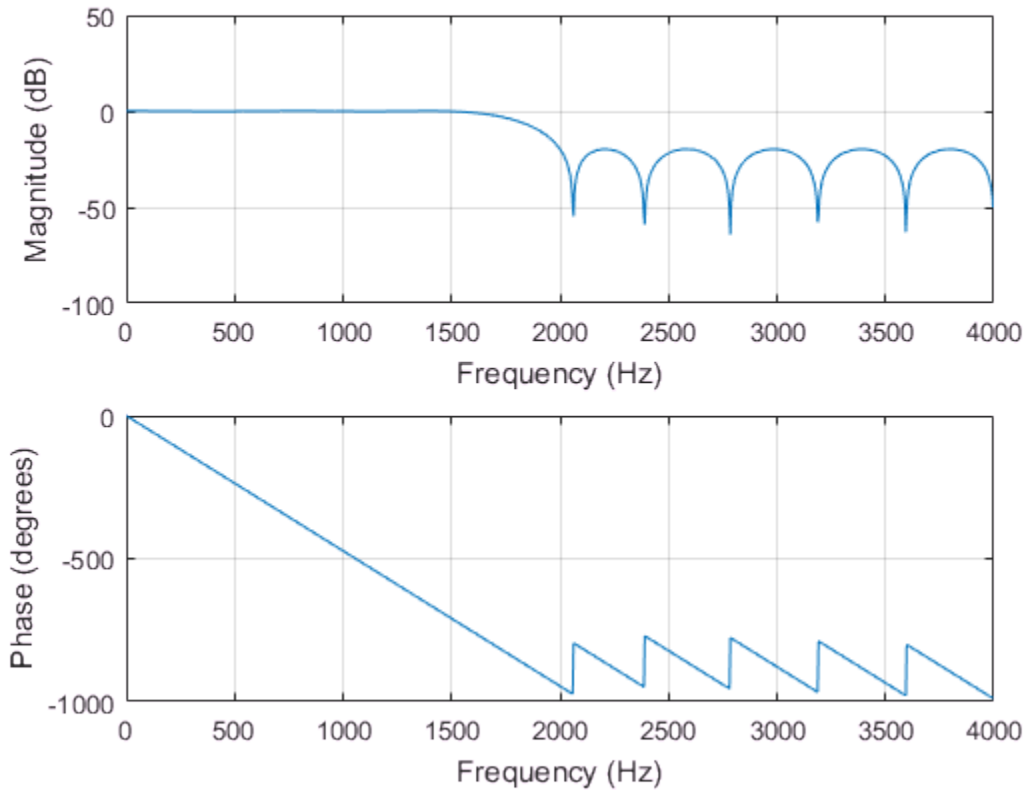

Algorithms

`firpmord` uses the algorithm suggested in [1]. This method is inaccurate for band edges close to either 0 or the Nyquist frequency, $f_s/2$.

References

- [1] Rabiner, Lawrence R., and Otto Herrmann. “The Predictability of Certain Optimum Finite-Impulse-Response Digital Filters.” *IEEE Transactions on Circuit Theory*. Vol. 20, Number4, 1973, pp.401–408.
- [2] Rabiner, Lawrence R., and Bernard Gold. *Theory and Application of Digital Signal Processing*. Englewood Cliffs, NJ: Prentice-Hall, 1975, pp.156–157.

Extended Capabilities

C/C++ Code Generation

Generate C and C++ code using MATLAB® Coder™.

Usage notes and limitations:

All inputs must be constants. Expressions or variables are allowed if their values do not change.

See Also

`buttord` | `cheb1ord` | `cheb2ord` | `ellipord` | `kaiserord` | `firpm`

Introduced before R2006a

firtype

Type of linear phase FIR filter

Syntax

```
t = firtype(b)
t = firtype(d)
```

Description

`t = firtype(b)` determines the type, `t`, of an FIR filter with coefficients `b`. `t` can be 1, 2, 3, or 4. The filter must be real and have linear phase.

`t = firtype(d)` determines the type, `t`, of an FIR filter, `d`. `t` can be 1, 2, 3, or 4. The filter must be real and have linear phase.

Examples

Types of Linear Phase Filters

Design two FIR filters using the window method, one of even order and the other of odd order. Determine their types and plot their impulse responses.

```
subplot(2,1,1)
b = fir1(8,0.5);
impz(b), title(['Type ' int2str(firtype(b))])
```

```
subplot(2,1,2)
b = fir1(9,0.5);
impz(b), title(['Type ' int2str(firtype(b))])
```

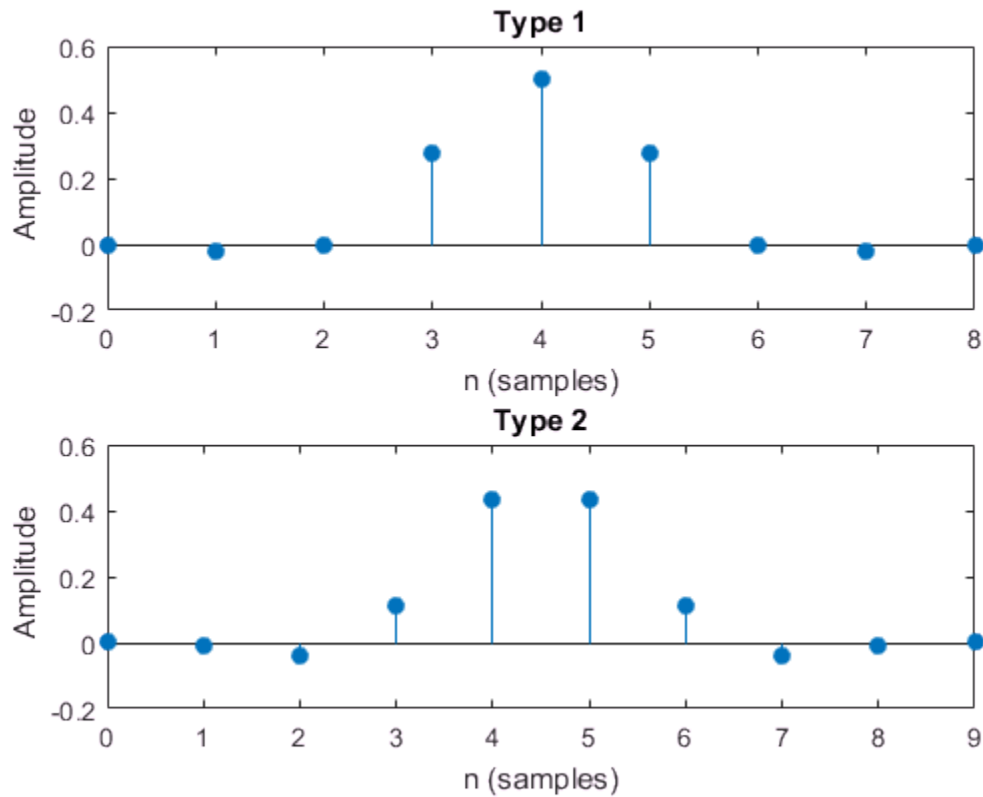
Design two equiripple Hilbert transformers, one of even order and the other of odd order. Determine their types and plot their impulse responses.

```
subplot(2,1,1)
b = firpm(8,[0.2 0.8],[1 1], 'hilbert');
impz(b), title(['Type ' int2str(firtype(b))])
```

```
subplot(2,1,2)
b = firpm(9,[0.2 0.8],[1 1], 'hilbert');
impz(b), title(['Type ' int2str(firtype(b))])
```

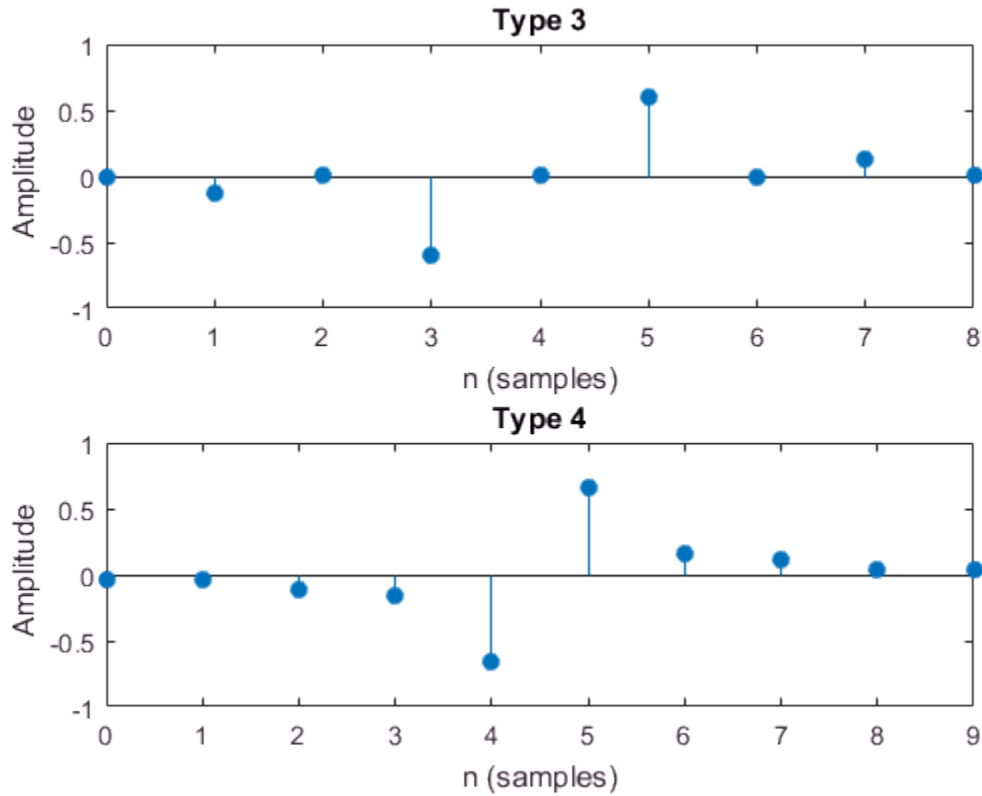

Types of FIR digitalFilter Objects

Use `designfilt` to design the filters from the previous example. Display their types.

```
d1 = designfilt('lowpassfir','DesignMethod','window', ...
               'FilterOrder',8,'CutoffFrequency',0.5);
disp(['d1 is of type ' int2str(firtype(d1))])

d1 is of type 1

d2 = designfilt('lowpassfir','DesignMethod','window', ...
               'FilterOrder',9,'CutoffFrequency',0.5);
disp(['d2 is of type ' int2str(firtype(d2))])
```

```

d2 is of type 2
d3 = designfilt('hilbertfir','DesignMethod','equiripple', ...
               'FilterOrder',8,'TransitionWidth',0.4);
disp(['d3 is of type ' int2str(firtype(d3))])
d3 is of type 3
d4 = designfilt('hilbertfir','DesignMethod','equiripple', ...
               'FilterOrder',9,'TransitionWidth',0.4);
disp(['d4 is of type ' int2str(firtype(d4))])
d4 is of type 4

```

Input Arguments

b — Filter coefficients

vector

Filter coefficients of the FIR filter, specified as a double- or single-precision real-valued row or column vector.

Data Types: double | single

d — FIR filter

digitalFilter object | dfilt object

FIR filter, specified as any of the following:

- A digitalFilter object. Use `designfilt` to generate a digital filter based on frequency-response specifications.
- A `dfilt` filter object.

Output Arguments

t — Filter type

1 | 2 | 3 | 4

Filter type, returned as either 1, 2, 3, or 4. Filter types are defined as follows:

- Type 1 — Even-order symmetric coefficients
- Type 2 — Odd-order symmetric coefficients
- Type 3 — Even-order antisymmetric coefficients
- Type 4 — Odd-order antisymmetric coefficients

See Also

See Also

`designfilt` | `digitalFilter` | `islinphase`

Introduced in R2013a

flattopwin

Flat top weighted window

Syntax

```
w = flattopwin(L)
w = flattopwin(L,sflag)
```

Description

Flat top windows have very low passband ripple (< 0.01 dB) and are used primarily for calibration purposes. Their bandwidth is approximately 2.5 times wider than a Hann window.

`w = flattopwin(L)` returns the L-point symmetric flat top window in column vector `w`.

`w = flattopwin(L,sflag)` returns the L-point symmetric flat top window using `sflag` window sampling, where `sflag` is either `'symmetric'` or `'periodic'`. The `'periodic'` flag is useful for DFT/FFT purposes, such as in spectral analysis. The DFT/FFT contains an implicit periodic extension and the periodic flag enables a signal windowed with a periodic window to have perfect periodic extension. When `'periodic'` is specified, `flattopwin` computes a length `L+1` window and returns the first `L` points. When using windows for filter design, the `'symmetric'` flag should be used.

Examples

Flat Top Window

Create a 64-point symmetric flat top window. View the result using `wvtool`.

```
N = 64;
w = flattopwin(N);
wvtool(w)
```

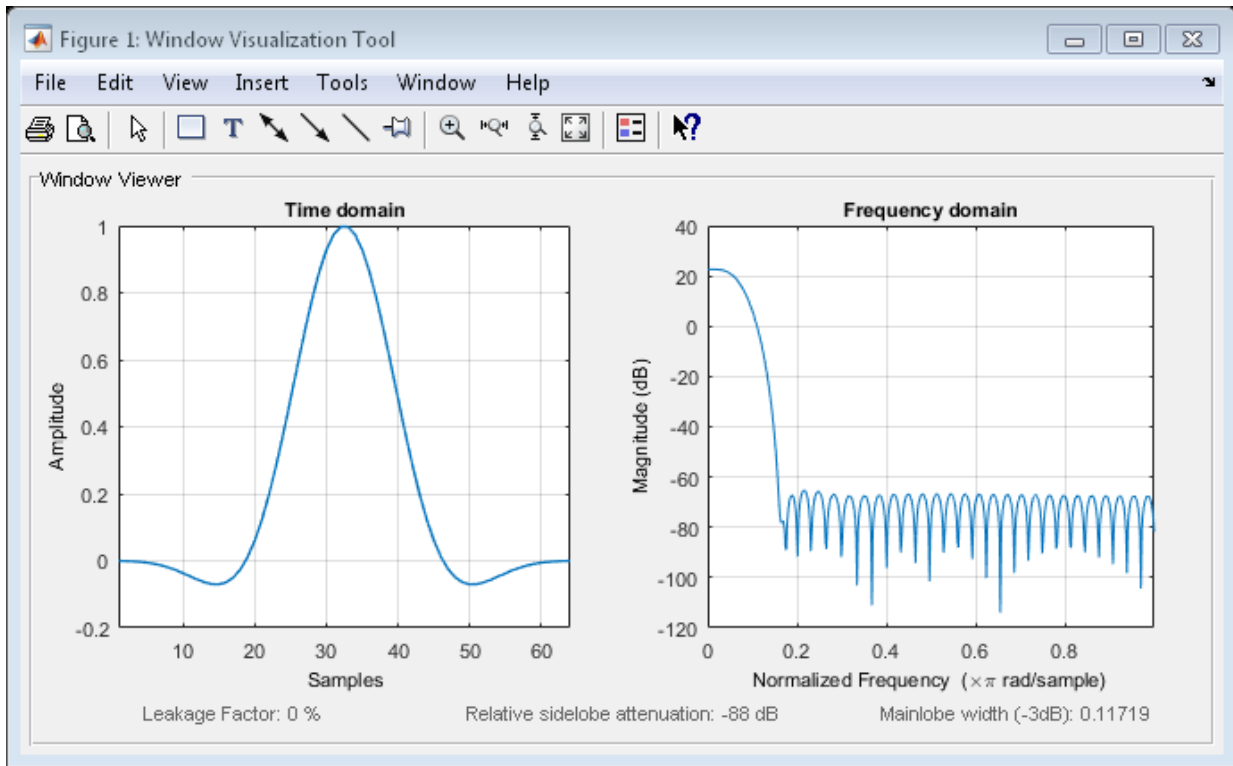

Algorithms

Flat top windows are summations of cosines. The coefficients of a flat top window are computed from the following equation:

$$w(n) = a_0 - a_1 \cos\left(\frac{2\pi n}{N-1}\right) + a_2 \cos\left(\frac{4\pi n}{N-1}\right) - a_3 \cos\left(\frac{6\pi n}{N-1}\right) + a_4 \cos\left(\frac{8\pi n}{N-1}\right),$$

where $0 \leq n \leq N - 1$. The coefficient values are

Coefficient	Value
a_0	0.21557895

Coefficient	Value
a_1	0.41663158
a_2	0.277263158
a_3	0.083578947
a_4	0.006947368

References

- [1] D'Antona, Gabriele, and A. Ferrero. *Digital Signal Processing for Measurement Systems*. New York: Springer Media, 2006, pp. 70–72.
- [2] Gade, Svend, and Henrik Herlufsen. “Use of Weighting Functions in DFT/FFT Analysis (Part I).” *Windows to FFT Analysis (Part I): Brüel & Kjær Technical Review*, No. 3, 1987, pp. 1–28.

Extended Capabilities

C/C++ Code Generation

Generate C and C++ code using MATLAB® Coder™.

Usage notes and limitations:

All inputs must be constants. Expressions or variables are allowed if their values do not change.

See Also

See Also

Apps

Window Designer

Functions

blackman | hamming | hann | window | wvtool

Introduced before R2006a

freqs

Frequency response of analog filters

Syntax

```
h = freqs(b,a,w)
[h,w] = freqs(b,a,n)
freqs
```

Description

`freqs` returns the complex frequency response $H(j\omega)$ (Laplace transform) of an analog filter

$$H(s) = \frac{B(s)}{A(s)} = \frac{b(1)s^n + b(2)s^{n-1} + \dots + b(n+1)}{a(1)s^m + a(2)s^{m-1} + \dots + a(m+1)}$$

given the numerator and denominator coefficients in vectors **b** and **a**.

`h = freqs(b,a,w)` returns the complex frequency response of the analog filter specified by coefficient vectors **b** and **a**. `freqs` evaluates the frequency response along the imaginary axis in the complex plane at the angular frequencies in rad/s specified in real vector **w**, where **w** is a vector containing more than one frequency.

`[h,w] = freqs(b,a,n)` uses **n** frequency points to compute the frequency response, **h**, where **n** is a real, scalar value. The frequency vector **w** is auto-generated and has length **n**. If you omit **n** as an input, 200 frequency points are used. If you do not need the generated frequency vector returned, you can use the form `h = freqs(b,a,n)` to return only the frequency response, **h**.

`freqs` with no output arguments plots the magnitude and phase response versus frequency in the current figure window.

`freqs` works only for real input systems and positive frequencies.

Examples

Frequency Response from the Transfer Function

Find and graph the frequency response of the transfer function

$$H(s) = \frac{0.2s^2 + 0.3s + 1}{s^2 + 0.4s + 1}.$$

```
a = [1 0.4 1];  
b = [0.2 0.3 1];  
w = logspace(-1,1);  
freqs(b,a,w)
```

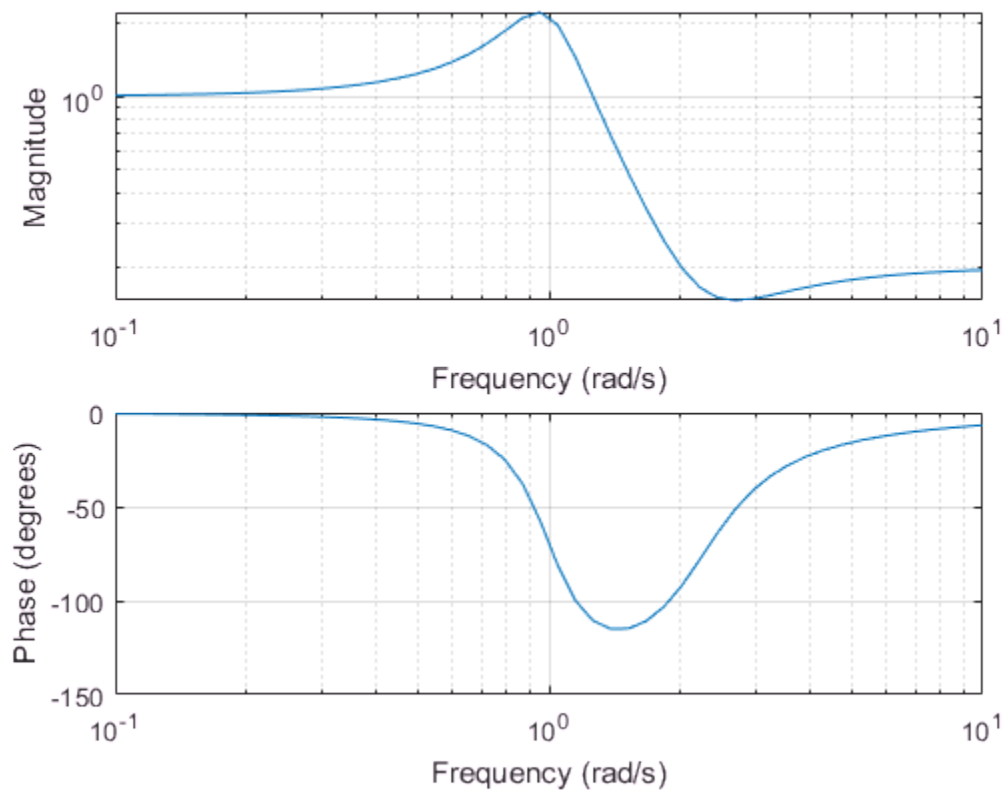

You can also compute the results and use them to generate the plots.

```
h = freqs(b,a,w);  
mag = abs(h);  
phase = angle(h);  
phasedeg = phase*180/pi;
```

```
subplot(2,1,1), loglog(w,mag), grid on  
xlabel 'Frequency (rad/s)', ylabel 'Magnitude'  
subplot(2,1,2), semilogx(w,phasedeg), grid on  
xlabel 'Frequency (rad/s)', ylabel 'Phase (degrees)'
```

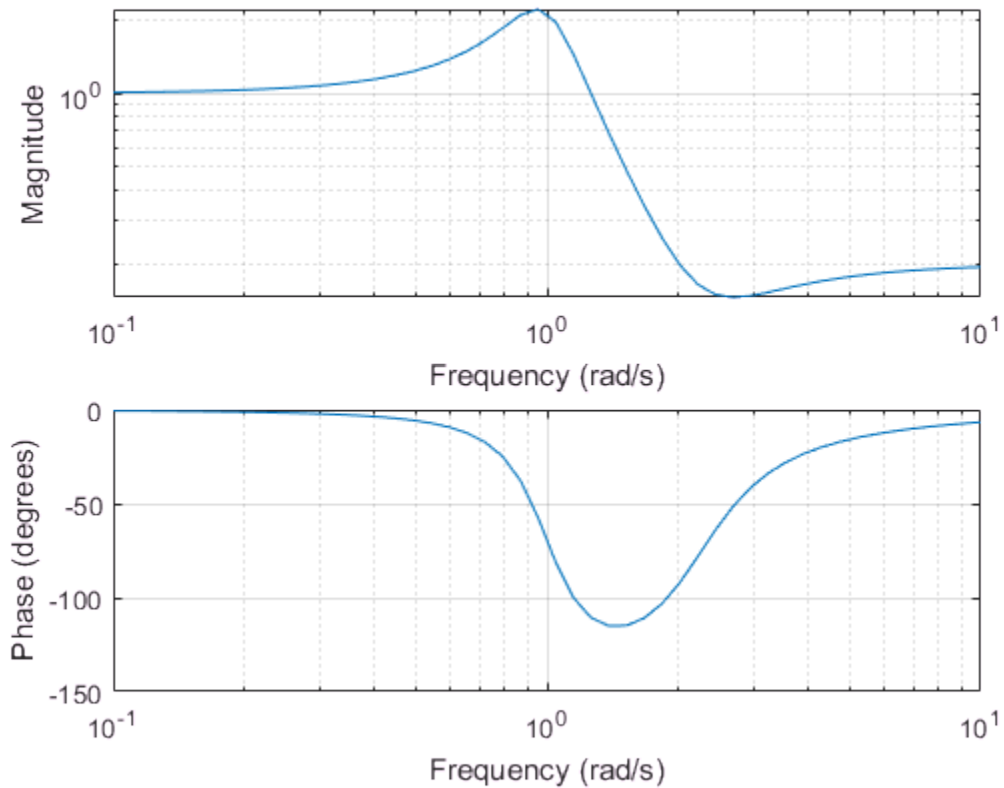

Frequency Response of a Lowpass Analog Bessel Filter

Design a 5th-order analog lowpass Bessel filter with an approximately constant group delay up to 10^4 rad/s. Plot the frequency response of the filter using `freqs`.

```
[b,a] = besself(5,10000); % Bessel analog filter design  
freqs(b,a)                % Plot frequency response
```

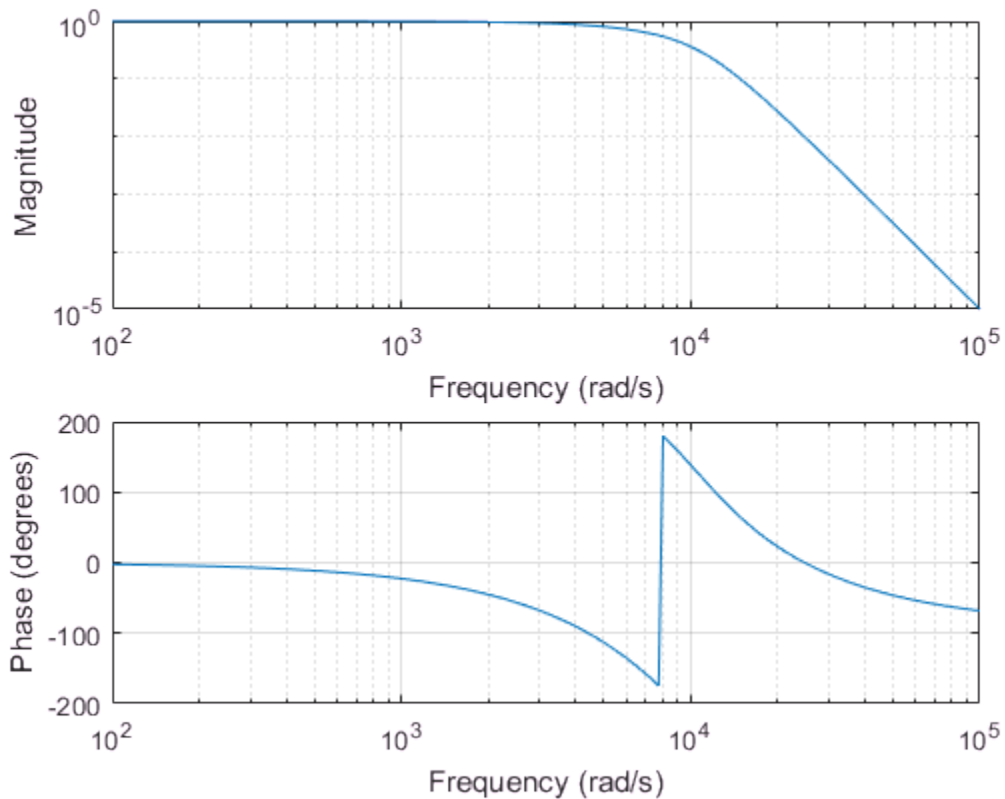

Algorithms

`freqs` evaluates the polynomials at each frequency point, then divides the numerator response by the denominator response:

```
s = i*w;  
h = polyval(b,s)./polyval(a,s);
```

See Also

abs | angle | freqz | invfreqs | logspace | polyval

Introduced before R2006a

freqsamp

Real or complex frequency-sampled FIR filter from specification object

Syntax

```
hd = design(d, 'freqsamp')
hd = design(..., 'FilterStructure', structure)
hd = design(..., 'Window', window)
```

Description

`hd = design(d, 'freqsamp')` designs a frequency-sampled filter specified by the filter specifications object `d`.

`hd = design(..., 'FilterStructure', structure)` returns a filter with the filter structure you specify by the `structure` input argument. `structure` is `dffir` by default and can be any one of the following filter structures.

Structure	Description of Resulting Filter
<code>dffir</code>	Direct-form FIR filter
<code>dffirt</code>	Transposed direct-form FIR filter
<code>dfsymfir</code>	Symmetrical direct-form FIR filter
<code>dfasymfir</code>	Asymmetrical direct-form FIR filter
<code>fftfir</code>	Fast Fourier transform FIR filter

`hd = design(..., 'Window', window)` designs filters using the window specified in `window`. Provide the input argument `window` as

- The window name in single quotes. For example, use `'bartlett'`, or `'hamming'`. See `window` for the full list of available windows.
- A function handle that references the `window` function. When the `window` function requires more than one input, use a cell array to hold the required arguments. The first example shows a cell array input argument.

- The window vector itself.

Examples

Filters with Arbitrary Magnitude Response

Design FIR filters that have arbitrary magnitude responses.

Initially, generate a real filter whose response has three distinct sections:

- A sinusoidal response section for lower frequencies
- A piecewise linear response section for intermediate frequencies
- A quadratic response section for higher frequencies.

```
b1 = 0:0.01:0.18;
a1 = 0.5+sin(2*pi*7.5*b1)/4;

b2 = [0.2 0.38 0.4 0.55 0.562 0.585 0.6 0.78];
a2 = [0.5 2.3 1 1 -0.2 -0.2 1 1];

b3 = [0.79:0.01:1];
a3 = 0.2+18*(1-b3).^2;

f = [b1 b2 b3];
a = [a1 a2 a3];
n = 300;
```

Design the filter using a Kaiser window with $\beta = 50$;

```
d = fdesign.arbmag('n,f,a',n,f,a);
hd = design(d,'freqsamp','Window',{@kaiser,50});
fvtool(hd)
```

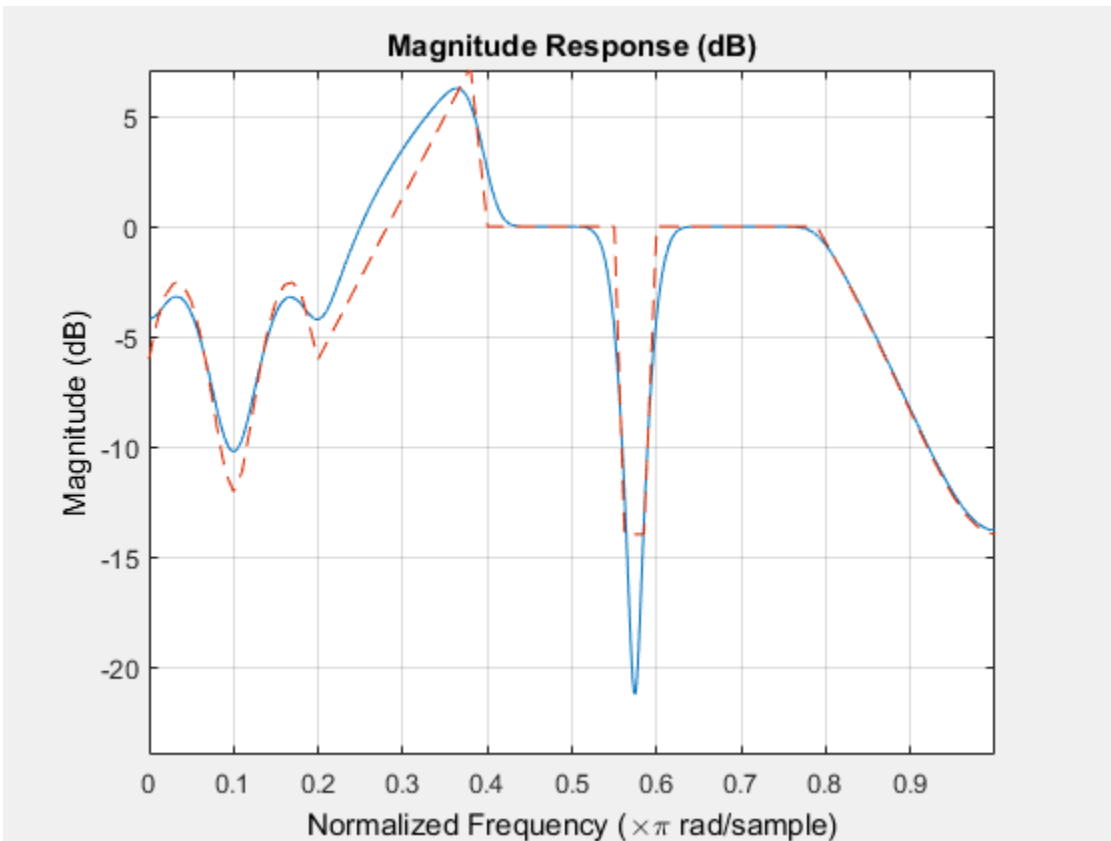

Design an arbitrary-magnitude complex FIR filter. The vector `f` contains frequency locations. The vector `a` contains the desired filter response values at the locations specified in `f`. Use a rectangular window for the design.

```
f = [-1 -0.93443 -0.86885 -0.80328 -0.7377 -0.67213 -0.60656 -0.54098 ...
     -0.47541 -0.40984 -0.34426 -0.27869 -0.21311 -0.14754 -0.081967 ...
     -0.016393 0.04918 0.11475 0.18033 0.2459 0.31148 0.37705 0.44262 ...
     0.5082 0.57377 0.63934 0.70492 0.77049 0.83607 0.90164 1];
```

```
a = [0.0095848 0.021972 0.047249 0.099869 0.23119 0.57569 0.94032 ...
     0.98084 0.99707 0.99565 0.9958 0.99899 0.99402 0.99978 ...
     0.99995 0.99733 0.99731 0.96979 0.94936 0.8196 0.28502 ...
     0.065469 0.0044517 0.018164 0.023305 0.02397 0.023141 0.021341 ...
     0.019364 0.017379 0.016061];
```



```
n = 48;  
  
d = fdesign.arbmag('n,f,a',n,f,a);  
hdc = design(d,'fregsamp','Window','rectwin');  
fvtool(hdc)
```

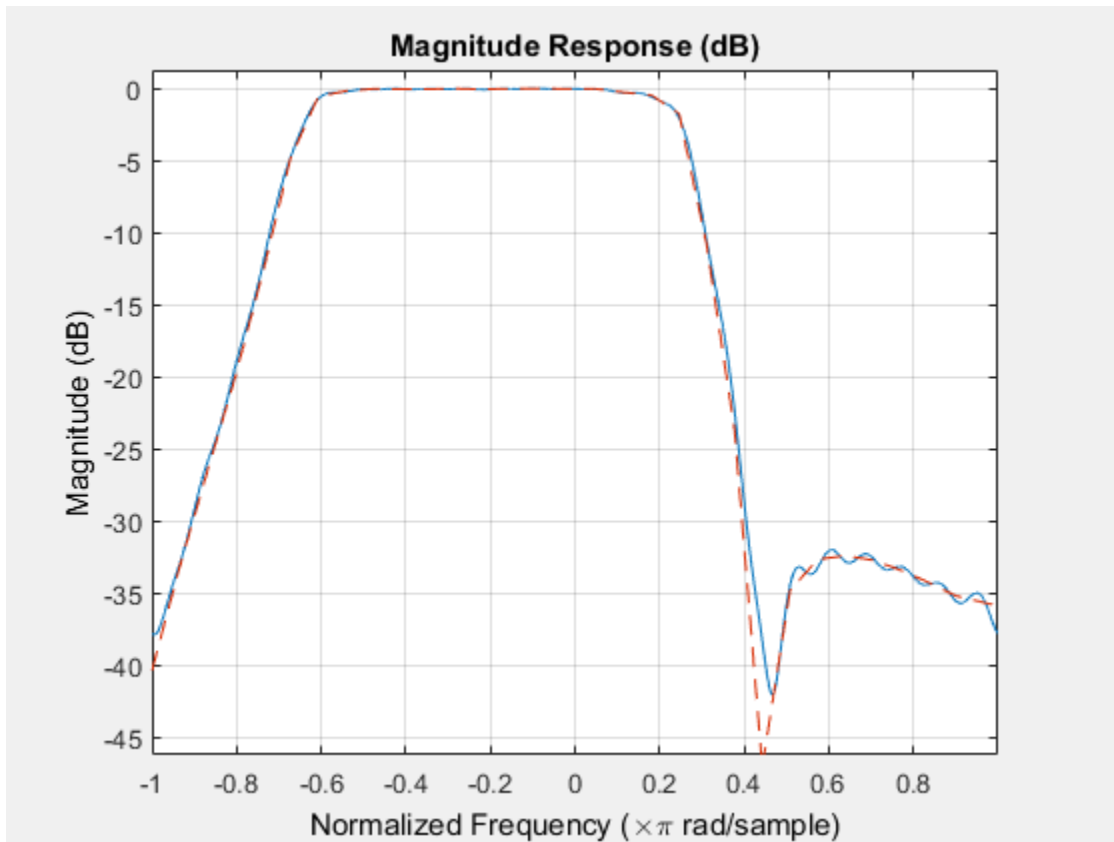

FVTool shows the response for `hdc` from -1 to 1 in normalized frequency because the filter's transfer function is not symmetric around 0. Since the Fourier transform of the filter does not exhibit conjugate symmetry, `design` returns a complex-valued filter.

See Also

See Also

Apps

Filter Designer

Functions

`designfilt` | `fdesign`

Introduced in R2009a

freqz

Frequency response of digital filter

Syntax

```
[h,w] = freqz(b,a,n)
[h,w] = freqz(sos,n)
[h,w] = freqz(d,n)
[h,w] = freqz( ____,n,'whole' )

[h,f] = freqz( ____,n,fs)
[h,f] = freqz( ____,n,'whole',fs)

h = freqz( ____,w)
h = freqz( ____,f,fs)

freqz( ____)
```

Description

`[h,w] = freqz(b,a,n)` returns the n -point frequency response vector, h , and the corresponding angular frequency vector, w , for the digital filter with numerator and denominator polynomial coefficients stored in \mathbf{b} and \mathbf{a} , respectively.

`[h,w] = freqz(sos,n)` returns the n -point complex frequency response corresponding to the second-order sections matrix, \mathbf{sos} .

`[h,w] = freqz(d,n)` returns the n -point complex frequency response for the digital filter, \mathbf{d} .

`[h,w] = freqz(____,n,'whole')` returns the frequency response at n sample points around the entire unit circle.

`[h,f] = freqz(____,n,fs)` returns the frequency response vector, h , and the corresponding physical frequency vector, f , for the digital filter with numerator and

denominator polynomial coefficients stored in `b` and `a`, respectively, given the sampling frequency, `fs`.

`[h,f] = freqz(____, n, 'whole', fs)` returns the frequency at `n` points ranging between 0 and `fs`.

`h = freqz(____, w)` returns the frequency response vector, `h`, at the normalized frequencies supplied in `w`.

`h = freqz(____, f, fs)` returns the frequency response vector, `h`, at the physical frequencies supplied in `f`.

`freqz(____,)` with no output arguments plots the frequency response of the filter.

Note: If the input to `freqz` is single precision, the frequency response is calculated using single-precision arithmetic. The output, `h`, is single precision.

Examples

Frequency Response from Transfer Function

Compute and display the magnitude response of the third-order IIR lowpass filter described by the following transfer function:

$$H(z) = \frac{0.05634(1 + z^{-1})(1 - 1.0166z^{-1} + z^{-2})}{(1 - 0.683z^{-1})(1 - 1.4461z^{-1} + 0.7957z^{-2})}$$

Express the numerator and denominator as polynomial convolutions. Find the frequency response at 2001 points spanning the complete unit circle.

```
b0 = 0.05634;
b1 = [1 1];
b2 = [1 -1.0166 1];
a1 = [1 -0.683];
a2 = [1 -1.4461 0.7957];

b = b0*conv(b1,b2);
a = conv(a1,a2);

[h,w] = freqz(b,a,'whole',2001);
```

Plot the magnitude response expressed in decibels.

```
plot(w/pi,20*log10(abs(h)))  
ax = gca;  
ax.YLim = [-100 20];  
ax.XTick = 0:.5:2;  
xlabel('Normalized Frequency (\times\pi rad/sample)')  
ylabel('Magnitude (dB)')
```

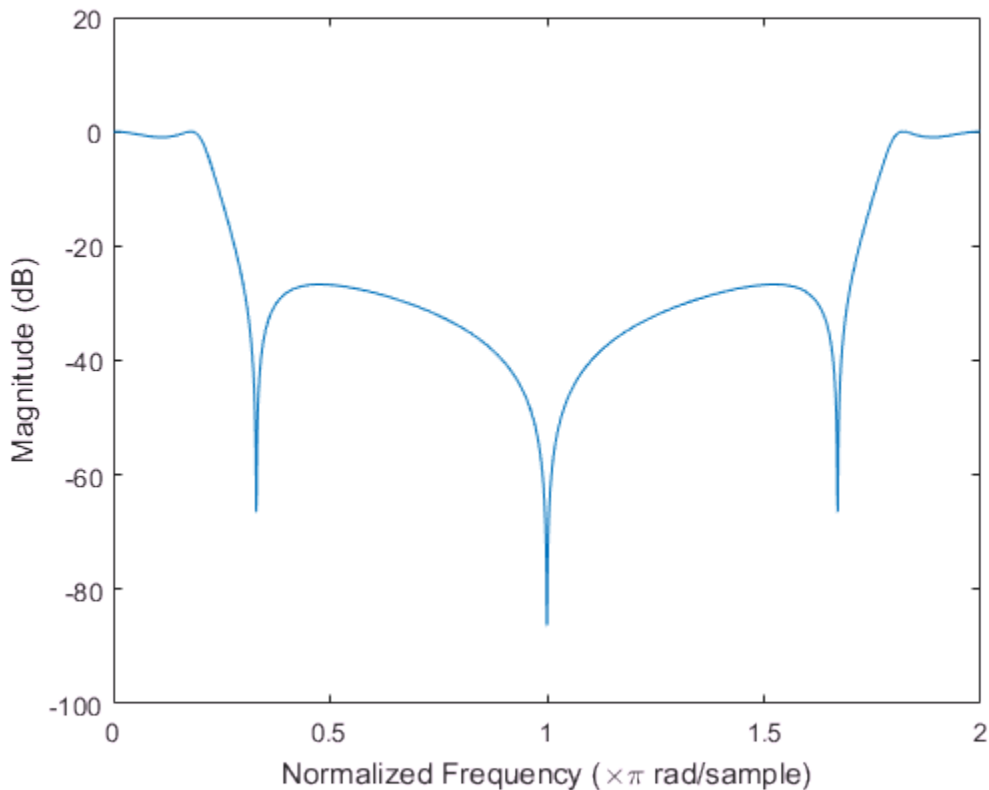

Frequency Response from Second-Order Sections

Compute and display the magnitude response of the third-order IIR lowpass filter described by the following transfer function:

$$H(z) = \frac{0.05634(1 + z^{-1})(1 - 1.0166z^{-1} + z^{-2})}{(1 - 0.683z^{-1})(1 - 1.4461z^{-1} + 0.7957z^{-2})}$$

Express the transfer function in terms of second-order sections. Find the frequency response at 2001 points spanning the complete unit circle.

```
b0 = 0.05634;  
b1 = [1 1];  
b2 = [1 -1.0166 1];  
a1 = [1 -0.683];  
a2 = [1 -1.4461 0.7957];
```

```
sos1 = [b0*[b1 0] [a1 0]];  
sos2 = [b2 a2];
```

```
[h,w] = freqz([sos1;sos2], 'whole', 2001);
```

Plot the magnitude response expressed in decibels.

```
plot(w/pi, 20*log10(abs(h)))  
ax = gca;  
ax.YLim = [-100 20];  
ax.XTick = 0:.5:2;  
xlabel('Normalized Frequency (\times\pi rad/sample)')  
ylabel('Magnitude (dB)')
```

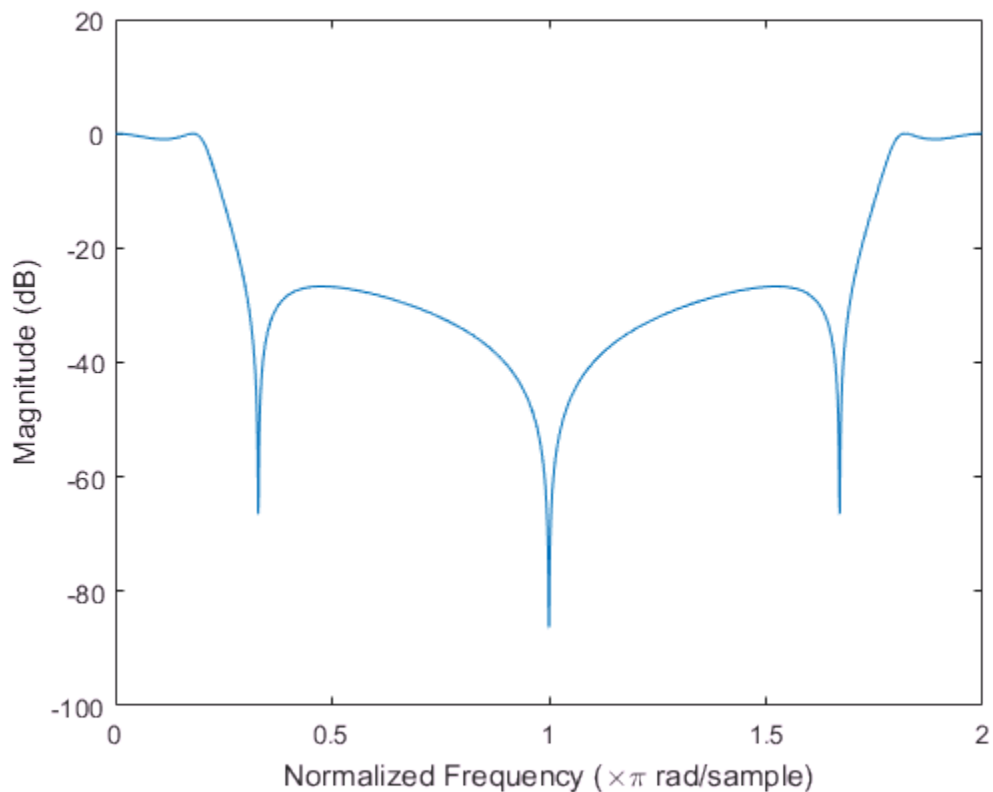

Frequency Response of an FIR filter

Design an FIR lowpass filter of order 80 using a Kaiser window with $\beta = 8$. Specify a normalized cutoff frequency of 0.5π rad/sample. Display the magnitude and phase responses of the filter.

```
b = fir1(80,0.5,kaiser(81,8));  
freqz(b,1)
```

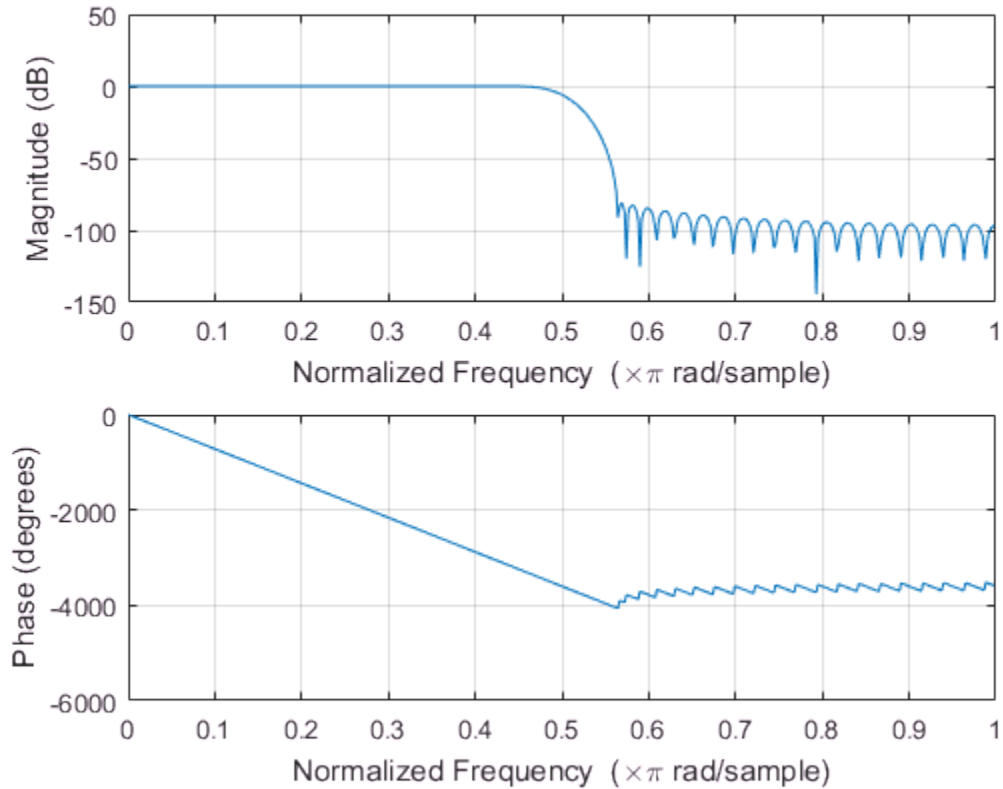

Design the same filter using `designfilt`. Display its magnitude and phase responses using `fvtool`.

```
d = designfilt('lowpassfir','FilterOrder',80, ...  
              'CutoffFrequency',0.5,'Window',{'kaiser',8});  
freqz(d)
```

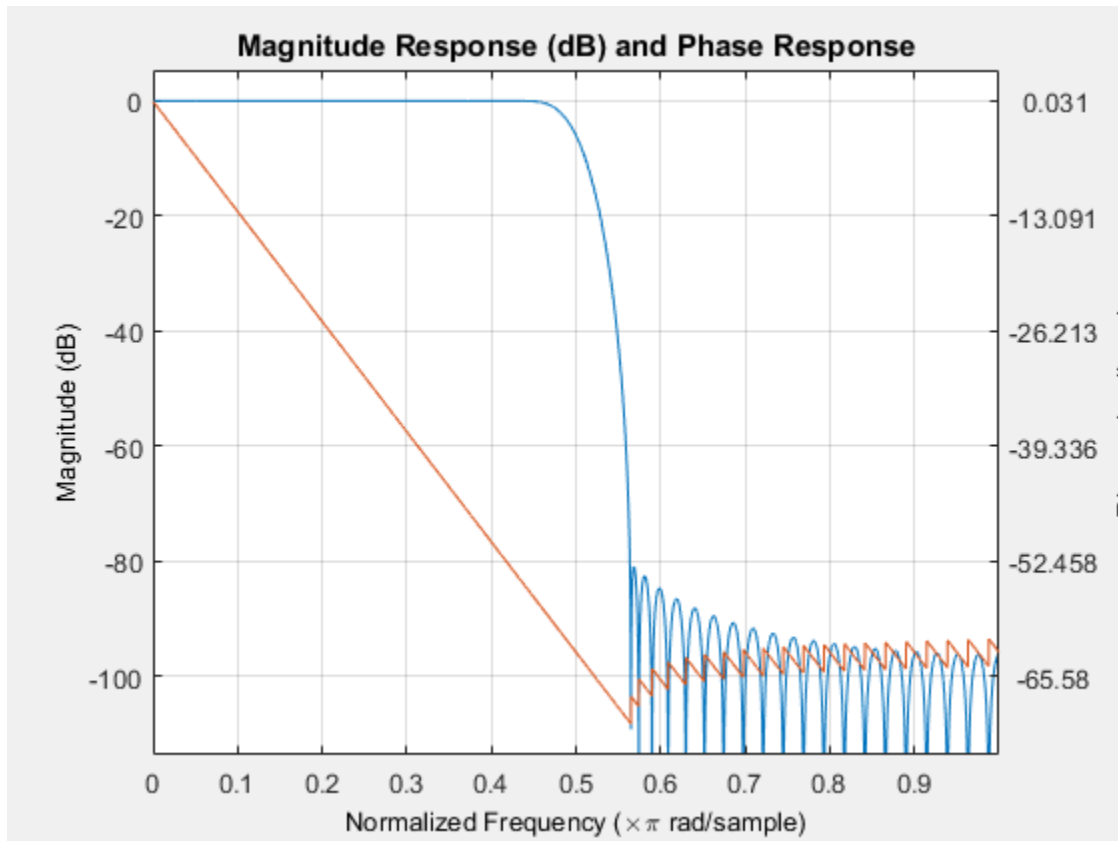
Frequency Response of an FIR Bandpass Filter

Design an FIR bandpass filter with passband between 0.35π and 0.8π rad/sample and 3 dB of ripple. The first stopband goes from 0 to 0.1π rad/sample and has an attenuation of 40 dB. The second stopband goes from 0.9π rad/sample to the Nyquist frequency and has an attenuation of 30 dB. Compute the frequency response. Plot its magnitude in both linear units and decibels. Highlight the passband.

```
sf1 = 0.1;
pf1 = 0.35;
pf2 = 0.8;
sf2 = 0.9;
```

```
pb = linspace(pf1,pf2,1e3)*pi;

bp = designfilt('bandpassfir', ...
    'StopbandAttenuation1',40, 'StopbandFrequency1',sf1,...
    'PassbandFrequency1',pf1,'PassbandRipple',3,'PassbandFrequency2',pf2, ...
    'StopbandFrequency2',sf2,'StopbandAttenuation2',30);

[h,w] = freqz(bp,1024);
hpb = freqz(bp,pb);

subplot(2,1,1)
plot(w/pi,abs(h),pb/pi,abs(hpb),'.-')
axis([0 1 -1 2])
legend('Response','Passband','Location','South')
ylabel('Magnitude')

subplot(2,1,2)
plot(w/pi,db(h),pb/pi,db(hpb),'.-')
axis([0 1 -60 10])
xlabel('Normalized Frequency (\times\pi rad/sample)')
ylabel('Magnitude (dB)')
```

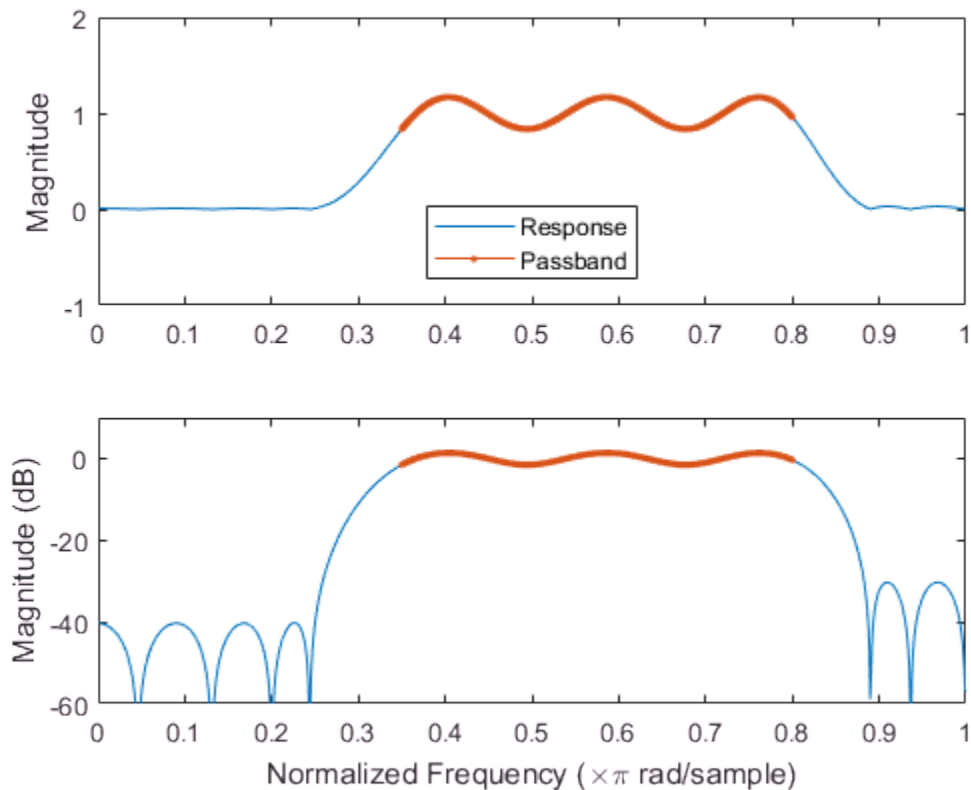

Input Arguments

b, a — Transfer function coefficients

vectors

Transfer function coefficients, specified as vectors. Express the transfer function in terms of **b** and **a** as

$$H(e^{j\omega}) = \frac{B(e^{j\omega})}{A(e^{j\omega})} = \frac{b(1) + b(2)e^{-j\omega} + b(3)e^{-j2\omega} + \dots + b(M)e^{-j(M-1)\omega}}{a(1) + a(2)e^{-j\omega} + a(3)e^{-j2\omega} + \dots + a(N)e^{-j(N-1)\omega}}$$

Example: $b = [1 \ 3 \ 3 \ 1]/6$ and $a = [3 \ 0 \ 1 \ 0]/3$ specify a third-order Butterworth filter with normalized 3-dB frequency 0.5π rad/sample.

Data Types: `double` | `single`

Complex Number Support: Yes

n — Number of evaluation points

512 (default) | positive integer scalar

Number of evaluation points, specified as a positive integer scalar no less than 2. When n is absent, it defaults to 512. For best results, set n to a value greater than the filter order.

Data Types: `double`

sos — Second-order section coefficients

matrix

Second-order section coefficients, specified as a matrix. `sos` is a K -by-6 matrix, where the number of sections, K , must be greater than or equal to 2. If the number of sections is less than 2, `freqz` considers the input to be a numerator vector. Each row of `sos` corresponds to the coefficients of a second-order (biquad) filter. The i th row of `sos` corresponds to `[bi(1) bi(2) bi(3) ai(1) ai(2) ai(3)]`.

Example: $s = [2 \ 4 \ 2 \ 6 \ 0 \ 2; 3 \ 3 \ 0 \ 6 \ 0 \ 0]$ specifies a third-order Butterworth filter with normalized 3-dB frequency 0.5π rad/sample.

Data Types: `double` | `single`

Complex Number Support: Yes

d — Digital filter

`digitalFilter` object

Digital filter, specified as a `digitalFilter` object. Use `designfilt` to generate a digital filter based on frequency-response specifications.

Example: `d = designfilt('lowpassiir','FilterOrder',3,'HalfPowerFrequency',0.5)` specifies a third-order Butterworth filter with normalized 3-dB frequency 0.5π rad/sample.

fs — Sampling rate

positive scalar

Sampling rate, specified as a positive scalar. When the unit of time is seconds, `fs` is expressed in hertz.

Data Types: double

w — Angular frequencies

vector

Angular frequencies, specified as a vector and expressed in radians/sample. *w* must have at least two elements. $w = \pi$ corresponds to the Nyquist frequency.

f — Frequencies

vector

Frequencies, specified as a vector. *f* must have at least two elements. When the unit of time is seconds, *f* is expressed in hertz.

Data Types: double

Output Arguments

h — Frequency response

vector

Frequency response, returned as a vector. If you specify *n*, *h* has length *n*. If you do not specify *n*, or specify *n* as the empty vector, *h* has length 512.

w — Angular frequencies

vector

Angular frequencies, returned as a vector. *w* has values ranging from 0 to π . If you specify 'whole' in your input, the values in *w* range from 0 to 2π . If you specify *n*, *w* has length *n*. If you do not specify *n*, or specify *n* as the empty vector, *w* has length 512.

f — Frequencies

vector

Frequencies, returned as a vector expressed in hertz. *f* has values ranging from 0 to $f_s/2$ Hz. If you specify 'whole' in your input, the values in *f* range from 0 to f_s Hz. If you specify *n*, *f* has length *n*. If you do not specify *n*, or specify *n* as the empty vector, *f* has length 512.

Algorithms

The frequency response of a digital filter can be interpreted as the transfer function evaluated at $z = e^{j\omega}$ [1].

`freqz` determines the transfer function from the (real or complex) numerator and denominator polynomials you specify and returns the complex frequency response, $H(e^{j\omega})$, of a digital filter. The frequency response is evaluated at sample points determined by the syntax that you use.

`freqz` generally uses an FFT algorithm to compute the frequency response whenever you don't supply a vector of frequencies as an input argument. It computes the frequency response as the ratio of the transformed numerator and denominator coefficients, padded with zeros to the desired length.

When you do supply a vector of frequencies as an input argument, `freqz` evaluates the polynomials at each frequency point using Horner's method of nested polynomial evaluation, dividing the numerator response by the denominator response.

References

- [1] Oppenheim, Alan V., Ronald W. Schaffer, and John R. Buck. *Discrete-Time Signal Processing*. 2nd Ed. Upper Saddle River, NJ: Prentice Hall, 1999.

Extended Capabilities

C/C++ Code Generation

Generate C and C++ code using MATLAB® Coder™.

Usage notes and limitations:

- Does not support variable-size inputs.
- When called with no output arguments, and without a semicolon at the end, `freqz` returns the complex frequency response of the input filter, evaluated at 512 points.

If the semicolon is added, the function produces a plot of the magnitude and phase response of the filter.

See “freqz With No Output Arguments”.

See Also

See Also

`digitalFilter` | `abs` | `angle` | `designfilt` | `fft` | `filter` | `freqs` | `impz` | `invfreqs`
| `logspace`

Introduced before R2006a

fsst

Fourier synchrosqueezed transform

Syntax

```
s = fsst(x)
[s,w,n] = fsst(x)

[s,f,t] = fsst(x,fs)
[s,f,t] = fsst(x,ts)

[ ___ ] = fsst( ___ ,window)

fsst( ___ )
fsst( ___ ,freqloc)
```

Description

`s = fsst(x)` returns the Fourier synchrosqueezed transform of the input signal, `x`. Each column of `s` contains the synchrosqueezed spectrum of a windowed segment of `x`.

`[s,w,n] = fsst(x)` returns a vector of normalized frequencies, `w`, and a vector of sample numbers, `n`, at which the Fourier synchrosqueezed transform is computed. `w` corresponds to the columns of `s` and `n` corresponds to the rows of `s`.

`[s,f,t] = fsst(x,fs)` returns a vector of cyclical frequencies, `f`, and a vector of time instants, `t`, expressed in terms of the sample rate, `fs`.

`[s,f,t] = fsst(x,ts)` specifies the sample time, `ts`, as a **duration** scalar. `t` is in the same units as `ts`. The units of `f` are reciprocal to the units of `ts`.

`[___] = fsst(___ ,window)` uses `window` to divide the signal into segments and perform windowing. You can use any combination of input arguments from previous syntaxes to obtain the corresponding output arguments.

`fsst(___)` with no output arguments plots the synchrosqueezed transform in the current figure window.

`fsst(____, freqloc)` specifies the axis on which to plot the frequency.

Examples

Fourier Synchronsqueezed Transform of Sinusoidal Signal

Generate 1024 samples of a signal that consists of a sum of sinusoids embedded in white Gaussian noise. The normalized frequencies of the sinusoids are $2\pi/5$ rad/sample and $4\pi/5$ rad/sample. The higher frequency sinusoid has 3 times the amplitude of the other sinusoid.

```
N = 1024;  
n = 0:N-1;  
  
w0 = 2*pi/5;  
x = sin(w0*n)+3*sin(2*w0*n);
```

Compute the Fourier synchronsqueezed transform of the signal. Plot the result.

```
[s,w,n] = fsst(x);  
  
mesh(n,w/pi,abs(s))  
  
axis tight  
view(2)  
colorbar
```

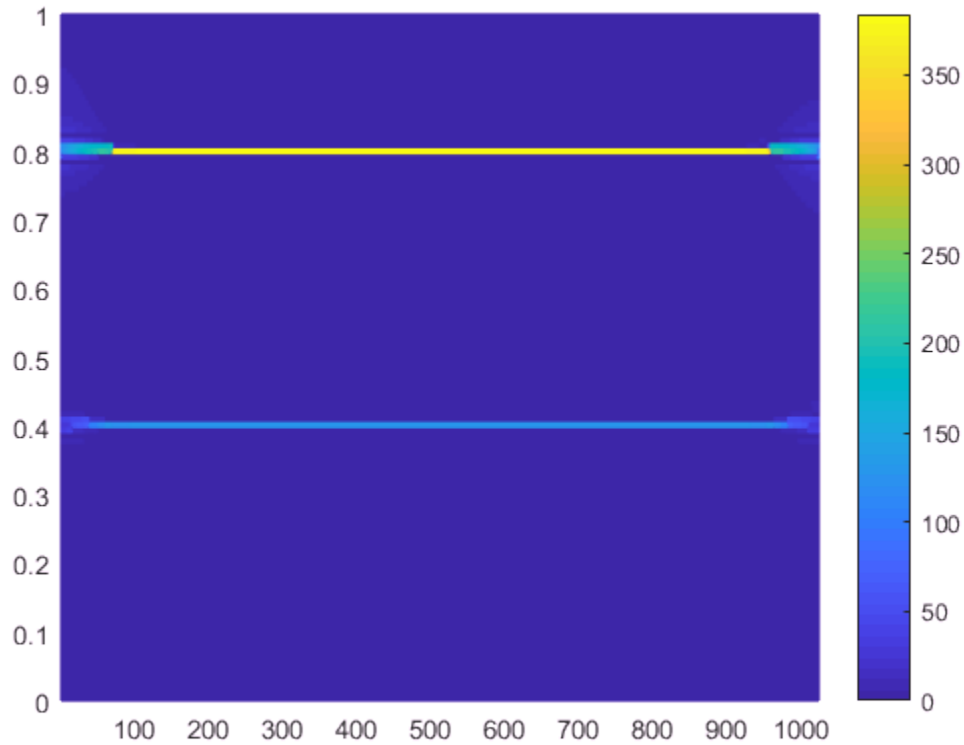

Compute the conventional short-time Fourier transform of the signal for comparison. Use the default values of `spectrogram`. Plot the result.

```
[s,w,n] = spectrogram(x);  
surf(n,w/pi,abs(s), 'EdgeColor', 'none')  
  
axis tight  
view(2)  
colorbar
```

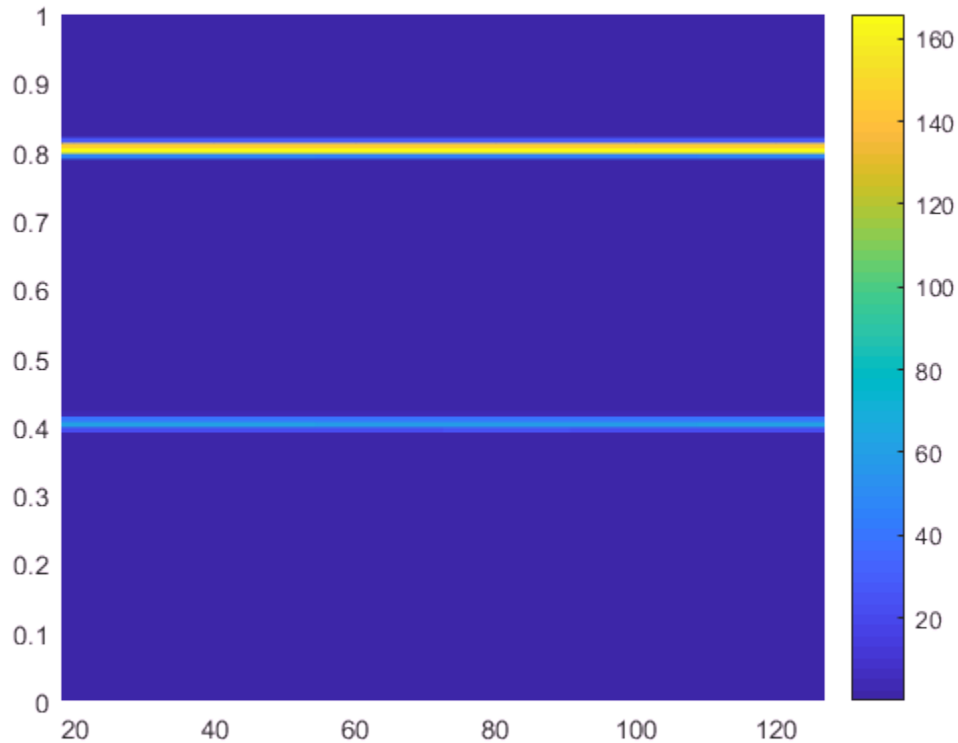

Synchrosqueezed Transform of Linear Chirps

Generate a signal that consists of two chirps. The signal is sampled at 3 kHz for one second. The first chirp has an initial frequency of 400 Hz and reaches 800 Hz at the end of the sampling. The second chirp starts at 500 Hz and reaches 1000 Hz at the end. The second chirp has twice the amplitude of the first chirp.

```
fs = 3000;  
t = 0:1/fs:1-1/fs;  
  
x1 = chirp(t,400,t(end),800);  
x2 = 2*chirp(t,500,t(end),1000);
```

Compute and plot the Fourier synchrosqueezed transform of the signal.

```
fsst(x1+x2,fs,'yaxis')
```

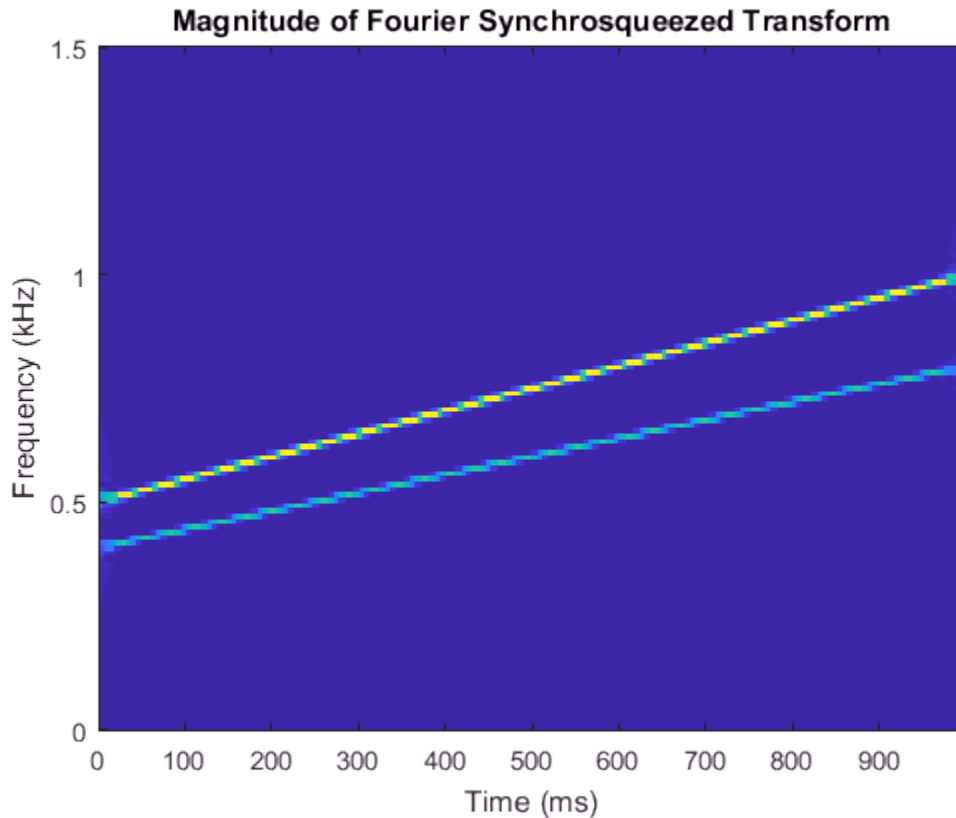

Compare the synchrosqueezed transform with the short-time Fourier transform (STFT). Compute the STFT using the `spectrogram` function. Specify the default parameters used by `fsst`:

- A 256-point Kaiser window with $\beta = 10$ to window the signal
- An overlap of 255 samples between adjoining windowed segments
- An FFT length of 256

```
[stft,f,t] = spectrogram(x1+x2,kaiser(256,10),255,256,fs);
```

Plot the absolute value of the STFT.

```
mesh(t,f,abs(stft))  
  
xlabel('Time (s)')  
ylabel('Frequency (Hz)')  
title('Short-Time Fourier Transform')  
axis tight  
view(2)
```

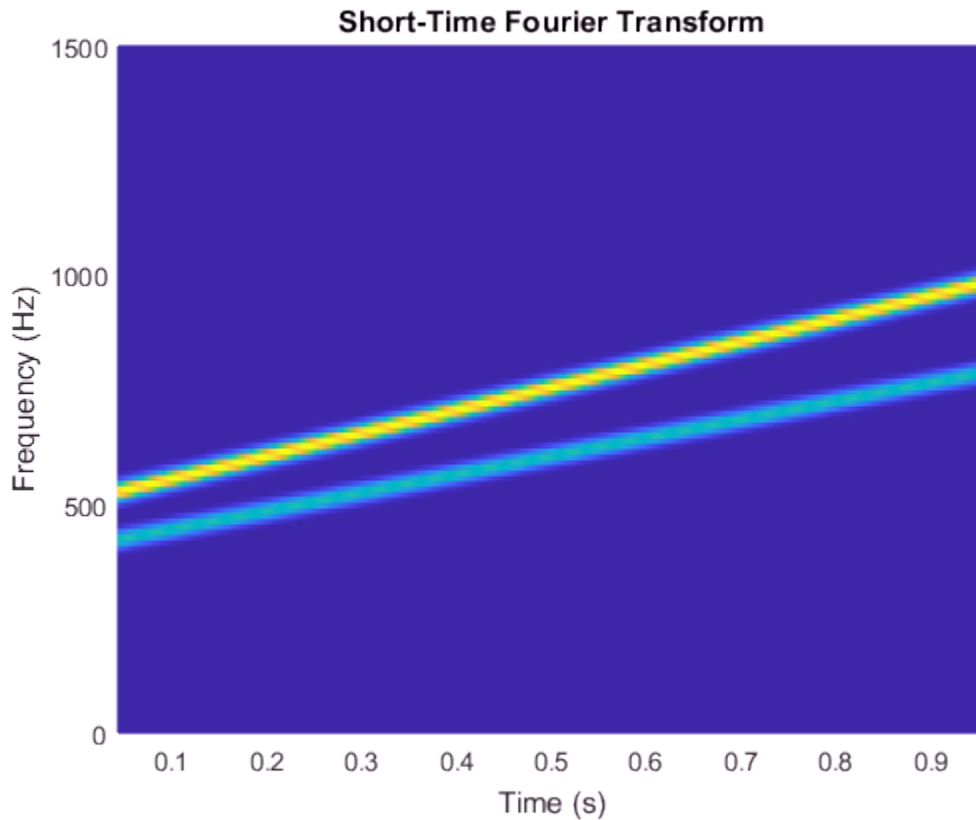

Fourier Synchrosqueezed Transform of Chirps

Compute and display the Fourier synchrosqueezed transform of a quadratic chirp that starts at 100 Hz and crosses 200 Hz at $t = 1$ s. Specify a sample rate of 1 kHz. Express the sample time as a `duration` scalar.

```
fs = 1000;
t = 0:1/fs:2;
ts = duration(0,0,1/fs);

x = chirp(t,100,1,200,'quadratic');

fsst(x,ts,'yaxis')

title('Quadratic Chirp')
```

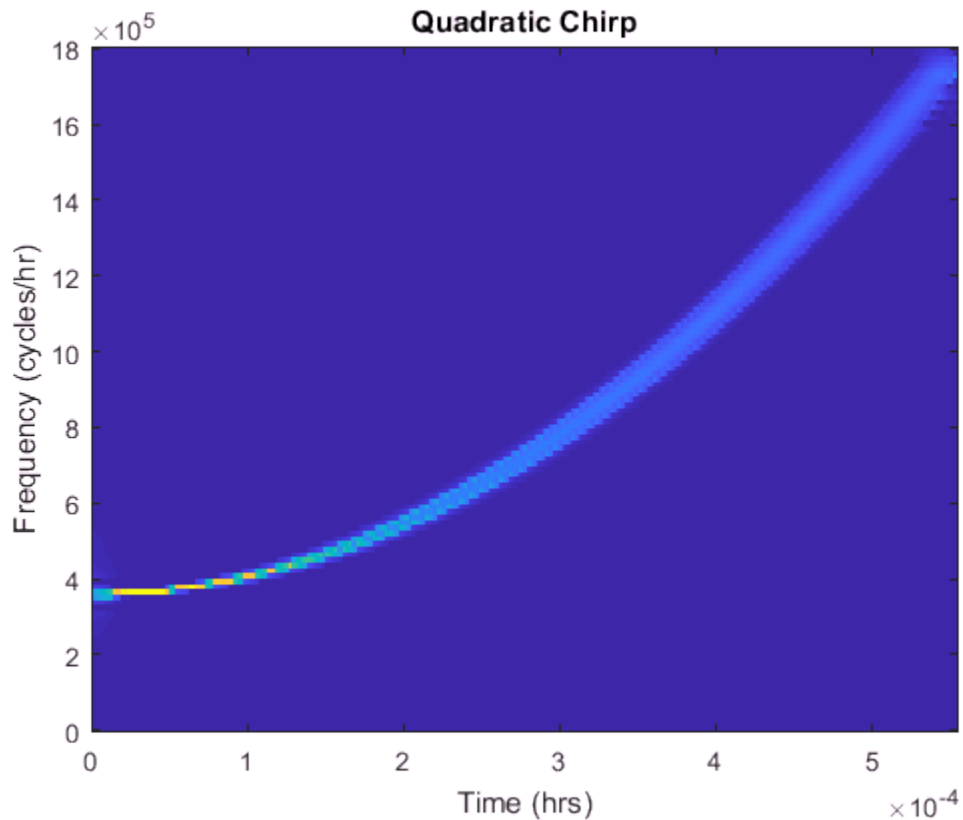

The synchrosqueezing algorithm works under the assumption that the frequency of the signal varies slowly. Thus the spectrum is better concentrated at early times, where the rate of change of frequency is smaller.

Compute and display the Fourier synchrosqueezed transform of a linear chirp that starts at DC and crosses 150 Hz at $t = 1$ s. Use a 256-sample Hamming window.

```
x = chirp(t,0,1,150);
fsst(x,ts,hamming(256),'yaxis')
title('Linear Chirp')
```

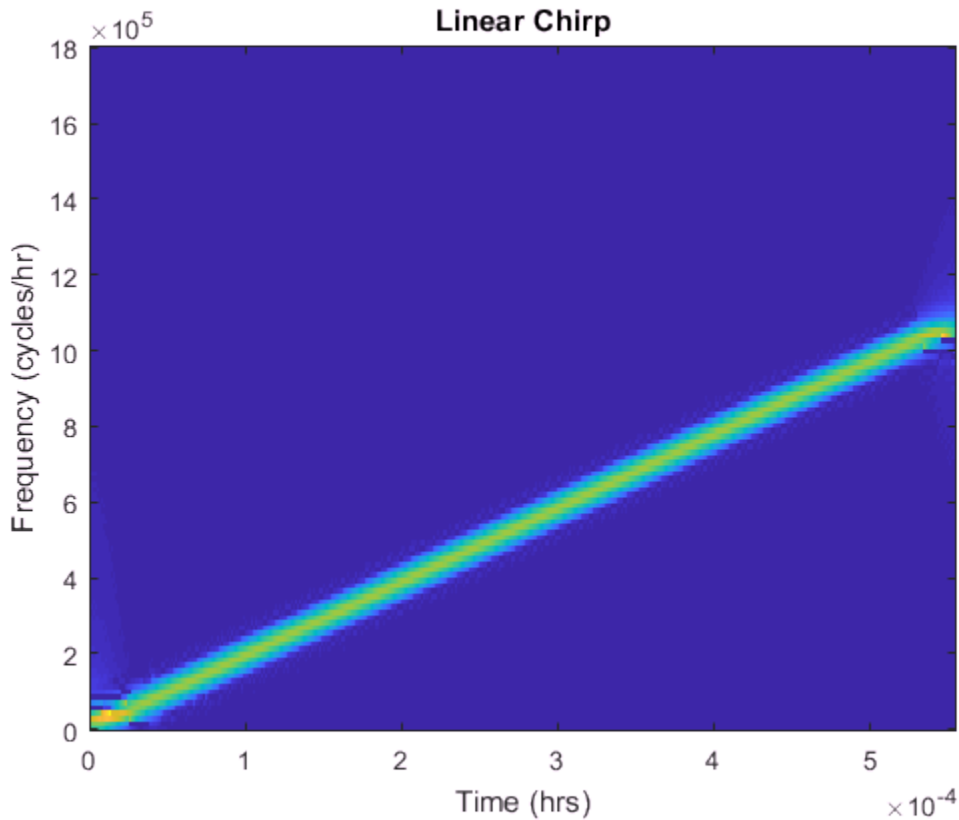

Compute and display the Fourier synchrosqueezed transform of a logarithmic chirp. The chirp is sampled at 1 kHz, starts at 20 Hz, and crosses 60 Hz at $t = 1$ s. Use a 256-sample Kaiser window with $\beta = 20$.

```
x = chirp(t,20,1,60,'logarithmic');
```

```
[s,f,t] = fsst(x,fs,kaiser(256,20));  
  
clf  
mesh(t,f,(abs(s)))  
  
title('Logarithmic Chirp')  
xlabel('Time (s)')  
ylabel('Frequency (Hz)')  
view(2)
```

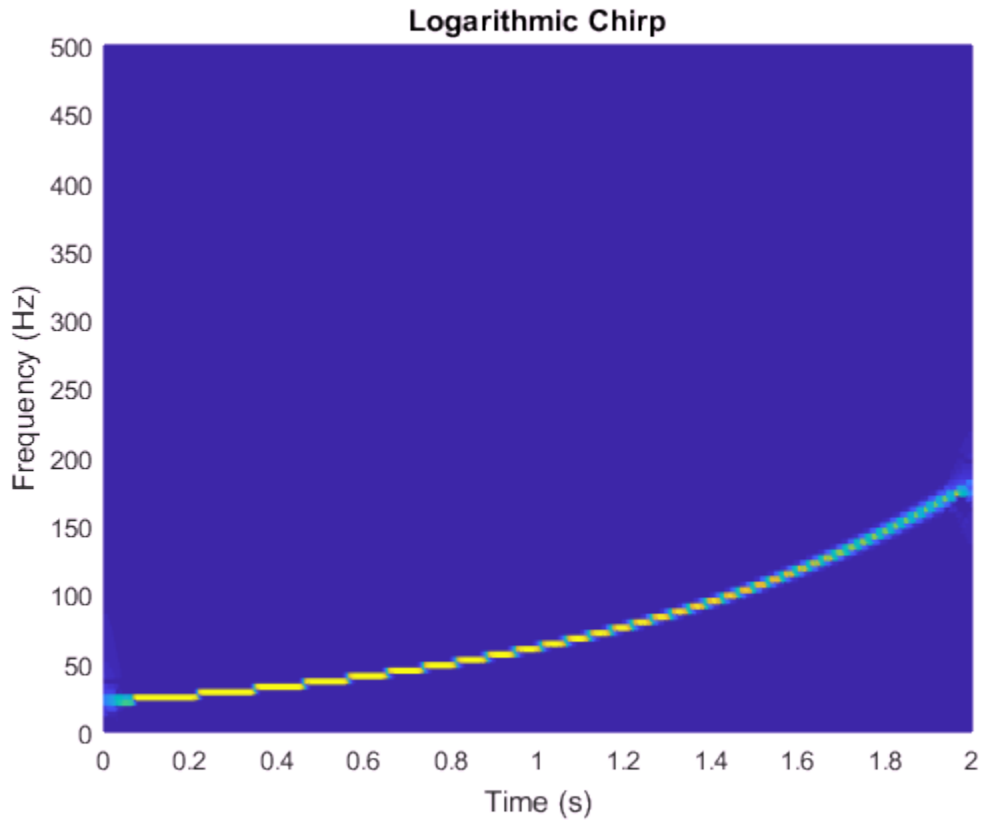

Use a logarithmic scale for the frequency axis. The transform becomes a straight line.

```
ax = gca;
```



```
ax.YScale = 'log';  
axis tight
```

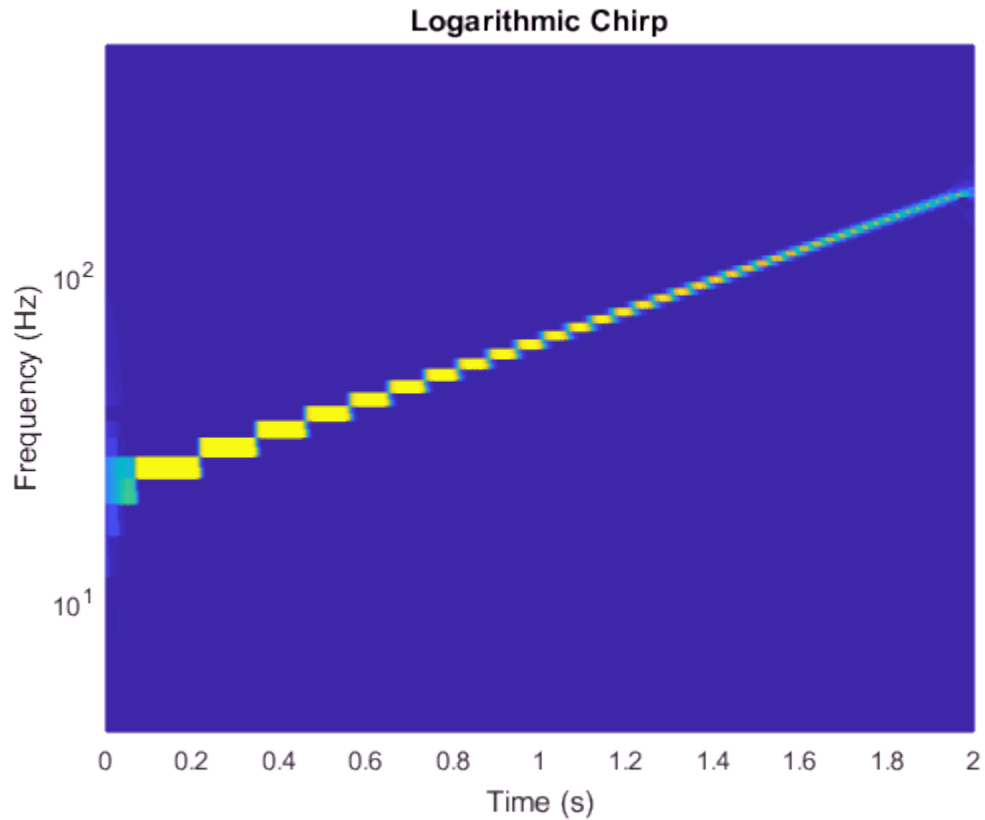

Fourier Synchrosqueezed Transform of Speech Signal

Load a speech signal sampled at $F_s = 7418$ Hz. The file contains a recording of a female voice saying the word "MATLAB®."

```
load mtlb
```

```
% To hear, type sound(mtlb,Fs)
```

Compute the synchrosqueezed transform of the signal. Use a Hann window of length 256. Display the time on the x -axis and the frequency on the y -axis.

```
fsst(mtlb,Fs,hann(256),'yaxis')
```

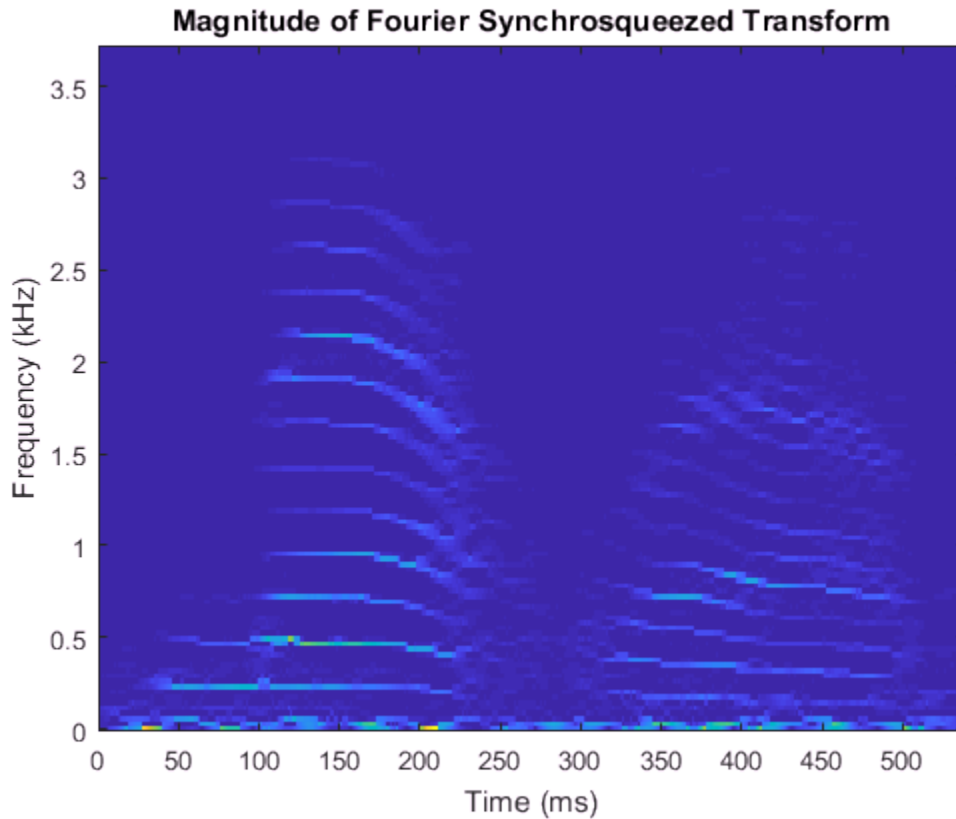

Use `ifsst` to invert the transform. Compare the original and reconstructed signals.

```
sst = fsst(mtlb,Fs,hann(256));  
xrc = ifsst(sst,hann(256));  
plot((0:length(mtlb)-1)/Fs,[mtlb xrc xrc-mtlb])  
legend('Original','Reconstructed','Difference')
```

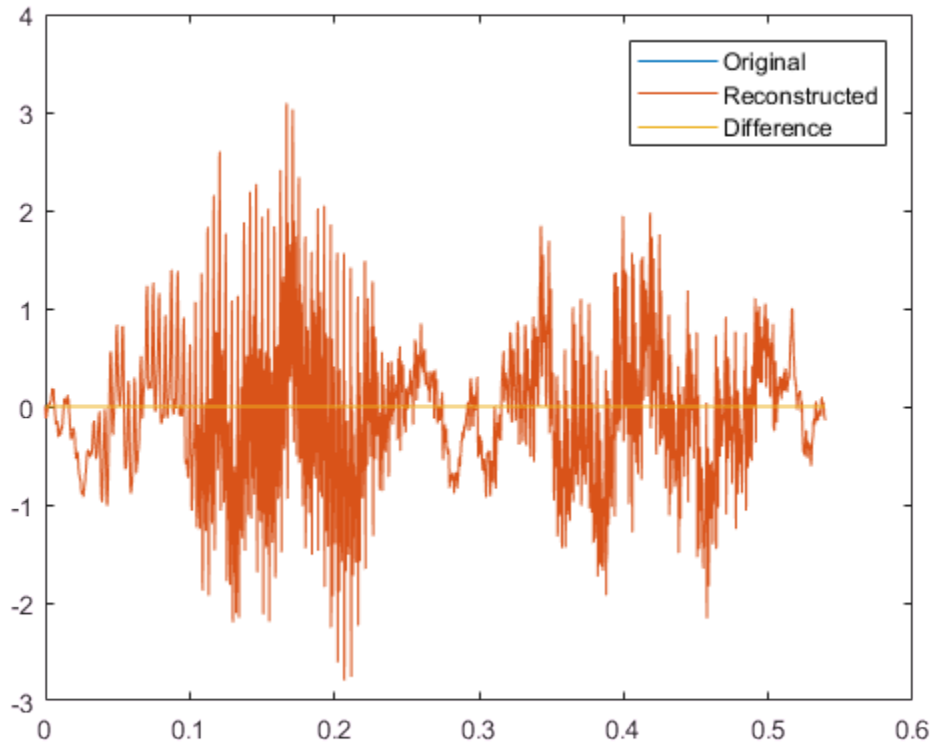

```
% To hear, type sound(xrc-mlb,Fs)
```

- “Hilbert Transform and Instantaneous Frequency”
- “Practical Introduction to Time-Frequency Analysis”

Input Arguments

x — Input signal
vector

Input signal, specified as a vector.

Example: `cos(pi/4*(0:159))+randn(1,160)` specifies a sinusoid embedded in white Gaussian noise.

Data Types: `single` | `double`

Complex Number Support: Yes

fs — Sample rate

1 Hz (default) | positive scalar

Sample rate, specified as a positive scalar. The sample rate is the number of samples per unit time. If the unit of time is seconds, then the sampling frequency is in Hz.

Data Types: `double` | `single`

ts — Sample time

`duration` scalar

Sample time, specified as a `duration` scalar. The sample time is the time elapsed between consecutive samples of `x`.

Data Types: `duration`

window — Window used to divide the signal into segments

`kaiser(256,10)` (default) | integer | vector | []

Window used to divide the signal into segments, specified as an integer or as a row or column vector.

- If `window` is an integer, then `fsst` divides `x` into segments of length `window` and windows each segment with a Kaiser window of that length and $\beta = 10$. The overlap between adjacent segments is `window - 1`.
- If `window` is a vector, then `fsst` divides `x` into segments of the same length as the vector and windows each segment using `window`. The overlap between adjacent segments is `length(window) - 1`.
- If `window` is not specified, then `fsst` divides `x` into segments of length 256 and windows each segment with a 256-sample Kaiser window with $\beta = 10$. The overlap between adjacent segments is 255. If `x` has fewer than 256 samples, then the function uses a single Kaiser window with the same length as `x` and $\beta = 10$.

For a list of available windows, see “Windows”.

Example: `hann(N+1)` and `(1-cos(2*pi*(0:N)'/N))/2` both specify a Hann window of length $N + 1$.

Data Types: `double` | `single`

freqloc — Frequency display axis

`'xaxis'` (default) | `'yaxis'`

Frequency display axis, specified as `'xaxis'` or `'yaxis'`.

- `'xaxis'` — Displays frequency on the x -axis and time on the y -axis.
- `'yaxis'` — Displays frequency on the y -axis and time on the x -axis.

This argument is ignored if you call `fsst` with output arguments.

Data Types: `char`

Output Arguments

s — Fourier synchrosqueezed transform

matrix

Fourier synchrosqueezed transform, returned as a matrix. Time increases across the columns of `s` and frequency increases down the rows of `s`, starting from zero. If `x` is real, then its synchrosqueezed spectrum is one-sided. If `x` is complex, then its synchrosqueezed spectrum is two-sided and centered.

w — Normalized frequencies

vector

Normalized frequencies, returned as a vector. The length of `w` equals the number of rows in `s`.

n — Sample numbers

vector

Sample numbers, returned as a vector. The length of `n` equals the number of columns in `s`. Each sample number in `n` is the midpoint of a windowed segment of `x`.

f — Cyclical frequencies

vector

Cyclical frequencies, returned as a vector. The length of **f** equals the number of rows in **s**.

t — Time instants

vector

Time instants, returned as a vector. The length of **t** equals the number of columns in **s**. Each time value in **t** is the midpoint of a windowed segment of **x**.

Definitions

Fourier Synchrosqueezed Transform

Many real-world signals such as speech waveforms, machine vibrations, and physiologic signals can be expressed as a superposition of amplitude-modulated and frequency-modulated modes. For time-frequency analysis, it is convenient to express such signals as sums of analytic signals through

$$f(t) = \sum_{k=1}^K f_k(t) = \sum_{k=1}^K A_k(t) e^{j2\pi\phi_k(t)}.$$

The phases $\phi_k(t)$ have time derivatives $d\phi_k(t)/dt$ that correspond to instantaneous frequencies. When the exact phases are unknown, you can use the Fourier synchrosqueezed transform to estimate them.

The Fourier synchrosqueezed transform is based on the short-time Fourier transform implemented in the `spectrogram` function. For certain kinds of nonstationary signals, the synchrosqueezed transform resembles the reassigned spectrogram because it generates sharper time-frequency estimates than the conventional transform. The `fsst` function determines the short-time Fourier transform of a function, f , using a spectral window, g , and computing

$$V_g f(t, \eta) = \int_{-\infty}^{\infty} f(x) g(x-t) e^{-j2\pi\eta(x-t)} dx.$$

Unlike the conventional definition, this definition has an extra factor of $e^{j2\pi\eta t}$. The transform values are then “squeezed” so that they concentrate around curves of

instantaneous frequency in the time-frequency plane. The resulting synchrosqueezed transform is of the form

$$T_g f(t, \omega) = \int_{-\infty}^{\infty} V_g f(t, \eta) \delta(\omega - \Omega_g f(t, \eta)) d\eta,$$

where the instantaneous frequencies are estimated with the “phase transform”

$$\Omega_g f(t, \eta) = \frac{1}{j2\pi} \frac{\frac{\partial}{\partial t} V_g f(t, \eta)}{V_g f(t, \eta)} = \eta - \frac{1}{j2\pi} \frac{V_{\partial g / \partial t} f(t, \eta)}{V_g f(t, \eta)}.$$

The transform in the denominator decreases the influence of the window. To see a simple example, refer to “Detect Closely Spaced Sinusoids”. The definition of $T_g f(t, \omega)$ differs by a factor of $1/g(0)$ from other expressions found in the literature. `fsst` incorporates the factor in the mode-reconstruction step.

Unlike the reassigned spectrogram, the synchrosqueezed transform is invertible and thus can reconstruct the individual modes that compose the signal. Invertibility imposes some constraints on the computation of the short-time Fourier transform:

- The number of DFT points is equal to the length of the specified window.
- The overlap between adjoining windowed segments is one less than the window length.
- The reassignment is performed only in frequency.

To find the modes, integrate the synchrosqueezed transform over a small frequency interval around $\Omega_g f(t, \eta)$:

$$f_k(t) \approx \frac{1}{g(0)} \int_{|\omega - \Omega_k(t)| < \varepsilon} T_g f(t, \omega) d\omega,$$

where ε is a small number.

The synchrosqueezed transform produces narrow ridges compared to the windowed short-time Fourier transform. However, the width of the short-time transform still affects the ability of the synchrosqueezed transform to separate modes. To be resolvable, the modes must obey these conditions:

- 1 For each mode, the frequency must be strictly greater than the rate of change of the

$$\text{amplitude: } \frac{d\phi_k(t)}{dt} > \frac{dA_k(t)}{dt} \quad \text{for all } k.$$

- 2 Distinct modes must be separated by at least the frequency bandwidth of the window. If the support of the window is the interval $[-\Delta, \Delta]$, then

$$\left| \frac{d\phi_k(t)}{dt} - \frac{d\phi_m(t)}{dt} \right| > 2\Delta \quad \text{for } k \neq m.$$

For an illustration, refer to “Detect Closely Spaced Sinusoids”.

References

- [1] Thakur, Gaurav, and Hau-Tieng Wu. “Synchrosqueezing-based Recovery of Instantaneous Frequency from Nonuniform Samples.” *SIAM Journal of Mathematical Analysis*. Vol.43, 2011, pp.2078–2095.
- [2] Oberlin, Thomas, Sylvain Meignen, and Valérie Perrier. “The Fourier-based Synchrosqueezing Transform.” *Proceedings of the 2014 IEEE International Conference on Acoustics, Speech, and Signal Processing (ICASSP)*, pp.315–319.
- [3] Auger, François, Patrick Flandrin, Yu-Ting Lin, Stephen McLaughlin, Sylvain Meignen, Thomas Oberlin, and Hau-Tieng Wu. “Time-Frequency Reassignment and Synchrosqueezing: An Overview.” *IEEE Signal Processing Magazine*. Vol.30, November 2013, pp.32–41.

See Also

See Also

`ifsst` | `spectrogram` | `tfridge`

Topics

“Hilbert Transform and Instantaneous Frequency”
“Practical Introduction to Time-Frequency Analysis”

Introduced in R2016b

fvtool

Open Filter Visualization Tool

Syntax

```
fvtool(b,a)
fvtool(sos)
fvtool(d)
fvtool(b1,a1,b2,a2,...,bN,aN)
fvtool(sos1,sos2,...,sosN)
fvtool(Hd)
fvtool(Hd1,Hd2,...,HdN)
h = fvtool(...)
```

Description

`fvtool(b,a)` opens FVTool and displays the magnitude response of the digital filter defined with numerator, **b** and denominator, **a**. Using FVTool you can display the phase response, group delay, impulse response, step response, pole-zero plot, and coefficients of the filter. You can export the displayed response to a file with **File > Export**.

Note: If the input to `fvtool` is single precision, the magnitude response is calculated using single-precision arithmetic.

`fvtool(sos)` opens FVTool and displays the magnitude response of the digital filter defined by the matrix of second order sections, **sos**. **sos** is a K -by-6 matrix, where the number of sections, K , must be greater than or equal to 2. If the number of sections is less than 2, `fvtool` considers the input to be a numerator vector. Each row of **sos** corresponds to the coefficients of a second order (biquad) filter. The i th row of the **sos** matrix corresponds to $[bi(1) \ bi(2) \ bi(3) \ ai(1) \ ai(2) \ ai(3)]$.

`fvtool(d)` opens FVTool and displays the magnitude response of a digital filter, **d**. Use `designfilt` to generate **d** based on frequency-response specifications.

`fvtool(b1,a1,b2,a2,...,bN,aN)` opens FVTool and displays the magnitude responses of multiple filters defined with numerators, `b1`, ..., `bN`, and denominators, `a1`, ..., `aN`.

`fvtool(sos1,sos2,...,sosN)` opens FVTool and displays the magnitude responses of multiple filters defined with second order section matrices, `sos1`, `sos2`, ..., `sosN`.

`fvtool(Hd)` opens FVTool and displays the magnitude responses for the `dfilt` filter object, `Hd`, or the array of `dfilt` filter objects.

`fvtool(Hd1,Hd2,...,HdN)` opens FVTool and displays the magnitude responses of the filters in the `dfilt` objects `Hd1`, `Hd2`, ...`HdN`.

If you have the DSP System Toolbox product installed, you can also use `fvtool(H)` and `fvtool(H1,H2,...)` to analyze:

- Quantized filter objects (`dfilt` with arithmetic set to `'single'` or `'fixed'`)
- Any of the following filter System objects.

`dsp.DigitalDownConverter` and `dsp.DigitalUpConverter` System objects support FVTool. You must pass the `'Arithmetic'` input to the FVTool when you call FVTool on these System objects.

When the input filter is a `dfilt` object, FVTool performs fixed-point analysis if the arithmetic property of the filter object is set to `'fixed'`. However, for filter System objects, `fvtool(H,'Arithmetic',ARITH,...)` analyzes `H`, based on the arithmetic specified in the `ARITH` input.

`ARITH` can be one of `'double'`, `'single'`, or `'fixed'`. The `'Arithmetic'` input is only relevant for the analysis of filter System objects. The arithmetic setting `ARITH`, applies to all the filter System objects that you input to FVTool. When you specify `'double'` or `'single'`, the function performs double- or single-precision analysis. When you specify `'fixed'`, the arithmetic changes depending on the setting of the `CoefficientDataType` property and whether the System object is locked or unlocked.

If you do not specify the arithmetic for non-CIC structures, and the System object is in an unlocked state, the function uses double-precision arithmetic. If the System object is locked, the function performs analysis based on the locked input data type. CIC structures only support fixed-point arithmetic.





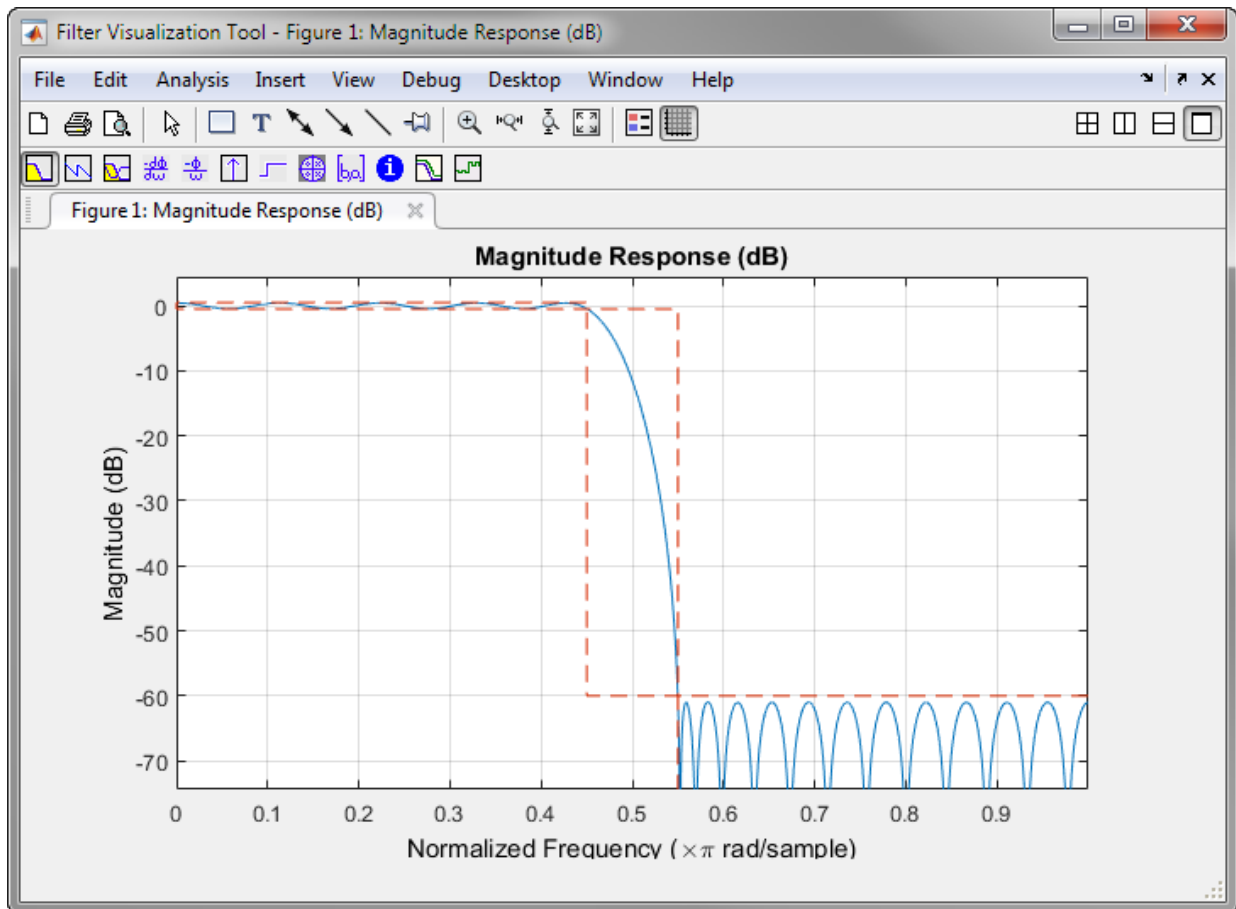

Analysis methods `noisepsd` and `freqz` have behavior restrictions in `fvtool`. To see the rules, click the links to these methods.

`h = fvtool(...)` returns a figure handle `h`. You can use this handle to interact with FVTool from the command line. See “Controlling FVTool from the MATLAB Command Line” on page 1-1002.













FVTool has two toolbars.

- An extended version of the MATLAB plot editing (MATLAB) toolbar. The following table shows the toolbar icons specific to FVTool.



Icon	Description
	Restore default view. This view displays buffer regions around the data and shows only significant data. To see the response using standard MATLAB plotting, which shows all data values, use View > Full View .
	Toggle legend
	Toggle grid
	Link to Filter Designer (appears only if FVTool was started from Filter Designer)
 	Toggle Add mode/Replace mode (appears only if FVTool was launched from Filter Designer)



- Analysis toolbar with the following icons



	Magnitude response of the current filter. See <code>freqz</code> and <code>zerophase</code> for more information. To see the zero-phase response, right-click the y-axis label of the Magnitude plot and select Zero-phase from the context menu.
	Phase response of the current filter. See <code>phasez</code> for more information.
	Superimposes the magnitude response and the phase response of the current filter. See <code>freqz</code> for more information.
	Shows the group delay of the current filter. Group delay is the average delay of the filter as a function of frequency. See <code>grpdelay</code> for more information.
	Shows the phase delay of the current filter. Phase delay is the time delay the filter imposes on each component of the input signal. See <code>phasedelay</code> for more information.
	Impulse response of the current filter. The impulse response is the response of the filter to a impulse input. See <code>impz</code> for more information.
	Step response of the current filter. The step response is the response of the filter to a step input. See <code>stepz</code> for more information.

	Pole-zero plot, which shows the pole and zero locations of the current filter on the z -plane. See <code>zplane</code> for more information.
	Filter coefficients of the current filter, which depend on the filter structure (e.g., direct-form, lattice, etc.) in a text box. For SOS filters, each section is displayed as a separate filter.
	Detailed filter information.

Linking to Filter Designer

In the Filter Designer app, selecting **View > Filter Visualization Tool** or the **Full View Analysis** toolbar button  when an analysis is displayed starts FVTool for the current filter. You can synchronize Filter Designer and FVTool with the toolbar button . Any changes made to the filter in Filter Designer are immediately reflected in FVTool.

Two link modes are provided via the toggle toolbar button  / .

- Replace  — removes the filter currently displayed in FVTool and inserts the new filter.
- Add  — retains the filter currently displayed in FVTool and adds the new filter to the display.

Modifying the Axes

You can change the x - or y -axis units by right-clicking the mouse on the axis label or by right-clicking on the plot and selecting **Analysis Parameters**. Available options for the axes units are as follows.

Plot	X-Axis Units	Y-Axis Units
Magnitude	Normalized Frequency Linear Frequency	Magnitude Magnitude (dB) Magnitude squared Zero-Phase
Phase	Normalized Frequency Linear Frequency	Phase Continuous Phase Degrees

Plot	X-Axis Units	Y-Axis Units
		Radians
Magnitude and Phase	Normalized Frequency Linear Frequency	(y-axis on left side) Magnitude Magnitude (dB) Magnitude squared Zero-Phase (y-axis on right side) Phase Continuous Phase Degrees Radians
Group Delay	Normalized Frequency Linear Frequency	Samples Time
Phase Delay	Normalized Frequency Linear Frequency	Degrees Radians
Impulse Response	Samples Time	Amplitude
Step Response	Samples Time	Amplitude
Pole-Zero	Real Part	Imaginary Part

Modifying the Plot

You can use any of the plot editing toolbar buttons to change the properties of your plot.

Analysis Parameters are parameters that apply to the displayed analyses. To display them, right-click in the plot area and select **Analysis Parameters** from the menu. (Note that you can access the menu only if the **Edit Plot** button is inactive.) The following analysis parameters are displayed. (If more than one response is displayed, parameters applicable to each plot are displayed.) Not all of these analysis fields are displayed for all types of plots:

- **Normalized Frequency** — if checked, frequency is normalized between 0 and 1, or if not checked, frequency is in Hz
- **Frequency Scale** — *y*-axis scale (Linear or Log)

- **Frequency Range** — range of the frequency axis or Specify freq. vector
- **Number of Points** — number of samples used to compute the response
- **Frequency Vector** — vector to use for plotting, if Specify freq. vector is selected in **Frequency Range**.
- **Magnitude Display** — *y*-axis units (Magnitude, Magnitude (dB), Magnitude squared, or Zero-Phase)
- **Phase Units** — *y*-axis units (Degrees or Radians)
- **Phase Display** — type of phase plot (Phase or Continuous Phase)
- **Group Delay Units** — *y*-axis units (Samples or Time)
- **Specify Length** — length type of impulse or step response (Default or Specified)
- **Length** — number of points to use for the impulse or step response

In addition to the above analysis parameters, you can change the plot type for Impulse and Step Response plots by right-clicking and selecting **Line with Marker**, **Stem** or **Line** from the context menu. You can change the *x*-axis units by right-clicking the *x*-axis label and selecting **Samples** or **Time**.

To save the displayed parameters as the default values to use when Filter Designer or FVTool is opened, click **Save as default**.

To restore the default values, click **Restore original defaults**.

Data tips display information about a particular point in the plot. See “Display Data Values Interactively” (MATLAB) for information on data tips.

If you have the DSP System Toolbox software, FVTool displays a specification mask along with your designed filter on a magnitude plot.

Note To use **View > Passband zoom**, your filter must have been designed using `fdesign` or Filter Designer. Passband zoom is not provided for cascaded integrator-comb (CIC) filters because CICs do not have conventional passbands.

Overlaying a Response

You can overlay a second response on the plot by selecting **Analysis > Overlay Analysis** and selecting an available response. A second *y*-axis is added to the right side of the response plot. The Analysis Parameters dialog box shows parameters for the *x*-

axis and both y-axes. See “Display Analysis Parameters” on page 1-1005 for a sample Analysis Parameters dialog box.

Controlling FVTool from the MATLAB Command Line

After you obtain the handle for FVTool, you can control some aspects of FVTool from the command line. In addition to the standard Handle Graphics[®] properties (see Handle Graphics in the MATLAB documentation), FVTool has the following properties:

- 'Analysis' — displays the specified type of analysis plot. The following table lists all analysis types and how to invoke them. Note that the only analyses that use filter internals are magnitude response estimate and round-off noise power, which are available only with the DSP System Toolbox product.

Analysis Type	Analysis Option
Magnitude plot	'magnitude'
Phase plot	'phase'
Magnitude and phase plot	'freq'
Group delay plot	'grpdelay'
Phase delay plot	'phasedelay'
Impulse response plot	'impulse'
Step response plot	'step'
Pole-zero plot	'polezero'
Filter coefficients	'coefficients'
Filter information	'info'
Magnitude response estimate (available only with the DSP System Toolbox product, see <code>freqrespest</code> for more information)	'magestimate'
Round-off noise power (available only with the DSP System Toolbox product, see <code>noisepsd</code> for more information)	'noisepower'

- 'Grid' — controls whether the grid is 'on' or 'off'
- 'Legend' — controls whether the legend is 'on' or 'off'
- 'Fs' — controls the sampling frequency of filters in FVTool. The sampling frequency vector must be of the same length as the number of filters or a scalar value. If it is a vector, each value is applied to its corresponding filter. If it is a scalar, the same value is applied to all filters.
- `SosViewSettings` — (This option is available only if you have the DSP System Toolbox product.) For second-order sections filters, this controls how the filter is displayed. The `SOSViewSettings` property contains an object so you must use this syntax to set it: `set(h.SOSViewSettings, 'View', viewtype)`, where *viewtype* is one of the following:
 - 'Complete' — Displays the complete response of the overall filter
 - 'Individual' — Displays the response of each section separately
 - 'Cumulative' — Displays the response for each section accumulated with each prior section. If your filter has three sections, the first plot shows section one, the second plot shows the accumulation of sections one and two, and the third plot show the accumulation of all three sections.

You can also define whether to use `SecondaryScaling`, which determines where the sections should be split. The secondary scaling points are the scaling locations between the recursive and the nonrecursive parts of the section. The default value is `false`, which does not use secondary scaling. To turn on secondary scaling, use this syntax: `set(h.SOSViewSettings, 'View', 'Cumulative', true)`

- 'UserDefined' — Allows you to define which sections to display and the order in which to display them. Enter a cell array where each section is represented by its index. If you enter one index, only that section is plotted. If you enter a range of indices, the combined response of that range of sections is plotted. For example, if your filter has four sections, entering `{1:4}` plots the combined response for all four sections, and entering `{1,2,3,4}` plots the response for each section individually.

Note You can change other properties of FVTool from the command line using the `set` function. Use `get(h)` to view property tags and current property settings.

You can use the following methods with the FVTool handle.

`addfilter(h, filtobj)` adds a new filter to FVTool. The new filter, `filtobj`, must be a `dfilt` filter object. You can specify the sampling frequency of the new filter with `addfilter(h, filtobj, 'Fs', 10)`.

`setfilter(h, filtobj)` replaces the filter in FVTool with the filter specified in `filtobj`. You can set the sampling frequency as described above.

`deletefilter(h, index)` deletes the filter at the FVTool cell array `index` location.

`legend(h, str1, str2, ...)` creates a legend in FVTool by associating `str1` with filter 1, `str2` with filter 2, etc. See `legend` in the MATLAB documentation for information.

Examples

Magnitude Response of Elliptic Filter

Display the magnitude response of a 6th-order elliptic filter. Specify a passband ripple of 3 dB, a stopband attenuation of 50 dB, a sample rate of 1 kHz, and a normalized passband edge of 300 Hz. Start FVTool from the command line.

```
[b,a] = ellip(6,3,50,300/500);  
fvtool(b,a)
```

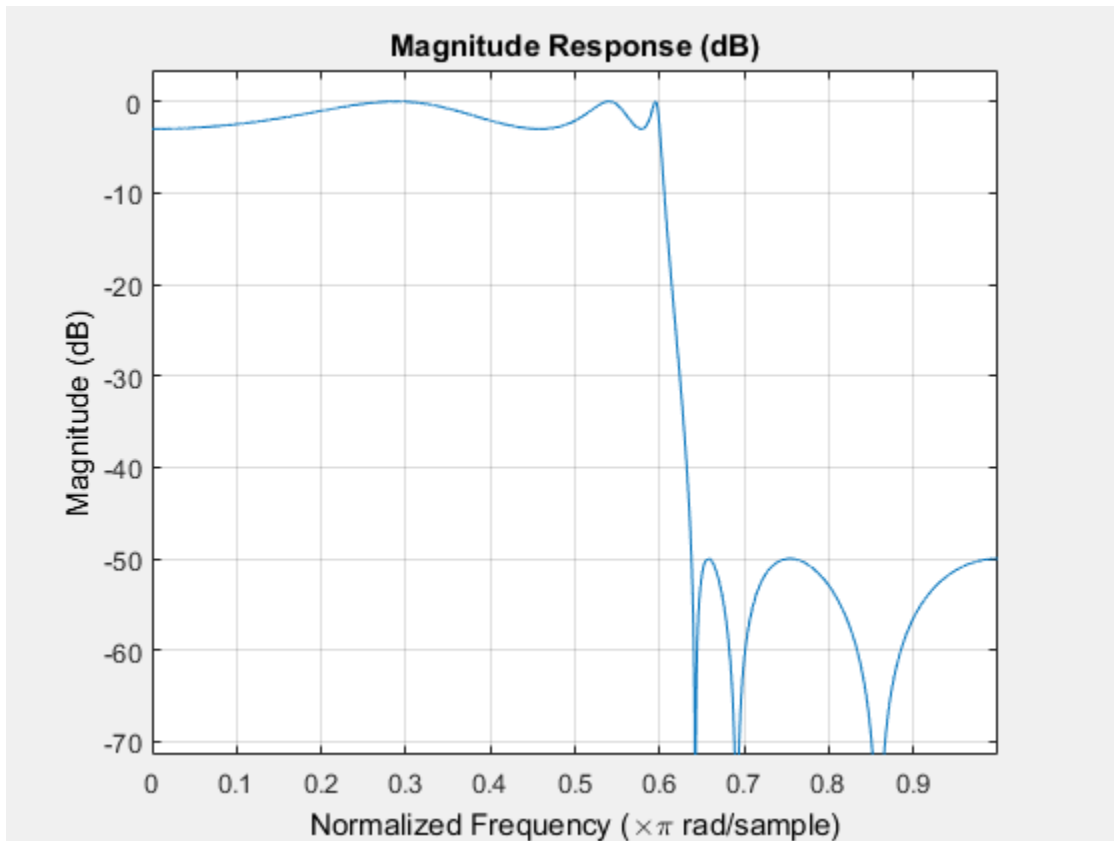

Display Analysis Parameters

Display and analyze multiple FIR filters, starting FVTool from the command line.

```
b1 = firpm(20,[0 0.4 0.5 1],[1 1 0 0]);  
b2 = firpm(40,[0 0.4 0.5 1],[1 1 0 0]);  
fvtool(b1,1,b2,1)
```

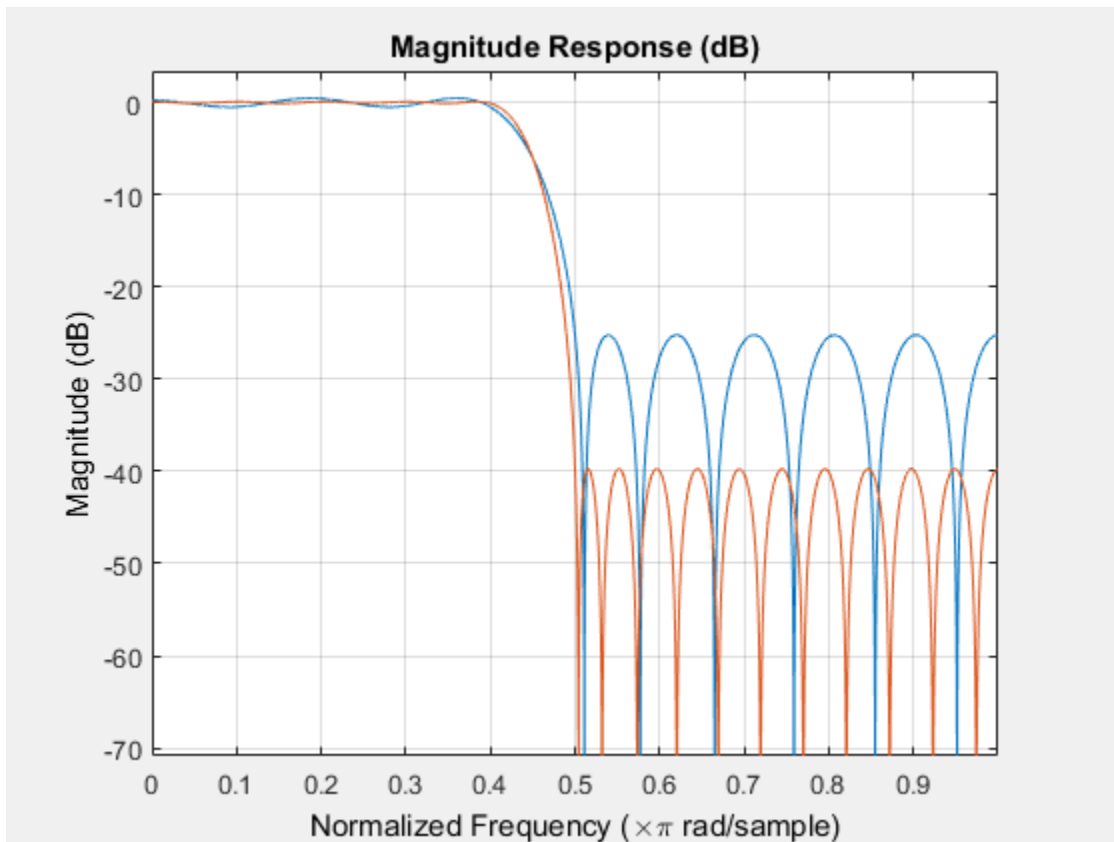

Display the associated analysis parameters.

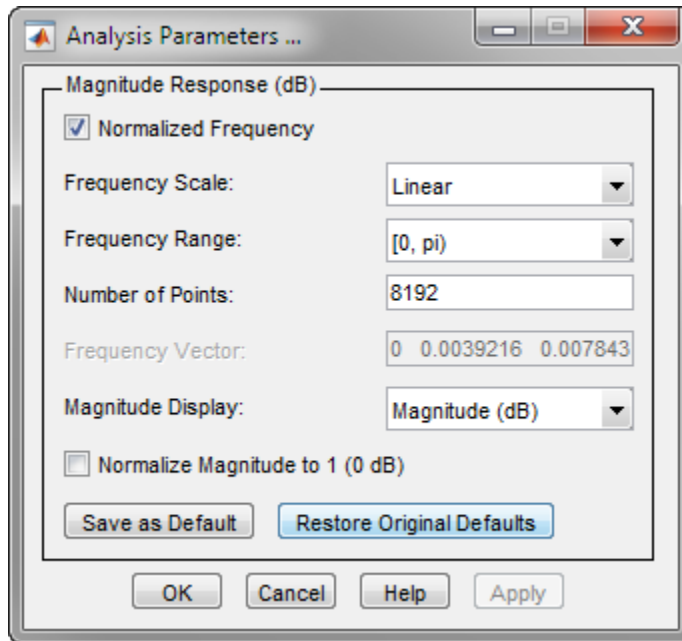

FVTool Figure Handle Commands

Start FVTool from the command line. Display the magnitude response of a 6th-order elliptic filter. Specify a passband ripple of 3 dB, a stopband attenuation of 50 dB, a sample rate of 1 kHz, and a normalized passband edge of 300 Hz.

```
[b,a] = ellip(6,3,50,300/500);  
h = fvtool(b,a);
```

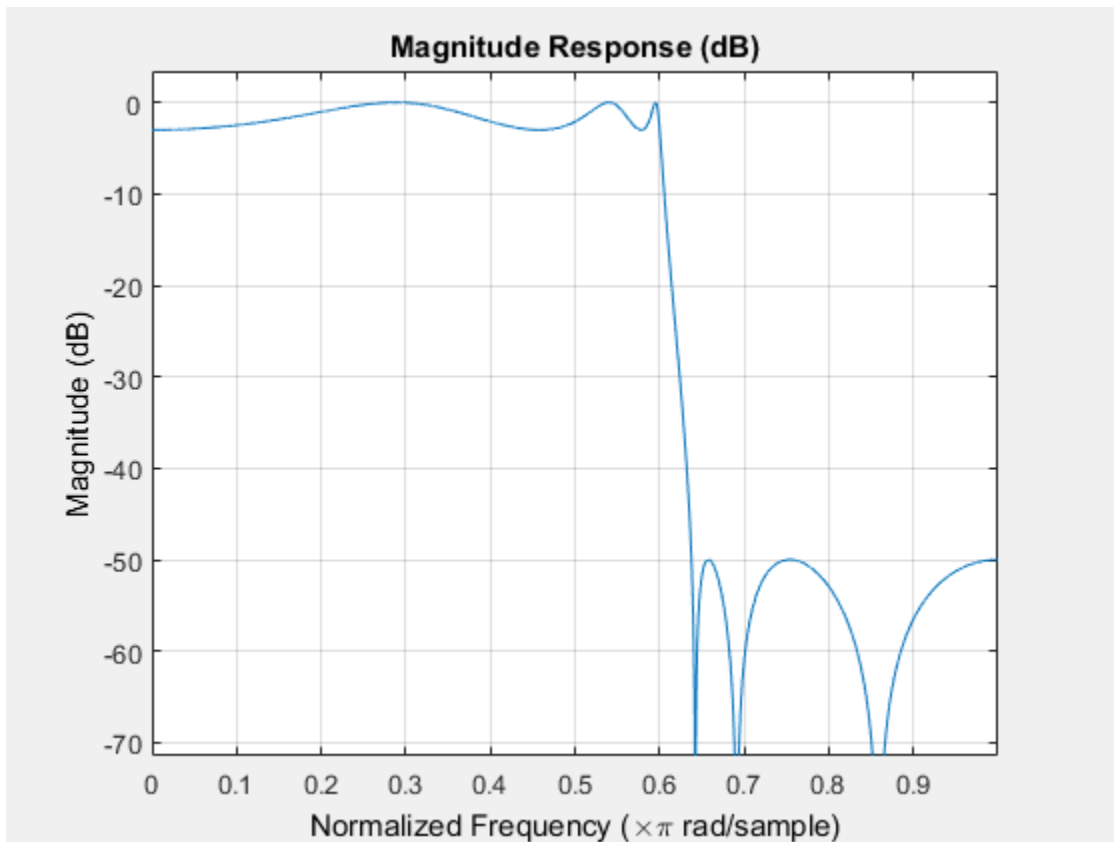

Display the phase response of the filter.

```
h.Analysis = 'phase';
```

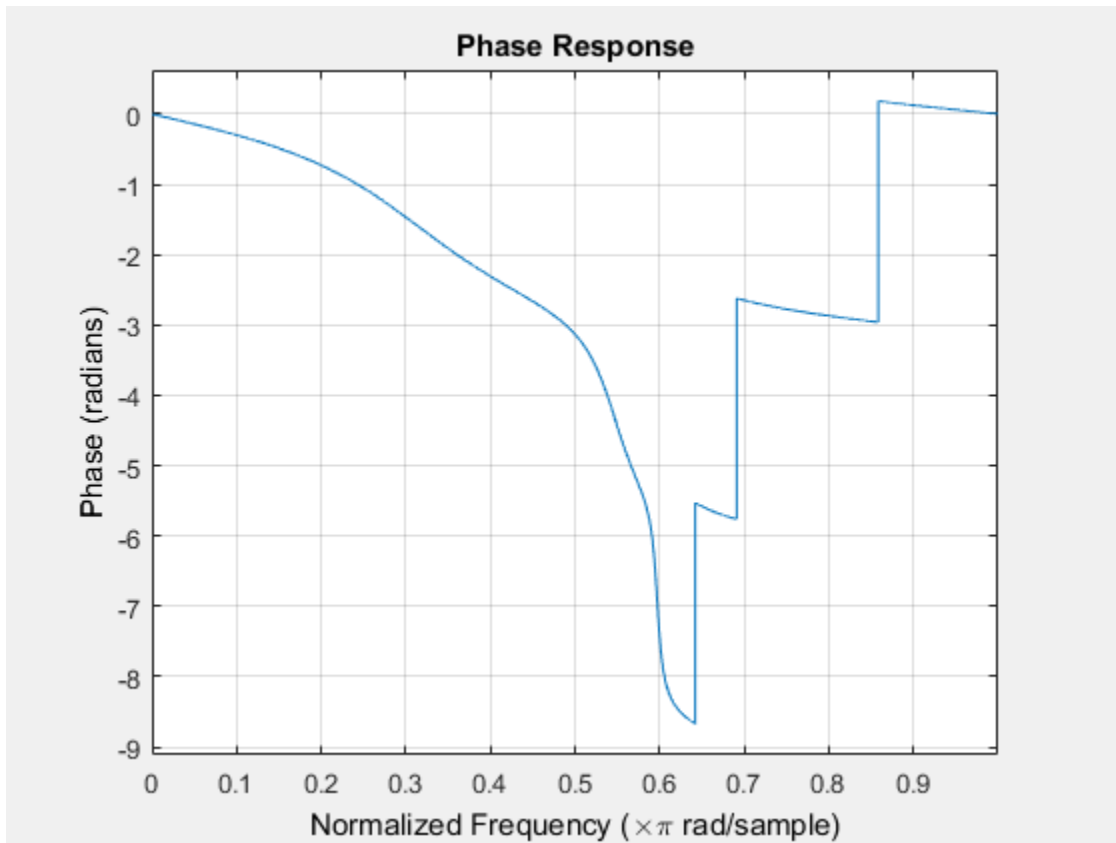

Turn on the plot legend and add text.

```
legend(h, 'Phase plot')
```

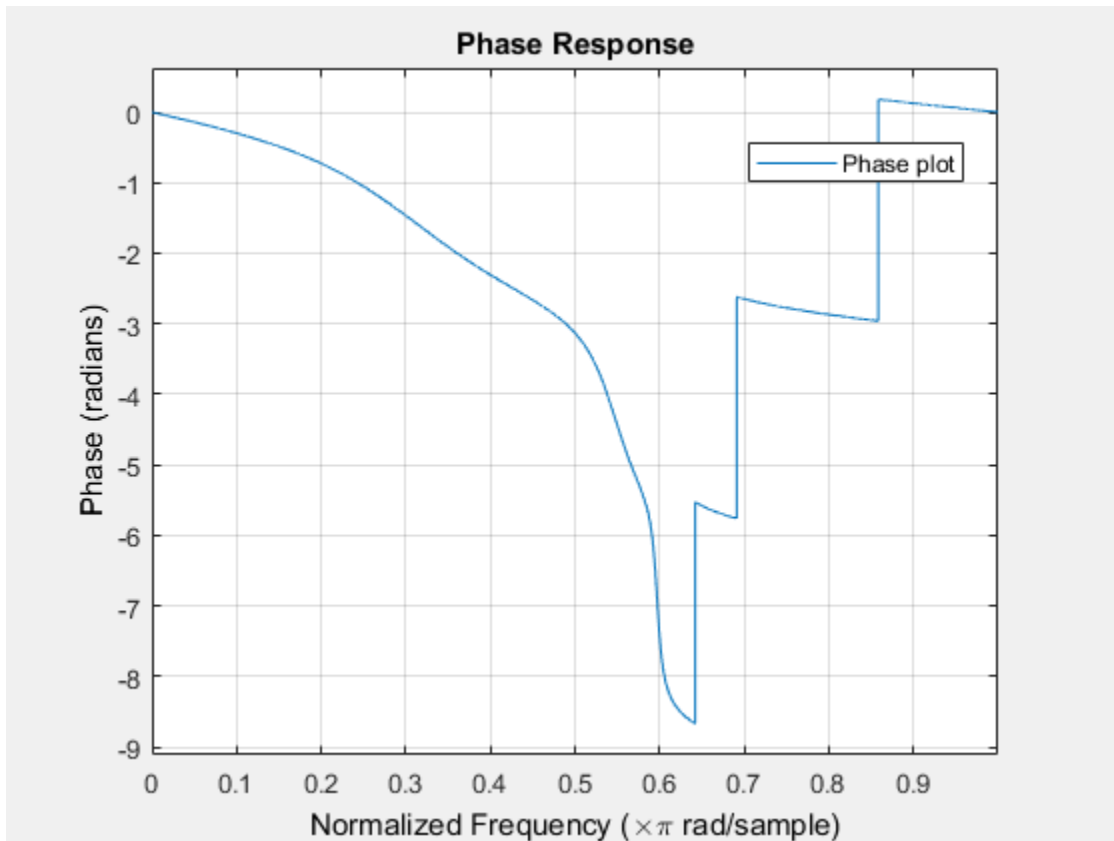

Specify a sample rate of 1 kHz. Display the two-sided centered response.

```
h.Fs = 1000;
h.FrequencyRange='[-Fs/2, Fs/2]';
```

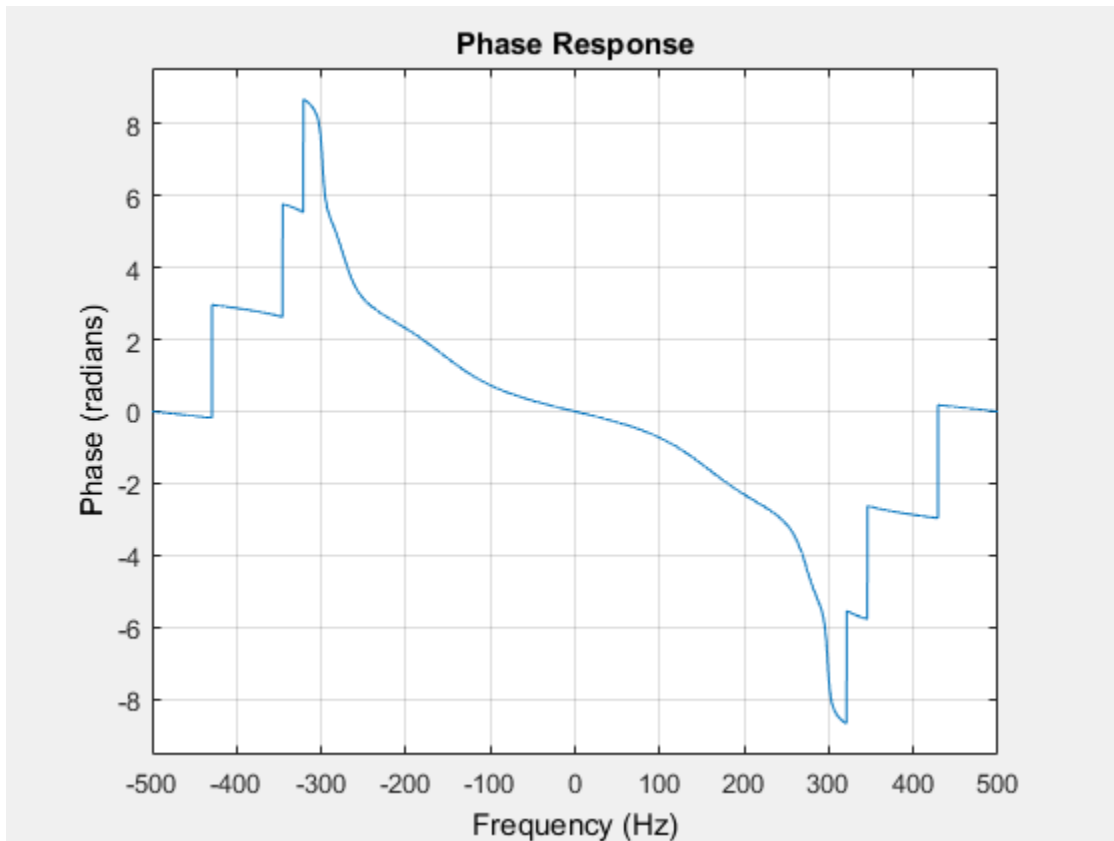
View the all the properties of the plot. The properties specific to FVTool are at the end of the list.

`get(h)`

```
Grid: 'on'  
Legend: 'Off'  
AnalysisToolbar: 'on'  
FigureToolbar: 'on'  
DesignMask: 'off'  
SOSViewSettings: [1x1 dspopts.sosview]  
Fs: 1000  
Alphamap: [1x64 double]  
CloseRequestFcn: 'closereq'
```

```
        Color: [0.9400 0.9400 0.9400]
        Colormap: [64×3 double]
        CurrentAxes: [1×1 Axes]
CurrentCharacter: ''
CurrentObject: [0×0 GraphicsPlaceholder]
CurrentPoint: [0 0]
DockControls: 'on'
    FileName: ''
IntegerHandle: 'on'
InvertHardcopy: 'on'
    KeyPressFcn: ''
    KeyReleaseFcn: ''
        MenuBar: 'none'
            Name: 'Filter Visualization Tool - Phase Response'
        NextPlot: 'new'
    NumberTitle: 'on'
    PaperUnits: 'inches'
PaperOrientation: 'portrait'
    PaperPosition: [1.3333 3.3125 5.8333 4.3750]
PaperPositionMode: 'auto'
    PaperSize: [8.5000 11]
    PaperType: 'usletter'
    Pointer: 'arrow'
    PointerShapeCData: [16×16 double]
PointerShapeHotSpot: [1 1]
    Position: [361 292 560 420]
    Renderer: 'opengl'
    RendererMode: 'auto'
    Resize: 'on'
    ResizeFcn: ''
    SelectionType: 'normal'
        ToolBar: 'auto'
        Type: 'figure'
        Units: 'pixels'
WindowButtonDownFcn: ''
WindowButtonMotionFcn: ''
    WindowButtonUpFcn: ''
    WindowKeyPressFcn: ''
    WindowKeyReleaseFcn: ''
WindowScrollWheelFcn: ''
    WindowStyle: 'normal'
    BeingDeleted: 'off'
    ButtonDownFcn: ''
    Children: [15×1 Graphics]
```

```

        Clipping: 'on'
        CreateFcn: ''
        DeleteFcn: ''
        BusyAction: 'queue'
    HandleVisibility: 'on'
        HitTest: 'on'
    Interruptible: 'on'
        Parent: [1×1 Root]
        Selected: 'off'
    SelectionHighlight: 'on'
        Tag: 'filtervisualizationtool'
    UIContextMenu: [0×0 GraphicsPlaceholder]
        UserData: []
        Visible: 'on'
    OverlaidAnalysis: ''
        Analysis: 'phase'
    NormalizedFrequency: 'off'
        PhaseUnits: 'Radians'
        FrequencyScale: 'Linear'
        PhaseDisplay: 'Phase'
        PolyphaseView: 'off'
    FrequencyVector: [1×256 double]
    NumberOfPoints: 8192
    FrequencyRange: '[-Fs/2, Fs/2]'
    ShowReference: 'on'

```

- “Filter Analysis using FVTool”

See Also

See Also

Apps

Filter Designer

Functions

digitalFilter | designfilt | sptool

Topics

“Filter Analysis using FVTool”

Introduced before R2006a

fwht

Fast Walsh-Hadamard transform

Syntax

```
y = fwht(x)
y = fwht(x,n)
y = fwht(x,n,ordering)
```

Description

`y = fwht(x)` returns the coefficients of the discrete Walsh-Hadamard transform of the input `x`. If `x` is a matrix, the FWHT is calculated on each column of `x`. The FWHT operates only on signals with length equal to a power of 2. If the length of `x` is less than a power of 2, its length is padded with zeros to the next greater power of two before processing.

`y = fwht(x,n)` returns the `n`-point discrete Walsh-Hadamard transform, where `n` must be a power of 2. `x` and `n` must be the same length. If `x` is longer than `n`, `x` is truncated; if `x` is shorter than `n`, `x` is padded with zeros.

`y = fwht(x,n,ordering)` specifies the ordering to use for the returned Walsh-Hadamard transform coefficients. To specify the ordering, you must enter a value for the length `n` or, to use the default behavior, specify an empty vector (`[]`) for `n`. Valid values for the ordering are the following:

Ordering	Description
'sequency'	Coefficients in order of increasing sequency value, where each row has an additional zero crossing. This is the default ordering.
'hadamard'	Coefficients in normal Hadamard order.
'dyadic'	Coefficients in Gray code order, where a single bit change occurs from one coefficient to the next.

For more information on the Walsh functions and ordering, see “Walsh-Hadamard Transform”.

Examples

Walsh-Hadamard Transform of a Signal

This example shows a simple input signal and its Walsh-Hadamard transform.

```
x = [19 -1 11 -9 -7 13 -15 5];
y = fwht(x)
```

```
y =
```

```
      2      3      0      4      0      0      10      0
```

y contains nonzero values at locations 0, 1, 3, and 6. Form the Walsh functions with the sequency values 0, 1, 3, and 6 to recreate x.

```
w0 = [1 1 1 1 1 1 1 1];
w1 = [1 1 1 1 -1 -1 -1 -1];
w3 = [1 1 -1 -1 1 1 -1 -1];
w6 = [1 -1 1 -1 -1 1 -1 1];
w = y(0+1)*w0 + y(1+1)*w1 + y(3+1)*w3 + y(6+1)*w6
```

```
w =
```

```
      19      -1      11      -9      -7      13      -15      5
```

Algorithms

The fast Walsh-Hadamard transform algorithm is similar to the Cooley-Tukey algorithm used for the FFT. Both use a butterfly structure to determine the transform coefficients. See the references for details.

References

- [1] Beauchamp, Kenneth G. *Applications of Walsh and Related Functions: With an Introduction to Sequency Theory*. London: Academic Press, 1984.

[2] Beer, Tom. "Walsh Transforms." *American Journal of Physics*. Vol. 49, 1981, pp.466–472.

See Also

ifwht | dct | idct | fft | ifft

Introduced in R2008b

gauspuls

Gaussian-modulated sinusoidal pulse

Syntax

```
yi = gauspuls(t,fc,bw)
yi = gauspuls(t,fc,bw,bwr)
[yi,yq] = gauspuls(...)
[yi,yq,ye] = gauspuls(...)
tc = gauspuls('cutoff',fc,bw,bwr,tpe)
```

Description

`gauspuls` generates Gaussian-modulated sinusoidal pulses.

`yi = gauspuls(t,fc,bw)` returns a unity-amplitude Gaussian RF pulse at the times indicated in array `t`, with a center frequency `fc` in hertz and a fractional bandwidth `bw`, which must be greater than 0. The default value for `fc` is 1000 Hz and for `bw` is 0.5.

`yi = gauspuls(t,fc,bw,bwr)` returns a unity-amplitude Gaussian RF pulse with a fractional bandwidth of `bw` as measured at a level of `bwr` dB with respect to the normalized signal peak. The fractional bandwidth reference level `bwr` must be less than 0, because it indicates a reference level less than the peak (unity) envelope amplitude. The default value for `bwr` is -6 dB. Note that the fractional bandwidth is specified in terms of power ratios. This corresponds to the -3 dB point expressed in magnitude ratios.

`[yi,yq] = gauspuls(...)` returns both the in-phase and quadrature pulses.

`[yi,yq,ye] = gauspuls(...)` returns the RF signal envelope.

`tc = gauspuls('cutoff',fc,bw,bwr,tpe)` returns the cutoff time `tc` (greater than or equal to 0) at which the trailing pulse envelope falls below `tpe` dB with respect to the peak envelope amplitude. The trailing pulse envelope level `tpe` must be less than 0, because it indicates a reference level less than the peak (unity) envelope amplitude. The default value for `tpe` is -60 dB.

Examples

Generate a Gaussian RF Pulse

Plot a 50 kHz Gaussian RF pulse with 60% bandwidth, sampled at a rate of 1 MHz. Truncate the pulse where the envelope falls 40 dB below the peak.

```
tc = gauspuls('cutoff',50e3,0.6,[],-40);  
t = -tc : 1e-6 : tc;  
yi = gauspuls(t,50e3,0.6);  
plot(t,yi)
```

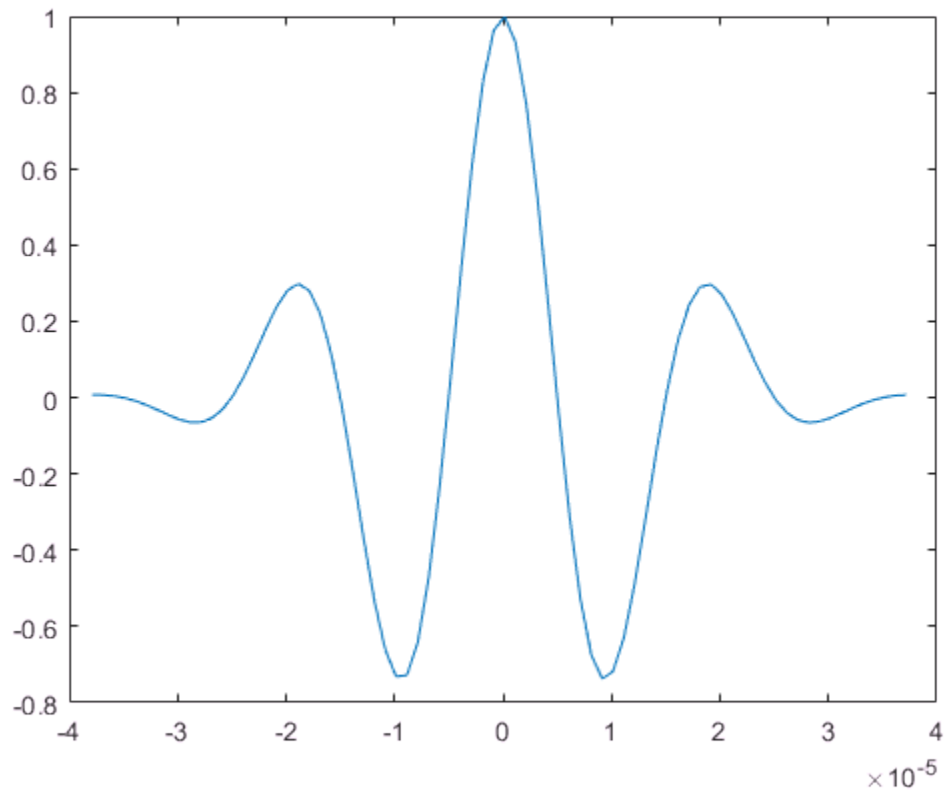

Tips

Default values are substituted for empty or omitted trailing input arguments.

See Also

chirp | cos | diric | pulstran | rectpuls | sawtooth | sin | sinc | square |
tripuls

Introduced before R2006a

gaussdesign

Gaussian FIR pulse-shaping filter design

Syntax

```
h = gaussdesign(bt,span,sps)
```

Description

`h = gaussdesign(bt,span,sps)` designs a lowpass FIR Gaussian pulse-shaping filter and returns a vector, `h`, of filter coefficients. The filter is truncated to `span` symbols, and each symbol period contains `sps` samples. The order of the filter, `sps*span`, must be even.

Examples

Gaussian Filter for a GSM GMSK Digital Cellular Communication System

Specify that the modulation used to transmit the bits is a Gaussian minimum-shift keying (GMSK) pulse. This pulse has a 3-dB bandwidth equal to 0.3 of the bit rate. Truncate the filter to 4 symbols and represent each symbol with 8 samples.

```
bt = 0.3;  
span = 4;  
sps = 8;  
h = gaussdesign(bt,span,sps);  
fvtool(h,'impulse')
```

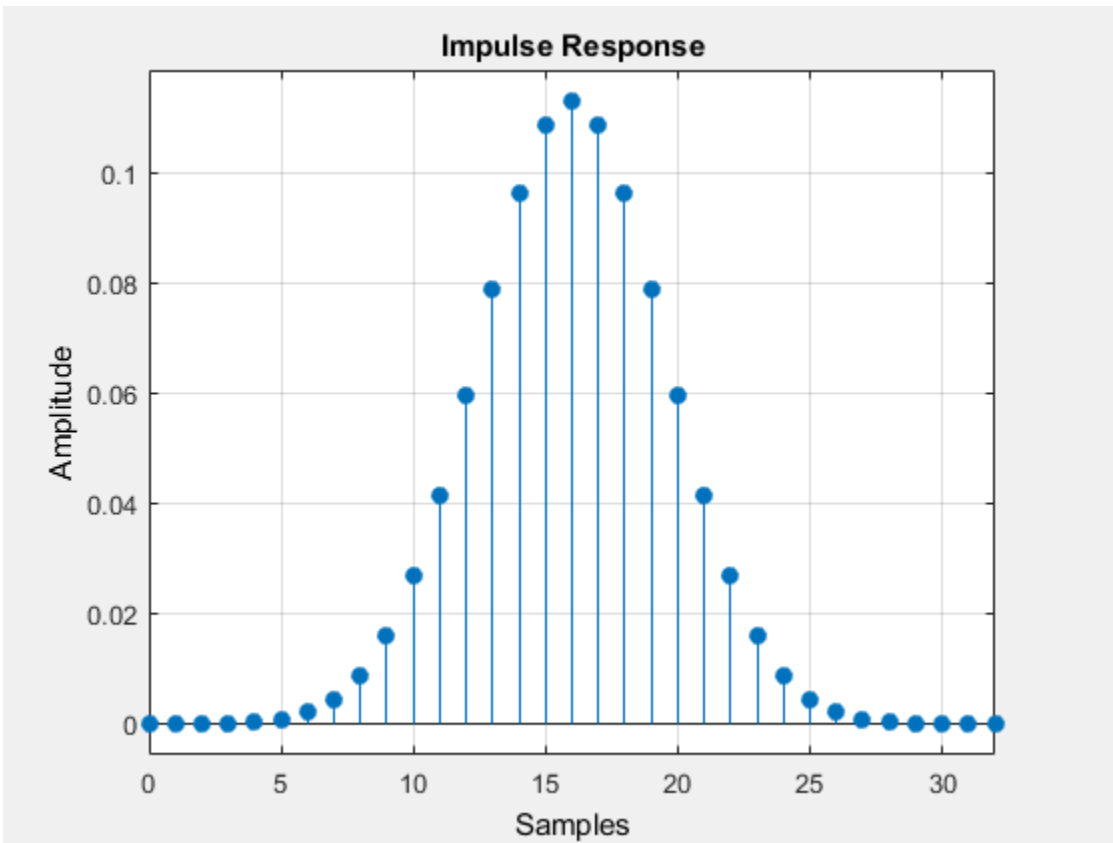

Input Arguments

bt — 3-dB bandwidth-symbol time product

positive real scalar

Product of the 3-dB one-sided bandwidth, in hertz, and the symbol time, in seconds. Specify this value as a positive real scalar. Smaller values of `bt` produce larger pulse widths.

Data Types: `double` | `single`

span — Number of symbols

3 (default) | positive integer scalar

Number of symbols, specified as a positive integer scalar.

Data Types: double | single

sps — Samples per symbol

2 (default) | positive integer scalar

Number of samples per symbol period (oversampling factor), specified as a positive integer scalar.

Data Types: double | single

Output Arguments

h — FIR filter coefficients

row vector

FIR coefficients of the Gaussian pulse-shaping filter, returned as a row vector. The coefficients are normalized so that the nominal passband gain is always 1.

Data Types: double | single

References

- [1] Rappaport, Theodore S. *Wireless Communications: Principles and Practice*. 2nd Ed. Upper Saddle River, NJ: Prentice Hall, 2002.
- [2] Krishnapura, N., S. Pavan, C. Mathiazhagan, and B. Ramamurthi. "A baseband pulse shaping filter for Gaussian minimum shift keying." *Proceedings of the 1998 IEEE International Symposium on Circuits and Systems*. Vol. 1, 1998, pp. 249–252.

See Also

See Also

rcosdesign

Introduced in R2013b

gausswin

Gaussian window

Syntax

```
w = gausswin(N)
w = gausswin(N,Alpha)
```

Description

`w = gausswin(N)` returns an N-point Gaussian window in a column vector, `w`. `N` is a positive integer.

`w = gausswin(N,Alpha)` returns an N-point Gaussian window with `Alpha` proportional to the reciprocal of the standard deviation. The width of the window is inversely related to the value of α . A larger value of α produces a narrower window. The value of α defaults to 2.5.

Note If the window appears to be clipped, increase `N`, the number of points.

Examples

Gaussian Window

Create a 64-point Gaussian window. Display the result in `wvtool`.

```
L = 64;
wvtool(gausswin(L))
```

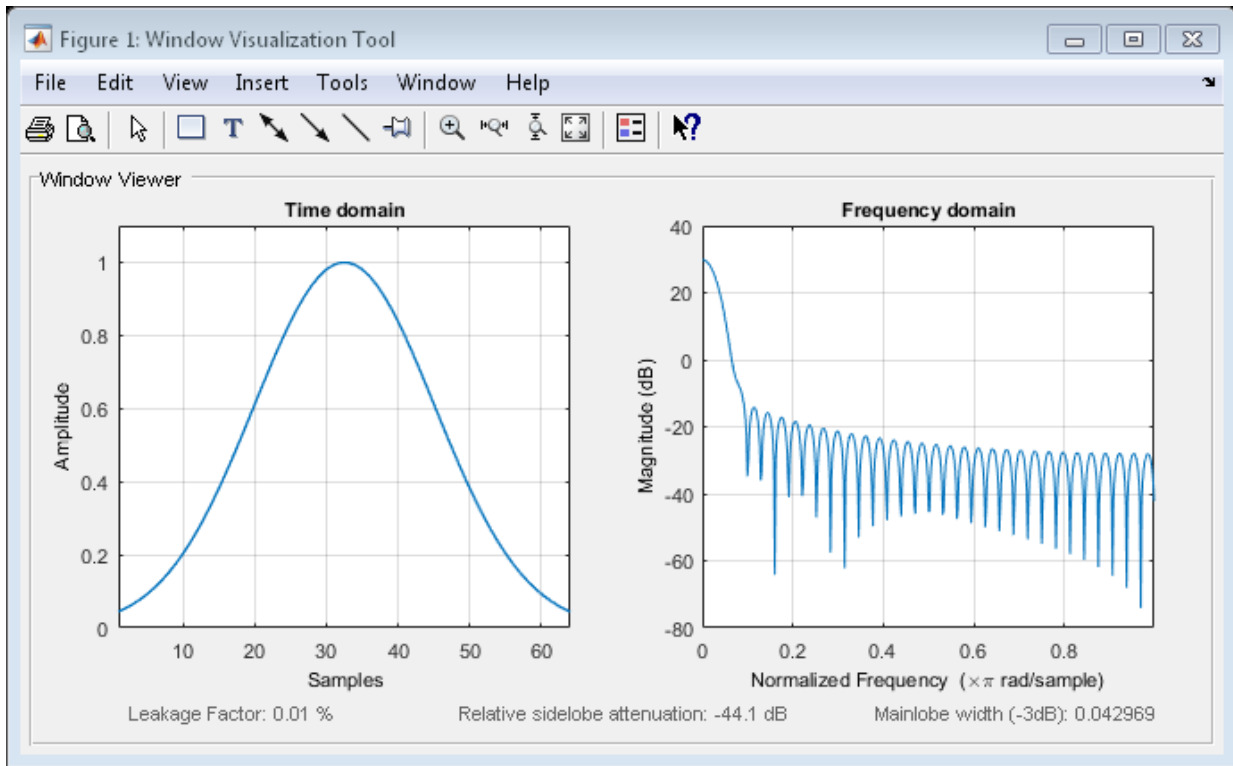

Gaussian Window and the Fourier Transform

This example shows that the Fourier transform of the Gaussian window is also Gaussian with a reciprocal standard deviation. This is an illustration of the time-frequency uncertainty principle.

Create a Gaussian window of length 64 by using `gausswin` and the defining equation.

Set $\alpha = 8$, which results in a standard deviation of $64/16 = 4$. Accordingly, you expect that the Gaussian is essentially limited to the mean plus or minus 3 standard deviations, or an approximate support of $[-12, 12]$.

```
N = 64;
n = -(N-1)/2:(N-1)/2;
alpha = 8;
```



```
w = gausswin(N,alpha);  
  
stdev = (N-1)/(2*alpha);  
y = exp(-1/2*(n/stdev).^2);  
  
plot(n,w)  
hold on  
plot(n,y,'.')  
hold off  
  
xlabel('Samples')  
title('Gaussian Window, N = 64')
```

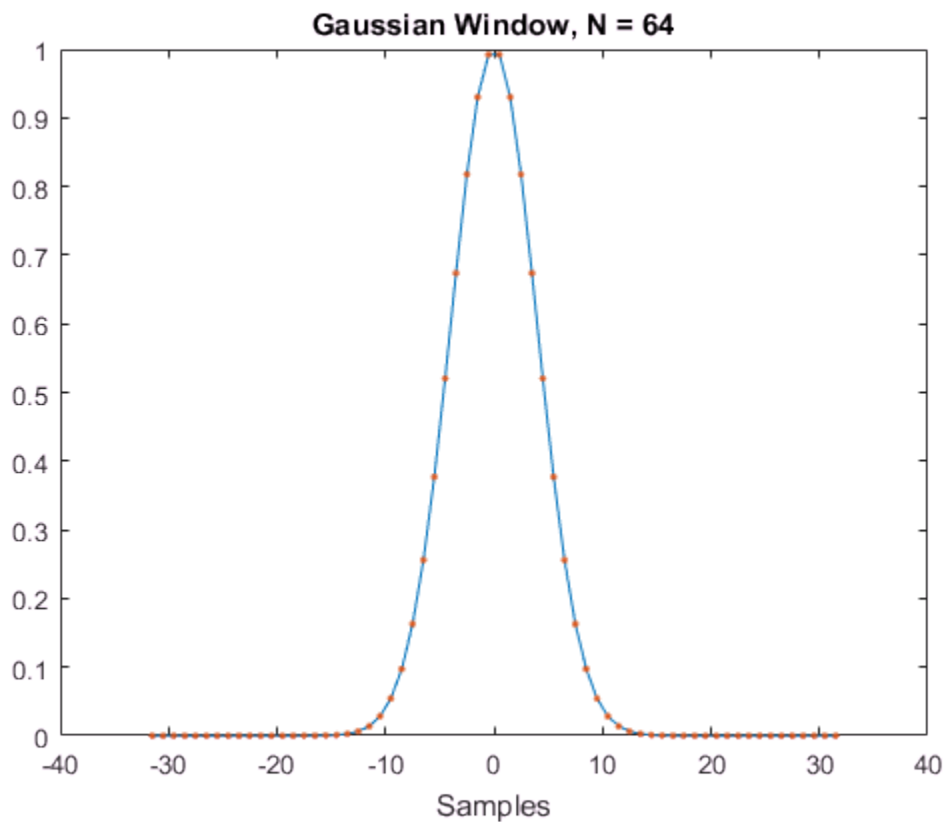

Obtain the Fourier transform of the Gaussian window at 256 points. Use `fftshift` to center the Fourier transform at zero frequency (DC).

```
nfft = 4*N;  
freq = -pi:2*pi/nfft:pi-pi/nfft;  
  
wdft = fftshift(fft(w,nfft));
```

The Fourier transform of the Gaussian window is also Gaussian with a standard deviation that is the reciprocal of the time-domain standard deviation. Include the Gaussian normalization factor in your computation.

```
ydft = exp(-1/2*(freq/(1/stdev)).^2)*(stdev*sqrt(2*pi));  
  
plot(freq/pi,abs(wdft))  
hold on  
plot(freq/pi,abs(ydft),'.')  
hold off  
  
xlabel('Normalized frequency (\times\pi rad/sample)')  
title('Fourier Transform of Gaussian Window')
```

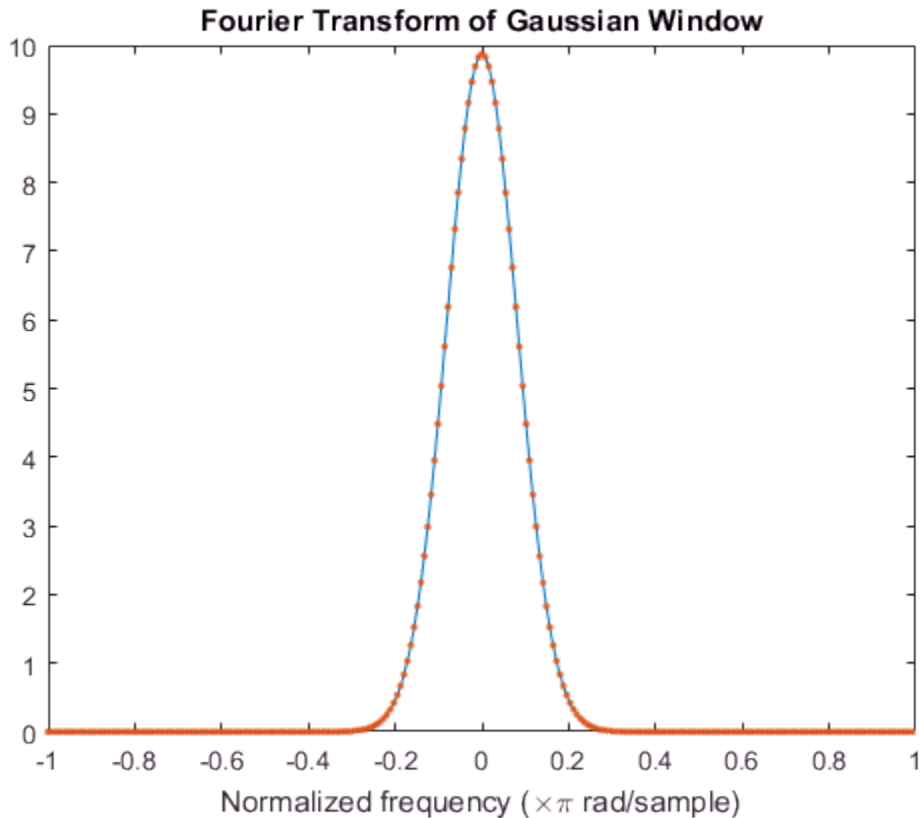

Algorithms

The coefficients of a Gaussian window are computed from the following equation:

$$w(n) = e^{-\frac{1}{2} \left(\alpha \frac{n}{(N-1)/2} \right)^2} = e^{-n^2/2\sigma^2},$$

where $-(N-1)/2 \leq n \leq (N-1)/2$ and α is inversely proportional to the standard deviation, σ , of a Gaussian random variable. The exact correspondence with the standard deviation of a Gaussian probability density function is $\sigma = (N-1)/(2\alpha)$.

References

- [1] Harris, Fredric J. “On the Use of Windows for Harmonic Analysis with the Discrete Fourier Transform.” *Proceedings of the IEEE*. Vol. 66, January 1978, pp.51–83.
- [2] Roberts, Richard A., and C. T. Mullis. *Digital Signal Processing*. Reading, MA: Addison-Wesley, 1987, pp.135–136.

Extended Capabilities

C/C++ Code Generation

Generate C and C++ code using MATLAB® Coder™.

Usage notes and limitations:

All `gaspl` inputs must be constant. Expressions or variables are allowed if their values do not change.

See Also

See Also

Apps

Window Designer

Functions

`chebwin` | `kaiser` | `tukeywin` | `window` | `wvtool`

Introduced before R2006a

gmonopuls

Gaussian monopulse

Syntax

```
y = gmonopuls(t,fc)
tc = gmonopuls('cutoff',fc)
```

Description

`y = gmonopuls(t,fc)` returns samples of the unit-amplitude Gaussian monopulse with center frequency f_c (in hertz) at the times indicated in array `t`. By default, $f_c = 1000$ Hz.

`tc = gmonopuls('cutoff',fc)` returns the time duration between the maximum and minimum amplitudes of the pulse.

Examples

Gaussian Monopulse

Consider a Gaussian monopulse with center frequency $f_c = 2$ GHz and sampled at a rate of 100 GHz. Determine the cutoff time t_c using the 'cutoff' option and compute the monopulse between $-2t_c$ and $2t_c$.

```
fc = 2e9;
fs = 100e9;

tc = gmonopuls('cutoff',fc);
t = -2*tc:1/fs:2*tc;

y = gmonopuls(t,fc);
```

The monopulse is defined by the equation

$$y(t) = e^{1/2}(t/\sigma) \exp(-(t/\sigma)^2/2),$$

where $\sigma = t_c/2 = 1/(2\pi f_c)$ and the exponential factor is such that $y(\sigma) = 1$. Plot the two curves and verify that they match.

```
sg = 1/(2*pi*fc);
ys = exp(1/2)*t/sg.*exp(-(t/sg).^2/2);
plot(t,y,t,ys,'.')
legend('gmonopuls','Definition')
```

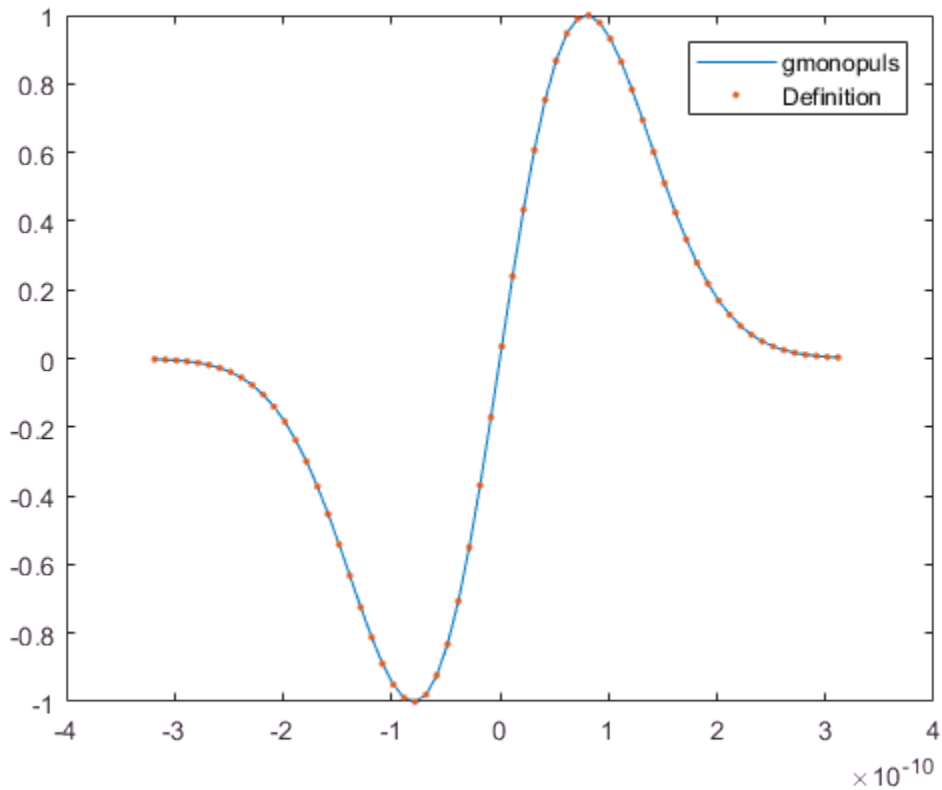

Gaussian Monopulse Pulse Train

Consider a Gaussian monopulse with center frequency $f_c = 2$ GHz and sampled at a rate of 100 GHz. Use the monopulse to construct a pulse train with a spacing of 7.5 ns.

Determine the width t_c of each pulse using the 'cutoff' option. Set the delay times to be integer multiples of the spacing.

```
fc = 2e9;  
fs = 100e9;  
  
tc = gmonopuls('cutoff',fc);  
D = ((0:2)*7.5+2.5)*1e-9;
```

Generate the pulse train such that the total duration is $150t_c$. Plot the result.

```
t = 0:1/fs:150*tc;  
yp = pulstran(t,D,'gmonopuls',fc);  
  
plot(t,yp)
```

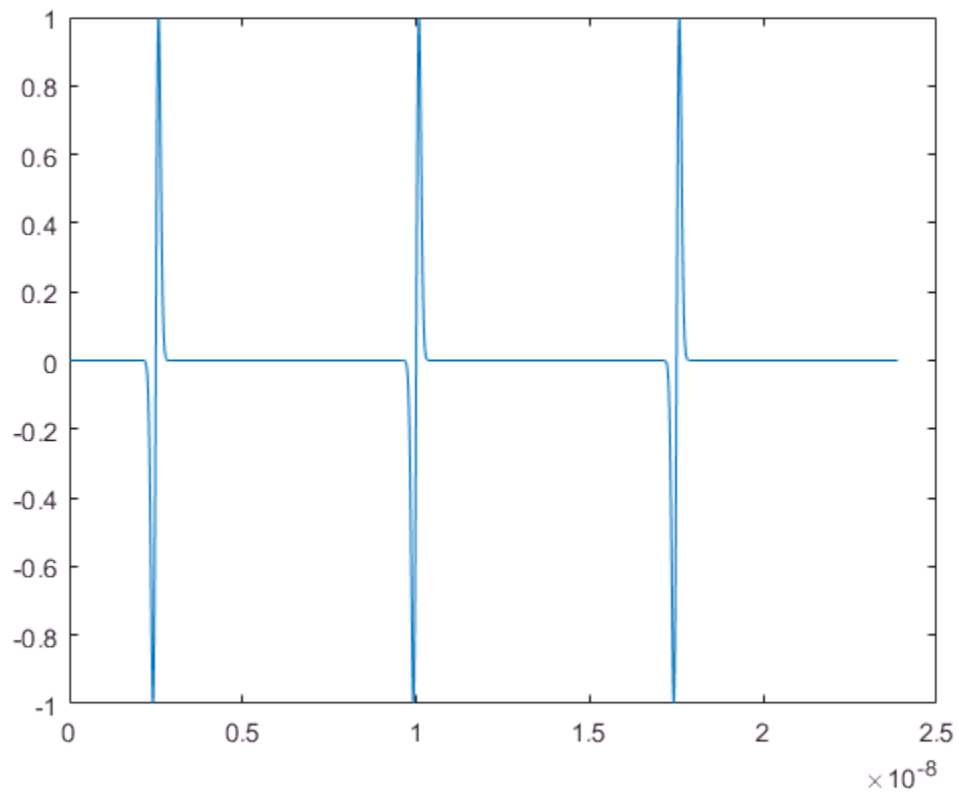

Tips

Default values are substituted for empty or omitted trailing input arguments.

See Also

`chirp` | `gauspuls` | `pulstran` | `rectpuls` | `tripuls`

Introduced before R2006a

goertzel

Discrete Fourier transform with second-order Goertzel algorithm

Syntax

```
dft_data = goertzel(data)
dft_data = goertzel(data,freq_indices)
dft_data = goertzel(data,freq_indices,dim)
```

Description

`dft_data = goertzel(data)` returns the discrete Fourier transform (DFT) of the input data, `data`, using a second-order Goertzel algorithm. If `data` is a matrix, `goertzel` computes the DFT of each column separately.

`dft_data = goertzel(data,freq_indices)` returns the DFT for the frequency indices `freq_indices`.

`dft_data = goertzel(data,freq_indices,dim)` computes the DFT of the matrix `data` along the dimension `dim`.

Examples

Estimate Telephone Keypad Frequencies

Estimate the frequencies of the tone generated by pressing the 1 button on a telephone keypad.

The number 1 produces a tone with frequencies 697 and 1209 Hz. Generate 205 samples of the tone with a sample rate of 8 kHz.

```
Fs = 8000;
N = 205;
lo = sin(2*pi*697*(0:N-1)/Fs);
hi = sin(2*pi*1209*(0:N-1)/Fs);
data = lo + hi;
```

Use the Goertzel algorithm to compute the DFT of the tone. Choose the indices corresponding to the frequencies used to generate the numbers 0 through 9.

```
f = [697 770 852 941 1209 1336 1477];  
freq_indices = round(f/Fs*N) + 1;  
dft_data = goertzel(data,freq_indices);
```

Plot the DFT magnitude.

```
stem(f,abs(dft_data))  
  
ax = gca;  
ax.XTick = f;  
xlabel('Frequency (Hz)')  
title('DFT Magnitude')
```

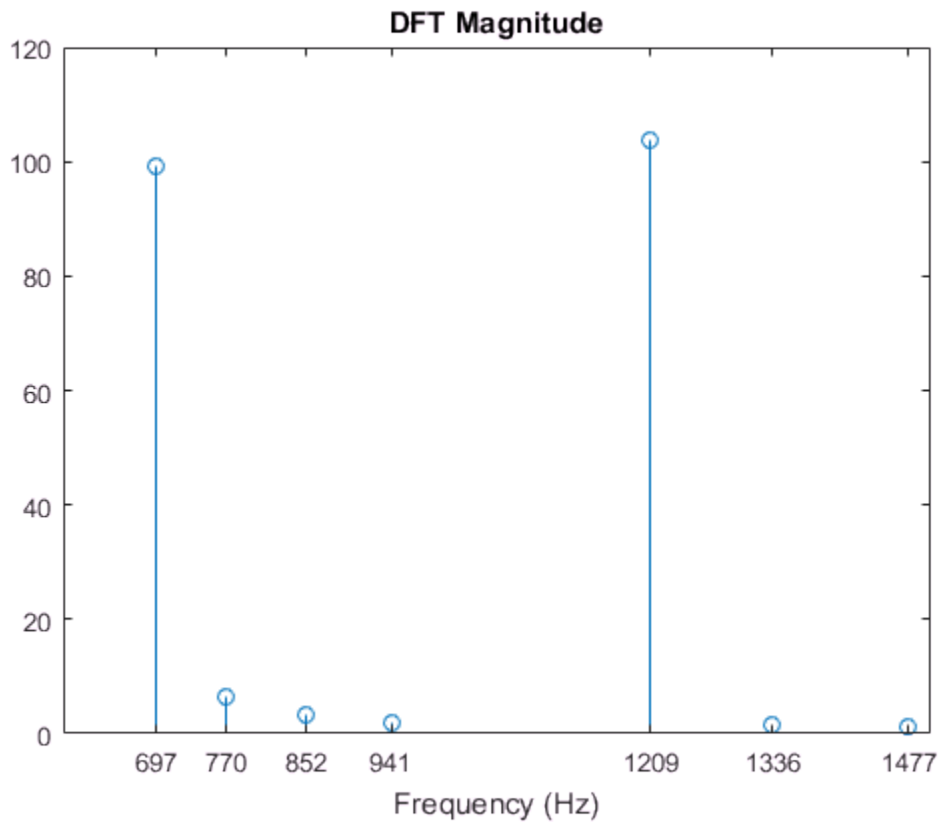

Resolve Frequency Components of a Noisy Tone

Generate a noisy cosine with frequency components at 1.24 kHz, 1.26 kHz, and 10 kHz. Specify a sample rate of 32 kHz. Reset the random number generator for reproducible results.

```
rng default

Fs = 32e3;
t = 0:1/Fs:2.96;
x = cos(2*pi*t*10e3) + cos(2*pi*t*1.24e3) + cos(2*pi*t*1.26e3) ...
    + randn(size(t));
```

Generate the frequency vector. Use the Goertzel algorithm to compute the DFT. Restrict the range of frequencies to between 1.2 and 1.3 kHz.

```
N = (length(x)+1)/2;
f = (Fs/2)/N*(0:N-1);
indxs = find(f>1.2e3 & f<1.3e3);
X = goertzel(x,indxs);
```

Plot the mean squared spectrum expressed in decibels.

```
plot(f(indxs)/1e3,mag2db(abs(X)/length(X)))

title('Mean Squared Spectrum')
xlabel('Frequency (kHz)')
ylabel('Power (dB)')
grid
```

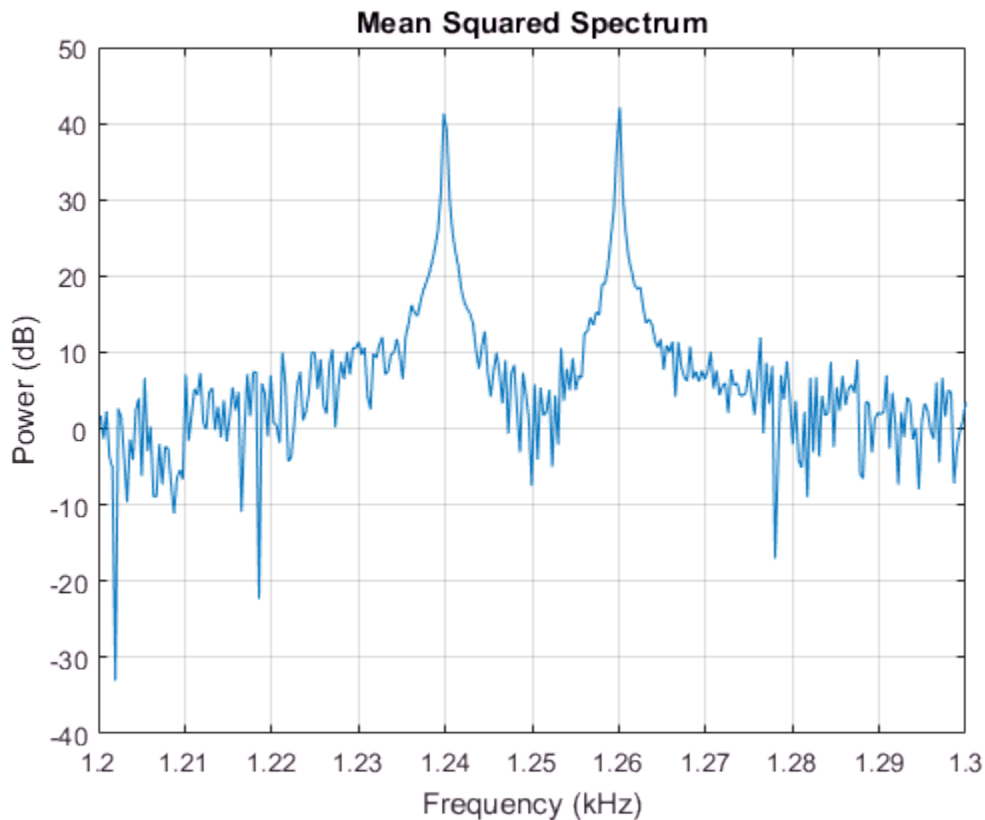

Algorithms

The Goertzel algorithm implements the DFT as a recursive difference equation. To establish this difference equation, express the DFT as the convolution of an N -point input, $x(n)$, with the impulse response $h(n) = W_N^{-kn}u(n)$, where $W_N^{-kn} = e^{-j2\pi k/N}$ and $u(n)$ is the unit step sequence.

The Z-transform of the impulse response is

$$H(z) = \frac{1 - W_N^k z^{-1}}{1 - 2 \cos(2\pi k / N) z^{-1} + z^{-2}}$$

The direct form II implementation is:

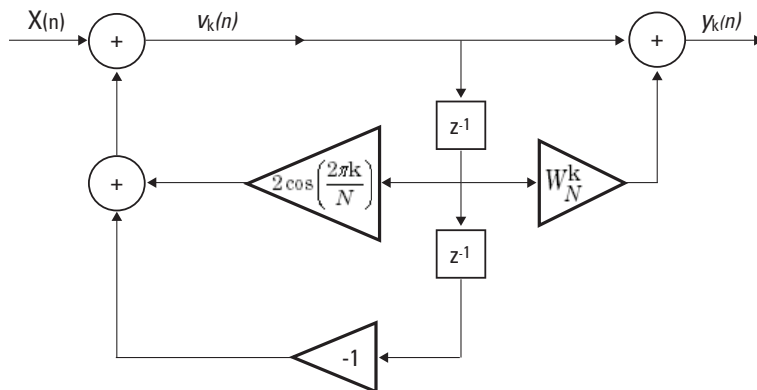

Alternatives

You can also compute the DFT with:

- `fft`: less efficient than the Goertzel algorithm when you only need the DFT at a few frequencies.
- `czt`, the chirp Z-transform. `czt` calculates the Z-transform of an input on a circular or spiral contour and includes the DFT as a special case.

References

Proakis, John G., and Dimitris G. Manolakis. *Digital Signal Processing: Principles, Algorithms, and Applications*. 3rd Edition. Upper Saddle River, NJ: Prentice Hall, 1996, pp. 480–481.

Burrus, C. Sidney, and Thomas W. Parks. *DFT/FFT and Convolution Algorithms: Theory and Implementation*. New York: John Wiley & Sons, 1985.

Introduced before R2006a

grpdelay

Average filter delay (group delay)

Syntax

```
[gd,w] = grpdelay(b,a)
[gd,w] = grpdelay(b,a,n)
[gd,w] = grpdelay(sos,n)
[gd,w] = grpdelay(d,n)
[gd,f] = grpdelay(...,n,fs)
[gd,w] = grpdelay(...,n,'whole')
[gd,f] = grpdelay(...,n,'whole',fs)
gd = grpdelay(...,w)
gd = grpdelay(...,f,fs)
grpdelay(...)
```

Description

`[gd,w] = grpdelay(b,a)` returns the group delay response, **gd**, of the discrete-time filter specified by the input vectors, **b** and **a**. The input vectors are the coefficients for the numerator, **b**, and denominator, **a**, polynomials in z^{-1} . The Z-transform of the discrete-time filter is

$$H(z) = \frac{B(z)}{A(z)} = \frac{\sum_{l=0}^{N-1} b(l+1)z^{-l}}{\sum_{l=0}^{M-1} a(l+1)z^{-l}},$$

The filter's group delay response is evaluated at 512 equally spaced points in the interval $[0,\pi)$ on the unit circle. The evaluation points on the unit circle are returned in **w**.

`[gd,w] = grpdelay(b,a,n)` returns the group delay response of the discrete-time filter evaluated at **n** equally spaced points on the unit circle in the interval $[0,\pi)$. **n** is a positive integer. For best results, set **n** to a value greater than the filter order.

`[gd,w] = grpdelay(sos,n)` returns the group delay response for the second-order sections matrix, `sos`. `sos` is a K -by-6 matrix, where the number of sections, K , must be greater than or equal to 2. If the number of sections is less than 2, `grpdelay` considers the input to be the numerator vector, `b`. Each row of `sos` corresponds to the coefficients of a second-order (biquad) filter. The i th row of the `sos` matrix corresponds to `[bi(1) bi(2) bi(3) ai(1) ai(2) ai(3)]`.

`[gd,w] = grpdelay(d,n)` returns the group delay response for the digital filter, `d`. Use `designfilt` to generate `d` based on frequency-response specifications.

`[gd,f] = grpdelay(...,n,fs)` specifies a positive sampling frequency `fs` in hertz. It returns a length- n vector, `f`, containing the frequency points in hertz at which the group delay response is evaluated. `f` contains n points between 0 and $fs/2$.

`[gd,w] = grpdelay(...,n,'whole')` and `[gd,f] = grpdelay(...,n,'whole',fs)` use n points around the whole unit circle (from 0 to 2π , or from 0 to `fs`).

`gd = grpdelay(...,w)` and `gd = grpdelay(...,f,fs)` return the group delay response evaluated at the angular frequencies in `w` (in radians/sample) or in `f` (in cycles/unit time), respectively, where `fs` is the sampling frequency. `w` and `f` are vectors with at least two elements.

`grpdelay(...)` with no output arguments plots the group delay response versus frequency.

`grpdelay` works for both real and complex filters.

Note: If the input to `grpdelay` is single precision, the group delay is calculated using single-precision arithmetic. The output, `gd`, is single precision.

Examples

Group Delay of a Butterworth Filter

Design a Butterworth filter of order 6 with normalized 3-dB frequency 0.2π rad/sample. Use `grpdelay` to display the group delay.

```
[z,p,k] = butter(6,0.2);
sos = zp2sos(z,p,k);
grpdelay(sos,128)
```

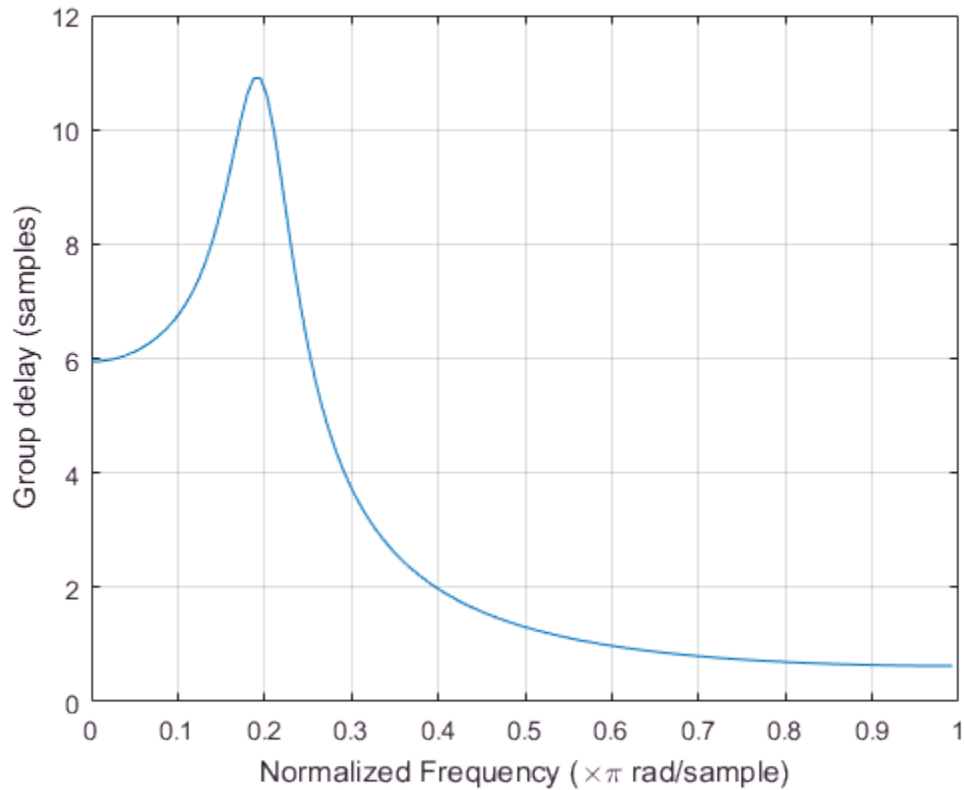

Plot both the group delay and the phase delay of the system on the same figure.

```
gd = grpdelay(sos,512);
[h,w] = freqz(sos,512);
pd = -unwrap(angle(h))./w;
plot(w/pi,gd,w/pi,pd), grid
xlabel 'Normalized Frequency (\times\pi rad/sample)'
ylabel 'Group and phase delays'
legend('Group delay','Phase delay')
```

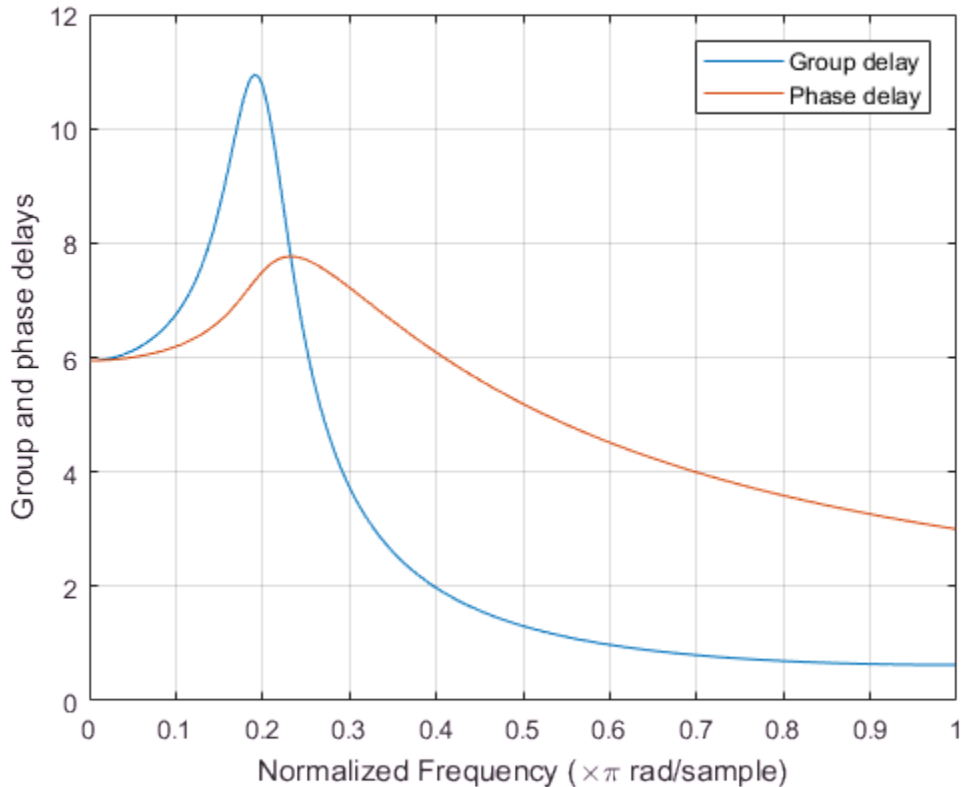

Group Delay Response of a Butterworth digitalFilter

Use `designfilt` to design a sixth-order Butterworth Filter with normalized 3-dB frequency 0.2π rad/sample. Display its group delay response.

```
d = designfilt('lowpassiir','FilterOrder',6, ...  
              'HalfPowerFrequency',0.2,'DesignMethod','butter');  
grpdelay(d)
```

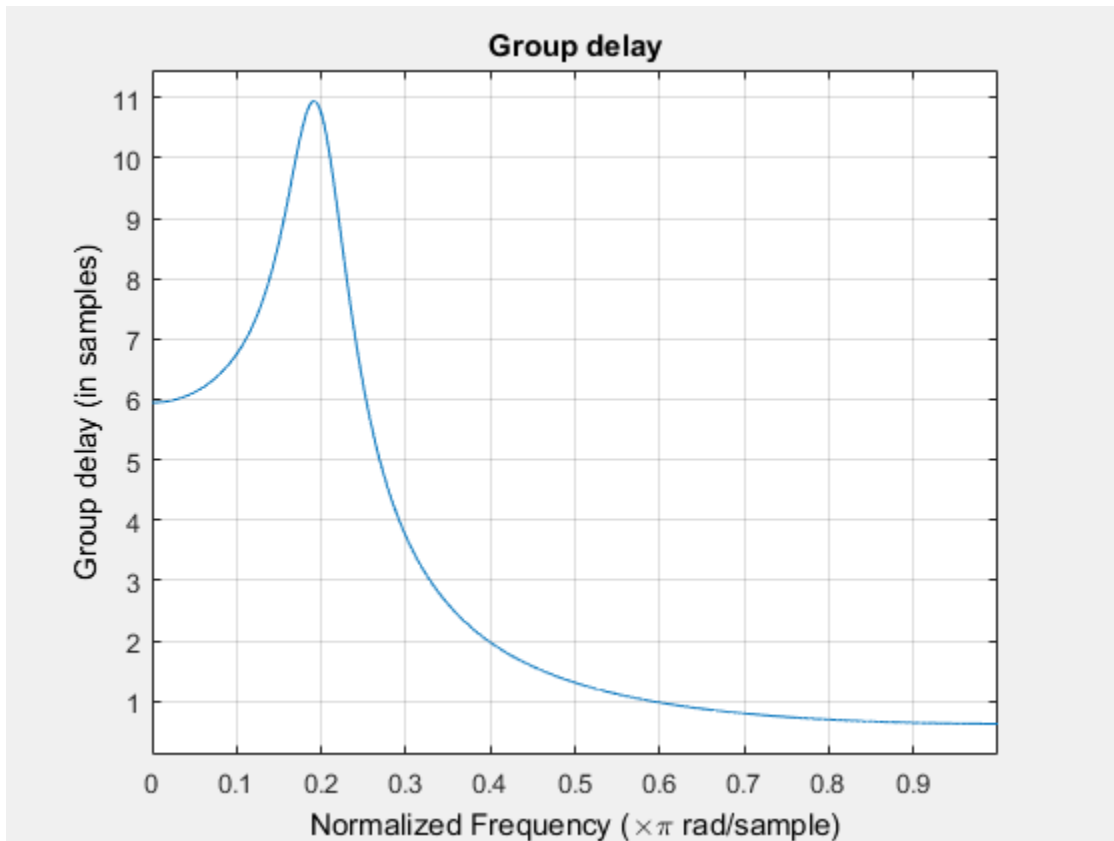

Definitions

Group Delay

The *group delay response* of a filter is a measure of the average delay of the filter as a function of frequency. It is the negative first derivative of the phase response of the filter. If the frequency response of a filter is $H(e^{j\omega})$, then the group delay is

$$\tau_g(\omega) = -\frac{d\theta(\omega)}{d\omega}$$

where $\theta(\omega)$ is the phase, or argument, of $H(e^{j\omega})$.

Algorithms

`grpdelay` multiplies the filter coefficients by a unit ramp. After Fourier transformation, this process corresponds to differentiation.

See Also

See Also

`cceps` | `designfilt` | `digitalFilter` | `fft` | `freqz` | `fvtool` | `hilbert` | `icceps` | `phasedelay` | `rceps`

Introduced before R2006a

hamming

Hamming window

Syntax

```
w = hamming(L)
w = hamming(L, 'sflag')
```

Description

`w = hamming(L)` returns an L-point symmetric Hamming window in the column vector `w`. `L` should be a positive integer. The coefficients of a Hamming window are computed from the following equation.

$$w(n) = 0.54 - 0.46 \cos\left(2\pi \frac{n}{N}\right), \quad 0 \leq n \leq N$$

The window length is $L = N + 1$.

`w = hamming(L, 'sflag')` returns an L-point Hamming window using the window sampling specified by `'sflag'`, which can be either `'periodic'` or `'symmetric'` (the default). The `'periodic'` flag is useful for DFT/FFT purposes, such as in spectral analysis. The DFT/FFT contains an implicit periodic extension and the periodic flag enables a signal windowed with a periodic window to have perfect periodic extension. When `'periodic'` is specified, `hamming` computes a length `L+1` window and returns the first `L` points. When using windows for filter design, the `'symmetric'` flag should be used.

Note If you specify a one-point window (`L=1`), the value 1 is returned.

Examples

Hamming Window

Create a 64-point Hamming window. Display the result using `wvtool`.

```
L = 64;
wvtool(hamming(L))
```

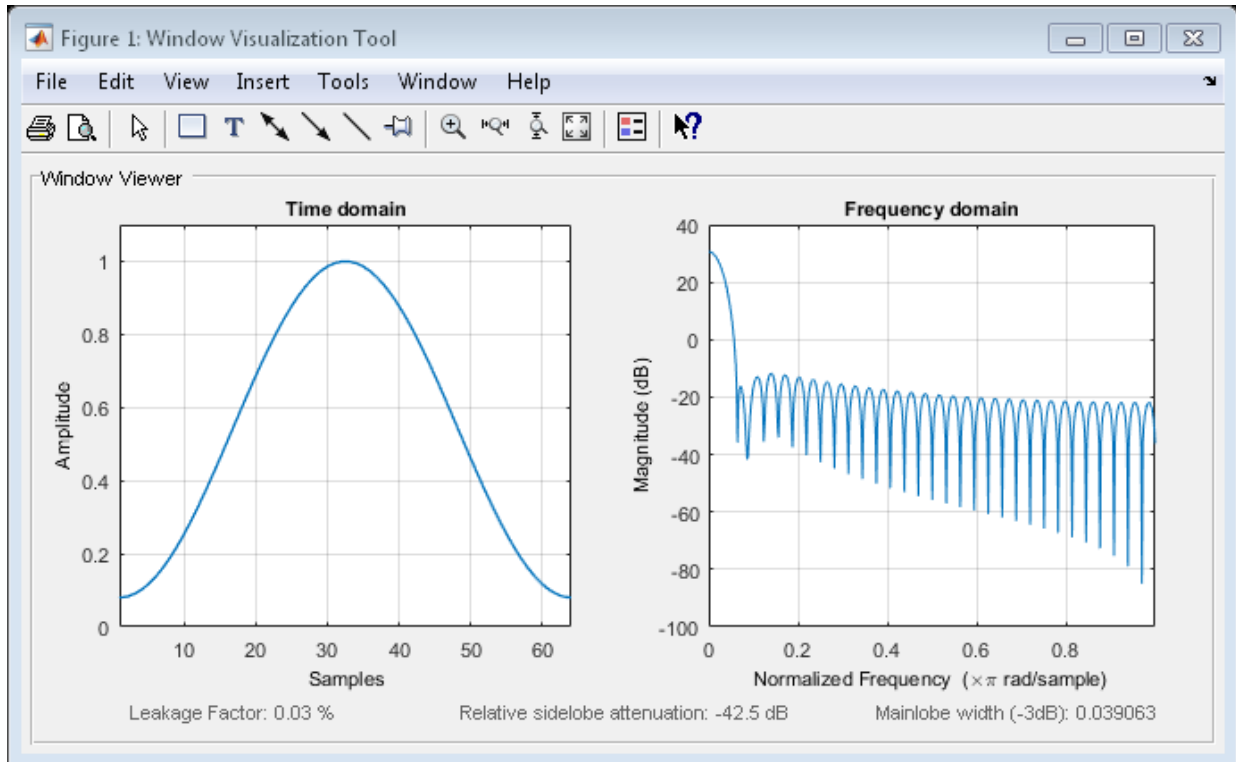

References

- [1] Oppenheim, Alan V., Ronald W. Schaffer, and John R. Buck. *Discrete-Time Signal Processing*. Upper Saddle River, NJ: Prentice Hall, 1999, p. 468.

Extended Capabilities

C/C++ Code Generation

Generate C and C++ code using MATLAB® Coder™.

Usage notes and limitations:

All inputs must be constant. Expressions or variables are allowed if their values do not change.

See Also

See Also

Apps

Window Designer

Functions

blackman | flattopwin | hann | window | wvtool

Introduced before R2006a

hampel

Outlier removal using Hampel identifier

Syntax

```
y = hampel(x)
y = hampel(x,k)
y = hampel(x,k,nsigma)

[y,j] = hampel( ___ )
[y,j,xmedian,xsigma] = hampel( ___ )

hampel( ___ )
```

Description

`y = hampel(x)` applies a Hampel filter to the input vector, `x`, to detect and remove outliers. For each sample of `x`, the function computes the median of a window composed of the sample and its six surrounding samples, three per side. It also estimates the standard deviation of each sample about its window median using the median absolute deviation. If a sample differs from the median by more than three standard deviations, it is replaced with the median. If `x` is a matrix, then `hampel` treats each column of `x` as an independent channel.

`y = hampel(x,k)` specifies the number of neighbors, `k`, on either side of each sample of `x` in the measurement window.

`y = hampel(x,k,nsigma)` specifies a number of standard deviations, `nsigma`, by which a sample of `x` must differ from the local median for it to be replaced with the median.

`[y,j] = hampel(___)` also returns a logical matrix that is true at the locations of all points identified as outliers. This syntax accepts any of the input arguments from previous syntaxes.

`[y,j,xmedian,xsigma] = hampel(___)` also returns the local medians and the estimated standard deviations for each element of `x`.

`hampel(___)` with no output arguments plots the filtered signal and annotates the outliers that were removed.

Examples

Remove Spikes from Sinusoid

Generate 100 samples of a sinusoidal signal. Replace the sixth and twentieth samples with spikes.

```
x = sin(2*pi*(0:99)/100);  
x(6) = 2;  
x(20) = -2;
```

Use `hampel` to locate every sample that differs by more than three standard deviations from the local median. The measurement window is composed of the sample and its six surrounding samples, three per side.

```
[y,i,xmedian,xsigma] = hampel(x);
```

Plot the filtered signal and annotate the outliers.

```
n = 1:length(x);  
plot(n,x)  
hold on  
plot(n,xmedian-3*xsigma,n,xmedian+3*xsigma)  
plot(find(i),x(i),'sk')  
hold off  
legend('Original signal','Lower limit','Upper limit','Outliers')
```

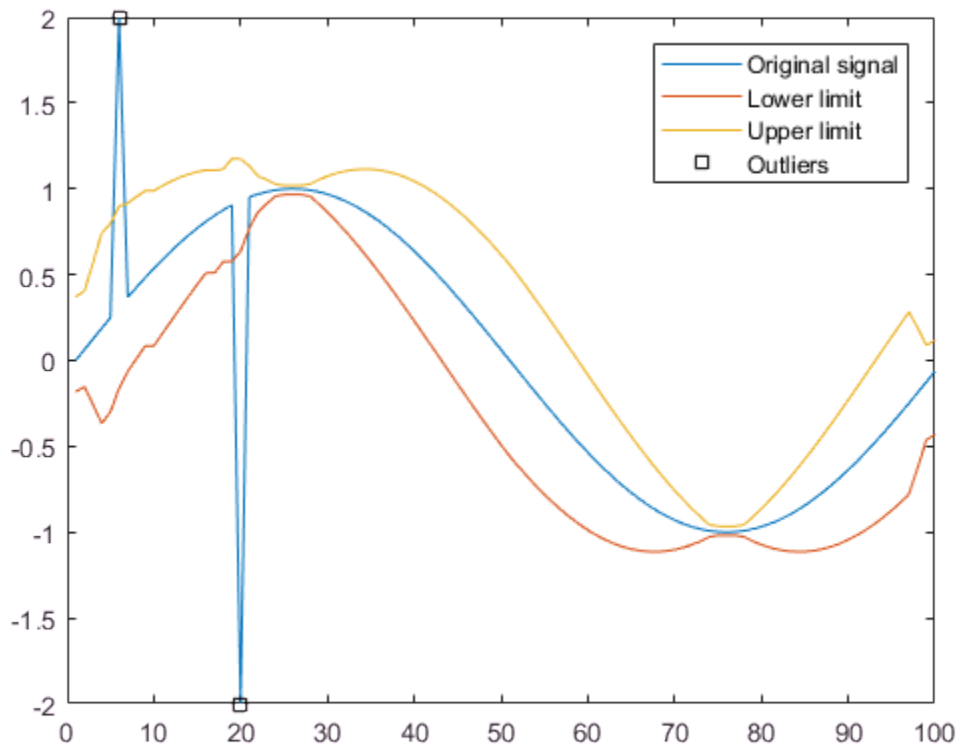

Repeat the computation, but now take just one adjacent sample on each side when computing the median. The function considers the extrema as outliers.

```
hampel(x, 1)
```

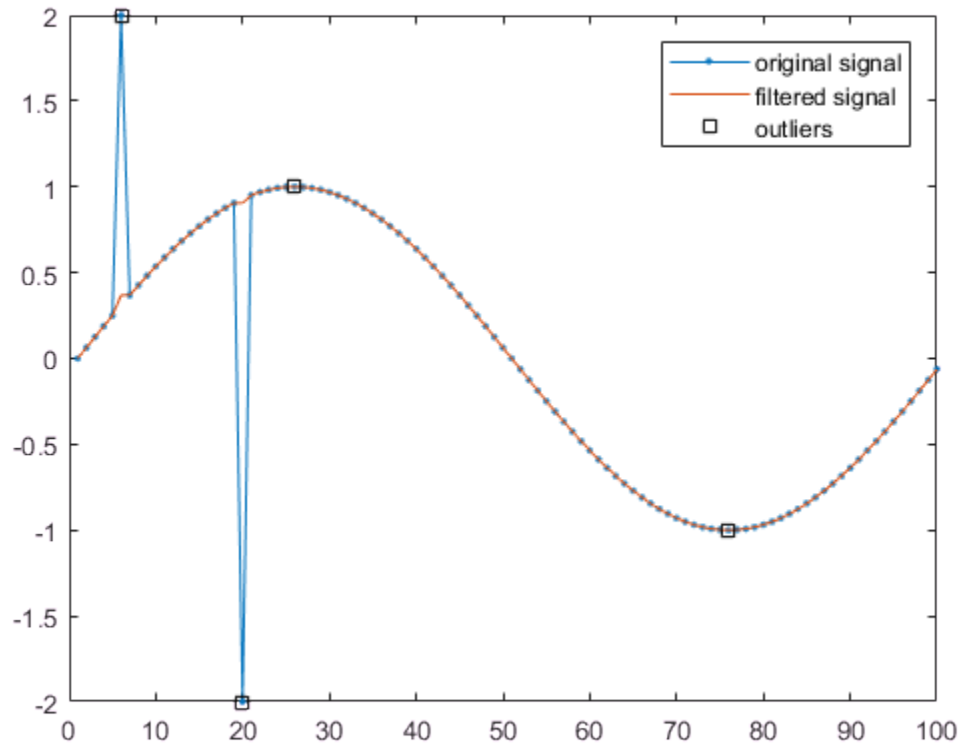

Hampel Filtering of Multichannel Signal

Generate a two-channel signal consisting of sinusoids of different frequencies. Place spikes in random places. Use NaNs to add missing samples at random. Reset the random number generator for reproducible results. Plot the signal.

```
rng('default')
n = 59;
x = sin(pi./[15 10]'.*(1:n)+pi/3)';
spk = randi(2*n,9,1);
```

```
x(spk) = x(spk)*2;  
x(randi(2*n,6,1)) = NaN;  
  
plot(x)
```

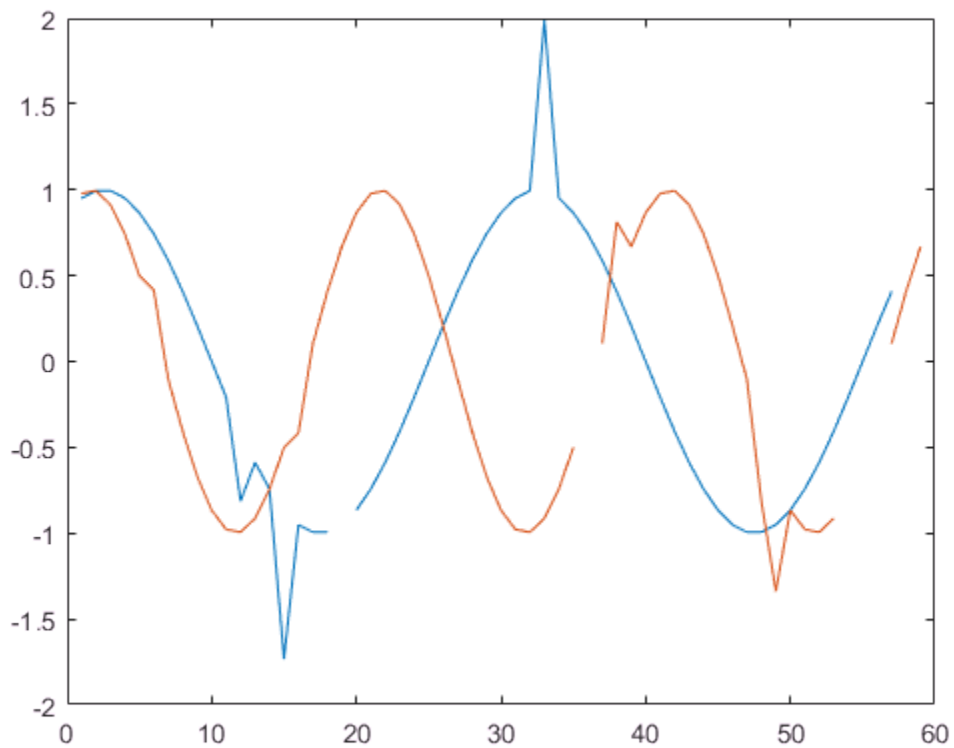

Filter the signal using `hampel` with the default settings.

```
y = hamper(x);  
plot(y)
```

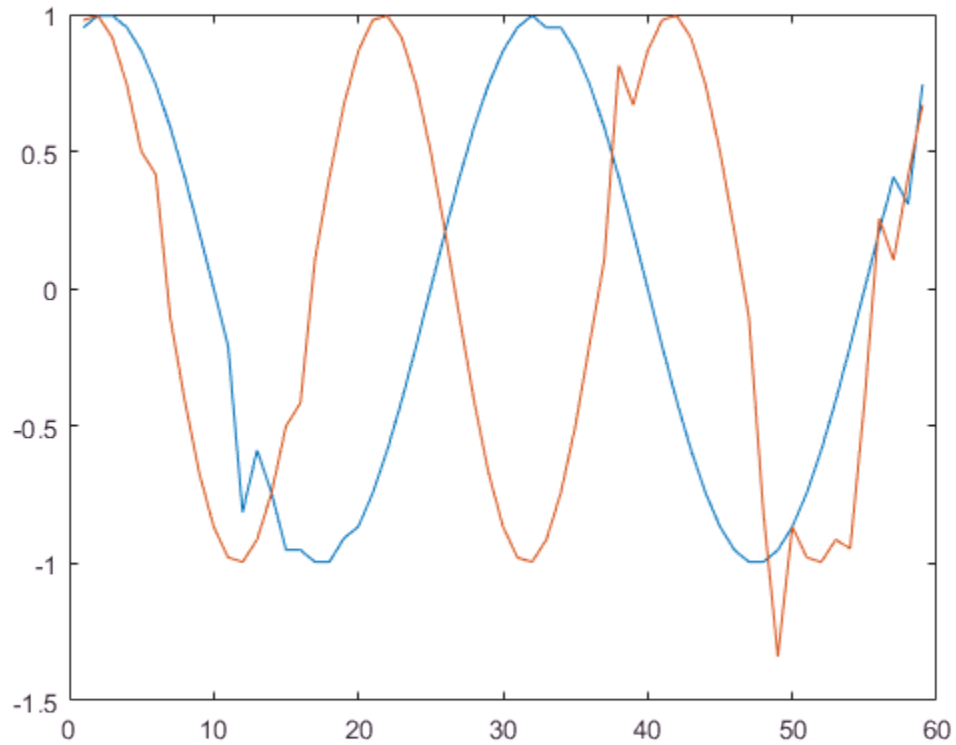

Increase the length of the moving window and decrease the threshold to treat a sample as an outlier.

```
y = hampel(x,4,2);  
plot(y)
```

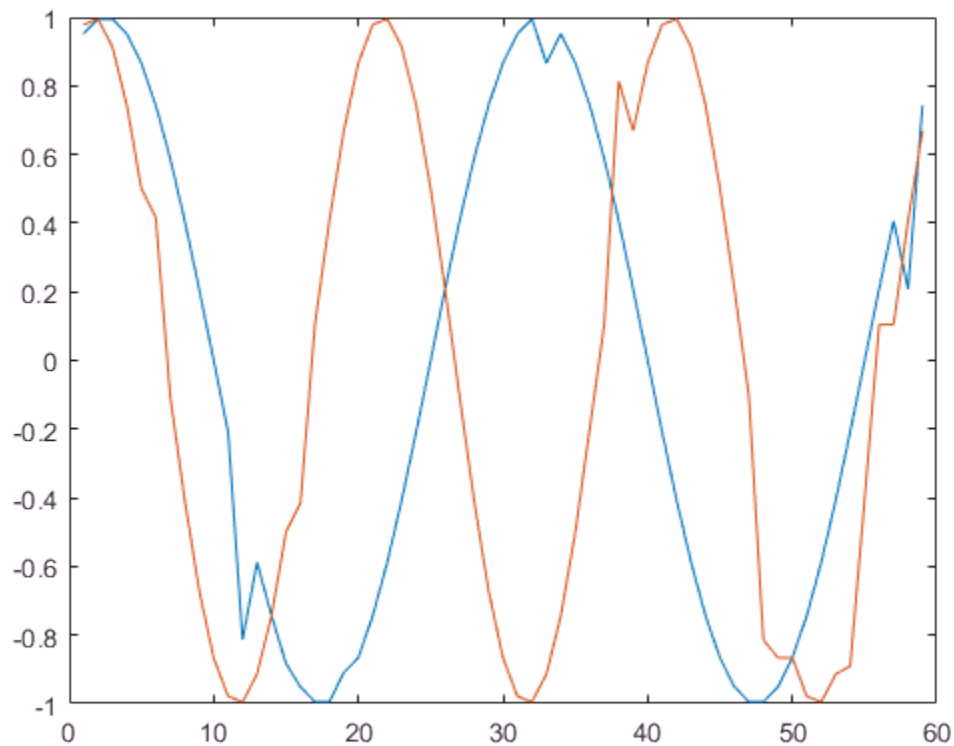

Output the running median for each channel. Overlay the medians on a plot of the signal.

```
[y, j, xmd, xsd] = hampe1(x, 4, 2);  
plot(x)  
hold on  
plot(xmd, '--')
```

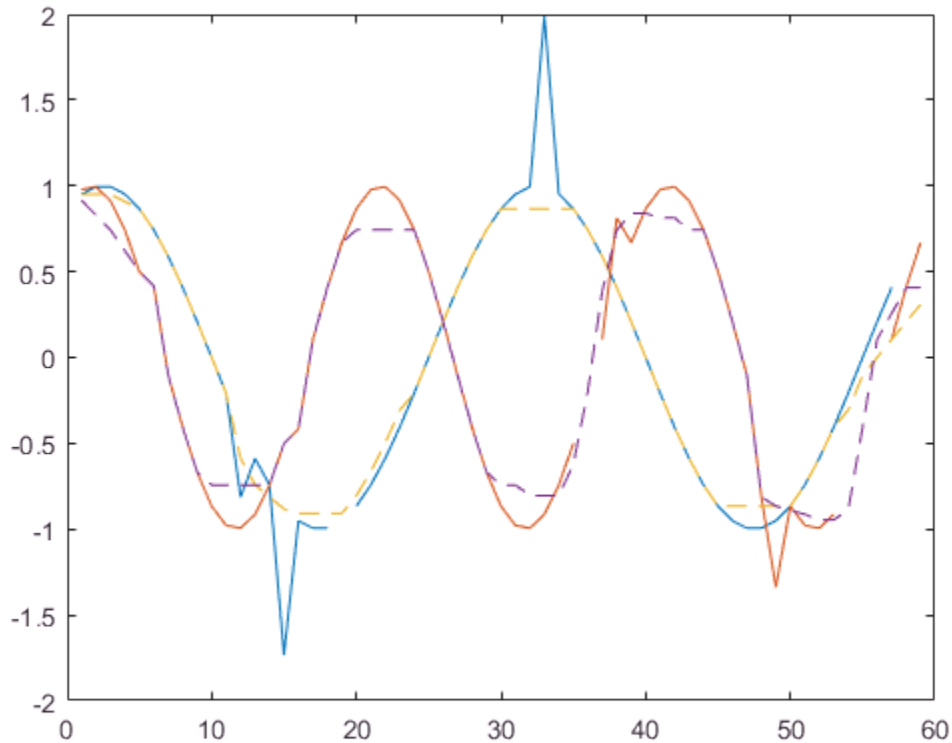

Find Outliers in Multichannel Signal

Generate a multichannel signal that consists of two sinusoids of different frequencies embedded in white Gaussian noise of unit variance.

```
rng('default')
t = 0:60;
x = sin(pi./[10;2]*t)'+randn(numel(t),2);
```

Apply a Hampel filter to the signal. Take as outliers those points that differ by more than two standard deviations from the median of a surrounding nine-sample window. Output a logical matrix that is true at the locations of the outliers.

```
k = 4;
nsig = 2;

[y,h] = hampe1(x,k,nsig);
```

Plot each channel of the signal in its own set of axes. Draw the original signal, the filtered signal, and the outliers. Annotate the outlier locations.

```
for k = 1:2
    hk = h(:,k);
    ax = subplot(2,1,k);
    plot(t,x(:,k))
    hold on
    plot(t,y(:,k))
    plot(t(hk),x(hk,k), '*')
    hold off
    ax.XTick = t(hk);
end
```

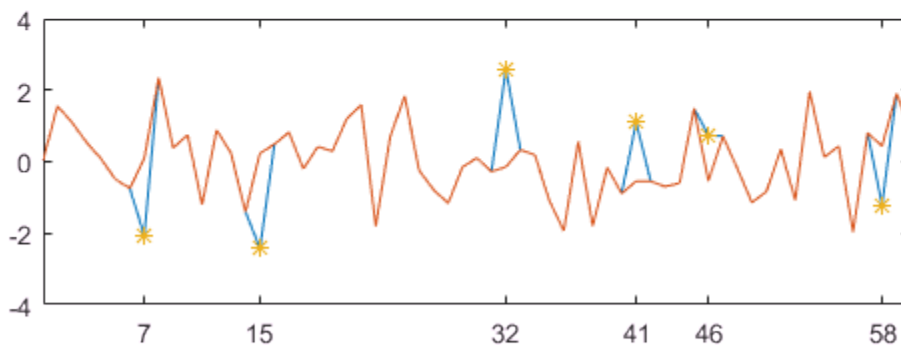
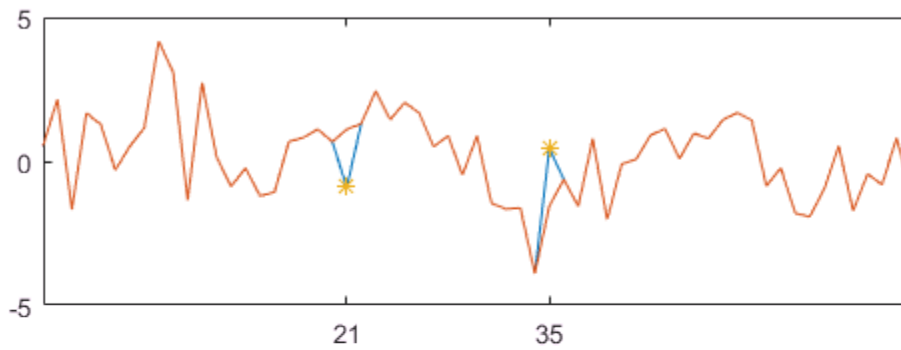
Signal Statistics Returned by Hampel Filter

Generate 100 samples of a sinusoidal signal. Replace the sixth and twentieth samples with spikes.

```
n = 1:100;
x = sin(2*pi*n/100);
x(6) = 2;
x(20) = -2;
```

Use `hampel` to compute the local median and estimated standard deviation for every sample. Use the default values of the input parameters:

- The window size is $2 \times 3 + 1 = 7$.
- The points that differ from their window median by more than three standard deviations are considered outliers.

Plot the result.

```
[y,i,xmedian,xsigma] = hampel(x);  
  
plot(n,x)  
hold on  
plot(n,[1;1]*xmedian+3*[-1;1]*xsigma)  
plot(find(i),x(i),'sk')  
hold off  
legend('Signal','Lower','Upper','Outliers')
```

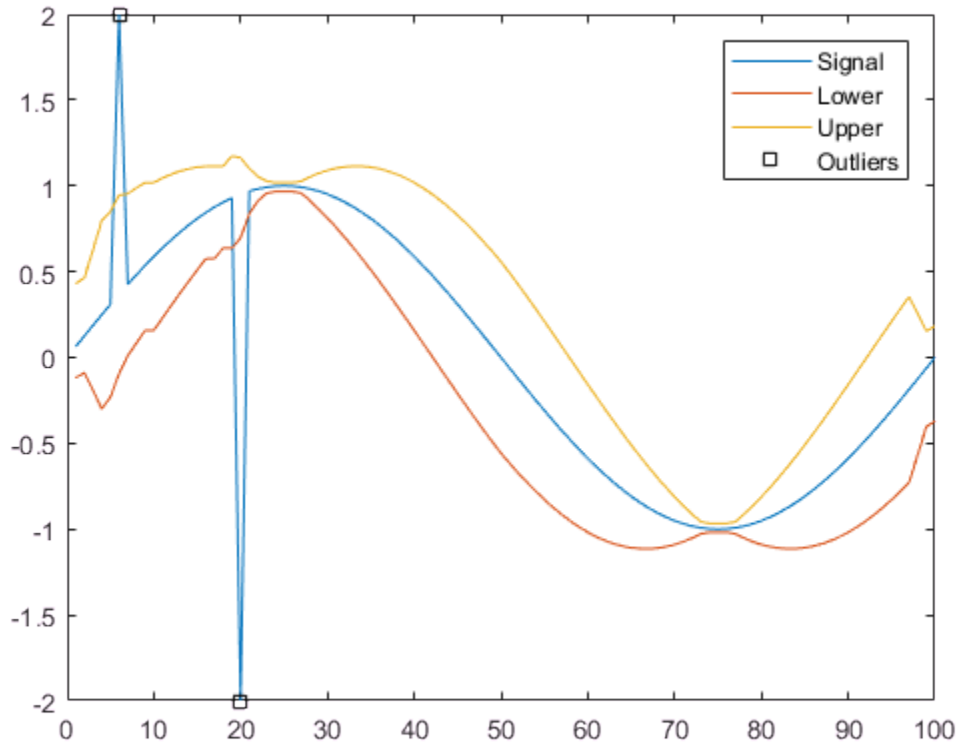

Repeat the calculation using a window size of $2 \times 10 + 1 = 21$ and two standard deviations as the criteria for identifying outliers.

```
sds = 2;
adj = 10;
[y,i,xmedian,xsigma] = hampel(x,adj,sds);

plot(n,x)
hold on
plot(n,[1;1]*xmedian+sds*[-1;1]*xsigma)
plot(find(i),x(i),'sk')
hold off
legend('Signal','Lower','Upper','Outliers')
```

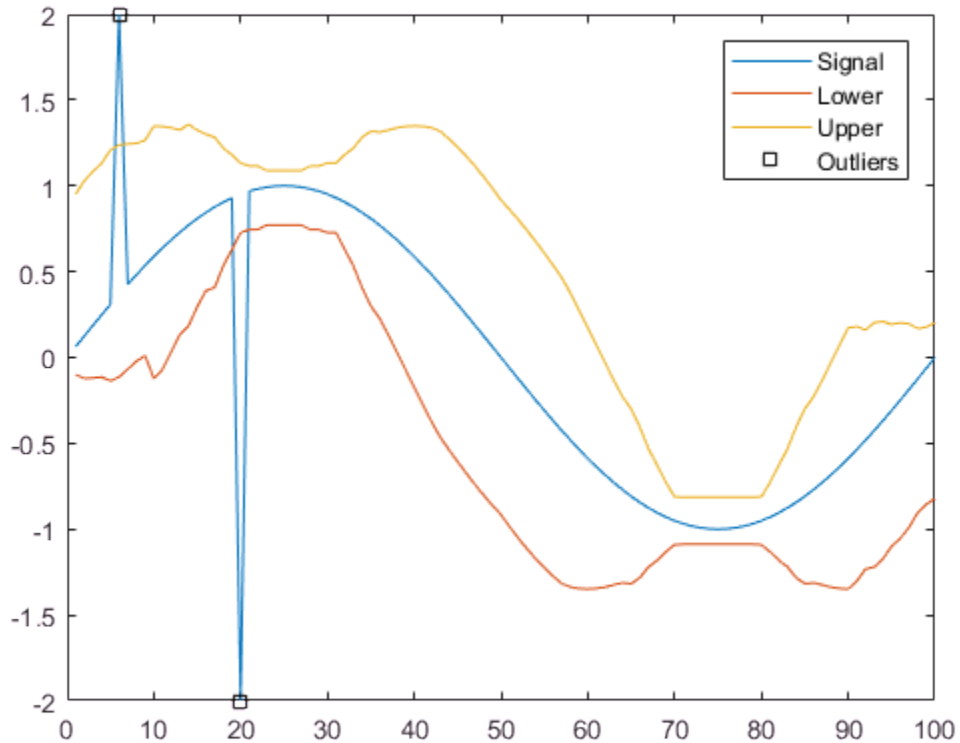

Input Arguments

x — Input signal

vector | matrix

Input signal, specified as a vector or matrix. If **x** is a matrix, then `hampel` treats each column of **x** as an independent channel.

Example: `cos(pi/4*(0:159))+randn(1,160)` is a single-channel row-vector signal.

Example: `cos(pi./[4;2]*(0:159))'+randn(160,2)` is a two-channel signal.

Data Types: `single` | `double`

k — Number of neighbors on either side

3 (default) | integer scalar

Number of neighbors on either side of the sample x_s , specified as an integer scalar. Samples close to the signal edges that have fewer than k samples on one side are compared to the median of a smaller window.

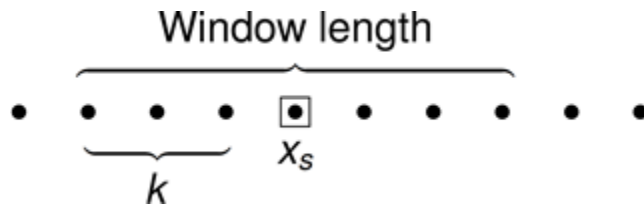

Data Types: `single` | `double`

nsigma — Number of standard deviations

3 (default) | real scalar

Number of standard deviations by which a sample of x must differ from its local median to be considered an outlier. Specify `nsigma` as a real scalar. The function estimates the standard deviation by scaling the local median absolute deviation (MAD) by a factor of

$$\kappa = \frac{1}{\sqrt{2} \operatorname{erfc}^{-1} 1/2} \approx 1.4826$$

Data Types: `single` | `double`

Output Arguments

y — Filtered signal

vector | matrix

Filtered signal, returned as a vector or matrix of the same size as x .

Data Types: `single` | `double`

j — Outlier index

vector | matrix

Outlier index, returned as a vector or matrix of the same size as \mathbf{x} .

Data Types: `logical`

xmedian — Local medians

vector | matrix

Local medians, returned as a vector or matrix of the same size as \mathbf{x} .

Data Types: `single` | `double`

xsigma — Estimated standard deviations

vector | matrix

Estimated standard deviations, returned as a vector or matrix of the same size as \mathbf{x} .

Data Types: `single` | `double`

Definitions

Hampel Identifier

The Hampel identifier is a variation of the three-sigma rule of statistics that is robust against outliers.

Given a sequence $x_1, x_2, x_3, \dots, x_n$ and a sliding window of length k , define point-to-point median and standard-deviation estimates using:

- Local median — $m_i = \text{median}(x_{i-k}, x_{i-k+1}, x_{i-k+2}, \dots, x_i, \dots, x_{i+k-2}, x_{i+k-1}, x_{i+k})$
- Standard deviation — $\sigma_i = \kappa \text{median}(|x_{i-k} - m_i|, \dots, |x_{i+k} - m_i|)$, where

$$\kappa = \frac{1}{\sqrt{2} \operatorname{erfc}^{-1} 1/2} \approx 1.4826$$

The quantity σ_i / κ is known as the median absolute deviation (MAD).

If a sample x_i is such that

$$|x_i - m_i| > n_\sigma \sigma_i$$

for a given threshold n_o , then the Hampel identifier declares x_i an outlier and replaces it with m_i .

Near the sequence endpoints, the function truncates the window used to compute m_i and σ_i :

- $i < k + 1$

$$m_i = \text{median}(x_1, x_2, x_3, \dots, x_i, \dots, x_{i+k-2}, x_{i+k-1}, x_{i+k})$$

$$\sigma_i = \kappa \text{median}(|x_1 - m_1|, \dots, |x_{i+k} - m_i|)$$

- $i > n - k$

$$m_i = \text{median}(x_{i-k}, x_{i-k+1}, x_{i-k+2}, \dots, x_i, \dots, x_{n-2}, x_{n-1}, x_n)$$

$$\sigma_i = \kappa \text{median}(|x_{i-k} - m_i|, \dots, |x_n - m_n|)$$

References

- [1] Liu, Hancong, Sirish Shah, and Wei Jiang. “On-line outlier detection and data cleaning.” *Computers and Chemical Engineering*. Vol. 28, March 2004, pp. 1635–1647.
- [2] Suomela, Jukka. “Median Filtering Is Equivalent to Sorting.” 2014.

See Also

See Also

filloutliers | filter | isoutlier | mad | medfilt1 | median | movmad |
movmedian | sgolayfilt

Introduced in R2015b

hann

Hann (Hanning) window

Syntax

```
w = hann(L)
w = hann(L, 'sflag')
```

Description

`w = hann(L)` returns an L -point symmetric Hann window in the column vector w . L must be a positive integer. The coefficients of a Hann window are computed from the following equation.

$$w(n) = 0.5 \left(1 - \cos \left(2\pi \frac{n}{N} \right) \right), \quad 0 \leq n \leq N$$

The window length is $L = N + 1$.

`w = hann(L, 'sflag')` returns an L -point Hann window using the window sampling specified by `'sflag'`, which can be either `'periodic'` or `'symmetric'` (the default). The `'periodic'` flag is useful for DFT/FFT purposes, such as in spectral analysis. The DFT/FFT contains an implicit periodic extension and the periodic flag enables a signal windowed with a periodic window to have perfect periodic extension. When `'periodic'` is specified, `hann` computes a length $L+1$ window and returns the first L points. When using windows for filter design, the `'symmetric'` flag should be used.

Note If you specify a one-point window ($L=1$), the value 1 is returned.

Examples

Hann Window

Create a 64-point Hann window. Display the result using `wvtool`.

```
L = 64;  
wvtool(hann(L))
```

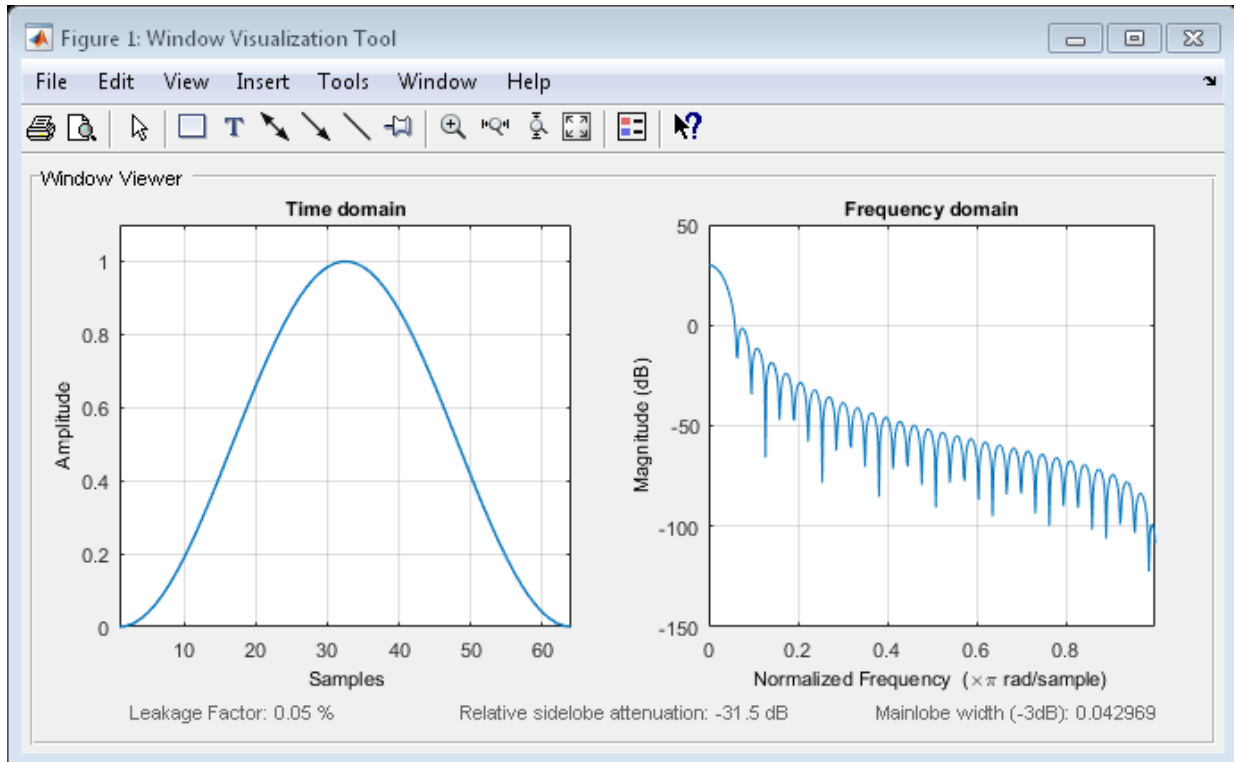

References

- [1] Oppenheim, Alan V., Ronald W. Schaffer, and John R. Buck. *Discrete-Time Signal Processing*. Upper Saddle River, NJ: Prentice Hall, 1999, p. 468.

Extended Capabilities

C/C++ Code Generation

Generate C and C++ code using MATLAB® Coder™.

Usage notes and limitations:

All inputs must be constant. Expressions or variables are allowed if their values do not change.

See Also

See Also

Apps

Window Designer

Functions

blackman | flattopwin | hamming | window | wvtool

Introduced before R2006a

hilbert

Discrete-time analytic signal using Hilbert transform

Syntax

```
x = hilbert(xr)
x = hilbert(xr,n)
```

Description

`x = hilbert(xr)` returns a complex helical sequence, sometimes called the *analytic signal*, from a real data sequence. The analytic signal $x = x_r + i \cdot x_i$ has a real part, `xr`, which is the original data, and an imaginary part, `xi`, which contains the Hilbert transform. The imaginary part is a version of the original real sequence with a 90° phase shift. Sines are therefore transformed to cosines and conversely. The Hilbert transformed series has the same amplitude and frequency content as the original sequence and includes phase information that depends on the phase of the original.

If `xr` is a matrix, `x = hilbert(xr)` operates columnwise on the matrix, finding the analytic signal corresponding to each column.

`x = hilbert(xr,n)` uses an `n` point FFT to compute the Hilbert transform. The input data `xr` is zero-padded or truncated to length `n`, as appropriate.

The Hilbert transform is useful in calculating instantaneous attributes of a time series, especially the amplitude and frequency. The instantaneous amplitude is the amplitude of the complex Hilbert transform; the instantaneous frequency is the time rate of change of the instantaneous phase angle. For a pure sinusoid, the instantaneous amplitude and frequency are constant. The instantaneous phase, however, is a sawtooth, reflecting how the local phase angle varies linearly over a single cycle. For mixtures of sinusoids, the attributes are short term, or local, averages spanning no more than two or three points. See “Hilbert Transform and Instantaneous Frequency” for examples.

Reference [1] describes the Kolmogorov method for minimum phase reconstruction, which involves taking the Hilbert transform of the logarithm of the spectral density of a time series. The toolbox function `rceps` performs this reconstruction.

For a discrete-time analytic signal, x , the last half of `fft(x)` is zero, and the first (DC) and center (Nyquist) elements of `fft(x)` are purely real.

Examples

Analytic Signal of a Sequence

Define a sequence and compute its analytic signal using `hilbert`.

```
xr = [1 2 3 4];  
x = hilbert(xr)
```

```
x =  
    1.0000 + 1.0000i    2.0000 - 1.0000i    3.0000 - 1.0000i    4.0000 + 1.0000i
```

The imaginary part of x is the Hilbert transform of xr , and the real part is xr itself.

```
imx = imag(x)
```

```
imx =  
     1     -1     -1     1
```

```
rex = real(x)
```

```
rex =  
     1     2     3     4
```

The last half of the DFT of x is zero. (In this example, the last half of the transform is just the last element.) The DC and Nyquist elements of `fft(x)` are purely real.

```
dft = fft(x)
```

```
dft =  
    10.0000 + 0.0000i   -4.0000 + 4.0000i   -2.0000 + 0.0000i    0.0000 + 0.0000i
```

Analytic Signal and Hilbert Transform

The `hilbert` function finds the exact analytic signal for a finite block of data. You can also generate the analytic signal by using an FIR Hilbert transformer filter to compute an approximation to the imaginary part.

Generate a sequence composed of three sinusoids with frequencies 203, 721, and 1001 Hz. The sequence is sampled at 10 kHz for about 1 second. Use the `hilbert` function to compute the analytic signal. Plot it between 0.01 seconds and 0.03 seconds.

```
fs = 1e4;
t = 0:1/fs:1;

x = 2.5+cos(2*pi*203*t)+sin(2*pi*721*t)+cos(2*pi*1001*t);

y = hilbert(x);

plot(t,real(y),t,imag(y))
xlim([0.01 0.03])
legend('real','imaginary')
title('hilbert Function')
```

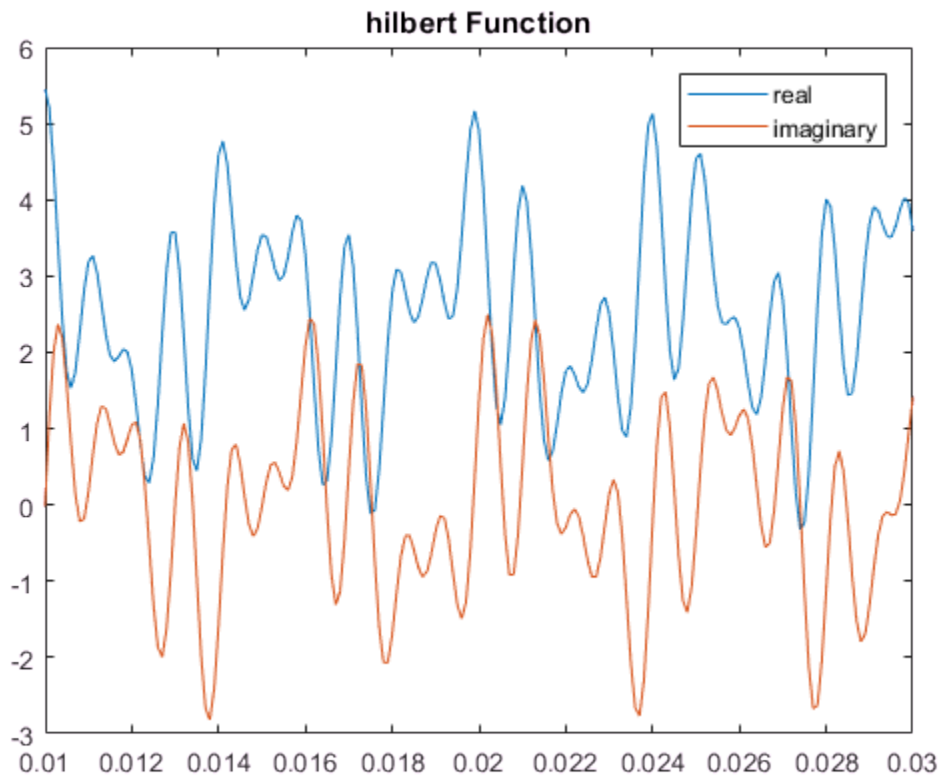

Compute Welch estimates of the power spectral densities of the original sequence and the analytic signal. Divide the sequences into Hamming windowed nonoverlapping sections of length 256. Verify that the analytic signal has no power at negative frequencies.

```
pwelch([x;y].',256,0,[],fs,'centered')
legend('Original','hilbert')
```

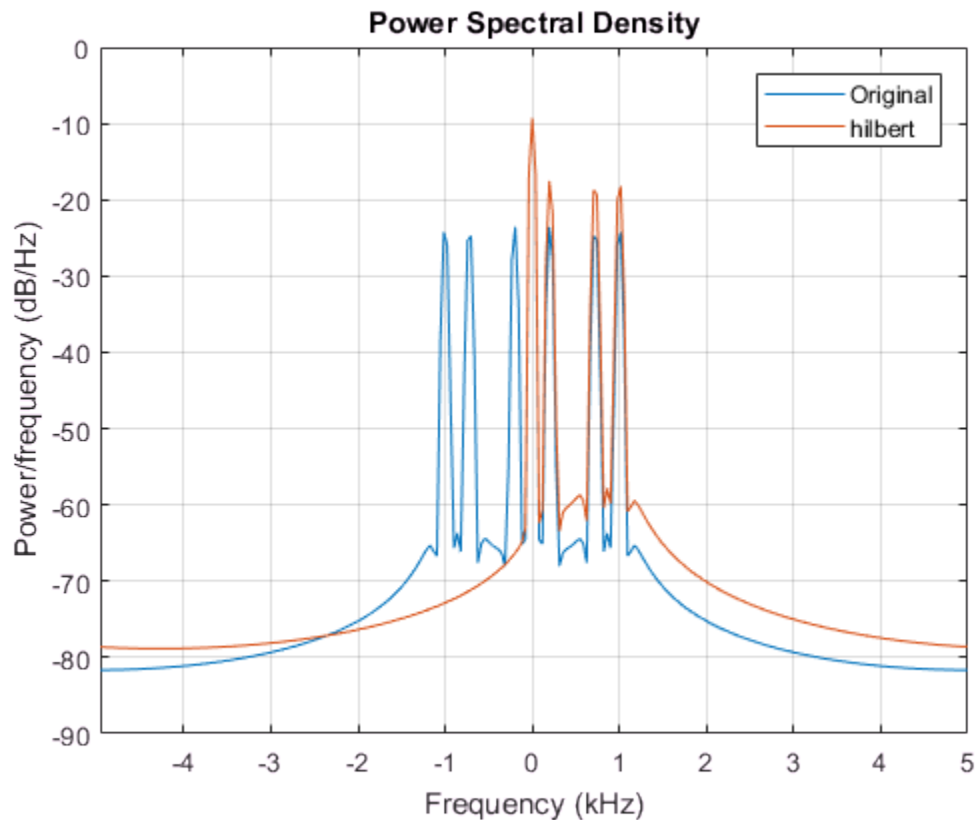

Use the `designfilt` function to design a 60th-order Hilbert transformer FIR filter. Specify a transition width of 400 Hz. Visualize the frequency response of the filter. Filter the sinusoidal sequence to approximate the imaginary part of the analytic signal.

```
fo = 60;
```

```
d = designfilt('hilbertfir','FilterOrder',fo, ...
              'TransitionWidth',400,'SampleRate',fs);
```

```
freqz(d,1024,fs)
```

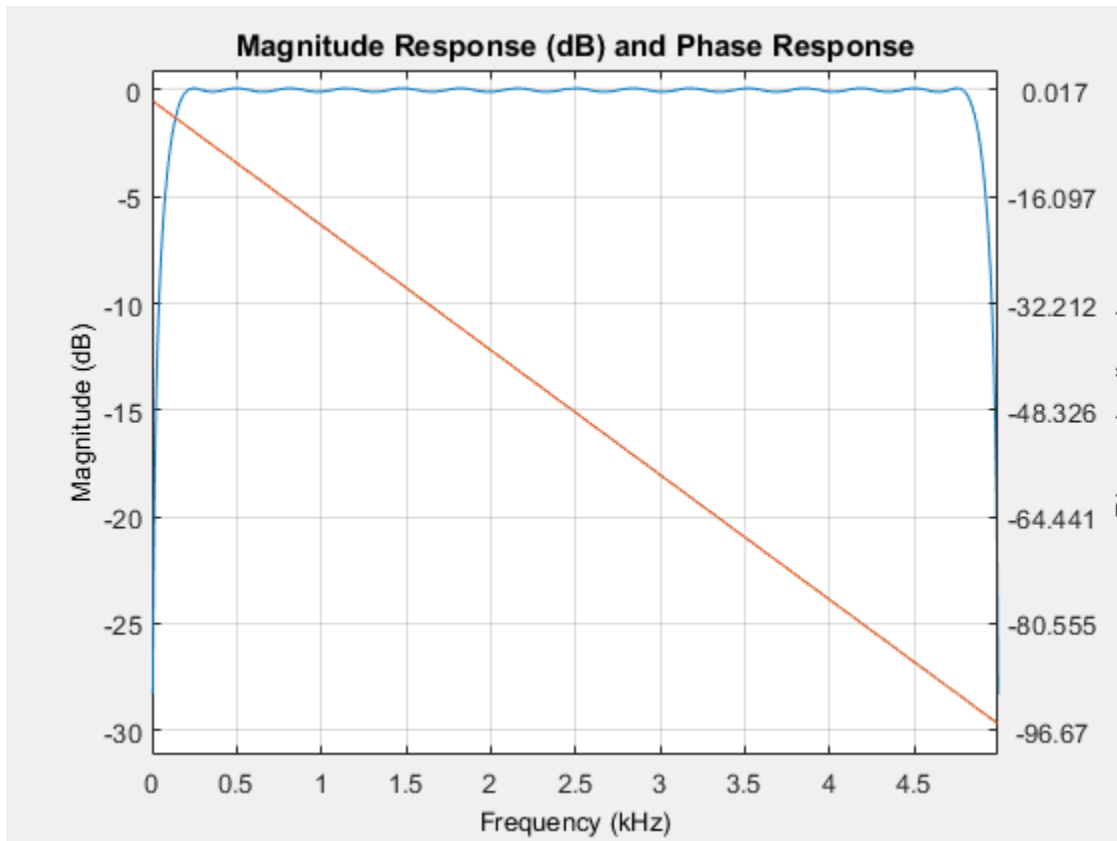

```
hb = filter(d,x);
```

The group delay of the filter, `grd`, is equal to one-half the filter order. Compensate for this delay. Remove the first `grd` samples of the imaginary part and the last `grd` samples of the real part and the time vector. Plot the result between 0.01 seconds and 0.03 seconds.

```
grd = fo/2;
```

```
y2 = x(1:end-grd) + 1j*hb(grd+1:end);
t2 = t(1:end-grd);
```



```

plot(t2,real(y2),t2,imag(y2))
xlim([0.01 0.03])
legend('real','imaginary')
title('FIR Filter')

```

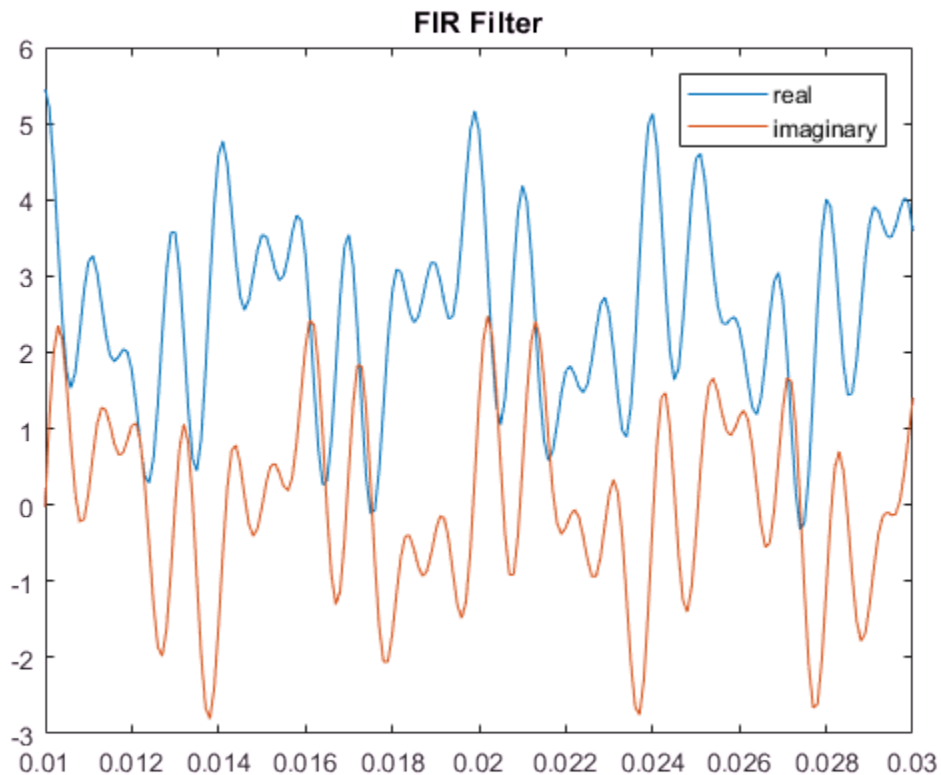

Estimate the PSD of the approximate analytic signal and compare it to the `hilbert` result.

```

pwelch([y;[y2 zeros(1,grd)]]',256,0,[],fs,'centered')
legend('hilbert','FIR Filter')

```

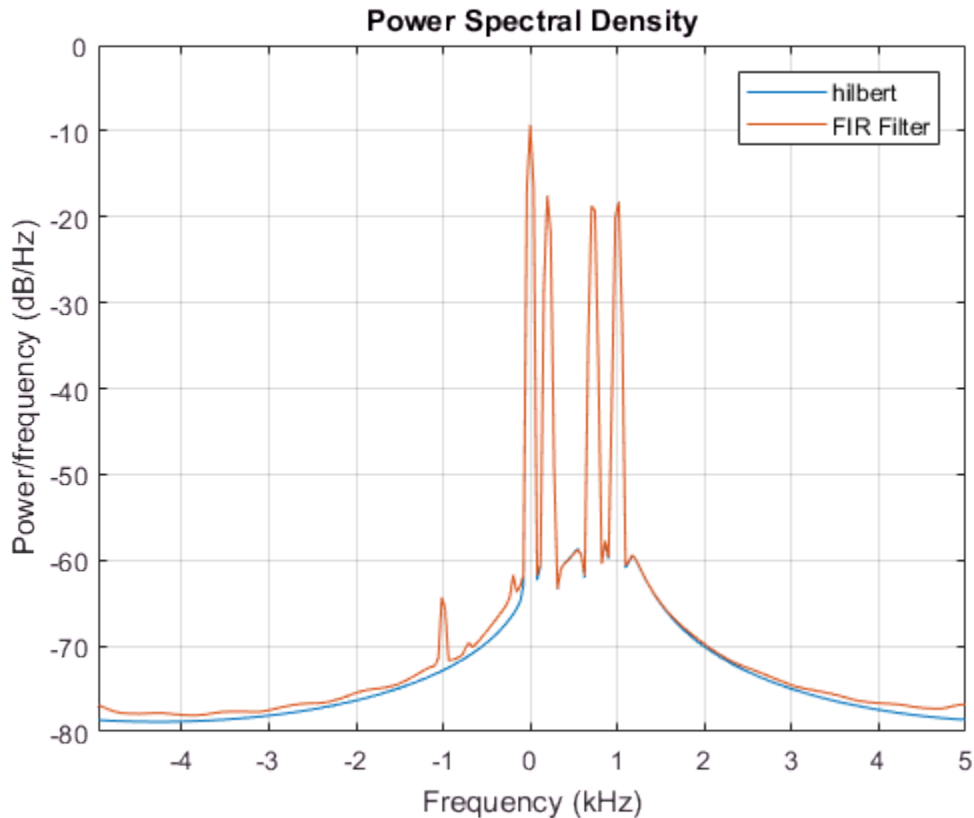

Algorithms

The analytic signal for a sequence x has a *one-sided Fourier transform*. That is, the transform vanishes for negative frequencies. To approximate the analytic signal, `hilbert` calculates the FFT of the input sequence, replaces those FFT coefficients that correspond to negative frequencies with zeros, and calculates the inverse FFT of the result.

In detail, `hilbert` uses a four-step algorithm:

- 1 It calculates the FFT of the input sequence, storing the result in a vector x .

- 2 It creates a vector h whose elements $h(i)$ have the values:
 - 1 for $i = 1, (n/2)+1$
 - 2 for $i = 2, 3, \dots, (n/2)$
 - 0 for $i = (n/2)+2, \dots, n$
- 3 It calculates the element-wise product of x and h .
- 4 It calculates the inverse FFT of the sequence obtained in step 3 and returns the first n elements of the result.

This algorithm was first introduced in [2]. The technique assumes that the input signal, x , is a finite block of data. This assumption allows the function to remove the spectral redundancy in x exactly. Methods based on FIR filtering can only approximate the analytic signal, but they have the advantage that they operate continuously on the data. See “Single-Sideband Amplitude Modulation” for another example of a Hilbert transform computed with an FIR filter.

References

- [1] Claerbout, Jon F. *Fundamentals of Geophysical Data Processing with Applications to Petroleum Prospecting*. Oxford, UK: Blackwell, 1985, pp. 59–62.
- [2] Marple, S. L. “Computing the Discrete-Time Analytic Signal via FFT.” *IEEE Transactions on Signal Processing*. Vol. 47, 1999, pp. 2600–2603.
- [3] Oppenheim, Alan V., Ronald W. Schaffer, and John R. Buck. *Discrete-Time Signal Processing*. 2nd Ed. Upper Saddle River, NJ: Prentice Hall, 1999.

Extended Capabilities

C/C++ Code Generation

Generate C and C++ code using MATLAB® Coder™.

See Also

See Also

fft | ifft | rceps

Introduced before R2006a

icceps

Inverse complex cepstrum

Syntax

```
x = icceps(xhat,nd)
```

Description

Note `icceps` only works on real data.

`x = icceps(xhat,nd)` returns the inverse complex cepstrum of the real data sequence `xhat`, removing `nd` samples of delay. If `xhat` was obtained with `cceps(x)`, then the amount of delay that was added to `x` was the element of `round(unwrap(angle(fft(x)))/pi)` corresponding to π radians.

References

[1] Oppenheim, A.V., and R.W. Schaffer, *Discrete-Time Signal Processing*, Prentice-Hall, 1989.

See Also

`cceps` | `hilbert` | `rceps` | `unwrap`

Introduced before R2006a

idct

Inverse discrete cosine transform

Syntax

```
x = idct(y)
x = idct(y,n)

x = idct(y,n,dim)

y = dct( ____, 'Type', dcttype)
```

Description

`x = idct(y)` returns the inverse discrete cosine transform of input array `y`. The output `x` has the same size as `y`. If `y` has more than one dimension, then `idct` operates along the first array dimension with size greater than 1.

`x = idct(y,n)` zero-pads or truncates the relevant dimension of `y` to length `n` before transforming.

`x = idct(y,n,dim)` computes the transform along dimension `dim`. To input a dimension and use the default value of `n`, specify the second argument as empty, `[]`.

`y = dct(____, 'Type', dcttype)` specifies the type of inverse discrete cosine transform to compute. See “Inverse Discrete Cosine Transform” on page 1-1085 for details. This option can be combined with any of the previous syntaxes.

Examples

Signal Reconstruction Using Inverse Discrete Cosine Transform

Generate a signal that consists of a 25 Hz sinusoid sampled at 1000 Hz for 1 second. The sinusoid is embedded in white Gaussian noise with variance 0.01.

```
rng('default')  
  
Fs = 1000;  
t = 0:1/Fs:1-1/Fs;  
x = sin(2*pi*25*t) + randn(size(t))/10;
```

Compute the discrete cosine transform of the sequence. Determine how many of the 1000 DCT coefficients are significant. Choose 1 as the threshold for significance.

```
y = dct(x);  
  
sigcoeff = abs(y) >= 1;  
  
howmany = sum(sigcoeff)  
  
howmany = 17
```

Reconstruct the signal using only the significant components.

```
y(~sigcoeff) = 0;  
  
z = idct(y);
```

Plot the original and reconstructed signals.

```
subplot(2,1,1)  
plot(t,x)  
yl = ylim;  
title('Original')  
  
subplot(2,1,2)  
plot(t,z)  
ylim(yl)  
title('Reconstructed')
```

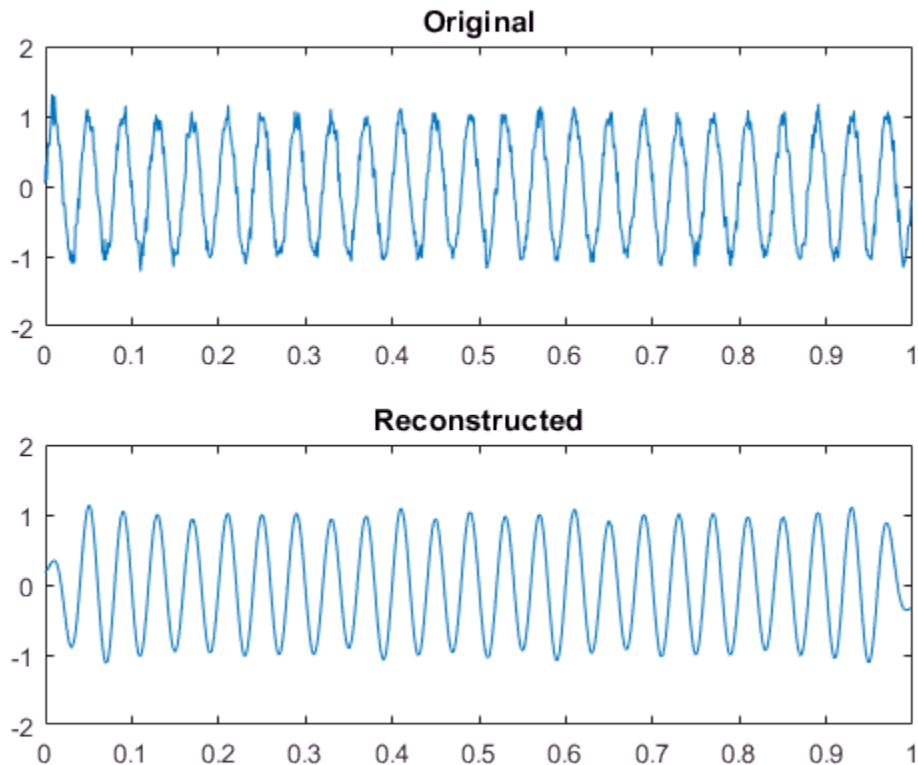

DCT Orthogonality

Verify that the different variants of the discrete cosine transform are orthogonal, using a random signal as a benchmark.

Start by generating the signal.

```
s = randn(1000,1);
```

Verify that DCT-1 and DCT-4 are their own inverses.

```
dct1 = dct(s, 'Type', 1);
```



```
idt1 = idct(s, 'Type', 1);  
max(abs(dct1-idt1))  
  
dct4 = dct(s, 'Type', 4);  
idt4 = idct(s, 'Type', 4);  
max(abs(dct4-idt4))
```

```
ans =  
  
1.1102e-15
```

```
ans =  
  
1.3323e-15
```

Verify that DCT-2 and DCT-3 are inverses of each other.

```
dct2 = dct(s, 'Type', 2);  
idt2 = idct(s, 'Type', 3);  
max(abs(dct2-idt2))  
  
dct3 = dct(s, 'Type', 3);  
idt3 = idct(s, 'Type', 2);  
max(abs(dct3-idt3))
```

```
ans =  
  
4.4409e-16
```

```
ans =  
  
1.5543e-15
```

- “DCT for Speech Signal Compression”

Input Arguments

y — Input discrete cosine transform

vector | matrix | N-D array | gpuArray object

Input discrete cosine transform, specified as a real-valued or complex-valued vector, matrix, N-D array, or `gpuArray` object.

See “GPU Computing” (Parallel Computing Toolbox) and GPU System Requirements for details on `gpuArray` objects.

Example: `dct(sin(2*pi*(0:255)/4))` specifies the discrete cosine transform of a sinusoid.

Example: `dct(sin(2*pi*[0.1;0.3]*(0:39))')` specifies the discrete cosine transform of a two-channel sinusoid.

Data Types: `single` | `double`

Complex Number Support: Yes

n — Inverse transform length

positive integer scalar

Inverse transform length, specified as a positive integer scalar.

Data Types: `single` | `double`

dim — Dimension to operate along

positive integer scalar

Dimension to operate along, specified as a positive integer scalar.

Data Types: `single` | `double`

dct type — Inverse discrete cosine transform type

2 (default) | 1 | 3 | 4

Inverse discrete cosine transform type, specified as a positive integer scalar from 1 to 4.

Data Types: `single` | `double`

Output Arguments

x — Inverse discrete cosine transform

vector | matrix | N-D array | gpuArray object

Inverse discrete cosine transform, returned as a real-valued or complex-valued vector, matrix, N-D array, or gpuArray object.

Definitions

Inverse Discrete Cosine Transform

The inverse discrete cosine transform reconstructs a sequence from its discrete cosine transform (DCT) coefficients. The `idct` function is the inverse of the `dct` function.

The DCT has four standard variants. For a transformed signal y of length N , and with $\delta_{k\ell}$ the Kronecker delta, the inverses are defined by:

- Inverse of DCT-1:

$$x(n) = \sqrt{\frac{2}{N}} \sum_{k=1}^N y(k) \frac{1}{\sqrt{1 + \delta_{k1} + \delta_{kN}}} \frac{1}{\sqrt{1 + \delta_{n1} + \delta_{nN}}} \cos\left(\frac{\pi}{N-1}(k-1)(n-1)\right)$$

- Inverse of DCT-2:

$$x(n) = \sqrt{\frac{2}{N}} \sum_{k=1}^N y(k) \frac{1}{\sqrt{1 + \delta_{n1}}} \cos\left(\frac{\pi}{2N}(2k-1)(n-1)\right)$$

- Inverse of DCT-3:

$$x(n) = \sqrt{\frac{2}{N}} \sum_{k=1}^N y(k) \frac{1}{\sqrt{1 + \delta_{k1}}} \cos\left(\frac{\pi}{2N}(k-1)(2n-1)\right)$$

- Inverse of DCT-4:

$$x(n) = \sqrt{\frac{2}{N}} \sum_{k=1}^N y(k) \cos\left(\frac{\pi}{4N}(2k-1)(2n-1)\right)$$

The series are indexed from $n = 1$ and $k = 1$ instead of the usual $n = 0$ and $k = 0$, because MATLAB vectors run from 1 to N instead of from 0 to $N - 1$.

All variants of the DCT are *unitary* (or, equivalently, *orthogonal*): To find the forward transforms, switch k and n in each definition. In particular, DCT-1 and DCT-4 are their own inverses, and DCT-2 and DCT-3 are inverses of each other.

References

- [1] Jain, A. K. *Fundamentals of Digital Image Processing*. Englewood Cliffs, NJ: Prentice-Hall, 1989.
- [2] Pennebaker, W. B., and J. L. Mitchell. *JPEG Still Image Data Compression Standard*. New York: Van Nostrand Reinhold, 1993.
- [3] Oppenheim, Alan V., Ronald W. Schaffer, and John R. Buck. *Discrete-Time Signal Processing*. 2nd Ed. Upper Saddle River, NJ: Prentice Hall, 1999.

Extended Capabilities

C/C++ Code Generation

Generate C and C++ code using MATLAB® Coder™.

Usage notes and limitations:

- C and C++ code generation for `dct` requires DSP System Toolbox software.
- The length of the transform dimension must be a power of two. If specified, the `pad` or `truncation` value must be constant. Expressions or variables are allowed if their values do not change.

See Also

See Also

`dct` | `dct2` | `idct2` | `ifft`

Topics

“DCT for Speech Signal Compression”

Introduced before R2006a

ifsst

Inverse Fourier synchrosqueezed transform

Syntax

```
x = ifsst(s)
```

```
x = ifsst(s,window)
```

```
x = ifsst(s,window,f,freqrange)
```

```
x = ifsst(s,window,iridge)
```

```
x = ifsst(s,window,iridge,'NumFrequencyBins',nbins)
```

Description

`x = ifsst(s)` returns the inverse Fourier synchrosqueezed transform of `s`. `x` is reconstructed using the entire time-frequency plane in `s`.

`x = ifsst(s,window)` reconstructs the signal whose Fourier synchrosqueezed transform was computed using `window`.

`x = ifsst(s,window,f,freqrange)` inverts the synchrosqueezed transform assuming it was sampled at the frequencies `f`, which lie within `freqrange`. The synchrosqueezed transform is inverted for the bins in `s` whose frequencies are within `freqrange`.

`x = ifsst(s,window,iridge)` inverts the synchrosqueezed transform along the time-frequency ridges specified by the index vector or matrix `iridge`. If `iridge` is a matrix, then `ifsst` initially performs the inversion along the first column of `iridge` and then proceeds iteratively along the subsequent columns. The output is a vector or matrix with the same size as `iridge`.

`x = ifsst(s,window,iridge,'NumFrequencyBins',nbins)` specifies the number of frequency bins around the indices in `iridge` to use in the reconstruction.

Examples

Inverse Fourier Synchrosqueezed Transform of Speech Signal

Load a speech signal sampled at $F_s = 7418$ Hz. The file contains a recording of a female voice saying the word "MATLAB®." Compute the Fourier synchrosqueezed transform of the signal.

```
load mtlb          % To hear, type sound(mtlb,Fs)

[sst,f] = fsst(mtlb,Fs);
```

Invert the transform to reconstruct the signal. Plot the original and reconstructed signals, as well as the difference between them.

```
xrec = ifsst(sst);

t = (0:length(mtlb)-1)/Fs;
plot(t,mtlb,t,xrec,t,mtlb-xrec)

xlabel('Time (s)')
legend('Original','Reconstructed','Difference')
```

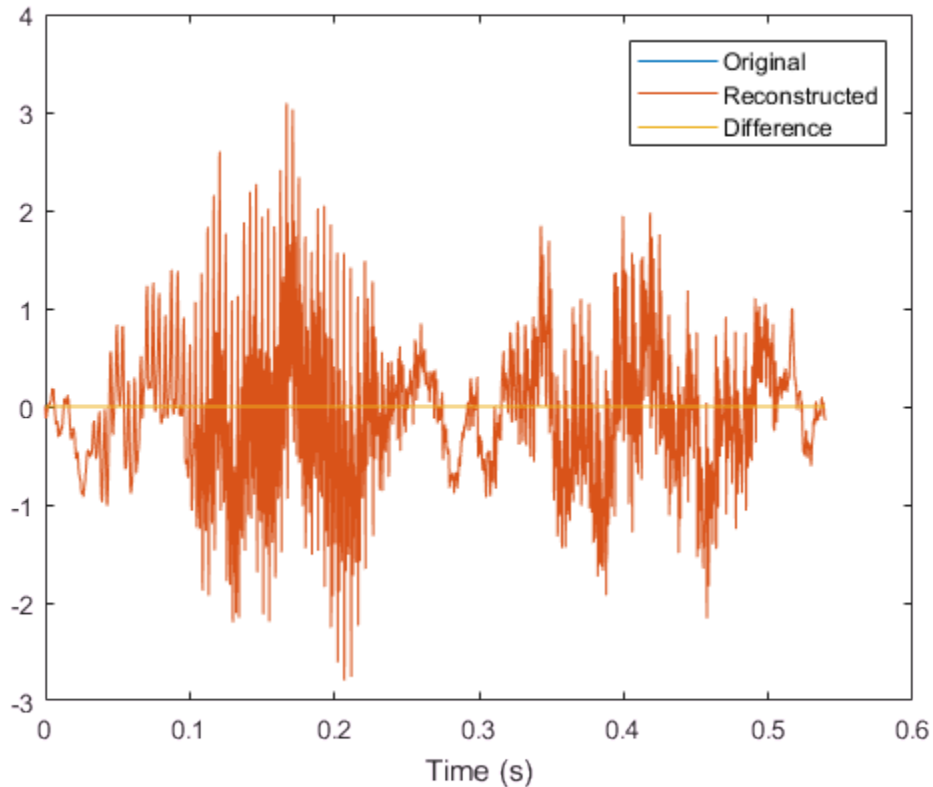

Check the accuracy of the reconstruction by computing the ℓ_∞ norm of the difference between the original signal and the inverse transform.

```
Linf = norm(abs(mtlb-xrec),Inf)
```

```
Linf = 1.9762e-14
```

```
% To hear, type sound(mtlb-xrec,Fs)
```

Fourier Synchrosqueezed Transform and Its Inverse

Generate a signal sampled at 1024 Hz for 2 seconds.

```
nSamp = 2048;
Fs = 1024;
t = (0:nSamp-1)'/Fs;
```

During the first second, the signal consists of a 400 Hz sinusoid and a concave quadratic chirp. Specify a chirp that is symmetric about the interval midpoint, starts and ends at a frequency of 250 Hz, and attains a minimum of 150 Hz.

```
t1 = t(1:nSamp/2);

x11 = sin(2*pi*400*t1);
x12 = chirp(t1-t1(nSamp/4), 150, nSamp/Fs, 1750, 'quadratic');
x1 = x11+x12;
```

The rest of the signal consists of two linear chirps of decreasing frequency. One chirp has an initial frequency of 250 Hz that decreases to 100 Hz. The other chirp has an initial frequency of 400 Hz that decreases to 250 Hz.

```
t2 = t(nSamp/2+1:nSamp);

x21 = chirp(t2, 400, nSamp/Fs, 100);
x22 = chirp(t2, 550, nSamp/Fs, 250);
x2 = x21+x22;
```

Compute the Fourier synchrosqueezed transform of the signal. Specify a 256-sample Kaiser window with a shape parameter $\beta = 100$. Use the plotting functionality of `fsst` to display the result.

```
sig = [x1;x2];
wind = kaiser(256, 120);

[sigtr, ftr, ttr] = fsst(sig, Fs, wind);

fsst(sig, Fs, wind, 'yaxis')
```

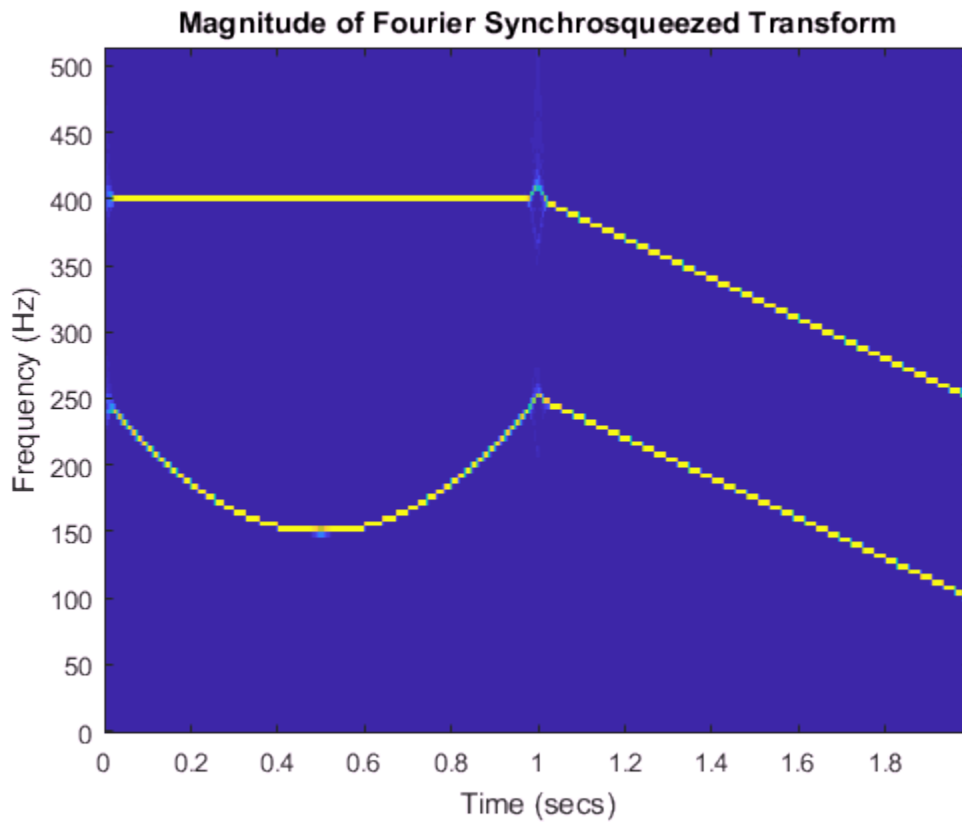

Invert the transform to reconstruct the function. Plot the original and inverted signals and the difference between them.

```
x = ifsst(sigtr,wind);

plot(t,sig,t,x,t,x-sig)
legend('Original','Reconstructed','Difference')
```

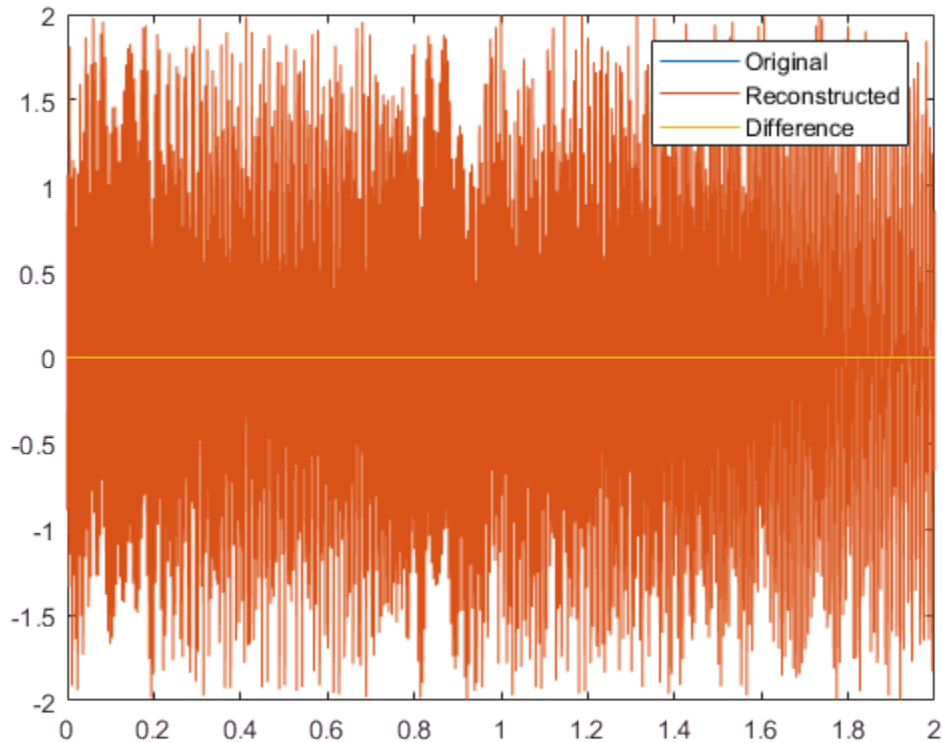

```
diffnorm = norm(x-sig)
```

```
diffnorm = 3.9030e-13
```

Reconstruction of Linear Chirps

Generate a signal that consists of two chirps. The signal is sampled at 3 kHz for one second. The first chirp has an initial frequency of 400 Hz and reaches 800 Hz at the end of the sampling. The second chirp starts at 500 Hz and reaches 1000 Hz at the end. The second chirp has twice the amplitude of the first chirp.

```
fs = 3000;  
t = 0:1/fs:1-1/fs;
```

```
x1 = chirp(t,400,t(end),800);
x2 = 2*chirp(t,500,t(end),1000);
```

Compute and plot the Fourier synchrosqueezed transform of the signal. Display the time on the x -axis and the frequency on the y -axis.

```
[sst,f] = fsst(x1+x2,fs);
fsst(x1+x2,fs,'yaxis')
```

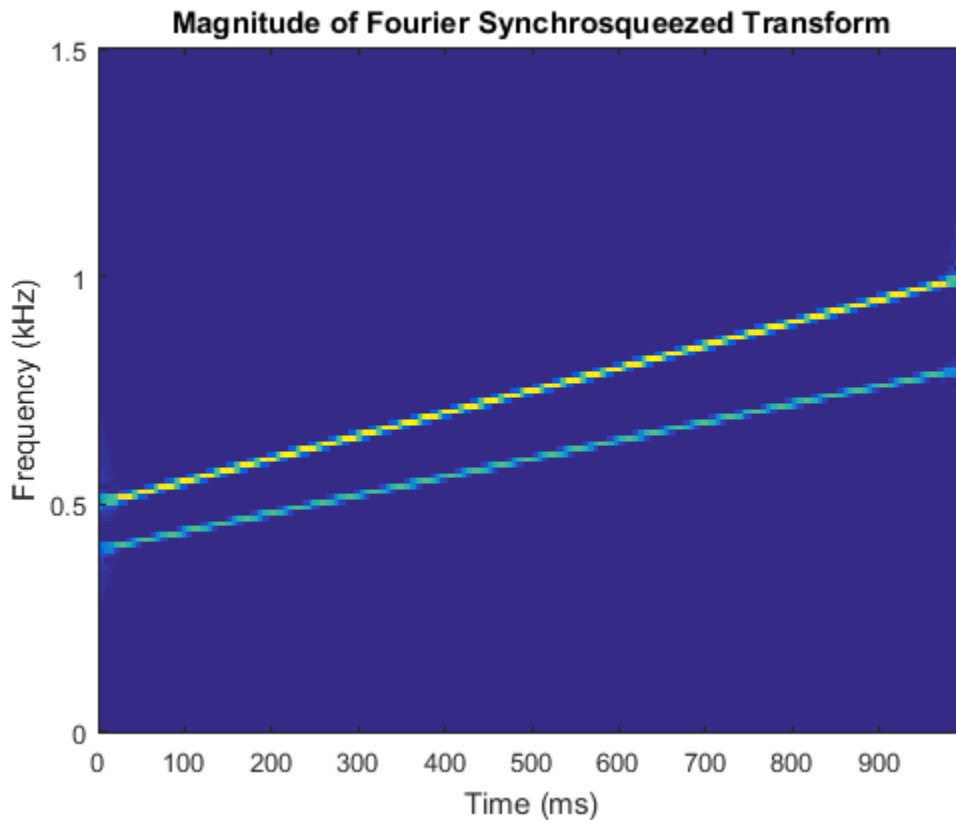

Extract the ridge corresponding to the higher-energy component of the signal, which is the chirp with the larger amplitude. Use the ridge to reconstruct the signal.

```
[~,iridge] = tfridge(sst,f);
```

```
xrec = ifsst(sst,[],iridge);
```

Plot the spectrogram for the higher-energy component. Divide the component into 256-sample sections and specify an overlap of 255 samples. Use 512 DFT points and a rectangular window.

```
spectrogram(xrec,rectwin(256),255,512,fs,'yaxis')
```

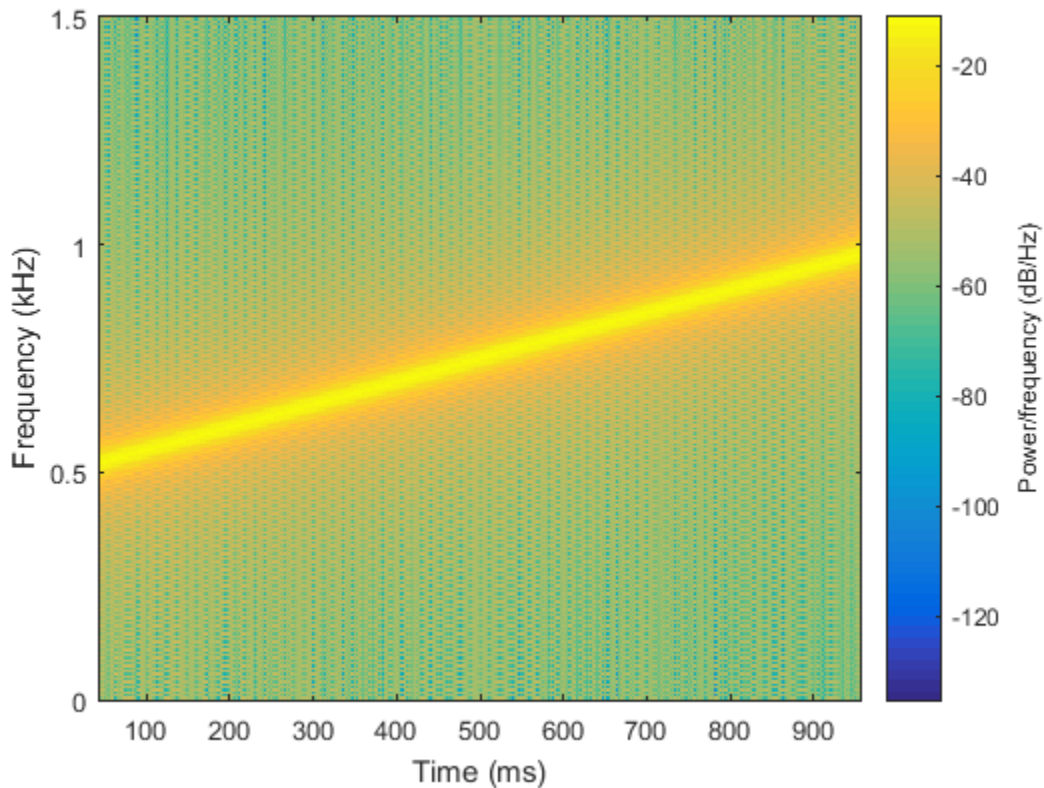

To extract the second chirp, specify that `tfridge` search for two ridges. The second column of the output is the lower-energy component of the signal.

```
[~,iridge] = tfridge(sst,f,'NumRidges',2);
```

```
xrec = ifsst(sst,[],iridge(:,2));  
spectrogram(xrec,rectwin(256),255,512,fs,'yaxis')
```

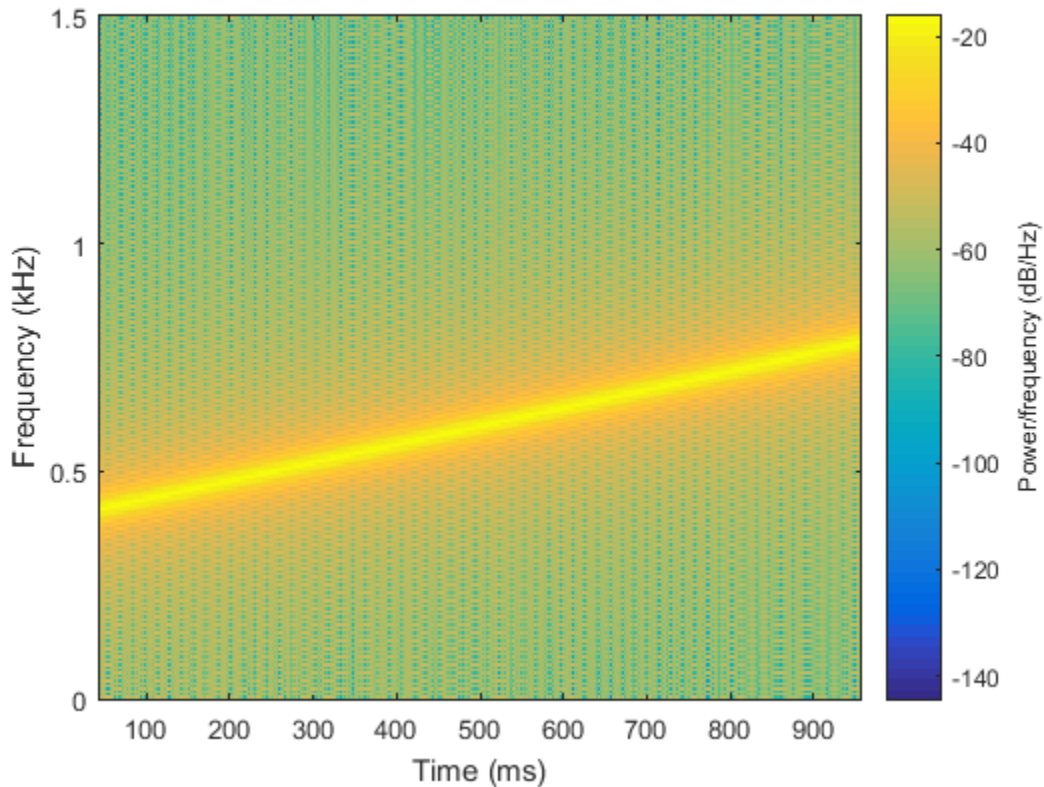

- “Hilbert Transform and Instantaneous Frequency”
- “Practical Introduction to Time-Frequency Analysis”
- “Detect Closely Spaced Sinusoids”

Input Arguments

s — Input synchrosqueezed transform matrix

Input synchrosqueezed transform, specified as a matrix.

Example: `fsst(cos(pi/4*(0:159)))` specifies the synchrosqueezed transform of a sinusoid.

Data Types: `single` | `double`

Complex Number Support: Yes

window — Spectral window

`kaiser(256,10)` (default) | `integer` | `vector` | `[]`

Spectral window, specified as an integer or as a row or column vector.

- If `window` is an integer, then `ifsst` assumes that the synchrosqueezed transform, `s`, was computed using a Kaiser window of length `window` and $\beta = 10$.
- If `window` is a vector, then `ifsst` assumes that `s` was computed by windowing each segment of the original signal using `window`.
- If `window` is not specified, then `ifsst` assumes that `s` was computed using a Kaiser window of length 256 and $\beta = 10$. If the signal to be reconstructed, `x`, has fewer than 256 samples, then you must provide a window length or window vector consistent with the length of `x`.

For a list of available windows, see “Windows”.

Example: `hann(N+1)` and `(1-cos(2*pi*(0:N)'/N))/2` both specify a Hann window of length `N + 1`.

Data Types: `double` | `single`

f — Sampling frequencies

`vector`

Sampling frequencies, specified as a vector. The length of `f` must equal the number of elements in `s`.

Data Types: `single` | `double`

freqrange — Frequency range

`two-element vector`

Frequency range, specified as a two-element vector. The values of `freqrange` must be strictly increasing and must lie in the range comprised by `f`.

Data Types: `single` | `double`

iridge — Time-frequency ridge indices

vector | matrix

Time-frequency ridge indices, specified as a vector or matrix. `iridge` is an output of `tfidge`.

Data Types: single | double

nbins — Number of neighboring bins

4 (default) | positive integer scalar

Number of neighboring bins on either side of the time-frequency ridges of interest, specified as the comma-separated pair consisting of 'NumFrequencyBins' and a positive integer scalar. Indices close to the frequency edges that have fewer than `nbins` bins on one side are reconstructed using a smaller number of bins.

Data Types: single | double

Output Arguments

x — Inverse synchrosqueezed transform

vector

Inverse synchrosqueezed transform, returned as a vector. The length of `x` equals the number of columns in `s`.

See Also

See Also

`fsst` | `spectrogram` | `tfidge`

Topics

“Hilbert Transform and Instantaneous Frequency”

“Practical Introduction to Time-Frequency Analysis”

“Detect Closely Spaced Sinusoids”

“Fourier Synchrosqueezed Transform” on page 1-992

Introduced in R2016b

ifwht

Inverse Fast Walsh-Hadamard transform

Syntax

```
y = ifwht(x)
y = ifwht(x,n)
y = ifwht(x,n,ordering)
```

Description

`y = ifwht(x)` returns the coefficients of the inverse discrete fast Walsh-Hadamard transform of the input `x`. If `x` is a matrix, the inverse fast Walsh-Hadamard transform is calculated on each column of `x`. The inverse fast Walsh-Hadamard transform operates only on signals with length equal to a power of 2. If the length of `x` is less than a power of 2, its length is padded with zeros to the next greater power of two before processing.

`y = ifwht(x,n)` returns the `n`-point inverse discrete Walsh-Hadamard transform, where `n` must be a power of 2.

`y = ifwht(x,n,ordering)` specifies the ordering to use for the returned inverse Walsh-Hadamard transform coefficients. To specify the ordering, you must enter a value for the length `n` or, to use the default behavior, specify an empty vector (`[]`) for `n`. Valid values for the ordering are the following:

Ordering	Description
'sequency'	Coefficients in order of ascending sequency value, where each row has an additional zero crossing. This is the default ordering.
'hadamard'	Coefficients in normal Hadamard order.
'dyadic'	Coefficients in Gray code order, where a single bit change occurs from one coefficient to the next.

Examples

Walsh-Hadamard Transform for Spectral Analysis and Compression of ECG Signals

Use an electrocardiogram (ECG) signal to illustrate working with the Walsh-Hadamard transform. ECG signals typically are very large and need to be stored for analysis and retrieval at a future time. Walsh-Hadamard transforms are particularly well-suited to this application because they provide compression and thus require less storage space. They also provide rapid signal reconstruction.

Start with an ECG signal. Replicate it to create a longer signal and insert some additional random noise.

```
xe = ecg(512);  
xr = repmat(xe,1,8);  
x = xr + 0.1.*randn(1,length(xr));
```

Transform the signal using the fast Walsh-Hadamard transform. Plot the original signal and the transformed signal.

```
y = fwht(x);  
  
subplot(2,1,1)  
plot(x)  
xlabel('Sample index')  
ylabel('Amplitude')  
title('ECG Signal')  
  
subplot(2,1,2)  
plot(abs(y))  
xlabel('Sequency index')  
ylabel('Magnitude')  
title('WHT Coefficients')
```

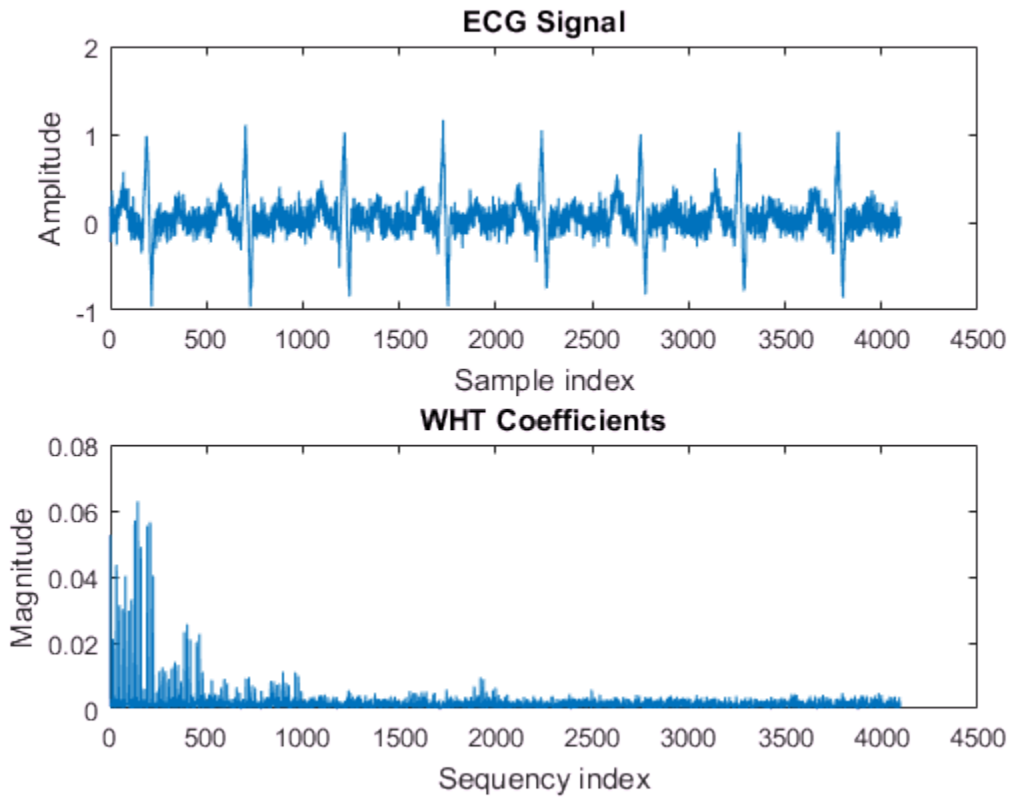

The plot shows that most of the signal energy is in the lower sequency values, below approximately 1100. Store only the first 1024 coefficients (out of 4096). Try to reconstruct the signal accurately from only these stored coefficients.

```
y(1025:length(x)) = 0;
xHat = ifwht(y);
```

```
figure
plot(x)
hold on
plot(xHat)
xlabel('Sample Index')
ylabel('ECG Signal Amplitude')
legend('Original', 'Reconstructed')
```

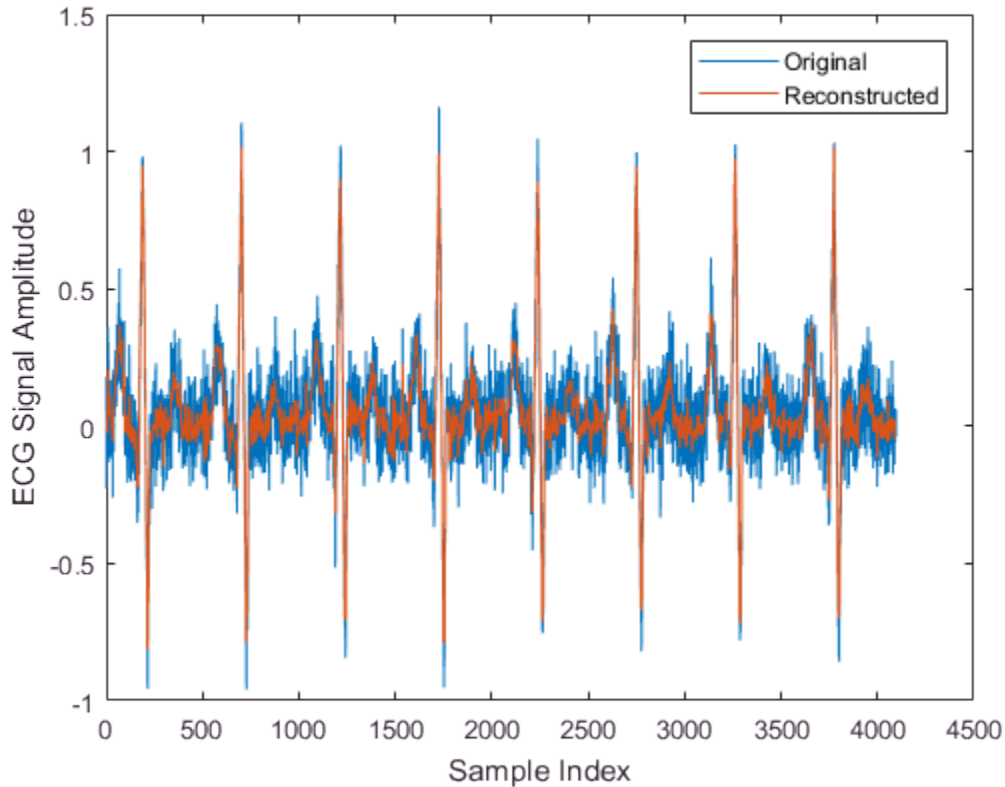

The reproduced signal is very close to the original but has been compressed to a quarter of the size. Storing more coefficients is a tradeoff between increased resolution and increased noise, while storing fewer coefficients can cause loss of peaks.

Algorithms

The inverse fast Walsh-Hadamard transform algorithm is similar to the Cooley-Tukey algorithm used for the inverse FFT. Both use a butterfly structure to determine the transform coefficients. See the references for details.

References

- [1] Beauchamp, Kenneth G. *Applications of Walsh and Related Functions: With an Introduction to Sequency Theory*. London: Academic Press, 1984.
- [2] Beer, Tom. "Walsh Transforms." *American Journal of Physics*. Vol. 49, 1981, pp.466–472.

See Also

fwht | dct | idct | fft | ifft

Introduced in R2008b

impinvar

Impulse invariance method for analog-to-digital filter conversion

Syntax

```
[bz,az] = impinvar(b,a,fs)
[bz,az] = impinvar(b,a,fs,tol)
```

Description

`[bz,az] = impinvar(b,a,fs)` creates a digital filter with numerator and denominator coefficients `bz` and `az`, respectively, whose impulse response is equal to the impulse response of the analog filter with coefficients `b` and `a`, scaled by $1/fs$. If you leave out the argument `fs`, or specify `fs` as the empty vector `[]`, it takes the default value of 1 Hz.

`[bz,az] = impinvar(b,a,fs,tol)` uses the tolerance specified by `tol` to determine whether poles are repeated. A larger tolerance increases the likelihood that `impinvar` interprets closely located poles as multiplicities (repeated ones). The default is 0.001, or 0.1% of a pole's magnitude. The accuracy of the pole values is still limited to the accuracy obtainable by the `roots` function.

Examples

Analog and Digital Butterworth Filters

Convert a sixth-order analog Butterworth lowpass filter to a digital filter using impulse invariance. Specify a sample rate of 10 Hz and a cutoff frequency of 2 Hz. Display the frequency response of the filter.

```
f = 2;
fs = 10;

[b,a] = butter(6,2*pi*f,'s');
[bz,az] = impinvar(b,a,fs);

freqz(bz,az,1024,fs)
```

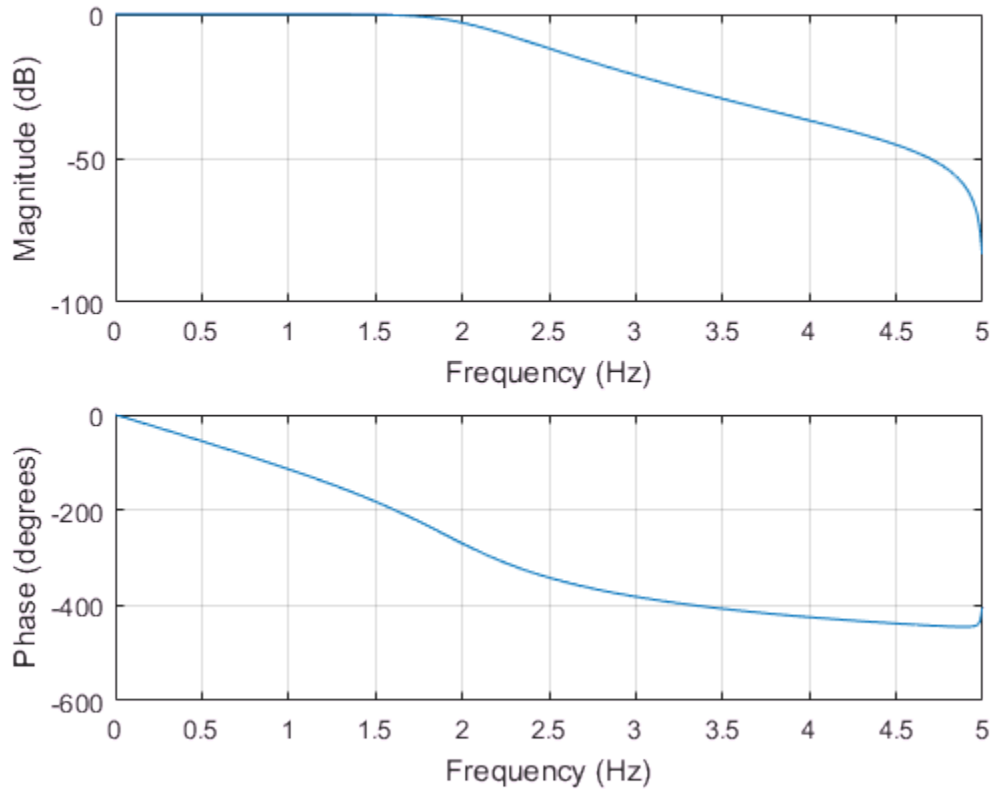

Analog and Digital Impulse Responses

Convert a fourth-order analog elliptic filter to a digital filter using impulse invariance.

Specify a sample rate $f_s = 10$ Hz, a passband edge frequency of 2.5 Hz, a passband ripple of 1 dB, and a stopband attenuation of 60 dB. Display the impulse response of the digital filter.

```
fs = 10;
```

```
[b,a] = ellip(3,1,60,2*pi*2.5, 's');
[bz,az] =impinvar(b,a,fs);
```

`impz(bz,az,[],fs)`

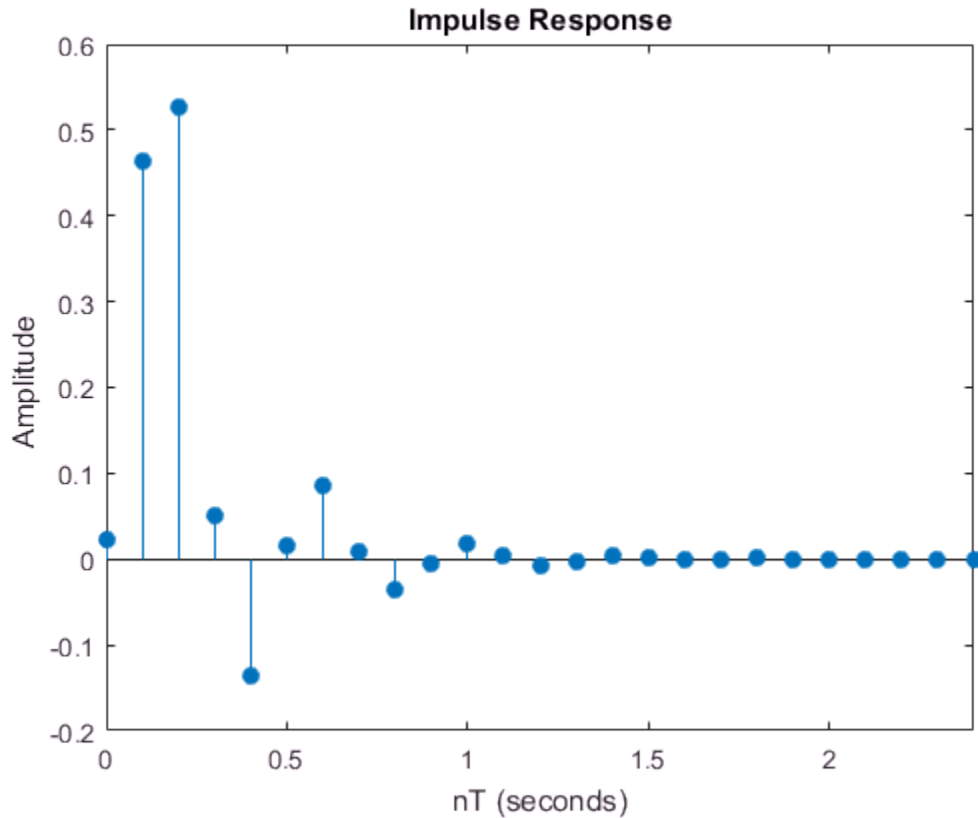

Derive the impulse response of the analog filter by finding the residues, r_k , and poles, p_k , of the transfer function and inverting the Laplace transform explicitly using

$$H(s) = \sum_k \frac{r_k}{s - p_k} \Leftrightarrow h(t) = \sum_k r_k e^{p_k t}.$$

Overlay the impulse response of the analog filter. Impulse invariance introduces a gain of $1/f_s$ to the digital filter. Multiply the analog impulse response by this gain to enable meaningful comparison.

```
[r,p] = residue(b,a);
t = linspace(0,4,1000);
h = real(r.'*exp(p.*t)/fs);
```

```
hold on
plot(t,h)
hold off
```

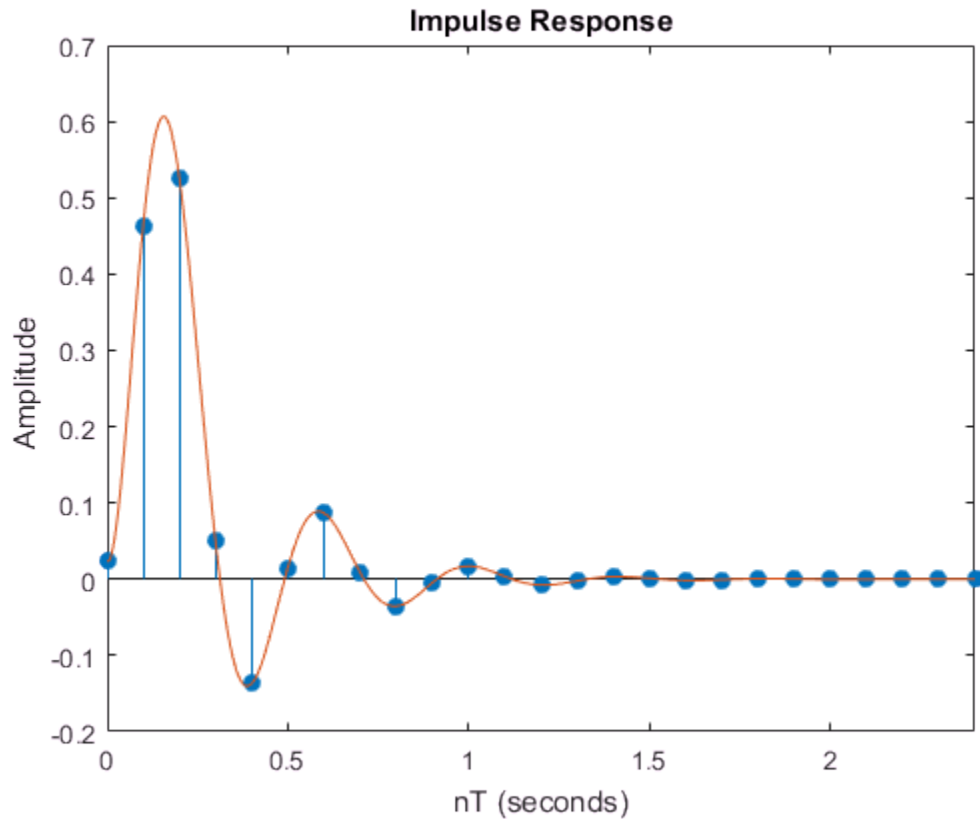

Algorithms

`impinvar` performs the impulse-invariant method of analog-to-digital transfer function conversion discussed in reference [1]:

- 1** It finds the partial fraction expansion of the system represented by **b** and **a**.
- 2** It replaces the poles **p** by the poles $\exp(p/fs)$.
- 3** It finds the transfer function coefficients of the system from the residues from step 1 and the poles from step 2.

References

[1] Parks, Thomas W., and C. Sidney Burrus. *Digital Filter Design*. New York: John Wiley & Sons, 1987.

[2] Antoniou, Andreas. *Digital Filters*. New York: McGraw-Hill, Inc., 1993.

See Also

bilinear | lp2bp | lp2bs | lp2hp | lp2lp

Introduced before R2006a

impz

Impulse response of digital filter

Syntax

```
[h,t] = impz(b,a)
[h,t] = impz(sos)
[h,t] = impz(d)
[h,t] = impz(...,n)
[h,t] = impz(...,n,fs)
impz(...)
```

Description

`[h,t] = impz(b,a)` returns the impulse response of the filter with numerator coefficients, `b`, and denominator coefficients, `a`. `impz` chooses the number of samples and returns the response in the column vector, `h`, and the sample times in the column vector, `t`. `t = [0:n-1]'` and `n = length(t)` is computed automatically.

`[h,t] = impz(sos)` returns the impulse response for the second-order sections matrix, `sos`. `sos` is a K -by-6 matrix, where the number of sections, K , must be greater than or equal to 2. If the number of sections is less than 2, `impz` considers the input to be a numerator vector. Each row of `sos` corresponds to the coefficients of a second order (biquad) filter. The i th row of the `sos` matrix corresponds to `[bi(1) bi(2) bi(3) ai(1) ai(2) ai(3)]`.

`[h,t] = impz(d)` returns the impulse response of a digital filter, `d`. Use `designfilt` to generate `d` based on frequency-response specifications.

`[h,t] = impz(...,n)` computes `n` samples of the impulse response when `n` is an integer (`t = [0:n-1]'`). If `n` is a vector of integers, `impz` computes the impulse response at those integer locations, starting the response computation from 0 (and `t = n` or `t = [0 n]`). If, instead of `n`, you include the empty vector, `[]`, for the second argument, the number of samples is computed automatically.

`[h,t] = impz(...,n,fs)` computes `n` samples and produces a vector `t` of length `n` so that the samples are spaced `1/fs` units apart.

`impz(...)` with no output arguments plots the impulse response of the filter.

`impz` works for both real and complex input systems.

Note: If the input to `impz` is single precision, the impulse response is calculated using single-precision arithmetic. The output, `h`, is single precision.

Examples

Impulse Response of an Elliptic Lowpass Filter

Design a fourth-order lowpass elliptic filter with normalized passband frequency 0.4. Specify a passband ripple of 0.5 dB and a stopband attenuation of 20 dB. Plot the first 50 samples of the impulse response.

```
[b,a] = ellip(4,0.5,20,0.4);  
impz(b,a,50)
```

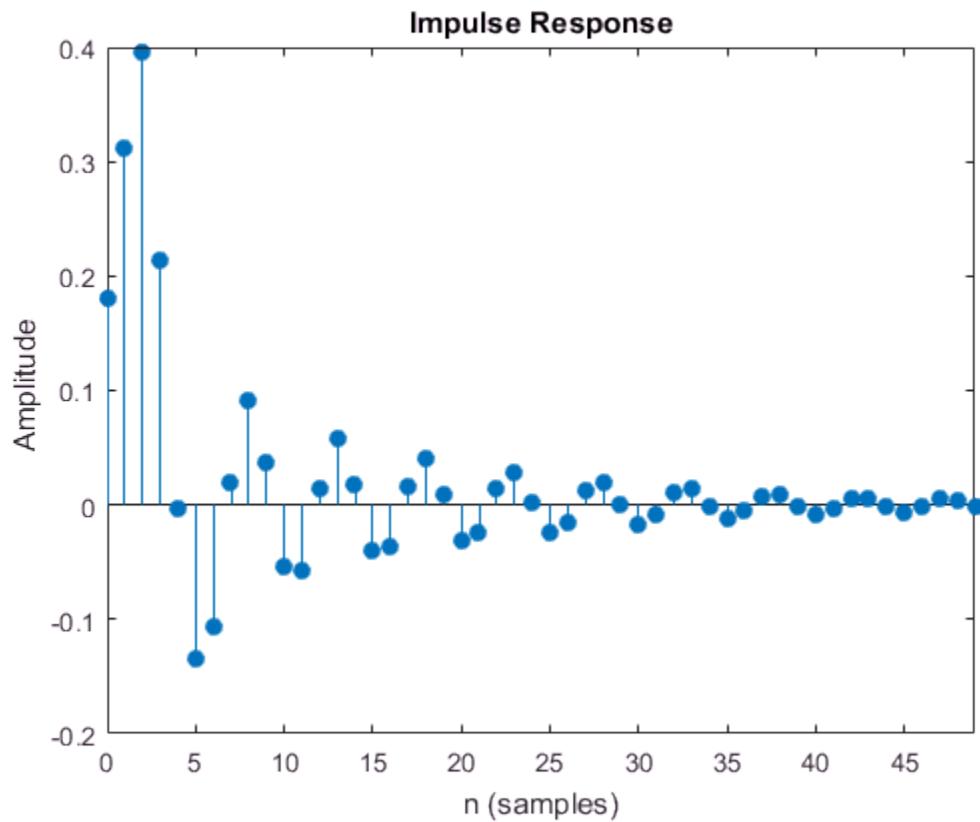

Design the same filter using `designfilt`. Plot the first 50 samples of its impulse response.

```
d = designfilt('lowpassiir','DesignMethod','ellip','FilterOrder',4, ...  
              'PassbandFrequency',0.4, ...  
              'PassbandRipple',0.5,'StopbandAttenuation',20);  
impz(d,50)
```

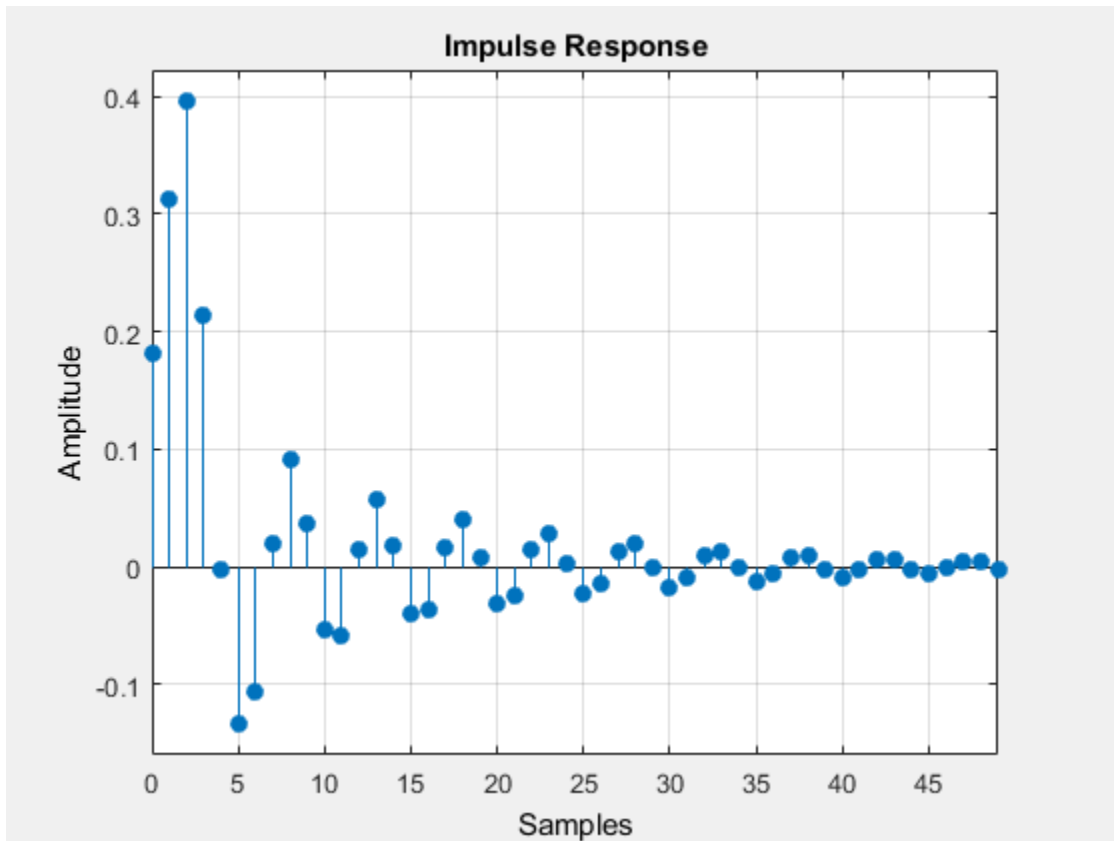

Impulse Response of a Highpass FIR Filter

Design an FIR highpass filter of order 18 using a Kaiser window with $\beta = 4$. Specify a sampling rate of 100 Hz and a cutoff frequency of 30 Hz. Display the impulse response of the filter.

```
b = fir1(18,30/(100/2),'high',kaiser(19,4));  
impz(b,1,[],100)
```

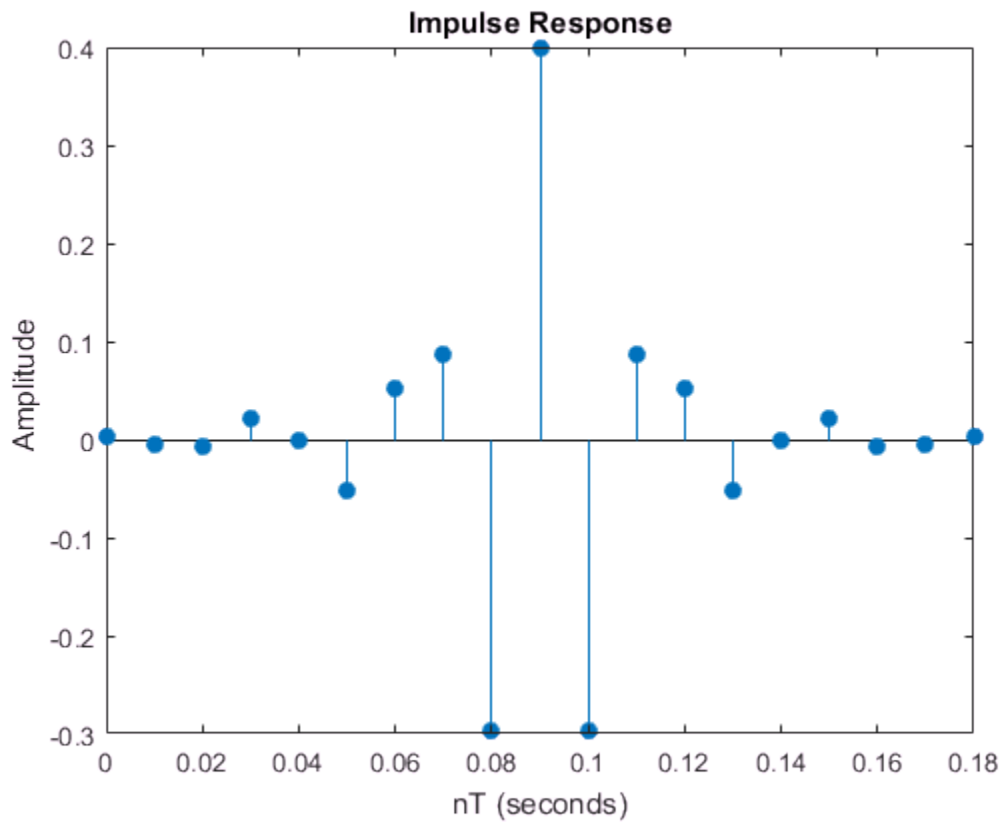

Design the same filter using `designfilt` and plot its impulse response.

```
d = designfilt('highpassfir', 'FilterOrder', 18, 'SampleRate', 100, ...  
              'CutoffFrequency', 30, 'Window', {'kaiser', 4});  
impz(d, [], 100)
```

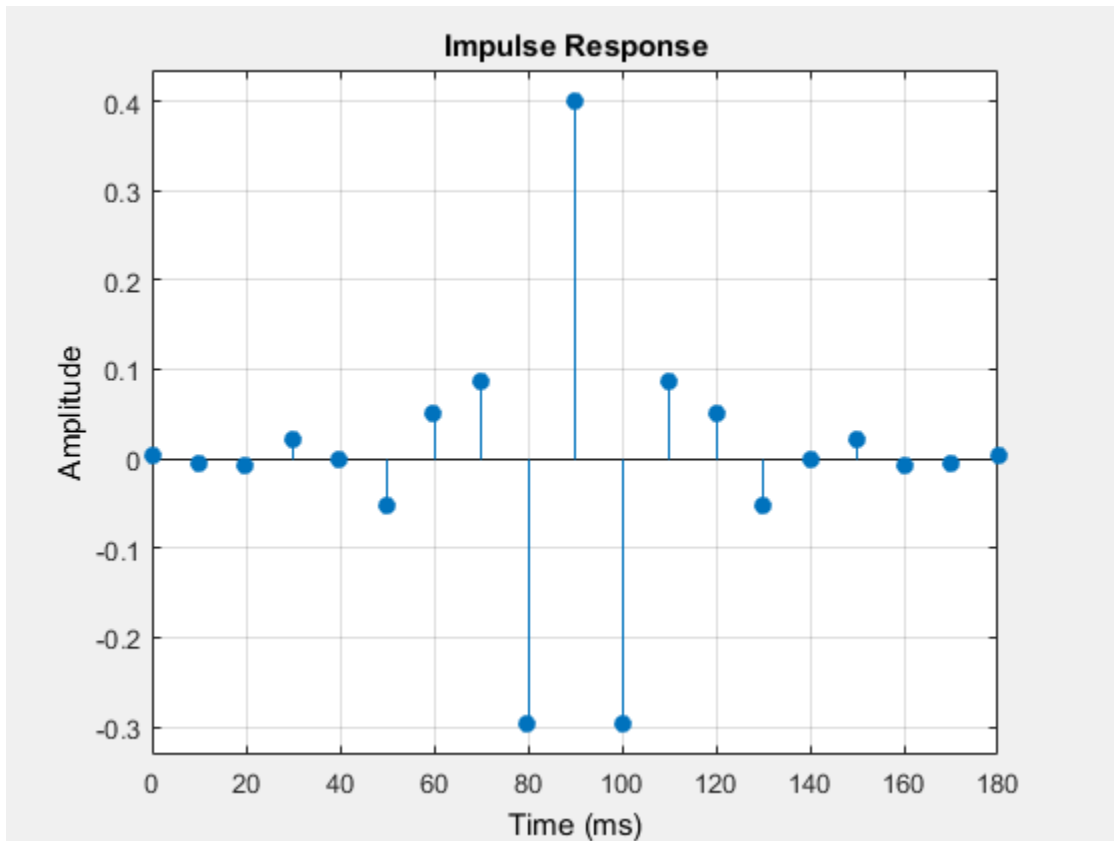

Algorithms

`impz` filters a length `n` impulse sequence using

```
filter(b,a,[1 zeros(1,n-1)])
```

and plots the results using `stem`.

To compute `n` in the auto-length case, `impz` either uses `n = length(b)` for the FIR case or first finds the poles using `p = roots(a)`, if `length(a)` is greater than 1.

If the filter is unstable, `n` is chosen to be the point at which the term from the largest pole reaches 10^6 times its original value.

If the filter is stable, `n` is chosen to be the point at which the term due to the largest amplitude pole is 5×10^{-5} of its original amplitude.

If the filter is oscillatory (poles on the unit circle only), `impz` computes five periods of the slowest oscillation.

If the filter has both oscillatory and damped terms, `n` is chosen to equal five periods of the slowest oscillation or the point at which the term due to the pole of largest nonunit amplitude is 5×10^{-5} of its original amplitude, whichever is greater.

`impz` also allows for delays in the numerator polynomial. The number of delays is incorporated into the computation for the number of samples.

See Also

`designfilt` | `digitalFilter` | `impulse` | `stem`

Introduced before R2006a

impzlength

Impulse response length

Syntax

```
len = impzlength(b,a)
len = impzlength(sos)
len = impzlength(d)

len = impzlength(hd)

len = impzlength( ____,tol)
```

Description

`len = impzlength(b,a)` returns the impulse response length for the causal discrete-time filter with the rational system function specified by the numerator, **b**, and denominator, **a**, polynomials in z^{-1} . For stable IIR filters, **len** is the effective impulse response sequence length. Terms in the IIR filter's impulse response after the **len**-th term are essentially zero.

`len = impzlength(sos)` returns the effective impulse response length for the IIR filter specified by the second order sections matrix, **sos**. **sos** is a K -by-6 matrix, where the number of sections, K , must be greater than or equal to 2. If the number of sections is less than 2, `impzlength` considers the input to be the numerator vector, **b**. Each row of **sos** corresponds to the coefficients of a second order (biquad) filter. The i th row of the **sos** matrix corresponds to `[bi(1) bi(2) bi(3) ai(1) ai(2) ai(3)]`.

`len = impzlength(d)` returns the impulse response length for the digital filter, **d**. Use `designfilt` to generate **d** based on frequency-response specifications.

`len = impzlength(hd)` returns the impulse response length for the `dfilt` filter object, **hd**. You can also input an array of filter objects. If **hd** is an array of filter objects, each column of **len** is the impulse response length of the corresponding filter object.

`len = impzlength(____,tol)` specifies a tolerance for estimating the effective length of an IIR filter's impulse response. By default, **tol** is `5e-5`. Increasing the value of **tol**

estimates a shorter effective length for an IIR filter's impulse response. Decreasing the value of `tol` produces a longer effective length for an IIR filter's impulse response.

Examples

IIR Filter Effective Impulse Response Length — Coefficients

Create a lowpass allpole IIR filter with a pole at 0.9. Calculate the effective impulse response length. Obtain the impulse response. Plot the result.

```
b = 1;  
a = [1 -0.9];  
len = impzlength(b,a)
```

```
len = 93
```

```
[h,t] = impz(b,a);  
stem(t,h)
```

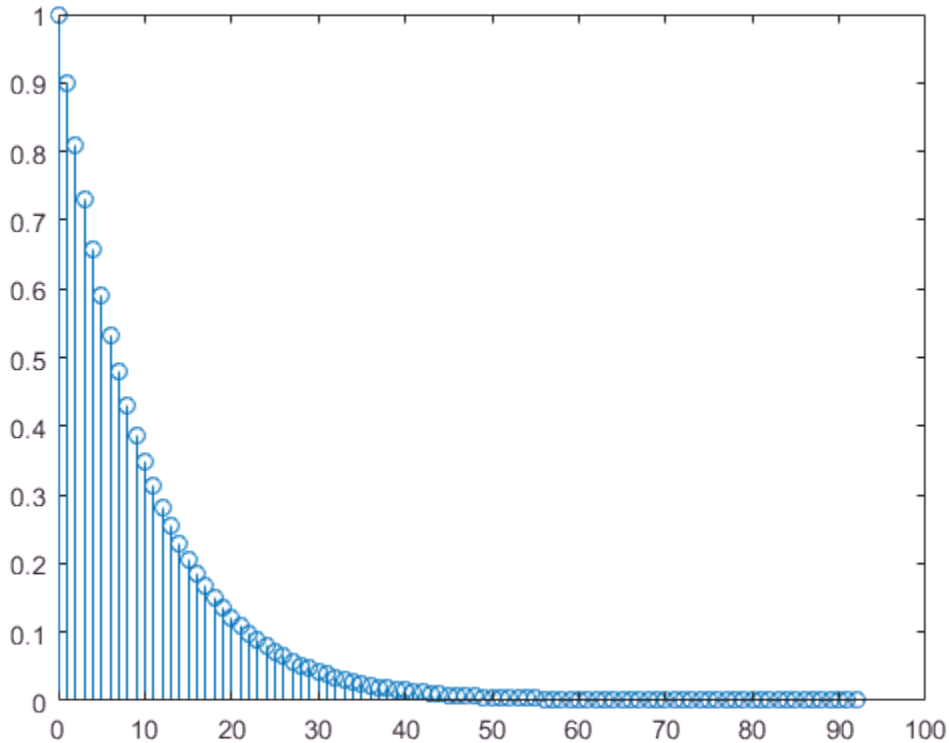

`h(len)`

`ans = 6.1704e-05`

IIR Filter Effective Impulse Response Length — Second-Order Sections

Design a 4th-order lowpass elliptic filter with a cutoff frequency of 0.4π rad/sample. Specify 1 dB of passband ripple and 60 dB of stopband attenuation. Design the filter in pole-zero-gain form and obtain the second-order section matrix using `zp2sos`. Determine the effective impulse response sequence length from the second-order section matrix.

```
[z,p,k] = ellip(4,1,60,.4);
```

```
[sos,g] = zp2sos(z,p,k);  
len = impzlength(sos)
```

```
len = 80
```

IIR Filter Effective Impulse Response Length — Digital Filter

Use `designfilt` to design a 4th-order lowpass elliptic filter with normalized passband frequency 0.4π rad/sample. Specify 1 dB of passband ripple and 60 dB of stopband attenuation. Determine the effective impulse response sequence length and visualize it.

```
d = designfilt('lowpassiir','FilterOrder',4,'PassbandFrequency',0.4, ...  
              'PassbandRipple',1,'StopbandAttenuation',60, ...  
              'DesignMethod','ellip');
```

```
len = impzlength(d)
```

```
len = 80
```

```
impz(d)
```

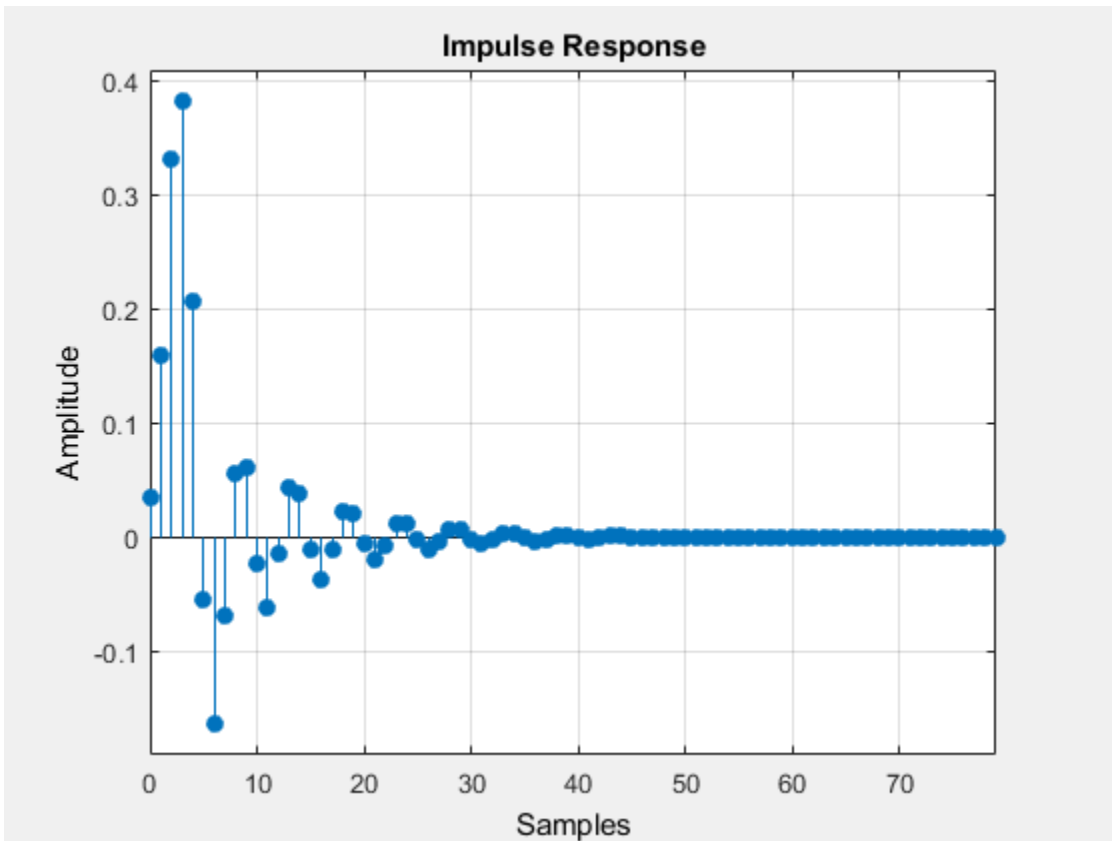

Input Arguments

b — Numerator coefficients

vector | scalar

Numerator coefficients, specified as a scalar (allpole filter) or a vector.

Example: `b = fir1(20,0.25)`

Data Types: `single` | `double`

Complex Number Support: Yes

a — Denominator coefficients

vector | scalar

Denominator coefficients, specified as a scalar (FIR filter) or vector.

Data Types: `single` | `double`

Complex Number Support: Yes

sos — Matrix of second order sections

matrix

Matrix of second order sections, specified as a K -by-6 matrix. The system function of the K -th biquad filter has the rational Z-transform

$$H_k(z) = \frac{B_k(1) + B_k(2)z^{-1} + B_k(3)z^{-2}}{A_k(1) + A_k(2)z^{-1} + A_k(3)z^{-2}}.$$

The coefficients in the K th row of the matrix, `sos`, are ordered as follows.

$$[B_k(1) \quad B_k(2) \quad B_k(3) \quad A_k(1) \quad A_k(2) \quad A_k(3)]$$

The frequency response of the filter is the system function evaluated on the unit circle with

$$z = e^{j2\pi f}.$$

d — Digital filter

digitalFilter object

Digital filter, specified as a digitalFilter object. Use `designfilt` to generate a digital filter based on frequency-response specifications.Example: `d =`

```
designfilt('lowpassiir','FilterOrder',3,'HalfPowerFrequency',0.5)
```

 specifies a third-order Butterworth filter with normalized 3-dB frequency 0.5π rad/sample.
hd — Filter object

dfilt object

Filter object, specified as a `dfilt` object.

tol — Tolerance for IIR filter effective impulse response length

5e-5 (default) | positive scalar

Tolerance for IIR filter effective impulse response length, specified as a positive number. The tolerance determines the term in the absolutely summable sequence after which subsequent terms are considered to be 0. The default tolerance is 5e-5. Increasing the tolerance returns a shorter effective impulse response sequence length. Decreasing the tolerance returns a longer effective impulse response sequence length.

Output Arguments

len — Length of impulse response

positive integer

Length of the impulse response, specified as a positive integer. For stable IIR filters with absolutely summable impulse responses, `impzlength` returns an effective length for the impulse response beyond which the coefficients are essentially zero. You can control this cutoff point by specifying the optional `tol` input argument.

See Also

See Also

`digitalFilter` | `designfilt` | `impz` | `zp2sos`

Introduced in R2013a

info

Information about digital filter

Syntax

```
s = info(d)
```

Description

`s = info(d)` returns a character array with information about the digital filter, `d`.

Examples

Information on a Lowpass FIR Filter

Design a lowpass FIR filter with normalized passband frequency 0.4π rad/sample and normalized stopband frequency 0.45π rad/sample. Obtain information about the filter just designed.

```
d = designfilt('lowpassfir','PassbandFrequency',0.4,'StopbandFrequency',0.45);  
s = info(d)
```

```
s = 17x44 char array  
'FIR Digital Filter (real)'  
'-----'  
'Filter Length : 81'  
'Stable : Yes'  
'Linear Phase : Yes (Type 1)'  
'  
'Design Method Information'  
'Design Algorithm : Equiripple'  
'  
'Design Specifications'  
'Sample Rate : N/A (normalized frequency)'  
'Response : Lowpass'  
'Specification : Fp,Fst,Ap,Ast'
```

```
'Stopband Atten. : 60 dB           '  
'Passband Ripple : 1 dB           '  
'Stopband Edge   : 0.45          '  
'Passband Edge   : 0.4           '
```

Input Arguments

d — Digital filter

digitalFilter object

Digital filter, specified as a digitalFilter object. Use `designfilt` to generate a digital filter based on frequency-response specifications.

Example: `d = designfilt('lowpassiir','FilterOrder',3,'HalfPowerFrequency',0.5)` specifies a third-order Butterworth filter with normalized 3-dB frequency 0.5π rad/sample.

Output Arguments

s — Information table

character array

Information table, returned as a character array.

See Also

See Also

`designfilt` | `digitalFilter`

Introduced in R2014a

interp

Interpolation — increase sampling rate by integer factor

Syntax

```
y = interp(x,r)
y = interp(x,r,n,alpha)
[y,b] = interp(x,r,n,alpha)
```

Description

Interpolation increases the original sampling rate of a sequence to a higher rate. It is the opposite of decimation. `interp` inserts 0s into the original signal and then applies a lowpass interpolating filter to the expanded sequence.

`y = interp(x,r)` increases the sampling rate of `x`, the input signal, by a factor of `r`. The interpolated vector, `y`, is `r` times as long as the original input, `x`.

`y = interp(x,r,n,alpha)` specifies two additional values. `n` is half the number of original sample values used to interpolate the expanded signal. Its default value is 4. It should ideally be less than or equal to 10. `alpha` is the normalized cutoff frequency of the input signal, specified as a fraction of the Nyquist frequency. It defaults to 0.5. The lowpass interpolation filter has length $2*n*r + 1$.

`[y,b] = interp(x,r,n,alpha)` also returns a vector, `b`, with the filter coefficients used for the interpolation.

Input Arguments

x — Input signal

vector

Input signal, specified as a vector.

Data Types: `double`

r — Interpolation factor

positive integer scalar

Interpolation factor, specified as a positive integer scalar.

Data Types: `double`

n — Half-number of input samples used for interpolation

4 (default) | positive integer scalar

Half-number of input samples used for interpolation, specified as a positive integer scalar. `n` should never be greater than 10.

Data Types: `double`

alpha — Normalized cutoff frequency

0.5 (default) | positive scalar

Normalized cutoff frequency of the input signal, specified as a positive real scalar not greater than 1. A value of 1 means that the signal occupies the full Nyquist interval.

Data Types: `double`

Output Arguments

y — Interpolated signal

vector

Interpolated signal, returned as a vector.

Data Types: `double`

b — Lowpass interpolation filter coefficients

column vector

Lowpass interpolation filter coefficients, returned as a column vector.

Data Types: `double`

Examples

Interpolate a Signal

Create a sinusoidal signal sampled at 1 kHz. Interpolate it by a factor of four.

```
t = 0:0.001:1;  
x = sin(2*pi*30*t) + sin(2*pi*60*t);  
y = interp(x,4);
```

Plot the original and interpolated signals.

```
subplot 211  
stem(0:30,x(1:31),'filled','markersize',3)  
grid on  
xlabel 'Sample number',ylabel Original  
subplot 212  
stem(0:120,y(1:121),'filled','markersize',3)  
grid on  
xlabel 'Sample number',ylabel Interpolated
```

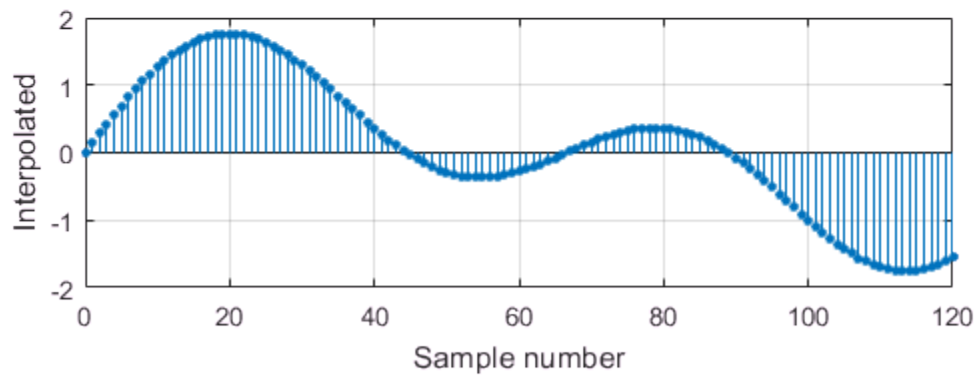
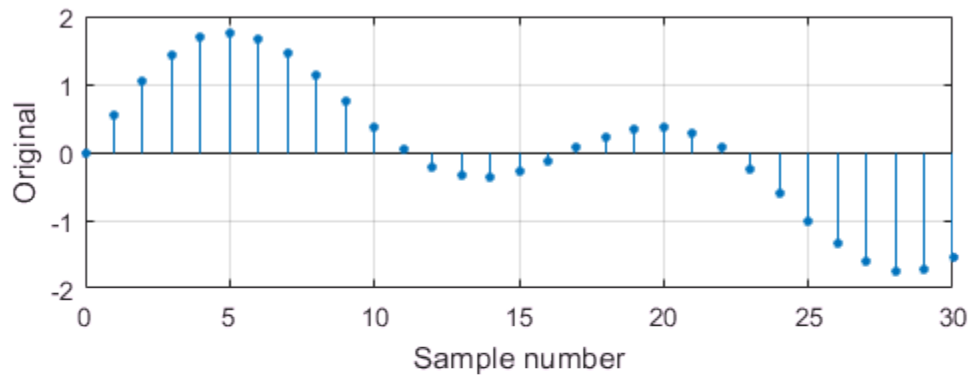

Algorithms

`interp` uses the lowpass interpolation algorithm 8.1 described in [1].

- 1 It expands the input vector to the correct length by inserting 0s between the original data values.
- 2 It designs a special symmetric FIR filter that allows the original data to pass through unchanged and interpolates to minimize the mean-square error between the interpolated points and their ideal values. The filter used by `interp` is the same as the filter returned by `intfilt`.
- 3 It applies the filter to the expanded input vector to produce the output.

References

- [1] Digital Signal Processing Committee of the IEEE Acoustics, Speech, and Signal Processing Society, eds. *Programs for Digital Signal Processing*. New York: IEEE Press, 1979, chap.8.
- [2] Oetken, G., Thomas W. Parks, and H. W. Schüssler. “New results in the design of digital interpolators.” *IEEE Transactions on Acoustics, Speech, and Signal Processing*. Vol. ASSP-23, 1975, pp.301–309.

See Also

`decimate` | `downsample` | `interp1` | `intfilt` | `resample` | `spline` | `upfirdn` | `upsample`

Introduced before R2006a

intfilt

Interpolation FIR filter design

Syntax

```
b = intfilt(l,p,alpha)
b = intfilt(l,n,'Lagrange')
```

Description

`b = intfilt(l,p,alpha)` designs a linear phase FIR filter that performs ideal bandlimited interpolation using the nearest $2 \cdot p$ nonzero samples, when used on a sequence interleaved with $l - 1$ consecutive zeros every l samples. It assumes an original bandlimitedness of α times the Nyquist frequency. The returned filter is identical to that used by `interp`. `b` is length $2 \cdot l \cdot p - 1$.

α is inversely proportional to the transition bandwidth of the filter and it also affects the bandwidth of the don't-care regions in the stopband. Specifying α allows you to specify how much of the Nyquist interval your input signal occupies. This is beneficial, particularly for signals to be interpolated, because it allows you to increase the transition bandwidth without affecting the interpolation and results in better stopband attenuation for a given l and p . If you set α to 1, your signal is assumed to occupy the entire Nyquist interval. Setting α to less than one allows for don't-care regions in the stopband. For example, if your input occupies half the Nyquist interval, you could set α to 0.5.

`b = intfilt(l,n,'Lagrange')` designs an FIR filter that performs n th-order Lagrange polynomial interpolation on a sequence interleaved with $l - 1$ consecutive zeros every r samples. `b` has length $(n+1) \cdot l$ for n even, and length $(n+1) \cdot l - 1$ for n odd. If both n and l are even, the filter designed is not linear phase.

Both types of filters are basically lowpass and have a gain of l in the passband.

Examples

Digital Interpolation Filter

Design a digital interpolation filter to upsample a signal by seven, using the bandlimited method. Specify a "bandlimitedness" factor of 0.5 and use 2×2 samples in the interpolation.

```
upfac = 7;
alpha = 0.5;
h1 = intfilt(upfac,2,alpha);
```

The filter works best when the original signal is bandlimited to `alpha` times the Nyquist frequency. Create a bandlimited noise signal by generating 200 Gaussian random numbers and filtering the sequence with a 40th-order FIR lowpass filter. Reset the random number generator for reproducible results.

```
lowp = fir1(40,alpha);

rng('default')
x = filter(lowp,1,randn(200,1));
```

Increase the sample rate of the signal by inserting zeros between each pair of samples of `x`.

```
xr = upsample(x,upfac);
```

Use the `filter` function to produce an interpolated signal.

```
y = filter(h1,1,xr);
```

Compensate for the delay introduced by the filter. Plot the original and interpolated signals.

```
delay = mean(grpdelay(h1));

y(1:delay) = [];

stem(1:upfac:upfac*length(x),x)
hold on
plot(y)
```



```
xlim([400 700])
```

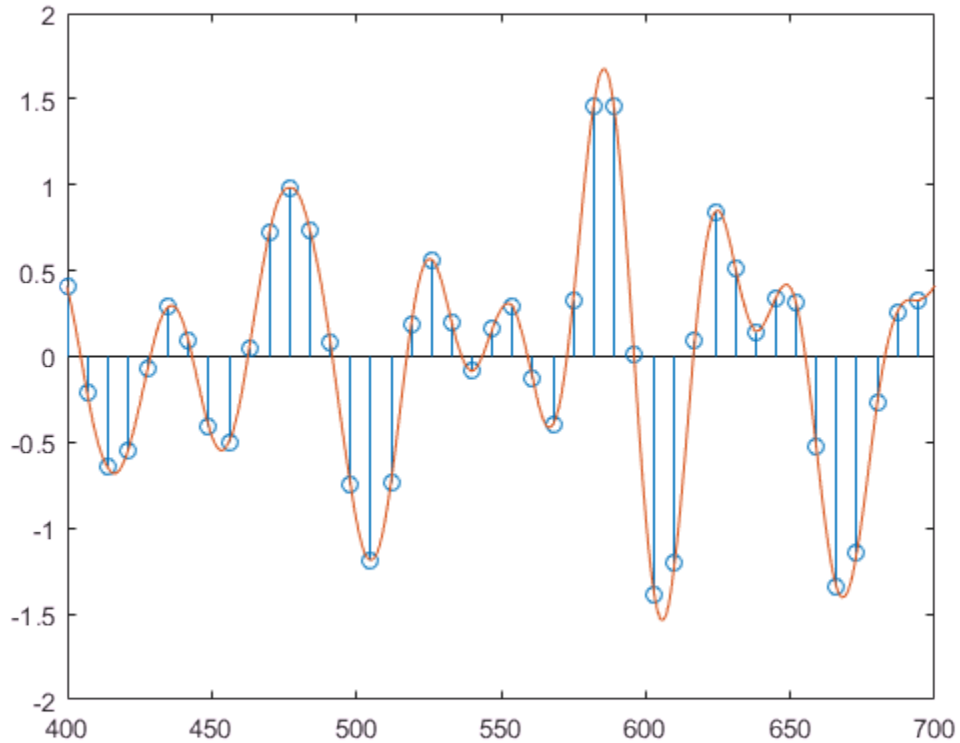

`intfilt` also performs Lagrange polynomial interpolation.

- First-order polynomial interpolation is just linear interpolation, which is accomplished with a triangular filter.
- Zeroth-order interpolation is accomplished with a moving average filter and resembles the output of a sample-and-hold display.

Interpolate the original signal and overlay the result.

```
h2 = intfilt(upfac,1, 'Lagrange');
```

```
y2 = filter(h2,1,xr);  
y2(1:floor(mean(grpdelay(h2)))) = [];  
  
plot(y2)  
hold off
```

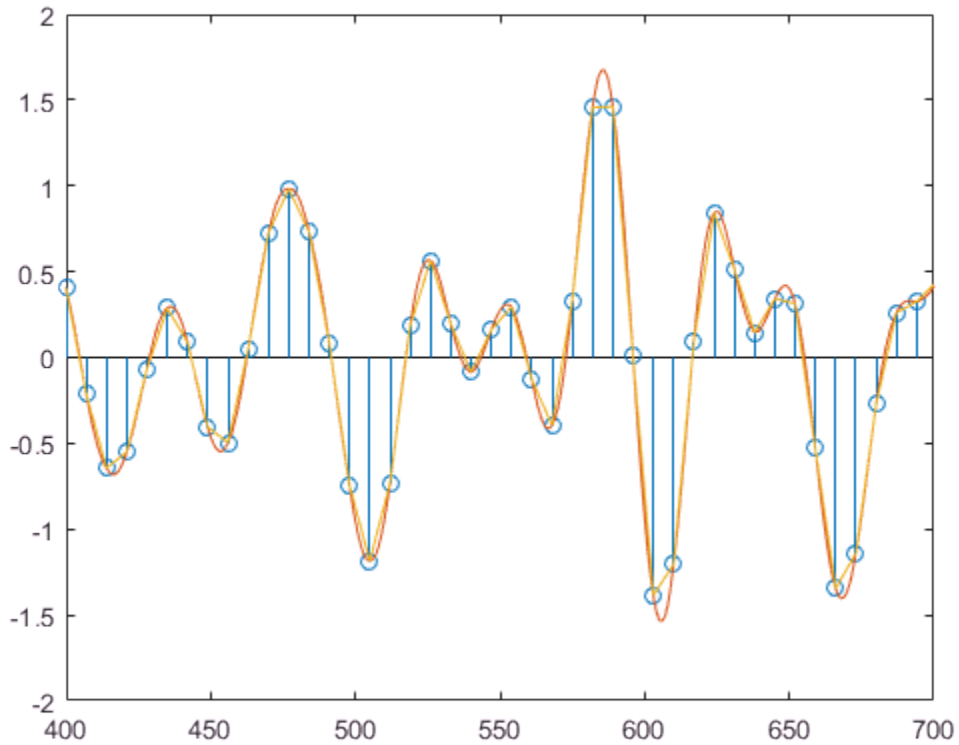

Algorithms

The bandlimited method uses `firls` to design an interpolation FIR filter. The polynomial method uses Lagrange's polynomial interpolation formula on equally spaced samples to construct the appropriate filter.

Extended Capabilities

C/C++ Code Generation

Generate C and C++ code using MATLAB® Coder™.

Usage notes and limitations:

All inputs must be constant. Expressions or variables are allowed if their values do not change.

See Also

`decimate` | `interp` | `downsample` | `resample` | `upsample`

Introduced before R2006a

invfreqs

Identify continuous-time filter parameters from frequency response data

Syntax

```
[b,a] = invfreqs(h,w,n,m)
[b,a] = invfreqs(h,w,n,m,wt)
[b,a] = invfreqs(h,w,n,m,wt,iter)
[b,a] = invfreqs(h,w,n,m,wt,iter,tol)
[b,a] = invfreqs(h,w,n,m,wt,iter,tol,'trace')
[b,a] = invfreqs(h,w,'complex',n,m,...)
```

Description

`invfreqs` is the inverse operation of `freqs`. It finds a continuous-time transfer function that corresponds to a given complex frequency response. From a laboratory analysis standpoint, `invfreqs` is useful in converting magnitude and phase data into transfer functions.

`[b,a] = invfreqs(h,w,n,m)` returns the real numerator and denominator coefficient vectors `b` and `a` of the transfer function

$$H(s) = \frac{B(s)}{A(s)} = \frac{b(1)s^n + b(2)s^{n-1} + \dots + b(n+1)}{a(1)s^m + a(2)s^{m-1} + \dots + a(m+1)}$$

whose complex frequency response is given in vector `h` at the frequency points specified in vector `w`. Scalars `n` and `m` specify the desired orders of the numerator and denominator polynomials.

The length of `h` must be the same as the length of `w`. `invfreqs` uses `conj(h)` at `-w` to ensure the proper frequency domain symmetry for a real filter.

`[b,a] = invfreqs(h,w,n,m,wt)` weights the fit-errors versus frequency, where `wt` is a vector of weighting factors the same length as `w`.

`[b,a] = invfreqs(h,w,n,m,wt,iter)` and

`[b,a] = invfreqs(h,w,n,m,wt,iter,tol)` provide a superior algorithm that guarantees stability of the resulting linear system and searches for the best fit using a numerical, iterative scheme. The `iter` parameter tells `invfreqs` to end the iteration when the solution has converged, or after `iter` iterations, whichever comes first. `invfreqs` defines convergence as occurring when the norm of the (modified) gradient vector is less than `tol`, where `tol` is an optional parameter that defaults to 0.01. To obtain a weight vector of all ones, use

```
invfreqs(h,w,n,m,[],iter,tol)
```

`[b,a] = invfreqs(h,w,n,m,wt,iter,tol,'trace')` displays a textual progress report of the iteration.

`[b,a] = invfreqs(h,w,'complex',n,m,...)` creates a complex filter. In this case no symmetry is enforced, and the frequency is specified in radians between $-\pi$ and π .

Examples

Transfer Function to Frequency Response Conversion

Convert a simple transfer function to frequency-response data and then back to the original filter coefficients.

```
a = [1 2 3 2 1 4];
b = [1 2 3 2 3];
```

```
[h,w] = freqs(b,a,64);
[bb,aa] = invfreqs(h,w,4,5)
```

```
bb =
```

```
    1.0000    2.0000    3.0000    2.0000    3.0000
```

```
aa =
```

```
    1.0000    2.0000    3.0000    2.0000    1.0000    4.0000
```

`bb` and `aa` are equivalent to `b` and `a`, respectively. However, the system is unstable because `aa` has poles with positive real part. View the poles of `bb` and `aa`.

zplane(bb,aa)

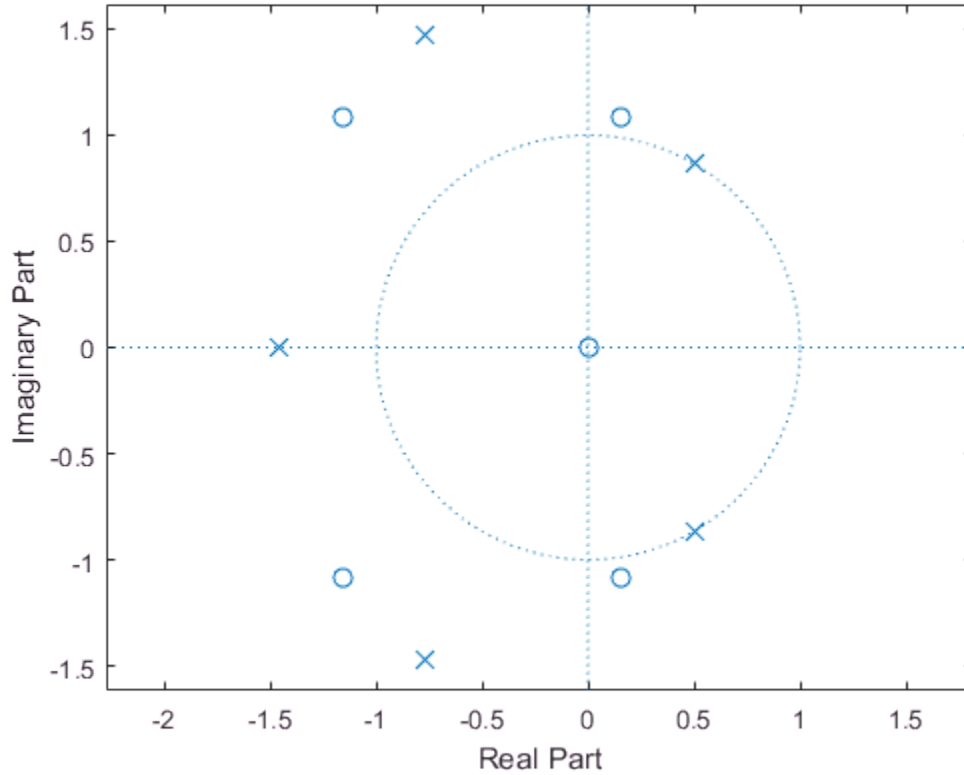

Use the iterative algorithm of `invfreqs` to find a stable approximation to the system.

```
[bbb,aaa] = invfreqs(h,w,4,5,[],30)
```

bbb =

```
0.6816    2.1015    2.6694    0.9113   -0.1218
```

aaa =

```
1.0000    3.4676    7.4060    6.2102    2.5413    0.0001
```

Verify that the system is stable by plotting the new poles.

```
zplane(bbb,aaa)
```

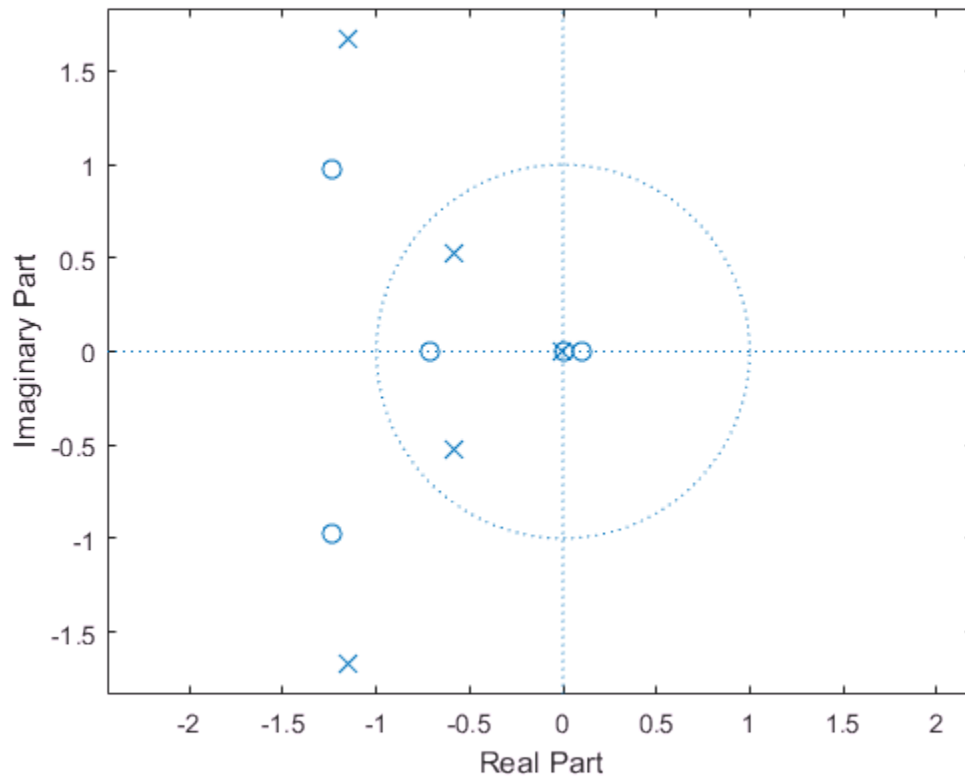

Continuous-Time Transfer Function

Generate two vectors, `mag` and `phase`, that simulate magnitude and phase data gathered in a laboratory. Also generate a vector, `w`, of frequencies.

```
rng('default')
```

```

fs = 1000;
t = 0:1/fs:2;
mag = periodogram(sin(2*pi*100*t)+randn(size(t))/10,[],[],fs);
phase = randn(size(mag))/10;
w = linspace(0,fs/2,length(mag))';

```

Use `invfreqs` to convert the data into a continuous-time transfer function. Plot the result.

```

[b,a] = invfreqs(mag.*exp(1j*phase),w,2,2,[],4);
freqs(b,a)

```

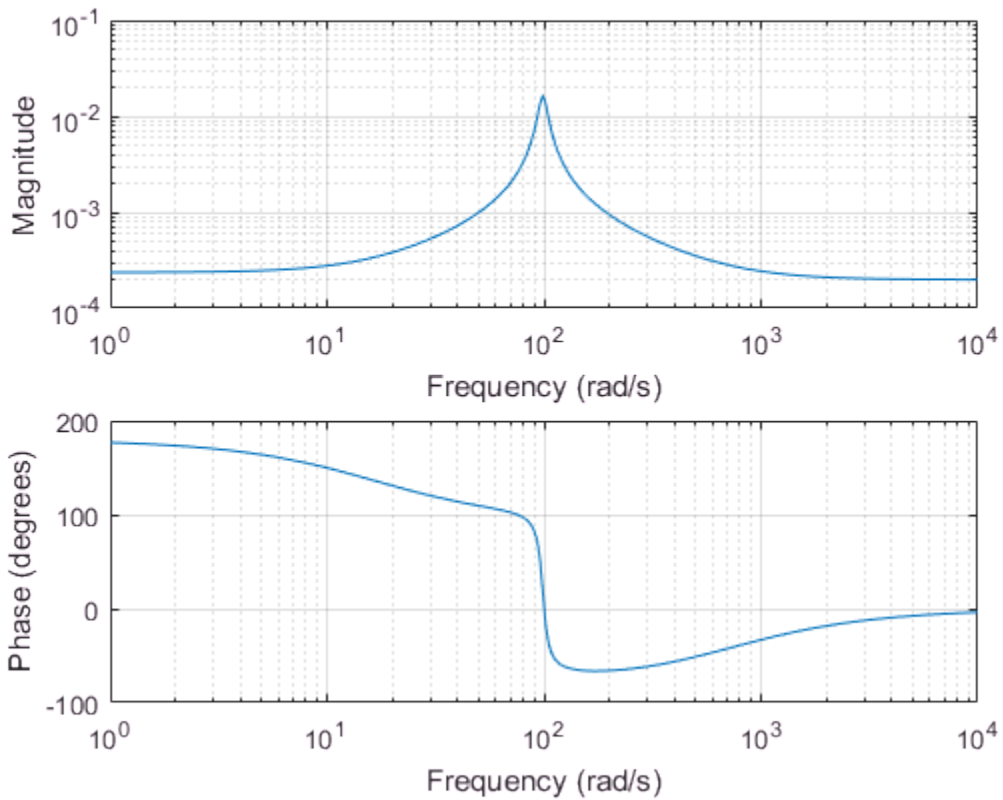

Tips

When building higher order models using high frequencies, it is important to scale the frequencies, dividing by a factor such as half the highest frequency present in w , so as to obtain well conditioned values of \mathbf{a} and \mathbf{b} . This corresponds to a rescaling of time.

Algorithms

By default, `invfreqs` uses an equation error method to identify the best model from the data. This finds \mathbf{b} and \mathbf{a} in

$$\min_{b,a} \sum_{k=1}^n wt(k) |h(k)A(w(k)) - B(w(k))|^2$$

by creating a system of linear equations and solving them with the MATLAB `\` operator. Here $A(w(k))$ and $B(w(k))$ are the Fourier transforms of the polynomials \mathbf{a} and \mathbf{b} , respectively, at the frequency $w(k)$, and n is the number of frequency points (the length of \mathbf{h} and \mathbf{w}). This algorithm is based on Levi [1]. Several variants have been suggested in the literature, where the weighting function wt gives less attention to high frequencies.

The superior (“output-error”) algorithm uses the damped Gauss-Newton method for iterative search [2], with the output of the first algorithm as the initial estimate. This solves the direct problem of minimizing the weighted sum of the squared error between the actual and the desired frequency response points.

$$\min_{b,a} \sum_{k=1}^n wt(k) \left| h(k) - \frac{B(w(k))}{A(w(k))} \right|^2$$

References

- [1] Levi, E. C. “Complex-Curve Fitting.” *IRE Trans. on Automatic Control*. Vol. AC-4, 1959, pp.37–44.
- [2] Dennis, J. E., Jr., and R. B. Schnabel. *Numerical Methods for Unconstrained Optimization and Nonlinear Equations*. Englewood Cliffs, NJ: Prentice-Hall, 1983.

See Also

freqs | freqz | invfreqz | prony

Introduced before R2006a

invfreqz

Identify discrete-time filter parameters from frequency response data

Syntax

```
[b,a] = invfreqz(h,w,n,m)
[b,a] = invfreqz(h,w,n,m,wt)
[b,a] = invfreqz(h,w,n,m,wt,iter)
[b,a] = invfreqz(h,w,n,m,wt,iter,tol)
[b,a] = invfreqz(h,w,n,m,wt,iter,tol,'trace')
[b,a] = invfreqz(h,w,'complex',n,m,...)
```

Description

`invfreqz` is the inverse operation of `freqz`; it finds a discrete-time transfer function that corresponds to a given complex frequency response. From a laboratory analysis standpoint, `invfreqz` can be used to convert magnitude and phase data into transfer functions.

`[b,a] = invfreqz(h,w,n,m)` returns the real numerator and denominator coefficients in vectors `b` and `a` of the transfer function

$$H(z) = \frac{B(z)}{A(z)} = \frac{b(1) + b(2)z^{-1} + \dots + b(n+1)z^{-n}}{a(1) + a(2)z^{-1} + \dots + a(m+1)z^{-m}}$$

whose complex frequency response is given in vector `h` at the frequency points specified in vector `w`. Scalars `n` and `m` specify the desired orders of the numerator and denominator polynomials.

Frequency is specified in radians between 0 and π , and the length of `h` must be the same as the length of `w`. `invfreqz` uses `conj(h)` at `-w` to ensure the proper frequency domain symmetry for a real filter.

`[b,a] = invfreqz(h,w,n,m,wt)` weights the fit-errors versus frequency, where `wt` is a vector of weighting factors the same length as `w`.

`[b,a] = invfreqz(h,w,n,m,wt,iter)` and

`[b,a] = invfreqz(h,w,n,m,wt,iter,tol)` provide a superior algorithm that guarantees stability of the resulting linear system and searches for the best fit using a numerical, iterative scheme. The `iter` parameter tells `invfreqz` to end the iteration when the solution has converged, or after `iter` iterations, whichever comes first. `invfreqz` defines convergence as occurring when the norm of the (modified) gradient vector is less than `tol`, where `tol` is an optional parameter that defaults to 0.01. To obtain a weight vector of all ones, use

`invfreqz(h,w,n,m,[],iter,tol)`

`[b,a] = invfreqz(h,w,n,m,wt,iter,tol,'trace')` displays a textual progress report of the iteration.

`[b,a] = invfreqz(h,w,'complex',n,m,...)` creates a complex filter. In this case no symmetry is enforced, and the frequency is specified in radians between $-\pi$ and π .

Examples

Stable Approximate Transfer Function

Convert a simple transfer function to frequency response data and then back to the original filter coefficients. Sketch the zeros and poles of the function.

```
a = [1 2 3 2 1 4];
b = [1 2 3 2 3];
```

```
[h,w] = freqz(b,a,64);
[bb,aa] = invfreqz(h,w,4,5)
```

bb =

```
1.0000    2.0000    3.0000    2.0000    3.0000
```

aa =

```
1.0000    2.0000    3.0000    2.0000    1.0000    4.0000
```

```
zplane(bb,aa)
```

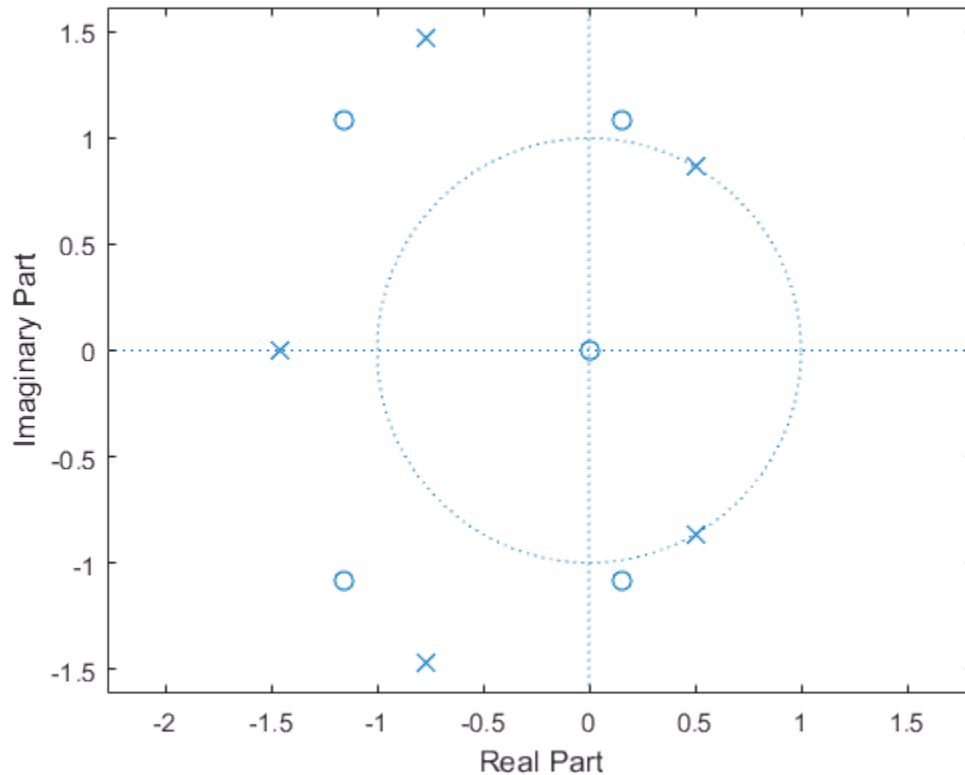

`bb` and `aa` are equivalent to `b` and `a`, respectively. However, the system is unstable because it has poles outside the unit circle. Use `invfreqz`'s iterative algorithm to find a stable approximation to the system. Verify that the poles are within the unit circle.

```
[bbb,aaa] = invfreqz(h,w,4,5,[],30)
```

```
bbb =
```

```
    0.2427    0.2788    0.0069    0.0971    0.1980
```

```
aaa =
```

1.0000 -0.8944 0.6954 0.9997 -0.8933 0.6949

zplane(bbb,aaa)

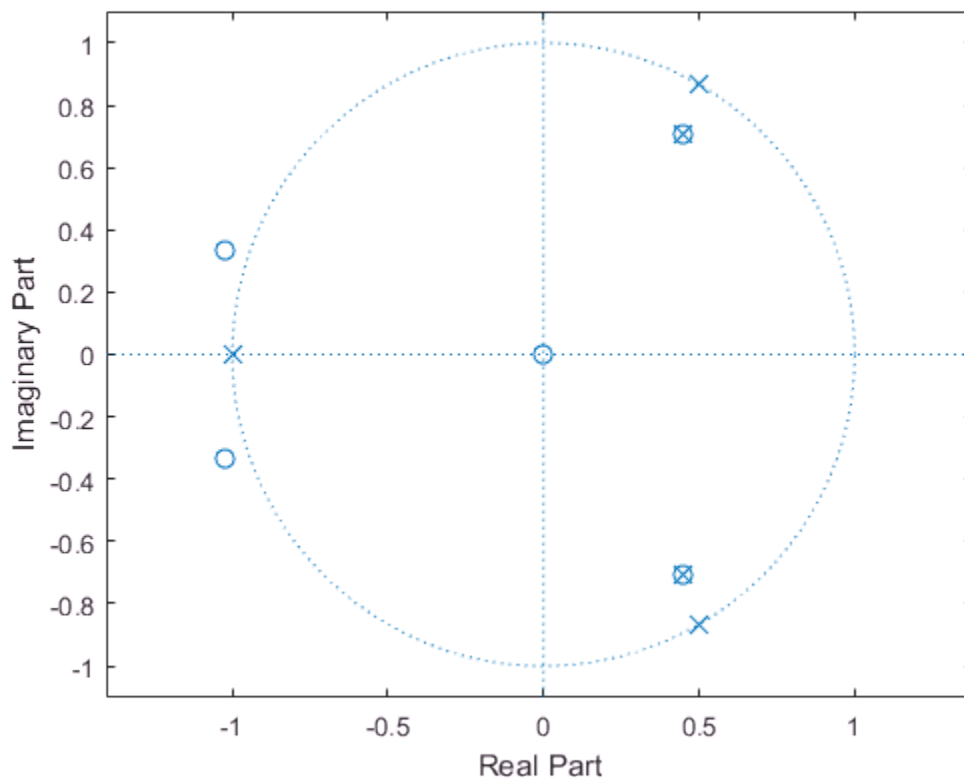

Algorithms

By default, `invfreqz` uses an equation error method to identify the best model from the data. This finds `b` and `a` in

$$\min_{b,a} \sum_{k=1}^n w t(k) |h(k)A(w(k)) - B(w(k))|^2$$

by creating a system of linear equations and solving them with the MATLAB \ operator. Here $A(\omega(k))$ and $B(\omega(k))$ are the Fourier transforms of the polynomials \mathbf{a} and \mathbf{b} , respectively, at the frequency $\omega(k)$, and n is the number of frequency points (the length of \mathbf{h} and \mathbf{w}). This algorithm is based on Levi [1].

The superior (“output-error”) algorithm uses the damped Gauss-Newton method for iterative search [2], with the output of the first algorithm as the initial estimate. This solves the direct problem of minimizing the weighted sum of the squared error between the actual and the desired frequency response points.

$$\min_{b,a} \sum_{k=1}^n w t(k) \left| h(k) - \frac{B(w(k))}{A(w(k))} \right|^2$$

References

- [1] Levi, E. C. “Complex-Curve Fitting.” *IRE Transactions on Automatic Control*. Vol.AC-4, 1959, pp.37–44.
- [2] Dennis, J. E., Jr., and R. B. Schnabel. *Numerical Methods for Unconstrained Optimization and Nonlinear Equations*. Englewood Cliffs, NJ: Prentice-Hall, 1983.

See Also

freqs | freqz | prony

Introduced before R2006a

isallpass

Determine whether filter is allpass

Syntax

```
flag = isallpass(b,a)
flag = isallpass(sos)
flag = isallpass(d)
flag = isallpass(...,tol)
flag = isallpass(hd)
```

Description

`flag = isallpass(b,a)` returns a logical output, `flag`, equal to `true` if the filter specified by numerator coefficients, `b`, and denominator coefficients, `a`, is an allpass filter. If the filter is not an allpass filter, `flag` is equal to `false`.

`flag = isallpass(sos)` returns `true` if the filter specified by second order sections matrix, `sos`, is an allpass filter. `sos` is a K -by-6 matrix, where the number of sections, K , must be greater than or equal to 2. Each row of `sos` corresponds to the coefficients of a second order (biquad) filter. The i th row of the `sos` matrix corresponds to `[bi(1) bi(2) bi(3) ai(1) ai(2) ai(3)]`.

`flag = isallpass(d)` returns `true` if the digital filter, `d`, is an allpass filter. Use `designfilt` to generate `d` based on frequency-response specifications.

`flag = isallpass(...,tol)` uses the tolerance, `tol`, to determine when two numbers are close enough to be considered equal. If not specified, `tol`, defaults to $\text{eps}^{2/3}$. Specifying a tolerance may be most helpful in fixed-point allpass filters.

`flag = isallpass(hd)` returns `true` if the filter object `hd` is an allpass filter.

Examples

Allpass Filters

Create an allpass filter and verify that the frequency response is allpass.



```

b = [1/3 1/4 1/5 1];
a = fliplr(b);
flag = isallpass(b,a)

flag = logical
     1

```

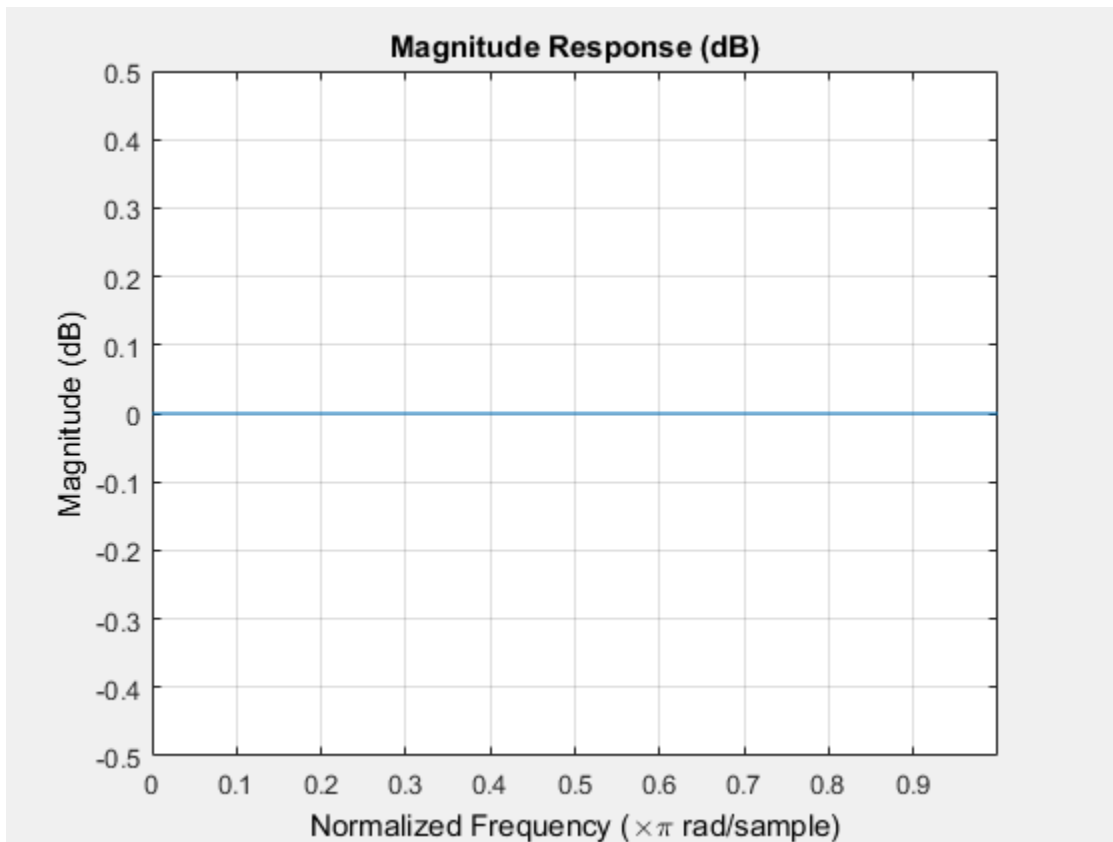
```
fvtool(b,a)
```



Create a lattice allpass filter and verify that the filter is allpass.

```

k = [1/2 1/3 1/4 1/5];
[b,a] = latc2tf(k,'allpass');
flag_isallpass = isallpass(b,a)

```

```
flag_isallpass = logical  
1
```

```
fvtool(b,a)
```

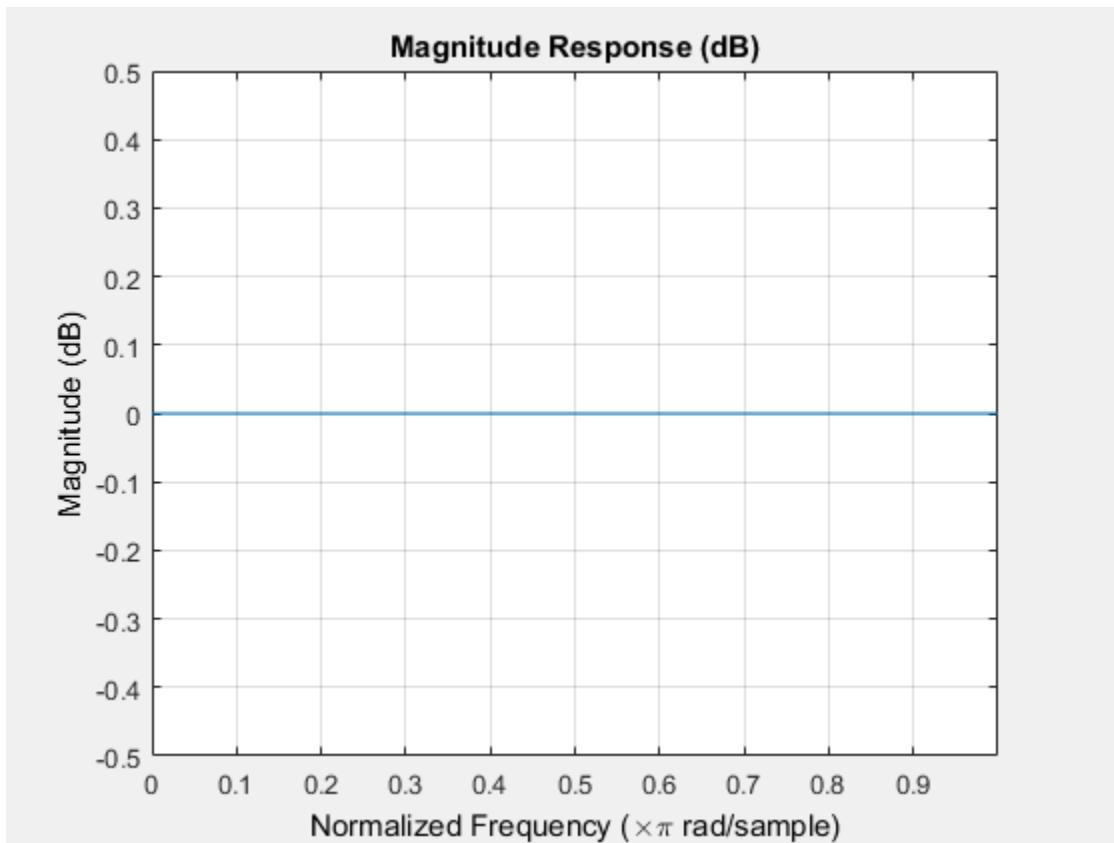

See Also

`designfilt` | `digitalFilter` | `islinphase` | `ismaxphase` | `isminphase` | `isstable`

Introduced in R2013a

isdouble

Determine if digital filter coefficients are double precision

Syntax

```
flag = isdouble(d)
```

Description

`flag = isdouble(d)` returns `true` if the coefficients of a digital filter, `d`, are double precision.

Examples

Double- and Single-Precision Filter

Use `designfilt` to design a sixth-order highpass IIR filter. Specify a normalized passband frequency of 0.6π rad/sample. Convert it to a single-precision filter. Identify the precision in each case.

```
fd = designfilt('highpassiir', 'FilterOrder',6, 'PassbandFrequency',0.6);  
isd = isdouble(fd)
```

```
isd = logical  
     1
```

```
fs = single(fd);  
iss = isdouble(fs)
```

```
iss = logical  
     0
```

Input Arguments

d — Digital filter

`digitalFilter` object

Digital filter, specified as a `digitalFilter` object. Use `designfilt` to generate `d`. If you want a single-precision filter, apply `single` to the output of `designfilt`.

Example: `d = designfilt('lowpassiir','FilterOrder',3,'HalfPowerFrequency',0.5)` specifies a third-order Butterworth filter with normalized 3-dB frequency 0.5π rad/sample.

Output Arguments

flag — Type identification

logical scalar

Type identification, returned as a logical scalar.

See Also

See Also

`designfilt` | `digitalFilter` | `double` | `issingle` | `single`

Introduced in R2014a

isfir

Determine if digital filter has finite impulse response

Syntax

```
flag = isfir(d)
```

Description

`flag = isfir(d)` returns `true` if a digital filter, `d`, has a finite impulse response.

Examples

FIR and IIR Digital Filters

Use `designfilt` to design FIR and IIR versions of a highpass filter. Specify a normalized stopband frequency of 0.3 and a normalized passband frequency of 0.6. Verify that each filter is of the correct class. Display the frequency responses of the filters.

```
fir = designfilt('highpassfir','StopbandFrequency',0.3,'PassbandFrequency',0.6);  
iir = designfilt('highpassiir','StopbandFrequency',0.3,'PassbandFrequency',0.6);  
isfirFIR = isfir(fir)
```

```
isfirFIR = logical  
         1
```

```
isiirFIR = isfir(iir)
```

```
isiirFIR = logical  
         0
```

```
fvt = fvtool(fir,iir);  
legend(fvt,'FIR','IIR')
```

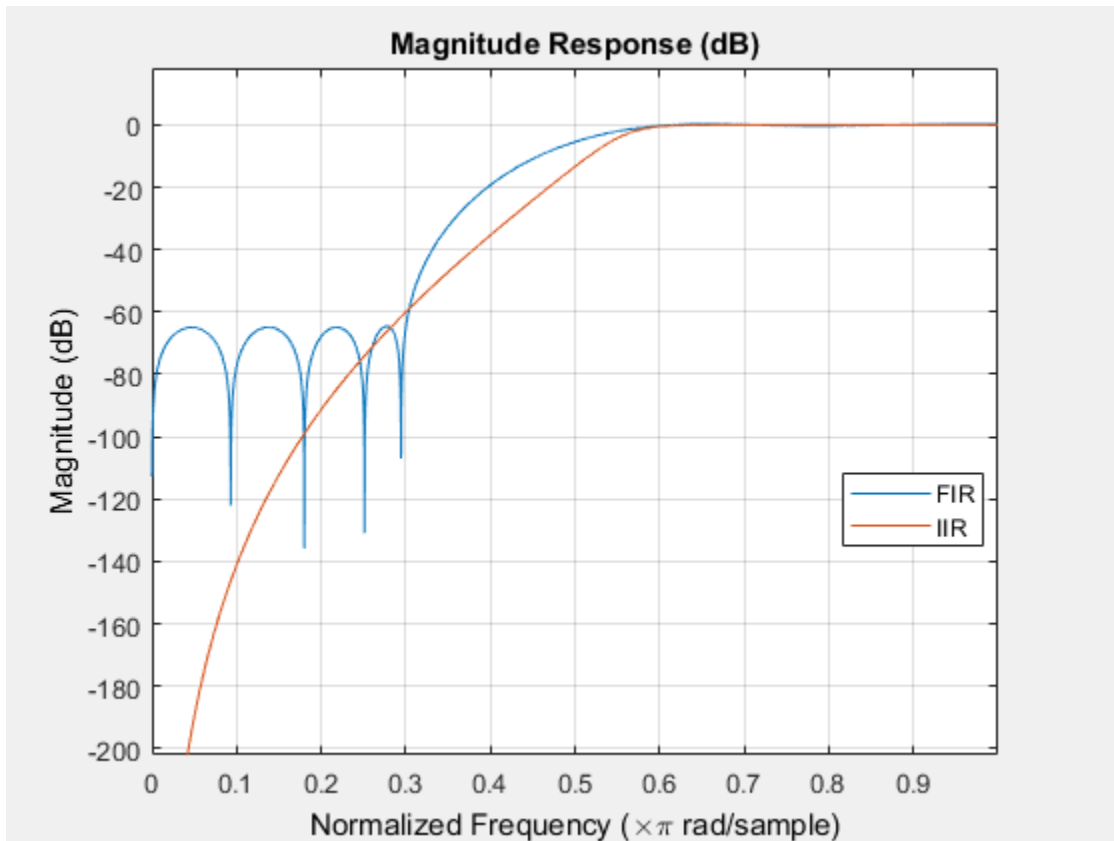

Input Arguments

d — Digital filter

digitalFilter object

Digital filter, specified as a digitalFilter object. Use `designfilt` to generate a digital filter based on frequency-response specifications.

Example: `d =`

```
designfilt('lowpassiir','FilterOrder',3,'HalfPowerFrequency',0.5)
```

specifies a third-order Butterworth filter with normalized 3-dB frequency 0.5π rad/sample.

Output Arguments

flag — Filter class identification

logical scalar

Filter class identification, returned as a logical scalar.

See Also

See Also

`designfilt` | `digitalFilter` | `firtype` | `isdouble` | `issingle`

Introduced in R2014a

islinphase

Determine whether filter has linear phase

Syntax

```
flag = islinphase(b,a)
flag = islinphase(sos)
flag = islinphase(d)
flag = islinphase(...,tol)
flag = islinphase(h)
```

Description

`flag = islinphase(b,a)` returns a logical output, `flag`, equal to `true` if the filter coefficients in `b` and `a` define a linear phase filter. `flag` is equal to `false` if the filter does not have linear phase.

`flag = islinphase(sos)` returns `true` if the filter specified by second order sections matrix, `sos`, has linear phase. `sos` is a K -by-6 matrix, where the number of sections, K , must be greater than or equal to 2. Each row of `sos` corresponds to the coefficients of a second order (biquad) filter. The i th row of the `sos` matrix corresponds to `[bi(1) bi(2) bi(3) ai(1) ai(2) ai(3)]`.

`flag = islinphase(d)` returns `true` if the digital filter, `d`, has linear phase. Use `designfilt` to generate `d` based on frequency-response specifications.

`flag = islinphase(...,tol)` uses the tolerance, `tol`, to determine when two numbers are close enough to be considered equal. If not specified, `tol`, defaults to $\text{eps}^{(2/3)}$.

`flag = islinphase(h)` determines if the `dfilt` filter object `h` has linear phase.

Examples

Linear and Nonlinear Phase

Use the window method to design a tenth-order lowpass FIR filter with normalized cutoff frequency 0.55. Verify that the filter has linear phase.

```
d = designfilt('lowpassfir','DesignMethod','window', ...  
              'FilterOrder',10,'CutoffFrequency',0.55);  
flag = islinphase(d)
```

```
flag = logical  
      1
```

```
[phs,w] = phasez(d);
```

```
plot(w/pi,phs)  
xlabel('Frequency \omega/\pi')  
ylabel('Phase')
```

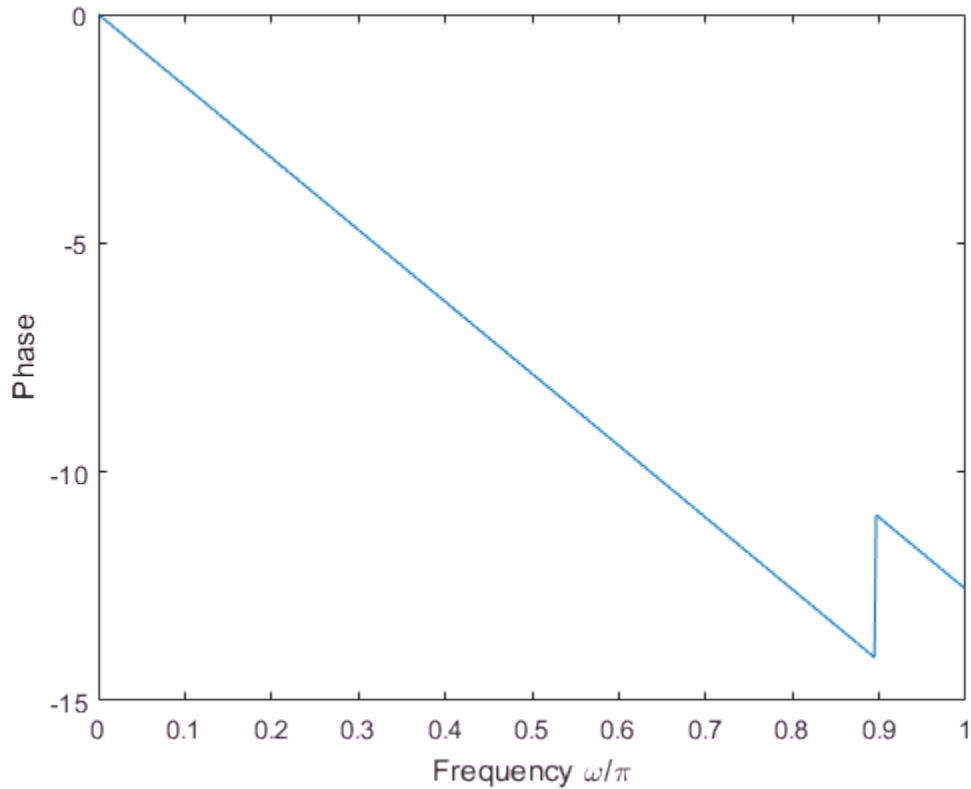

IIR filters in general do not have linear phase. Verify the statement by constructing eighth-order Butterworth, Chebyshev, and elliptic filters with similar specifications.

```
ord = 8;  
Wcut = 0.35;  
atten = 20;  
ripp1 = 1;  
  
[zb,pb,kb] = butter(ord,Wcut);  
sosb = zp2sos(zb,pb,kb);  
  
[zc,pc,kc] = cheby1(ord,ripp1,Wcut);  
sosC = zp2sos(zc,pc,kc);
```

```
[zd,pd,kd] = cheby2(ord,atten,Wcut);
sosd = zp2sos(zd,pd,kd);
```

```
[ze,pe,ke] = ellip(ord,ripp1,atten,Wcut);
sose = zp2sos(ze,pe,ke);
```

Plot the phase responses of the filters. Determine whether they have linear phase.

```
fv = fvtool(sosb,sosc,sosd,sose,'Analysis','phase');
legend(fv,'Butterworth','Chebyshev I','Chebyshev II','Elliptic')
```

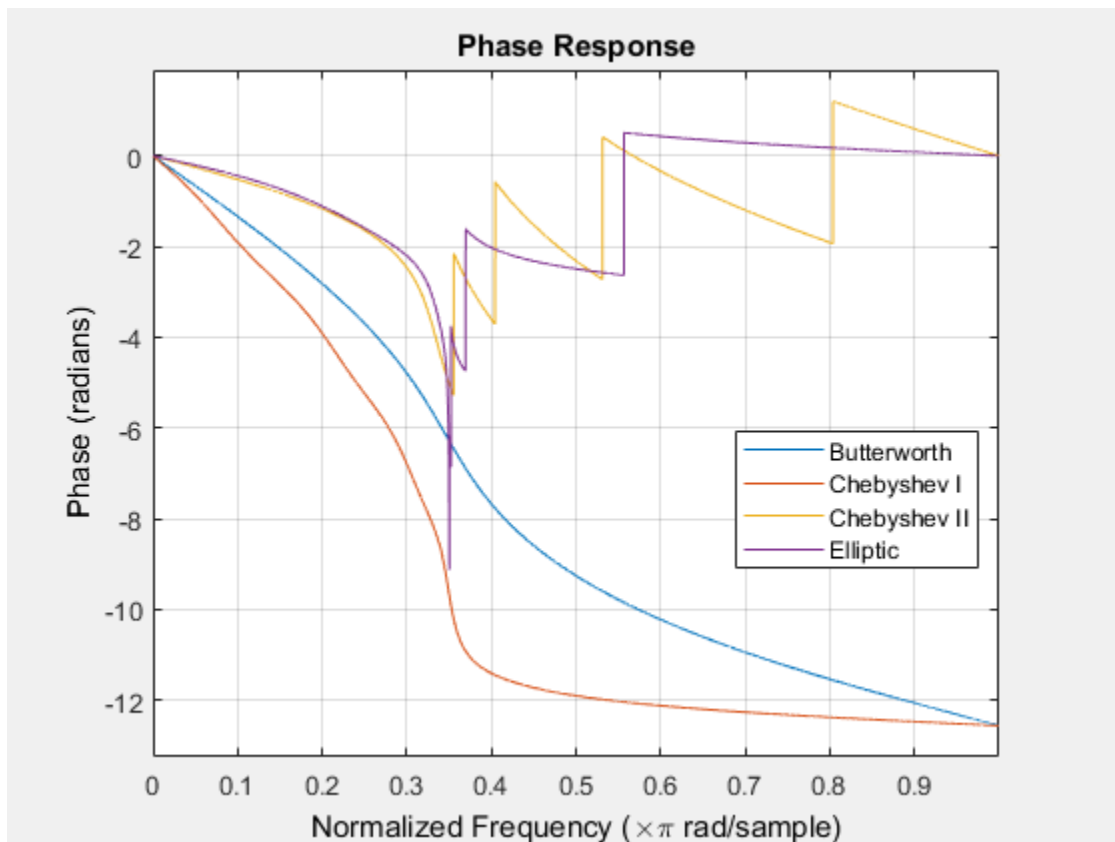

```
phs = [islinphase(sosb) islinphase(sosc) ...
       islinphase(sosd) islinphase(sose)]
```

```
phs = 1×4 logical array  
    0    0    0    0
```

See Also

`designfilt` | `digitalFilter` | `isallpass` | `ismaxphase` | `isminphase` | `isstable`

Introduced in R2013a

isminphase

Determine whether filter is minimum phase

Syntax

```
flag = isminphase(b,a)
flag = isminphase(sos)
flag = isminphase(d)
flag = isminphase(...,tol)
flag = isminphase(h)
```

Description

A filter is *minimum phase* when all the zeros of its transfer function are on or inside the unit circle, or the numerator is a scalar. An equivalent definition for a minimum phase filter is a causal and stable system with a causal and stable inverse.

`flag = isminphase(b,a)` returns a logical output, `flag`, equal to `true` if the filter specified by numerator coefficients, `b`, and denominator coefficients, `a`, is a minimum phase filter.

`flag = isminphase(sos)` returns `true` if the filter specified by second order sections matrix, `sos`, is minimum phase. `sos` is a K -by-6 matrix, where the number of sections, K , must be greater than or equal to 2. Each row of `sos` corresponds to the coefficients of a second order (biquad) filter. The i th row of the `sos` matrix corresponds to `[bi(1) bi(2) bi(3) ai(1) ai(2) ai(3)]`.

`flag = isminphase(d)` returns `true` if the digital filter, `d`, has minimum phase. Use `designfilt` to generate `d` based on frequency-response specifications.

`flag = isminphase(...,tol)` uses the tolerance, `tol`, to determine when two numbers are close enough to be considered equal. If not specified, `tol`, defaults to $\text{eps}^{(2/3)}$.

`flag = isminphase(h)` determines if the `dfilt` filter object `h` is minimum phase.

Examples

Minimum Phase Filters

Design a sixth-order lowpass Butterworth IIR filter using second order sections. Specify a normalized 3-dB frequency of 0.15. Check if the filter has minimum phase.

```
[z,p,k] = butter(6,0.15);  
SOS = zp2sos(z,p,k);  
min_flag = isminphase(SOS)
```

```
min_flag = logical  
         1
```

Redesign the filter using `designfilt`. Check that the zeros and poles of the transfer function are on or within the unit circle.

```
d = designfilt('lowpassiir','DesignMethod','butter','FilterOrder',6, ...  
              'HalfPowerFrequency',0.25);
```

```
d_flag = isminphase(d)
```

```
d_flag = logical  
         1
```

```
zplane(d)
```

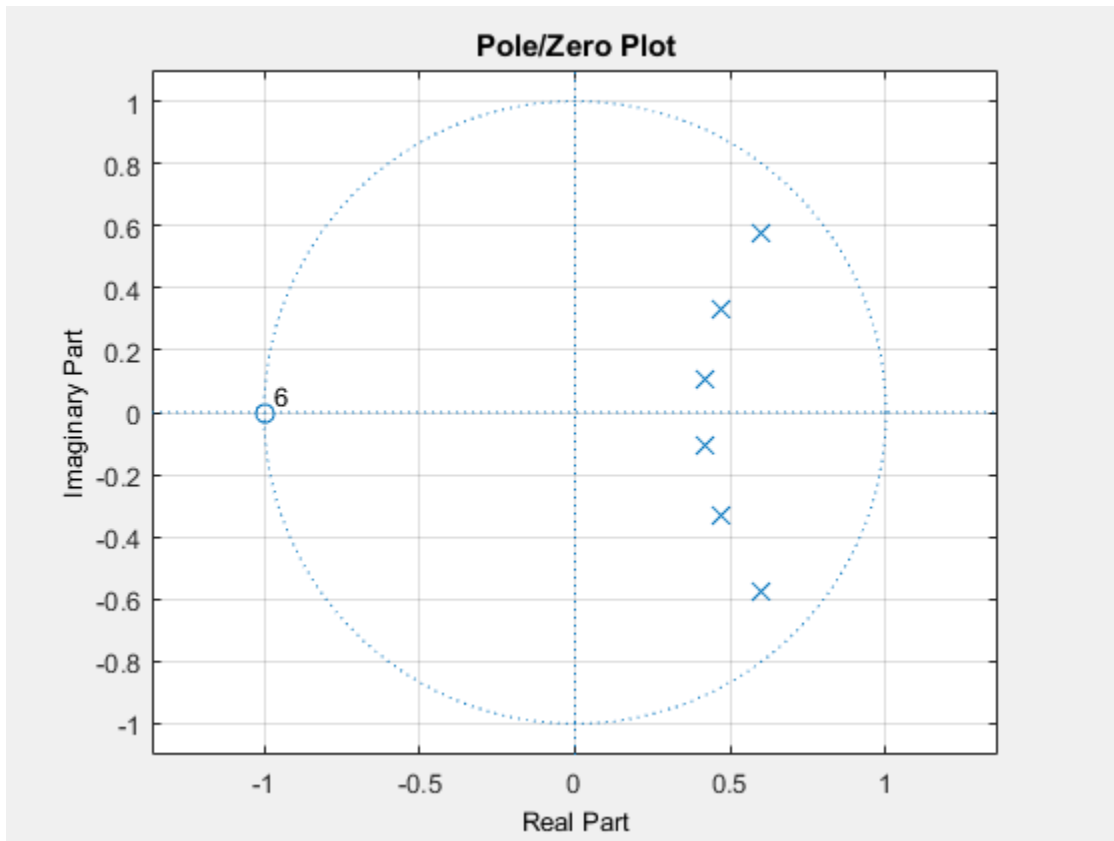

Given a filter defined with a set of single-precision numerator and denominator coefficients, check if it has minimum phase for different tolerance values.

```
b = single([1 1.00001]);
a = single([1 0.45]);
min_flag1 = isminphase(b,a)
```

```
min_flag1 = logical
    0
```

```
min_flag2 = isminphase(b,a,1e-3)
```

```
min_flag2 = logical
    1
```

See Also

`designfilt` | `digitalFilter` | `isallpass` | `islinphase` | `ismaxphase` | `isstable`

Introduced in R2013a

ismaxphase

Determine whether filter is maximum phase

Syntax

```
flag = ismaxphase(b,a)
flag = ismaxphase(sos)
flag = ismaxphase(d)
flag = ismaxphase(...,tol)
flag = ismaxphase(h)
```

Description

`flag = ismaxphase(b,a)` returns a logical output, `flag`, equal to `true` if the filter specified by numerator coefficients, `b`, and denominator coefficients, `a`, is a maximum phase filter.

`flag = ismaxphase(sos)` returns `true` if the filter specified by second order sections matrix, `sos`, is a maximum phase filter. `sos` is a K -by-6 matrix, where the number of sections, K , must be greater than or equal to 2. Each row of `sos` corresponds to the coefficients of a second order (biquad) filter. The i th row of the `sos` matrix corresponds to `[bi(1) bi(2) bi(3) ai(1) ai(2) ai(3)]`.

`flag = ismaxphase(d)` returns `true` if the digital filter, `d`, has maximum phase. Use `designfilt` to generate `d` based on frequency-response specifications.

`flag = ismaxphase(...,tol)` uses the tolerance, `tol`, to determine when two numbers are close enough to be considered equal. If not specified, `tol`, defaults to $\text{eps}^{(2/3)}$.

`flag = ismaxphase(h)` returns `true` if the `dfilt` filter object `h` is a maximum phase filter.

Examples

Maximum- and Minimum-Phase Filters

Design maximum-phase and minimum-phase lattice filters and verify their phase type.

```
k = [1/6 1/1.4];  
bmax = latc2tf(k, 'max');  
bmin = latc2tf(k, 'min');  
max_flag = ismaxphase(bmax)
```

```
max_flag = logical  
1
```

```
min_flag = isminphase(bmin)
```

```
min_flag = logical  
1
```

Given a filter defined with a set of single precision numerator and denominator coefficients, check if it is maximum phase for different values of the tolerance.

```
b = single([1 -0.9999]);  
a = single([1 0.45]);  
max_flag1 = ismaxphase(b,a)
```

```
max_flag1 = logical  
0
```

```
max_flag2 = ismaxphase(b,a,1e-3)
```

```
max_flag2 = logical  
1
```

See Also

[designfilt](#) | [digitalFilter](#) | [isallpass](#) | [islinphase](#) | [isminphase](#) | [isstable](#)

Introduced in R2013a

issingle

Determine if digital filter coefficients are single precision

Syntax

```
flag = issingle(d)
```

Description

`flag = issingle(d)` returns `true` if the coefficients of a digital filter, `d`, are single precision.

Examples

Single- and Double-Precision Filters

Use `designfilt` to design a 6th-order highpass IIR filter. Specify a normalized passband frequency of 0.6π rad/sample. Convert it to a single-precision filter. Identify the precision in each case.

```
fd = designfilt('highpassiir', 'FilterOrder', 6, 'PassbandFrequency', 0.6);  
isd = issingle(fd)
```

```
isd = logical  
     0
```

```
fs = single(fd);  
iss = issingle(fs)
```

```
iss = logical  
     1
```

Input Arguments

d — Digital filter

`digitalFilter` object

Digital filter, specified as a `digitalFilter` object. Use `designfilt` to generate **d** based on frequency-response specifications. If you want a single-precision filter, apply `single` to the output of `designfilt`.

Example: `d = designfilt('lowpassiir','FilterOrder',3,'HalfPowerFrequency',0.5)` specifies a third-order Butterworth filter with normalized 3-dB frequency 0.5π rad/sample.

Output Arguments

flag — Type identification

logical scalar

Type identification, returned as a logical scalar.

See Also

See Also

`designfilt` | `digitalFilter` | `double` | `isdouble` | `single`

Introduced in R2014a

isstable

Determine whether filter is stable

Syntax

```
flag = isstable(b,a)
flag = isstable(sos)
flag = isstable(d)
flag = isstable(h)
```

Description

`flag = isstable(b,a)` returns a logical output, `flag`, equal to `true` if the filter specified by numerator coefficients, `b`, and denominator coefficients, `a`, is a stable filter. If the poles lie on or outside the circle, `isstable` returns `false`. If the poles are inside the circle, `isstable` returns `true`.

`flag = isstable(sos)` returns `true` if the filter specified by second order sections matrix, `sos`, is stable. `sos` is a K -by-6 matrix, where the number of sections, K , must be greater than or equal to 2. Each row of `sos` corresponds to the coefficients of a second order (biquad) filter. The i th row of the `sos` matrix corresponds to [`bi(1) bi(2) bi(3) ai(1) ai(2) ai(3)`].

`flag = isstable(d)` returns `true` if the digital filter, `d`, is stable. Use `designfilt` to generate `d` based on frequency-response specifications.

`flag = isstable(h)` returns `true` if the `dfilt` filter object `h` is stable.

Examples

Filter Stability

Design a sixth-order Butterworth highpass IIR filter using second order sections. Specify a normalized 3-dB frequency of 0.7. Determine if the filter is stable.

```
[z,p,k] = butter(6,0.7,'high');
```

```
SOS = zp2sos(z,p,k);
flag = isstable(SOS)
```

```
flag = logical
      1
```

```
zplane(z,p)
```

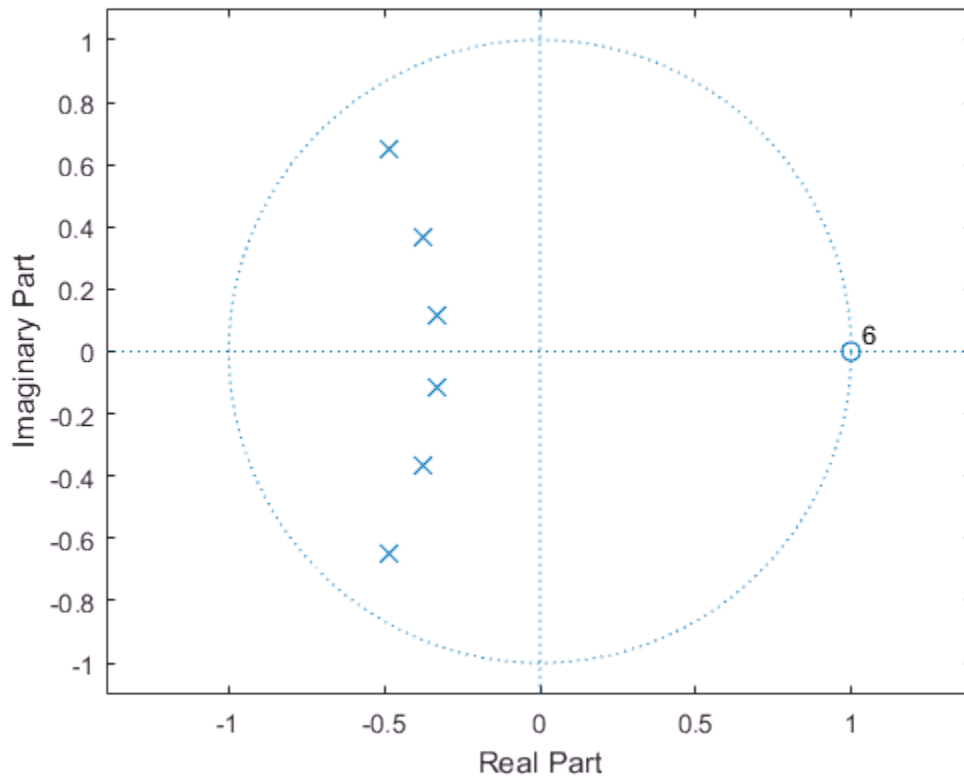

Redesign the filter using `designfilt` and check it for stability.

```
d = designfilt('highpassiir', 'DesignMethod', 'butter', 'FilterOrder', 6, ...
              'HalfPowerFrequency', 0.7);
dflg = isstable(d)
```

```
dflg = logical
      1
```

```
zplane(d)
```

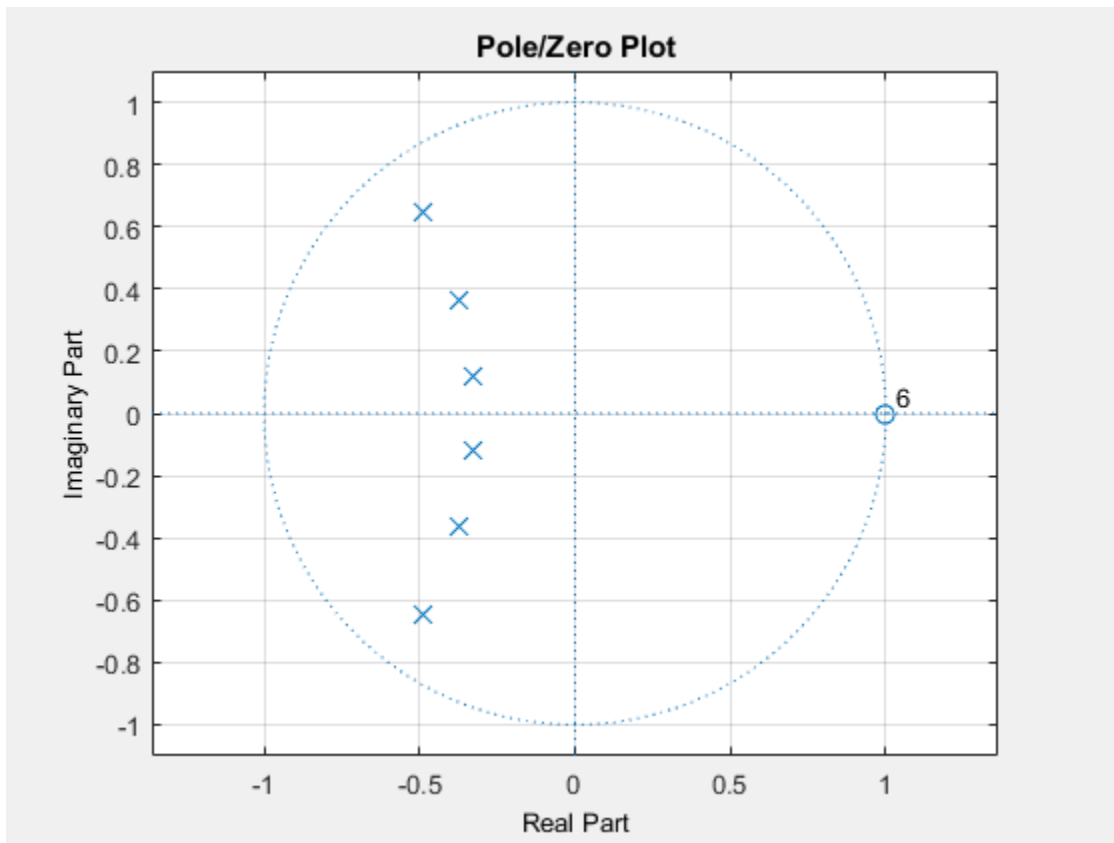

Create a filter and determine its stability at double and single precision.

```
b = [1 -0.5];
a = [1 -0.999999999];
act_flag1 = isstable(b,a)

act_flag1 = logical
      1
```

```
act_flag2 = isstable(single(b),single(a))
```

```
act_flag2 = logical  
0
```

See Also

`designfilt` | `digitalFilter` | `isallpass` | `islinphase` | `ismaxphase` | `isminphase`
| `zplane`

Introduced in R2013a

is2rc

Convert inverse sine parameters to reflection coefficients

Syntax

```
k = is2rc(isin)
```

Description

`k = is2rc(isin)` returns a vector of reflection coefficients, `k`, from a vector of inverse sine parameters, `isin`.

Examples

Compute Reflection Coefficients

Define a vector, `isin`, of inverse sine parameters and determine the corresponding reflection coefficients.

```
isin = [0.2000 0.8727 0.0020 0.0052 -0.0052];  
k = is2rc(isin)  
  
k =  
  
    0.3090    0.9801    0.0031    0.0082   -0.0082
```

References

- [1] Deller, John R., John G. Proakis, and John H. L. Hansen. *Discrete-Time Processing of Speech Signals*. New York: Macmillan, 1993.

See Also

`ac2rc` | `lar2rc` | `poly2rc` | `rc2is`

Introduced before R2006a

kaiser

Kaiser window

Syntax

```
w = kaiser(L,beta)
```

Description

`w = kaiser(L,beta)` returns an L-point Kaiser window in the column vector `w`. `beta` is the Kaiser window parameter that affects the sidelobe attenuation of the Fourier transform of the window. The default value for `beta` is 0.5.

Examples

Kaiser Window

Create a 200-point Kaiser window with a beta of 2.5. Display the result using `wvtool`.

```
w = kaiser(200,2.5);  
wvtool(w)
```

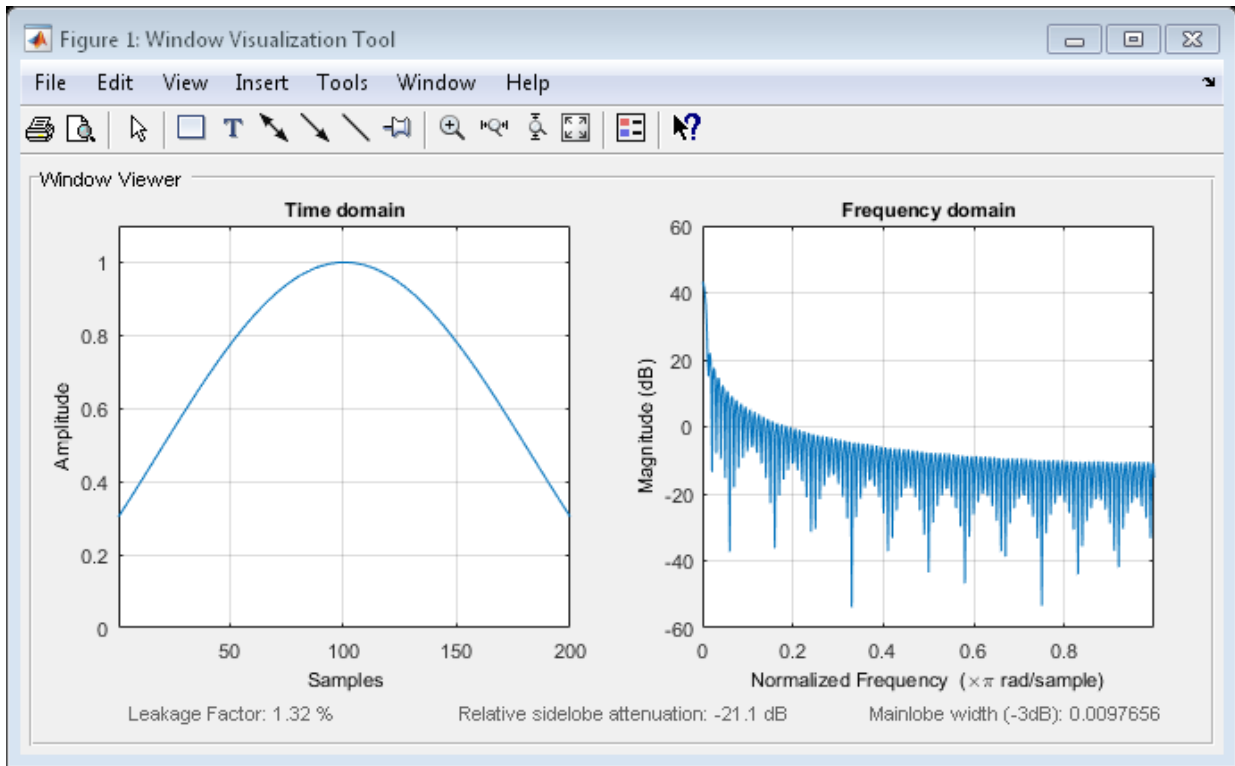

Algorithms

The coefficients of a Kaiser window are computed from the following equation:

$$w(n) = \frac{I_0 \left(\beta \sqrt{1 - \left(\frac{n - N/2}{N/2} \right)^2} \right)}{I_0(\beta)}, \quad 0 \leq n \leq N,$$

where I_0 is the zeroth-order modified Bessel function of the first kind. The length $L = N + 1$. Thus `kaiser(L, beta)` is equivalent to

```
besseli(0,beta*sqrt(1-(((0:L-1)-(L-1)/2)/((L-1)/2)).^2))/
besseli(0,beta).
```

To obtain a Kaiser window that designs an FIR filter with sidelobe attenuation of a dB, use the following β .

$$\beta = \begin{cases} 0.1102(\alpha - 8.7), & \alpha > 50 \\ 0.5842(\alpha - 21)^{0.4} + 0.07886(\alpha - 21), & 50 \geq \alpha \geq 21 \\ 0, & \alpha < 21 \end{cases}$$

Increasing β widens the mainlobe and decreases the amplitude of the sidelobes (i.e., increases the attenuation).

References

- [1] Kaiser, James F. "Nonrecursive Digital Filter Design Using the I_0 -Sinh Window Function." *Proceedings of the 1974 IEEE International Symposium on Circuits and Systems*. April, 1974, pp.20–23.
- [2] Digital Signal Processing Committee of the IEEE Acoustics, Speech, and Signal Processing Society, eds. *Selected Papers in Digital Signal Processing*. Vol. II. New York: IEEE Press, 1976.
- [3] Oppenheim, Alan V., Ronald W. Schaffer, and John R. Buck. *Discrete-Time Signal Processing*. Upper Saddle River, NJ: Prentice Hall, 1999, p. 474.

Extended Capabilities

C/C++ Code Generation

Generate C and C++ code using MATLAB® Coder™.

See Also

See Also

Apps

Window Designer

Functions

`chebwin` | `gausswin` | `kaiserord` | `tukeywin` | `window` | `wvtool`

Introduced before R2006a

kaiserord

Kaiser window FIR filter design estimation parameters

Syntax

```
[n,Wn,beta,ftype] = kaiserord(f,a,dev)
[n,Wn,beta,ftype] = kaiserord(f,a,dev,fs)
c = kaiserord(f,a,dev,fs,'cell')
```

Description

`kaiserord` returns a filter order `n` and `beta` parameter to specify a Kaiser window for use with the `fir1` function. Given a set of specifications in the frequency domain, `kaiserord` estimates the minimum FIR filter order that will approximately meet the specifications. `kaiserord` converts the given filter specifications into passband and stopband ripples and converts cutoff frequencies into the form needed for windowed FIR filter design.

`[n,Wn,beta,ftype] = kaiserord(f,a,dev)` finds the approximate order `n`, normalized frequency band edges `Wn`, and weights that meet input specifications `f`, `a`, and `dev`. `f` is a vector of band edges and `a` is a vector specifying the desired amplitude on the bands defined by `f`. The length of `f` is twice the length of `a`, minus 2. Together, `f` and `a` define a desired piecewise constant response function. `dev` is a vector the same size as `a` that specifies the maximum allowable error or deviation between the frequency response of the output filter and its desired amplitude, for each band. The entries in `dev` specify the passband ripple and the stopband attenuation. You specify each entry in `dev` as a positive number, representing absolute filter gain (not in decibels).

Note If, in the vector `dev`, you specify unequal deviations across bands, the minimum specified deviation is used, since the Kaiser window method is constrained to produce filters with minimum deviation in all of the bands.

`fir1` can use the resulting order `n`, frequency vector `Wn`, multiband magnitude type `ftype`, and the Kaiser window parameter `beta`. The `ftype` output argument is intended

for use with `fir1`; it is equal to `'high'` for a highpass filter and `'stop'` for a bandstop filter. For multiband filters, it can be equal to `'DC-0'` when the first band is a stopband (starting at $f = 0$) or `'DC-1'` when the first band is a passband.

To design an FIR filter `b` that approximately meets the specifications given by `kaiser` parameters `f`, `a`, and `dev`, use the following command.

```
b = fir1(n,Wn,kaiser(n+1,beta),ftype,'noscale')
```

`[n,Wn,beta,ftype] = kaiserord(f,a,dev,fs)` uses a sampling frequency `fs` in Hz. If you don't specify the argument `fs`, or if you specify it as the empty vector `[]`, it defaults to 2 Hz, and the Nyquist frequency is 1 Hz. You can use this syntax to specify band edges scaled to a particular application's sampling frequency. The frequency band edges in `f` must be from 0 to `fs/2`.

`c = kaiserord(f,a,dev,fs,'cell')` is a cell-array whose elements are the parameters to `fir1`.

Note In some cases, `kaiserord` underestimates or overestimates the order `n`. If the filter does not meet the specifications, try a higher order such as `n+1`, `n+2`, and so on, or a try lower order.

Results are inaccurate if the cutoff frequencies are near 0 or the Nyquist frequency, or if `dev` is large (greater than 10%).

Examples

Kaiser Window Lowpass Filter Design

Design a lowpass filter with passband defined from 0 to 1 kHz and stopband defined from 1500 Hz to 4 kHz. Specify a passband ripple of 5% and a stopband attenuation of 40 dB.

```
fsamp = 8000;  
fcuts = [1000 1500];  
mags = [1 0];  
devs = [0.05 0.01];  
  
[n,Wn,beta,ftype] = kaiserord(fcuts,mags,devs,fsamp);  
hh = fir1(n,Wn,ftype,kaiser(n+1,beta),'noscale');  
  
freqz(hh)
```

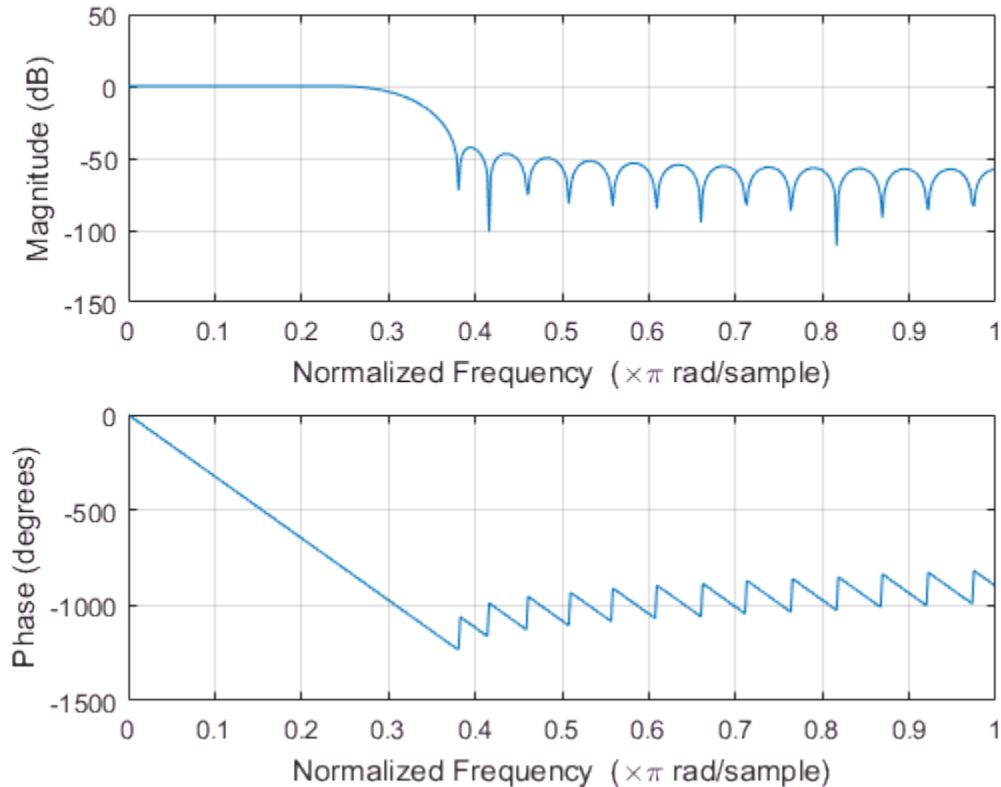
Kaiser Window Bandpass Filter Design

Design an odd-length bandpass filter. Note that odd length means even order, so the input to `fir1` must be an even integer.

```
fsamp = 8000;
fcuts = [1000 1300 2210 2410];
mags = [0 1 0];
devs = [0.01 0.05 0.01];

[n,Wn,beta,ftype] = kaiserord(fcuts,mags,devs,fsamp);
n = n + rem(n,2);
hh = fir1(n,Wn,ftype,kaiser(n+1,beta),'noscale');
```

```
[H,f] = freqz(hh,1,1024,fsamp);  
plot(f,abs(H))  
grid
```

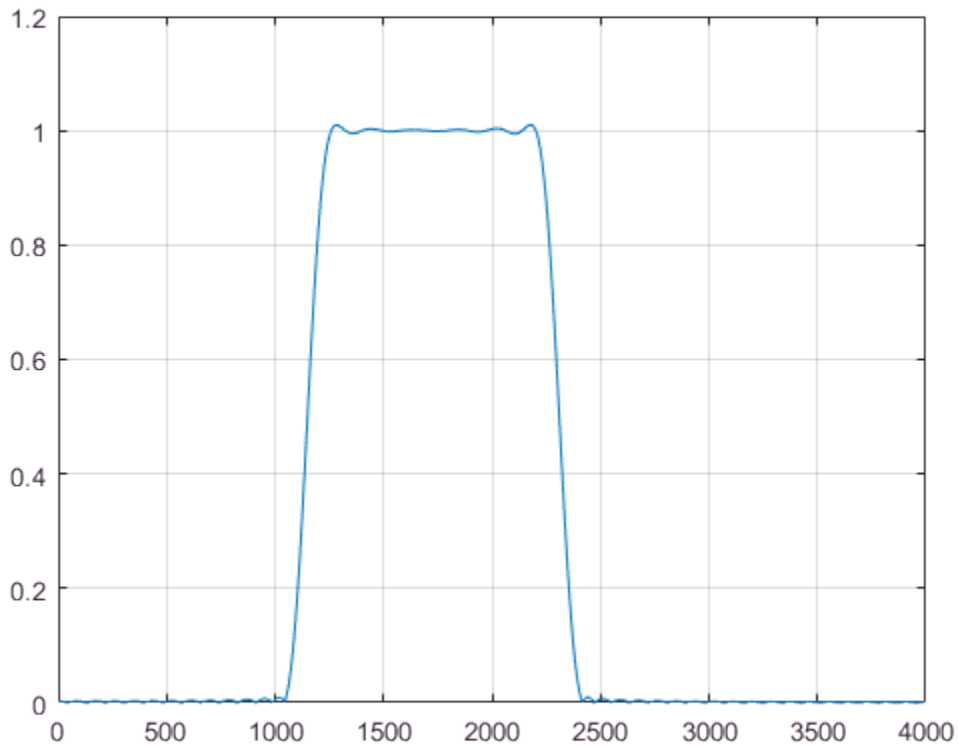

Lowpass Filter Design with 'cell' Option

Design a lowpass filter with a passband cutoff of 1500 Hz, a stopband cutoff of 2000 Hz, a passband ripple of 0.01, a stopband ripple of 0.1, and a sample rate of 8000 Hz. Design an equivalent filter using the 'cell' option.

```
[n,Wn,beta,fstype] = kaiserord([1500 2000],[1 0],...  
    [0.01 0.1],8000);
```

```
b = fir1(n,Wn,ftype,kaiser(n+1,beta),'noscale');  
  
c = kaiserord([1500 2000],[1 0],[0.01 0.1],8000,'cell');  
bcell = fir1(c{:});  
  
hfvt = fvtool(b,1,bcell,1);  
legend(hfvt,'b','bcell')
```

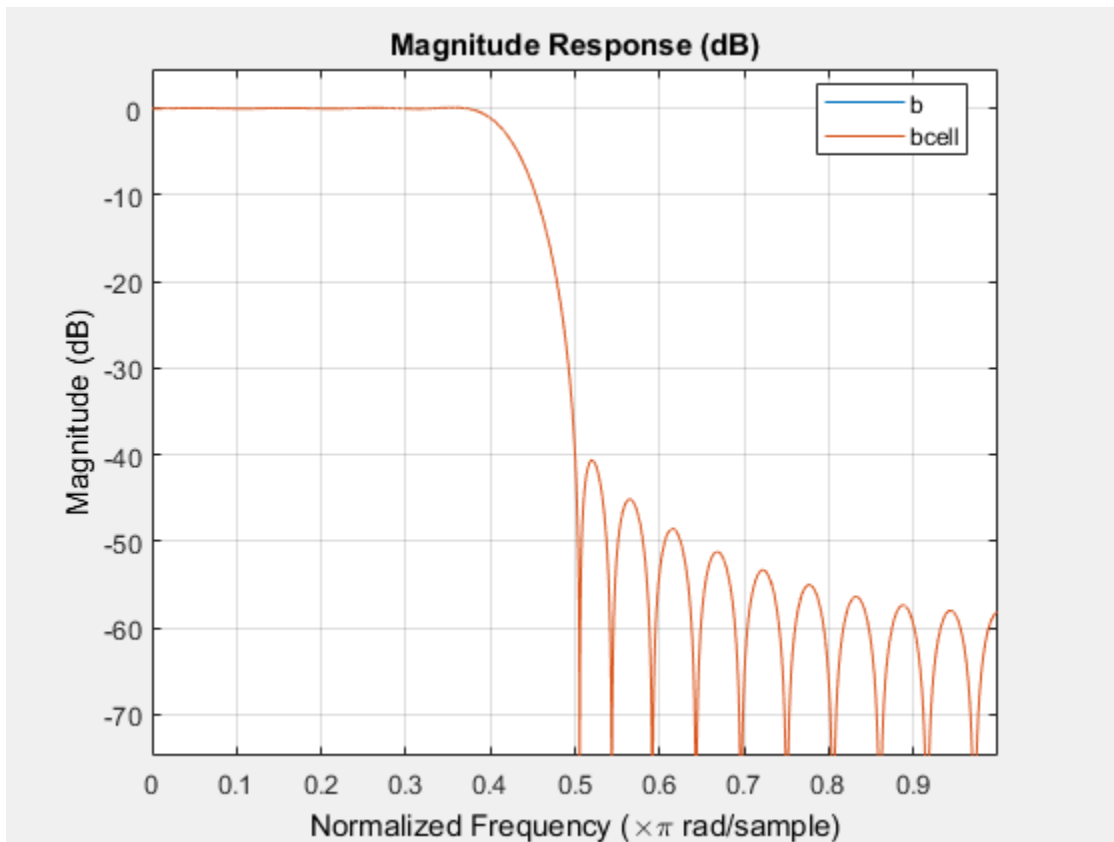

Tips

Be careful to distinguish between the meanings of filter length and filter order. The filter *length* is the number of impulse response samples in the FIR filter. Generally,

the impulse response is indexed from $n = 0$ to $n = L-1$ where L is the filter length. The filter *order* is the highest power in a z -transform representation of the filter. For an FIR transfer function, this representation is a polynomial in z , where the highest power is z^{L-1} and the lowest power is z^0 . The filter order is one less than the length ($L-1$) and is also equal to the number of zeros of the z polynomial.

Algorithms

`kaiserord` uses empirically derived formulas for estimating the orders of lowpass filters, as well as differentiators and Hilbert transformers. Estimates for multiband filters (such as bandpass filters) are derived from the lowpass design formulas.

The design formulas that underlie the Kaiser window and its application to FIR filter design are

$$\beta = \begin{cases} 0.1102(\alpha - 8.7), & \alpha > 50 \\ 0.5842(\alpha - 21)^{0.4} + 0.07886(\alpha - 21), & 21 \leq \alpha \leq 50 \\ 0, & \alpha < 21 \end{cases}$$

where $\alpha = -20\log_{10}\delta$ is the stopband attenuation expressed in decibels (recall that $\delta_p = \delta_s$ is required).

The design formula is

$$n = \frac{\alpha - 7.95}{2.285(\Delta\omega)}$$

where n is the filter order and $\Delta\omega$ is the width of the smallest transition region.

References

- [1] Kaiser, James F. “Nonrecursive Digital Filter Design Using the I_0 -sinh Window Function.” *Proceedings of the 1974 IEEE International Symposium on Circuits and Systems*. 1974, pp.20–23.

- [2] Digital Signal Processing Committee of the IEEE Acoustics, Speech, and Signal Processing Society, eds. *Selected Papers in Digital Signal Processing*. Vol. II. New York: IEEE Press, 1976, pp.123–126.
- [3] Oppenheim, Alan V., Ronald W. Schaffer, and John R. Buck. *Discrete-Time Signal Processing*. Upper Saddle River, NJ: Prentice Hall, 1999.

Extended Capabilities

C/C++ Code Generation

Generate C and C++ code using MATLAB® Coder™.

See Also

[fir1](#) | [kaiser](#) | [firpmord](#)

Introduced before R2006a

kaiserwin

Kaiser window filter from specification object

Syntax

```
h = design(d, 'kaiserwin')  
h = design(d, 'kaiserwin', Name, Value)
```

Description

`h = design(d, 'kaiserwin')` designs a digital filter using a Kaiser window. For `kaiserwin` to work properly, the filter order in the specifications object must be even. In addition, higher order filters (filter order greater than 120) tend to be more accurate for smaller transition widths. `kaiserwin` returns a warning when your filter order may be too low to design your filter accurately.

`h = design(d, 'kaiserwin', Name, Value)` returns a filter designed with the Kaiser window technique and with design options specified as `Name, Value` pairs.

To determine the available design options, use `designmethods` with the specification object and the design method as input arguments as shown.

```
designopts(d, 'method')
```

For complete help about using `kaiserwin`, refer to the command line help system. For example, to get specific information about using `kaiserwin` with `d`, the specification object, enter the following at the MATLAB prompt.

```
help(d, 'kaiserwin')
```

Examples

Design Filter Using Kaiser Window

Design a direct-form FIR filter starting from the default lowpass filter specification object. Use a Kaiser window for the design. Visualize the magnitude response.

```
d = fdesign.lowpass;  
Hd = design(d, 'kaiserwin');  
  
fvtool(Hd)
```

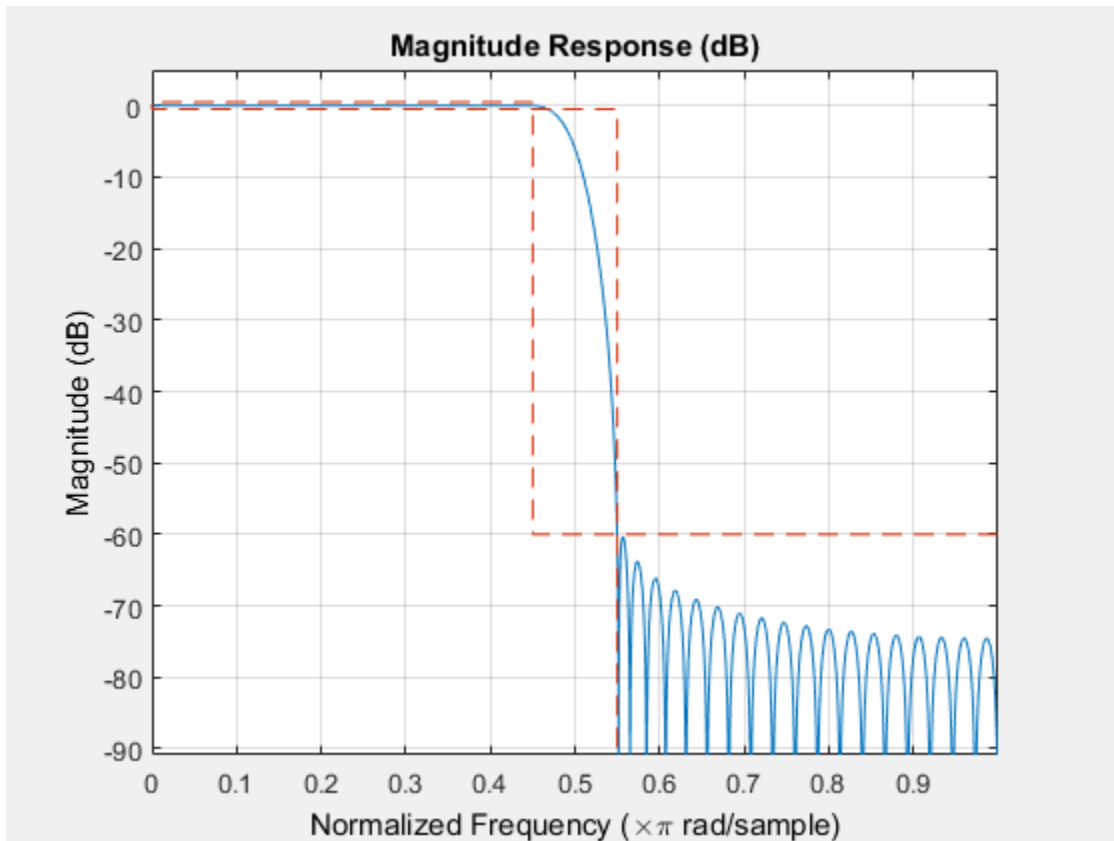

See Also

See Also

Apps
Filter Designer

Functions

designfilt | fdesign

Introduced in R2009a

lar2rc

Convert log area ratio parameters to reflection coefficients

Syntax

$k = \text{lar2rc}(g)$

Description

$k = \text{lar2rc}(g)$ returns a vector of reflection coefficients k from a vector of log area ratio parameters g .

Examples

Calculate Reflection Coefficients

Given a vector, g , of log area ratio parameters, determine the corresponding vector of reflection coefficients.

```
g = [0.6389 4.5989 0.0063 0.0163 -0.0163];
```

```
k = lar2rc(g)
```

```
k =
```

```
    0.3090    0.9801    0.0031    0.0081   -0.0081
```

References

[1] Deller, John R., John G. Proakis, and John H. L. Hansen. *Discrete-Time Processing of Speech Signals*. New York: Macmillan, 1993.

See Also

ac2rc | is2rc | poly2rc | rc2lar

Introduced before R2006a

latc2tf

Convert lattice filter parameters to transfer function form

Syntax

```
[num,den] = latc2tf(k,v)
[num,den] = latc2tf(k,'iioption')
num = latc2tf(k,'fioption')
```

Description

`[num,den] = latc2tf(k,v)` finds the transfer function numerator `num` and denominator `den` from the IIR lattice coefficients `k` and ladder coefficients `v`.

`[num,den] = latc2tf(k,'iioption')` produces an IIR filter transfer function according to the value of `'iioption'`:

- `'allpole'`: Produces an all-pole filter transfer function from the associated all-pole IIR lattice filter coefficients `k`.
- `'allpass'`: Produces an allpass filter transfer function from the associated allpass IIR lattice filter coefficients `k`.

`num = latc2tf(k,'fioption')` produces an FIR filter according to the value of `'fioption'`:

- `'min'`: Produces a minimum-phase FIR filter numerator from the associated minimum-phase FIR lattice filter coefficients `k`.
- `'max'`: Produces a maximum-phase FIR filter numerator from the associated maximum-phase FIR lattice filter coefficients `k`.
- `'FIR'`: Produces a general FIR filter numerator from the lattice filter coefficients `k` (this is equivalent to not specifying `'iioption'` or `'fioption'`).

See Also

latcfilt | tf2latc

Introduced before R2006a

latcfilt

Lattice and lattice-ladder filter implementation

Syntax

```
[f,g] = latcfilt(k,x)
[f,g] = latcfilt(k,v,x)
[f,g] = latcfilt(k,1,x)
[f,g,zf] = latcfilt(...,'ic',zi)
[f,g,zf] = latcfilt(...,dim)
```

Description

When filtering data, lattice coefficients can be used to represent

- FIR filters
- All-pole IIR filters
- Allpass IIR filters
- General IIR filters

`[f,g] = latcfilt(k,x)` filters `x` with the FIR lattice coefficients in the vector `k`. The forward lattice filter result is `f` and `g` is the backward filter result. If $|k| \leq 1$, `f` corresponds to the minimum-phase output, and `g` corresponds to the maximum-phase output.

If `k` and `x` are vectors, the result is a (signal) vector. Matrix arguments are permitted under the following rules:

- If `x` is a matrix and `k` is a vector, each column of `x` is processed through the lattice filter specified by `k`.
- If `x` is a vector and `k` is a matrix, each column of `k` is used to filter `x`, and a signal matrix is returned.
- If `x` and `k` are both matrices with the same number of columns, then the i th column of `k` is used to filter the i th column of `x`. A signal matrix is returned.

`[f,g] = latcfilt(k,v,x)` filters `x` with the IIR lattice coefficients `k` and ladder coefficients `v`. Both `k` and `v` must be vectors, while `x` can be a signal matrix.

`[f,g] = latcfilt(k,1,x)` filters `x` with the IIR lattice specified by `k`, where `k` and `x` can be vectors or matrices. `f` is the all-pole lattice filter result and `g` is the allpass filter result.

`[f,g,zf] = latcfilt(...,'ic',zi)` accepts a length-`k` vector `zi` specifying the initial condition of the lattice states. Output `zf` is a length-`k` vector specifying the final condition of the lattice states.

`[f,g,zf] = latcfilt(...,dim)` filters `x` along the dimension `dim`. To specify a `dim` value, the FIR lattice coefficients `k` must be a vector and you must specify all previous input parameters in order. Use the empty vector `[]` for any parameters you do not want to specify. `zf` returns the final conditions in columns, regardless of the shape of `x`.

Examples

FIR Lattice Filter

Generate a signal with 512 samples of white Gaussian noise.

```
x = randn(512,1);
```

Filter the data with an FIR lattice filter. Specify the reflection coefficients so that the lattice filter is equivalent to a 3rd-order moving average filter.

```
[f,g] = latcfilt([1/2 1],x);
```

Plot the maximum- and minimum-phase outputs of the lattice filter in separate plots

```
subplot(2,1,1)
plot(f)
title('Maximum-Phase Output')

subplot(2,1,2)
plot(g)
title('Minimum-Phase Output')
```

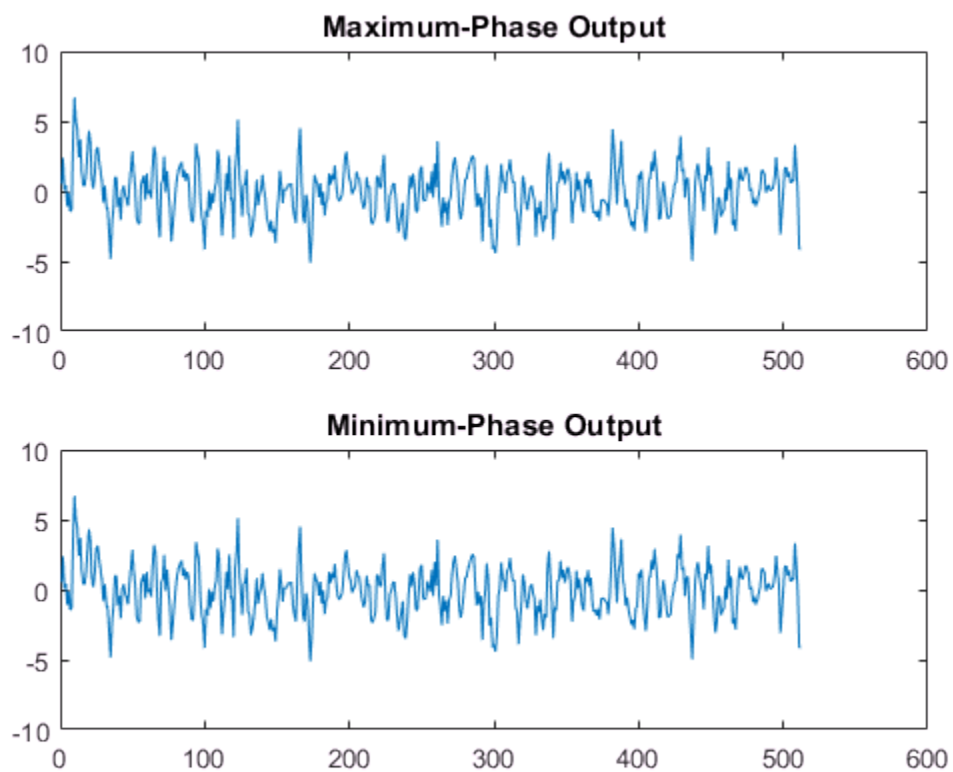

See Also

[filter](#) | [latc2tf](#) | [tf2latc](#)

Introduced before R2006a

levinson

Levinson-Durbin recursion

Syntax

```
a = levinson(r)
a = levinson(r,n)
[a,e] = levinson(r,n)
[a,e,k] = levinson(r,n)
```

Description

The Levinson-Durbin recursion is an algorithm for finding an all-pole IIR filter with a prescribed deterministic autocorrelation sequence. It has applications in filter design, coding, and spectral estimation. The filter that `levinson` produces is minimum phase.

`a = levinson(r)` finds the coefficients of a `length(r) - 1` order autoregressive linear process which has `r` as its autocorrelation sequence. `r` is a real or complex deterministic autocorrelation sequence. If `r` is a matrix, `levinson` finds the coefficients for each column of `r` and returns them in the rows of `a`. `n=length(r) - 1` is the default order of the denominator polynomial $A(z)$; that is, `a = [1 a(2) ... a(n+1)]`. The filter coefficients are ordered in descending powers of z^{-1} .

$$H(z) = \frac{1}{A(z)} = \frac{1}{1 + a(2)z^{-1} + \dots + a(n+1)z^{-n}}$$

`a = levinson(r,n)` returns the coefficients for an autoregressive model of order `n`.

`[a,e] = levinson(r,n)` returns the prediction error, `e`, of order `n`.

`[a,e,k] = levinson(r,n)` returns the reflection coefficients `k` as a column vector of length `n`.

Note `k` is computed internally while computing the `a` coefficients, so returning `k` simultaneously is more efficient than converting `a` to `k` with `tf2latc`.

Examples

Autoregressive Process Coefficients

Estimate the coefficients of an autoregressive process given by

$$x(n) = 0.1x(n-1) - 0.8x(n-2) + w(n).$$

```
a = [1 0.1 -0.8];
```

Generate a realization of the process by filtering white noise of variance 0.4.

```
rng('default')
v = 0.4;
w = sqrt(v)*randn(15000,1);
x = filter(1,a,w);
```

Estimate the correlation function. Discard the correlation values at negative lags. Use the Levinson-Durbin recursion to estimate the model coefficients.

```
[r,lg] = xcorr(x,'biased');
r(lg<0) = [];
```

```
ar = levinson(r,numel(a)-1)
```

```
ar =
```

```
1.0000    0.0957   -0.8026
```

Algorithms

levinson solves the symmetric Toeplitz system of linear equations

$$\begin{bmatrix} r(1) & r(2)^* & \cdots & r(n)^* \\ r(2) & r(1) & \cdots & r(n-1)^* \\ \vdots & \ddots & \ddots & \vdots \\ r(n) & \cdots & r(2) & r(1) \end{bmatrix} \begin{bmatrix} a(2) \\ a(3) \\ \vdots \\ a(n+1) \end{bmatrix} = \begin{bmatrix} -r(2) \\ -r(3) \\ \vdots \\ -r(n+1) \end{bmatrix}$$

where $\mathbf{r} = [r(1) \dots r(n+1)]$ is the input autocorrelation vector, and $r(i)^*$ denotes the complex conjugate of $r(i)$. The input \mathbf{r} is typically a vector of autocorrelation coefficients where lag 0 is the first element, $r(1)$.

Note: If \mathbf{r} is not a valid autocorrelation sequence, the `levinson` function might return NaNs even if the solution exists.

The algorithm requires $O(n^2)$ flops and is thus much more efficient than the MATLAB backslash command for large n . However, the `levinson` function uses `\` for low orders to provide the fastest possible execution.

References

- [1] Ljung, Lennart. *System Identification: Theory for the User*. 2nd Ed. Upper Saddle River, NJ: Prentice Hall, 1999.

Extended Capabilities

C/C++ Code Generation

Generate C and C++ code using MATLAB® Coder™.

Usage notes and limitations:

Code generation for this function requires the DSP System Toolbox software.

If specified, the order of recursion must be a constant. Expressions or variables are allowed if their values do not change.

See Also

`lpc` | `prony` | `rlevinson` | `stmcb` | `schurrc`

Introduced before R2006a

lp2bp

Transform lowpass analog filters to bandpass

Syntax

```
[bt,at] = lp2bp(b,a,Wo,Bw)
[At,Bt,Ct,Dt] = lp2bp(A,B,C,D,Wo,Bw)
```

Description

lp2bp transforms analog lowpass filter prototypes with a cutoff angular frequency of 1 rad/s into bandpass filters with desired bandwidth and center frequency. The transformation is one step in the digital filter design process for the `butter`, `cheby1`, `cheby2`, and `ellip` functions.

lp2bp can perform the transformation on two different linear system representations: transfer function form and state-space form. In both cases, the input system must be an analog filter prototype.

Transfer Function Form (Polynomial)

`[bt,at] = lp2bp(b,a,Wo,Bw)` transforms an analog lowpass filter prototype given by polynomial coefficients into a bandpass filter with center frequency `Wo` and bandwidth `Bw`. Row vectors `b` and `a` specify the coefficients of the numerator and denominator of the prototype in descending powers of `s`.

$$\frac{B(s)}{A(s)} = \frac{b(1)s^n + \dots + b(n)s + b(n+1)}{a(1)s^m + \dots + a(m)s + a(m+1)}$$

Scalars `Wo` and `Bw` specify the center frequency and bandwidth in units of rad/s. For a filter with lower band edge `w1` and upper band edge `w2`, use `Wo = sqrt(w1*w2)` and `Bw = w2 - w1`.

lp2bp returns the frequency transformed filter in row vectors `bt` and `at`.

State-Space Form

[At, Bt, Ct, Dt] = lp2bp(A, B, C, D, Wo, Bw) converts the continuous-time state-space lowpass filter prototype in matrices A, B, C, D shown below

$$\dot{x} = Ax + Bu$$

$$y = Cx + Du$$

into a bandpass filter with center frequency Wo and bandwidth Bw. For a filter with lower band edge w1 and upper band edge w2, use Wo = sqrt(w1*w2) and Bw = w2-w1.

The bandpass filter is returned in matrices At, Bt, Ct, Dt.

Algorithms

lp2bp is a highly accurate state-space formulation of the classic analog filter frequency transformation. Consider the state-space system

$$\dot{x} = Ax + Bu$$

$$y = Cx + Du$$

where u is the input, x is the state vector, and y is the output. The Laplace transform of the first equation (assuming zero initial conditions) is

$$sX(s) = AX(s) + BU(s)$$

Now if a bandpass filter is to have center frequency ω_0 and bandwidth B_w , the standard s -domain transformation is

$$s = Q(p^2 + 1) / p$$

where $Q = \omega_0/B_w$ and $p = s/\omega_0$. Substituting this for s in the Laplace transformed state-space equation, and considering the operator p as d/dt results in

$$Q\ddot{x} + Qx = \dot{A}x + B\dot{u}$$

or

$$Q\ddot{x} - \dot{A}x - B\dot{u} = -Qx$$

Now define

$$Q\dot{\omega} = -Qx$$

which, when substituted, leads to

$$Q\dot{x} = Ax + Q\omega + Bu$$

The last two equations give equations of state. Write them in standard form and multiply the differential equations by ω_0 to recover the time/frequency scaling represented by p and find state matrices for the bandpass filter:

```
Q = Wo/Bw; [ma,m] = size(A);
At = Wo*[A/Q eye(ma,m); -eye(ma,m) zeros(ma,m)];
Bt = Wo*[B/Q; zeros(ma,n)];
Ct = [C zeros(mc,ma)];
Dt = d;
```

If the input to `lp2bp` is in transfer function form, the function transforms it into state-space form before applying this algorithm.

See Also

`bilinear` | `lp2bs` | `lp2hp` | `lp2lp` | `impinvar`

Introduced before R2006a

lp2bs

Transform lowpass analog filters to bandstop

Syntax

```
[bt,at] = lp2bs(b,a,Wo,Bw)
[At,Bt,Ct,Dt] = lp2bs(A,B,C,D,Wo,Bw)
```

Description

lp2bs transforms analog lowpass filter prototypes with a cutoff angular frequency of 1 rad/s into bandstop filters with desired bandwidth and center frequency. The transformation is one step in the digital filter design process for the `butter`, `cheby1`, `cheby2`, and `ellip` functions.

lp2bs can perform the transformation on two different linear system representations: transfer function form and state-space form. In both cases, the input system must be an analog filter prototype.

Transfer Function Form (Polynomial)

`[bt,at] = lp2bs(b,a,Wo,Bw)` transforms an analog lowpass filter prototype given by polynomial coefficients into a bandstop filter with center frequency `Wo` and bandwidth `Bw`. Row vectors `b` and `a` specify the coefficients of the numerator and denominator of the prototype in descending powers of s .

$$\frac{B(s)}{A(s)} = \frac{b(1)s^n + \dots + b(n)s + b(n+1)}{a(1)s^m + \dots + a(m)s + a(m+1)}$$

Scalars `Wo` and `Bw` specify the center frequency and bandwidth in units of radians/second. For a filter with lower band edge `w1` and upper band edge `w2`, use `Wo = sqrt(w1*w2)` and `Bw = w2 - w1`.

lp2bs returns the frequency transformed filter in row vectors `bt` and `at`.

State-Space Form

[At, Bt, Ct, Dt] = lp2bs(A, B, C, D, Wo, Bw) converts the continuous-time state-space lowpass filter prototype in matrices A, B, C, D shown below

$$\begin{aligned}\dot{x} &= Ax + Bu \\ y &= Cx + Du\end{aligned}$$

into a bandstop filter with center frequency Wo and bandwidth Bw. For a filter with lower band edge w1 and upper band edge w2, use Wo = sqrt(w1*w2) and Bw = w2 - w1.

The bandstop filter is returned in matrices At, Bt, Ct, Dt.

Algorithms

lp2bs is a highly accurate state-space formulation of the classic analog filter frequency transformation. If a bandstop filter is to have center frequency ω_0 and bandwidth B_w , the standard s -domain transformation is

$$s = \frac{p}{Q(p^2 + 1)}$$

where $Q = \omega_0/B_w$ and $p = s/\omega_0$. The state-space version of this transformation is

$$\begin{aligned}Q &= \omega_0/B_w; \\ A_t &= [\omega_0/Q \cdot \text{inv}(A) \quad \omega_0 \cdot \text{eye}(ma); -\omega_0 \cdot \text{eye}(ma) \quad \text{zeros}(ma)]; \\ B_t &= -[\omega_0/Q \cdot (A \setminus B); \text{zeros}(ma, n)]; \\ C_t &= [C/A \quad \text{zeros}(mc, ma)]; \\ D_t &= D - C/A \cdot B;\end{aligned}$$

See lp2bp for a derivation of the bandpass version of this transformation.

See Also

bilinear | lp2bp | lp2hp | lp2lp |impinvar

Introduced before R2006a

lp2hp

Transform lowpass analog filters to highpass

Syntax

```
[bt,at] = lp2hp(b,a,Wo)
[At,Bt,Ct,Dt] = lp2hp(A,B,C,D,Wo)
```

Description

lp2hp transforms analog lowpass filter prototypes with a cutoff angular frequency of 1 rad/s into highpass filters with desired cutoff angular frequency. The transformation is one step in the digital filter design process for the `butter`, `cheby1`, `cheby2`, and `ellip` functions.

The `lp2hp` function can perform the transformation on two different linear system representations: transfer function form and state-space form. In both cases, the input system must be an analog filter prototype.

Transfer Function Form (Polynomial)

`[bt,at] = lp2hp(b,a,Wo)` transforms an analog lowpass filter prototype given by polynomial coefficients into a highpass filter with cutoff angular frequency `Wo`. Row vectors `b` and `a` specify the coefficients of the numerator and denominator of the prototype in descending powers of s .

$$\frac{B(s)}{A(s)} = \frac{b(1)s^n + \dots + b(n)s + b(n+1)}{a(1)s^m + \dots + a(m)s + a(m+1)}$$

Scalar `Wo` specifies the cutoff angular frequency in units of radians/second. The frequency transformed filter is returned in row vectors `bt` and `at`.

State-Space Form

`[At,Bt,Ct,Dt] = lp2hp(A,B,C,D,Wo)` converts the continuous-time state-space lowpass filter prototype in matrices `A`, `B`, `C`, `D` below

$$\dot{x} = Ax + Bu$$

$$y = Cx + Du$$

into a highpass filter with cutoff angular frequency ω_0 . The highpass filter is returned in matrices A_t , B_t , C_t , D_t .

Algorithms

lp2hp is a highly accurate state-space formulation of the classic analog filter frequency transformation. If a highpass filter is to have cutoff angular frequency ω_0 , the standard s -domain transformation is

$$s = \frac{\omega_0}{p}$$

The state-space version of this transformation is

$$A_t = \omega_0 \cdot \text{inv}(A);$$

$$B_t = -\omega_0 \cdot (A \setminus B);$$

$$C_t = C/A;$$

$$D_t = D - C/A \cdot B;$$

See lp2bp for a derivation of the bandpass version of this transformation.

See Also

bilinear | lp2bp | lp2bs | lp2lp | impinvar

Introduced before R2006a

lp2lp

Change cutoff frequency for lowpass analog filter

Syntax

```
[bt,at] = lp2lp(b,a,Wo)
[At,Bt,Ct,Dt] = lp2lp(A,B,C,D,Wo)
```

Description

lp2lp transforms an analog lowpass filter prototype with a cutoff angular frequency of 1 rad/s into a lowpass filter with any specified cutoff angular frequency. The transformation is one step in the digital filter design process for the `butter`, `cheby1`, `cheby2`, and `ellip` functions.

The `lp2lp` function can perform the transformation on two different linear system representations: transfer function form and state-space form. In both cases, the input system must be an analog filter prototype.

Transfer Function Form (Polynomial)

`[bt,at] = lp2lp(b,a,Wo)` transforms an analog lowpass filter prototype given by polynomial coefficients into a lowpass filter with cutoff angular frequency `Wo`. Row vectors `b` and `a` specify the coefficients of the numerator and denominator of the prototype in descending powers of s .

$$\frac{B(s)}{A(s)} = \frac{b(1)s^n + \dots + b(n)s + b(n+1)}{a(1)s^m + \dots + a(m)s + a(m+1)}$$

Scalar `Wo` specifies the cutoff angular frequency in units of radians/second. `lp2lp` returns the frequency transformed filter in row vectors `bt` and `at`.

State-Space Form

`[At,Bt,Ct,Dt] = lp2lp(A,B,C,D,Wo)` converts the continuous-time state-space lowpass filter prototype in matrices `A`, `B`, `C`, `D` below

$$\begin{aligned}\dot{x} &= Ax + Bu \\ y &= Cx + Du\end{aligned}$$

into a lowpass filter with cutoff angular frequency ω_0 . `lp2lp` returns the lowpass filter in matrices `At`, `Bt`, `Ct`, `Dt`.

Algorithms

`lp2lp` is a highly accurate state-space formulation of the classic analog filter frequency transformation. If a lowpass filter is to have cutoff angular frequency ω_0 , the standard s -domain transformation is

$$s = p / \omega_0$$

The state-space version of this transformation is

$$\begin{aligned}At &= \omega_0 * A; \\ Bt &= \omega_0 * B; \\ Ct &= C; \\ Dt &= D;\end{aligned}$$

See `lp2bp` for a derivation of the bandpass version of this transformation.

See Also

`bilinear` | `lp2bp` | `lp2bs` | `lp2hp` | `impinvar`

Introduced before R2006a

lpc

Linear prediction filter coefficients

Syntax

```
[a,g] = lpc(x,p)
```

Description

`lpc` determines the coefficients of a forward linear predictor by minimizing the prediction error in the least squares sense. It has applications in filter design and speech coding.

`[a,g] = lpc(x,p)` finds the coefficients of a p th-order linear predictor (FIR filter) that predicts the current value of the real-valued time series x based on past samples.

$$\hat{x}(n) = -a(2)x(n-1) - a(3)x(n-2) - \dots - a(p+1)x(n-p)$$

p is the order of the prediction filter polynomial, $a = [1 \ a(2) \ \dots \ a(p+1)]$. If p is unspecified, `lpc` uses as a default $p = \text{length}(x) - 1$. If x is a matrix containing a separate signal in each column, `lpc` returns a model estimate for each column in the rows of matrix a and a column vector of prediction error variances g . The length of p must be less than or equal to the length of x .

Examples

Estimate a Series Using a Forward Predictor

Estimate a data series using a third-order forward predictor. Compare the estimate to the original signal.

First, create the signal data as the output of an autoregressive process driven by normalized white Gaussian noise. Use the last 4096 samples of the AR process output to avoid startup transients.

```
noise = randn(50000,1);  
x = filter(1,[1 1/2 1/3 1/4],noise);  
x = x(45904:50000);
```

Compute the predictor coefficients, estimated signal, prediction error, and autocorrelation sequence of the prediction error.

```
a = lpc(x,3);  
est_x = filter([0 -a(2:end)],1,x);  
e = x-est_x;  
[acs,lags] = xcorr(e,'coeff');
```

Compare the predicted signal to the original signal.

```
plot(1:97,x(4001:4097),1:97,est_x(4001:4097),'--'), grid  
title 'Original Signal vs. LPC Estimate'  
xlabel 'Sample number', ylabel 'Amplitude'  
legend('Original signal','LPC estimate')
```

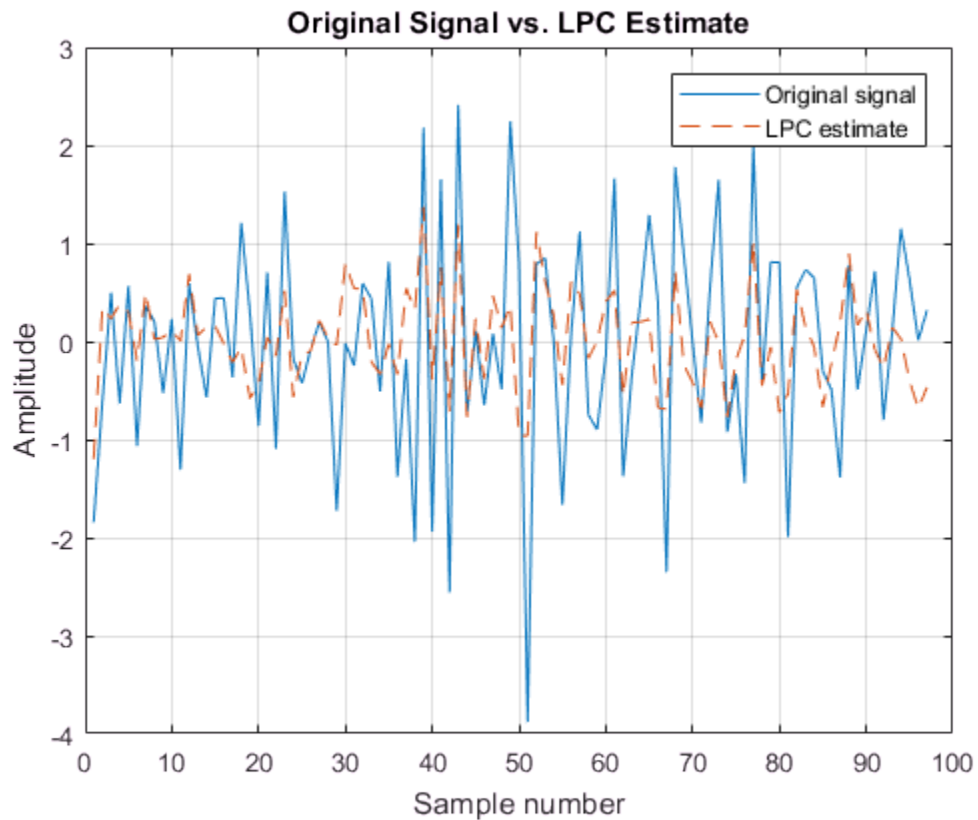

Plot the autocorrelation of the prediction error.

```
plot(lags,acs), grid
title 'Autocorrelation of the Prediction Error'
xlabel 'Lags', ylabel 'Normalized value'
```

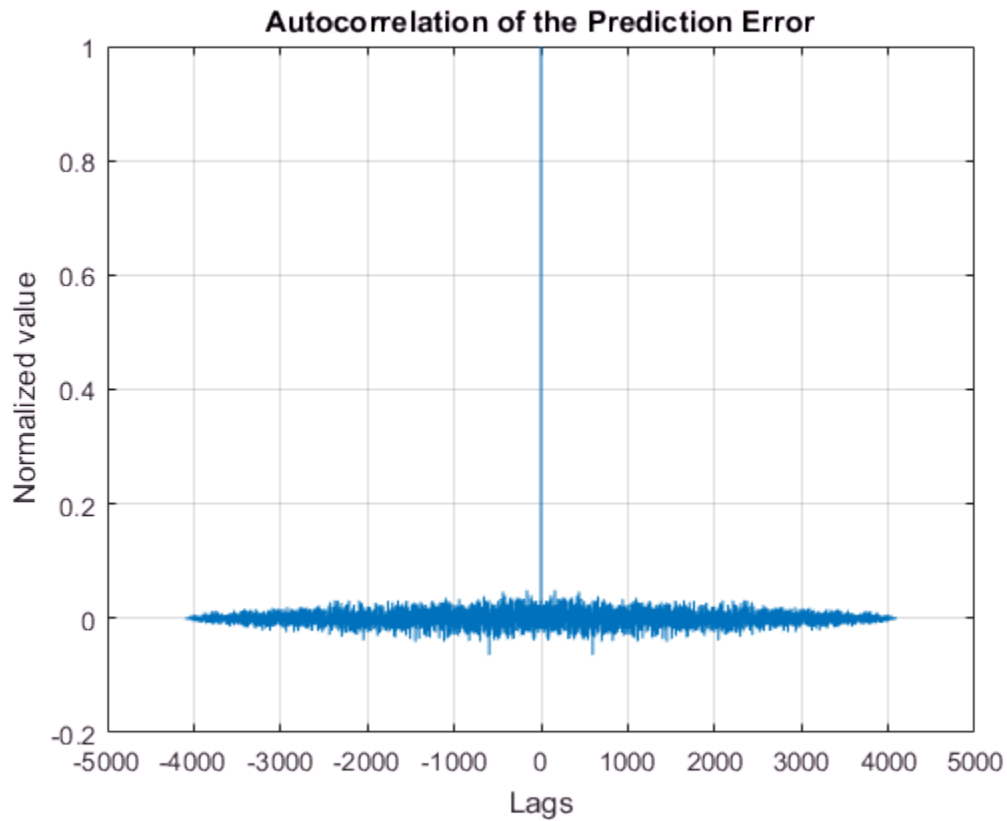

The prediction error is approximately white Gaussian noise, as expected for a third-order AR input process.

Definitions

Prediction Error

The prediction error, $e(n)$, can be viewed as the output of the prediction error filter $A(z)$ shown below, where $H(z)$ is the optimal linear predictor, $x(n)$ is the input signal, and $\hat{x}(n)$ is the predicted signal.

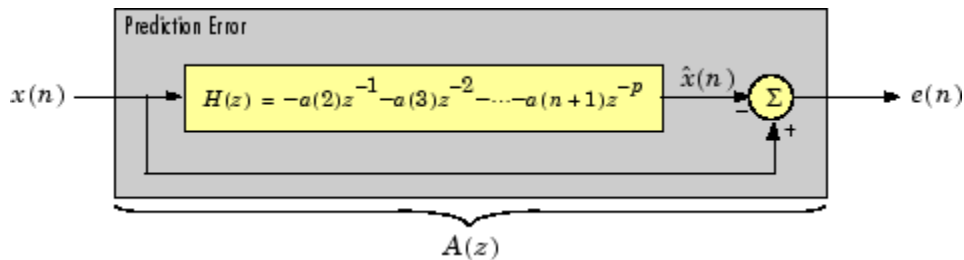

Algorithms

lpc uses the autocorrelation method of autoregressive (AR) modeling to find the filter coefficients. The generated filter might not model the process exactly even if the data sequence is truly an AR process of the correct order. This is because the autocorrelation method implicitly windows the data, that is, it assumes that signal samples beyond the length of x are 0.

lpc computes the least squares solution to

$$Xa = b$$

where

$$X = \begin{bmatrix} x(1) & 0 & \cdots & 0 \\ x(2) & x(1) & \ddots & \vdots \\ \vdots & x(2) & \ddots & 0 \\ x(m) & \vdots & \ddots & x(1) \\ 0 & x(m) & \ddots & x(2) \\ \vdots & \ddots & \ddots & \vdots \\ 0 & \cdots & 0 & x(m) \end{bmatrix}, \quad a = \begin{bmatrix} 1 \\ a(2) \\ \vdots \\ a(p+1) \end{bmatrix}, \quad b = \begin{bmatrix} 1 \\ 0 \\ \vdots \\ 0 \end{bmatrix}$$

and m is the length of x . Solving the least squares problem via the normal equations

$$X^H X a = X^H b$$

leads to the Yule-Walker equations

$$\begin{bmatrix} r(1) & r(2)^* & \cdots & r(p)^* \\ r(2) & r(1) & \ddots & \vdots \\ \vdots & \ddots & \ddots & r(2)^* \\ r(p) & \cdots & r(2) & r(1) \end{bmatrix} \begin{bmatrix} a(2) \\ a(3) \\ \vdots \\ a(p+1) \end{bmatrix} = \begin{bmatrix} -r(2) \\ -r(3) \\ \vdots \\ -r(p+1) \end{bmatrix}$$

where $r = [r(1) \ r(2) \ \dots \ r(p+1)]$ is an autocorrelation estimate for x computed using `xcorr`. The Yule-Walker equations are solved in $O(p^2)$ flops by the Levinson-Durbin algorithm (see `levinson`).

References

- [1] Jackson, L. B. *Digital Filters and Signal Processing*. 2nd Edition. Boston: Kluwer Academic Publishers, 1989, pp.255–257.

See Also

`aryule` | `levinson` | `stmcb` | `prony` | `pyulear`

Introduced before R2006a

lsf2poly

Convert line spectral frequencies to prediction filter coefficients

Syntax

```
a = lsf2poly(lsf)
```

Description

`a = lsf2poly(lsf)` returns a vector, **a**, containing the prediction filter coefficients from the vector, **lsf**, of line spectral frequencies. If **lsf** is a matrix of size $M \times N$ with separate channels of line spectral frequencies in each column, the returned **a** matrix has the resulting prediction filter coefficients as its rows and is of size $N \times (M + 1)$.

Examples

Prediction Coefficients from Line Spectral Frequencies

Given a vector, **lsf**, of line spectral frequencies, determine the equivalent prediction filter coefficients.

```
lsf = [0.7842 1.5605 1.8776 1.8984 2.3593];  
a = lsf2poly(lsf)
```

```
a =
```

```
    1.0000    0.6148    0.9899    0.0001    0.0031   -0.0081
```

References

- [1] Deller, John R., John G. Proakis, and John H. L. Hansen. *Discrete-Time Processing of Speech Signals*. New York: Macmillan, 1993.

[2] Rabiner, Lawrence R., and Ronald W. Schafer. *Digital Processing of Speech Signals*. Englewood Cliffs, NJ: Prentice-Hall, 1978.

See Also

ac2poly | poly2lsf | rc2poly

Introduced before R2006a

mag2db

Convert magnitude to decibels

Syntax

```
ydb = mag2db(y)
```

Description

`ydb = mag2db(y)` expresses in decibels (dB) the magnitude measurements specified in `y`. The relationship between magnitude and decibels is $ydb = 20 \log_{10}(y)$.

Examples

Magnitude Response of a Highpass Filter

Design a 3rd-order highpass Butterworth filter having a normalized 3-dB frequency of 0.5π rad/sample. Compute its frequency response. Express the magnitude response in decibels and plot it.

```
[b,a] = butter(3,0.5,'high');  
[h,w] = freqz(b,a);  
  
dB = mag2db(abs(h));  
  
plot(w/pi,dB)  
xlabel('\omega / \pi')  
ylabel('Magnitude (dB)')  
ylim([-82 5])
```

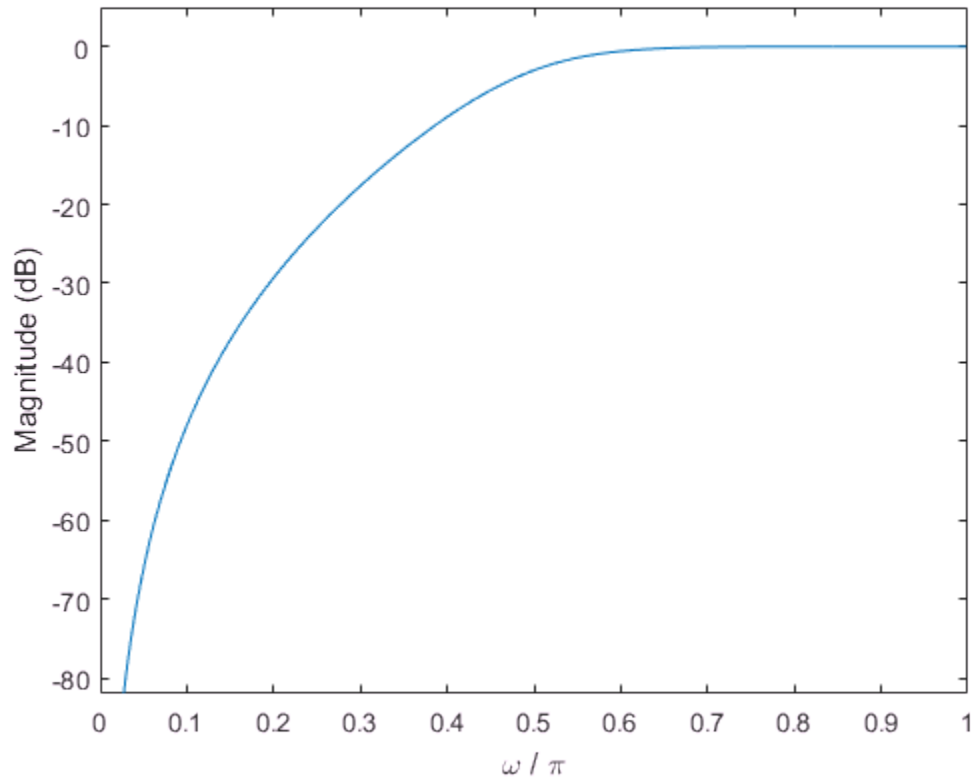

Repeat the computation using `fvtool`.

`fvtool(b,a)`

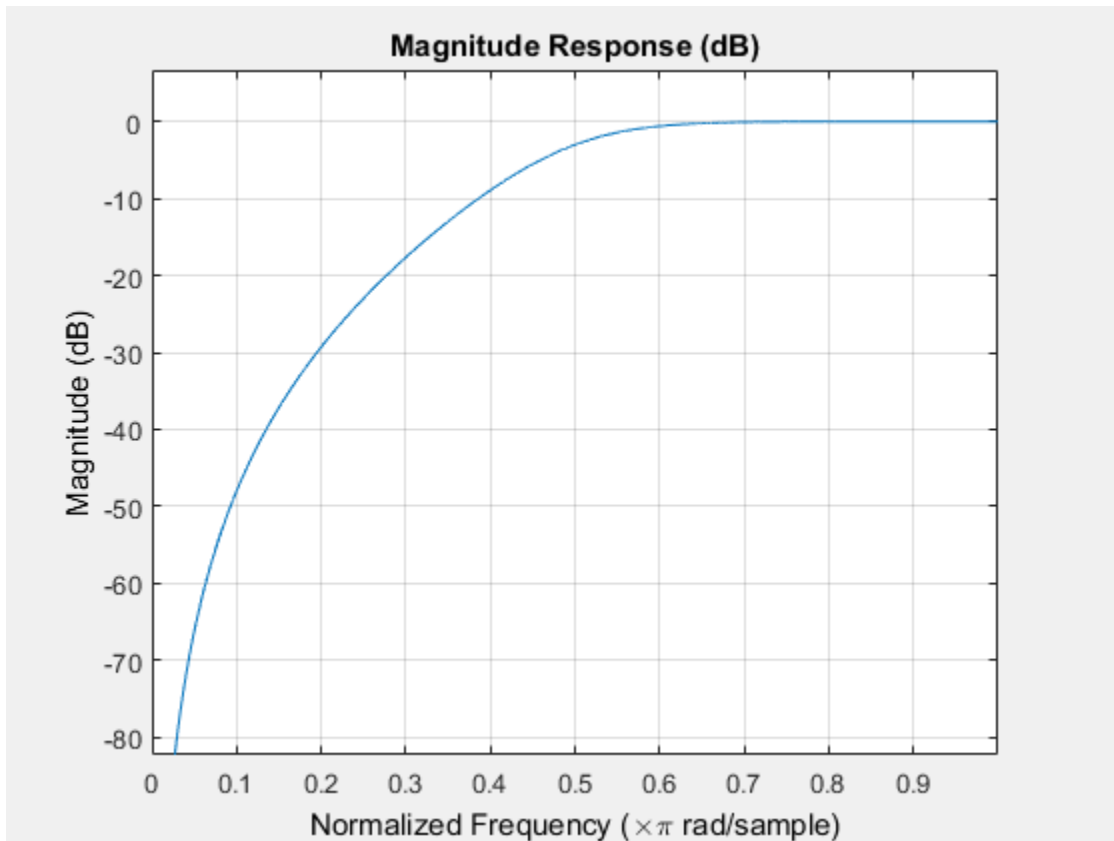

Input Arguments

y — Input array

scalar | vector | matrix | N-D array

Input array, specified as a scalar, vector, matrix, or N-D array. When **y** is nonscalar, `mag2db` is an element-wise operation.

Data Types: `single` | `double`

Output Arguments

ydb — Magnitude measurements in decibels

scalar | vector | matrix | N-D array

Magnitude measurements in decibels, returned as a scalar, vector, matrix, or N-D array of the same size as `y`.

See Also

See Also

`db` | `db2mag` | `db2pow` | `pow2db`

Introduced in R2008a

marcumq

Generalized Marcum Q function

Syntax

Q = marcumq(a, b)
Q = marcumq(a, b, m)

Description

Q = marcumq(a, b) computes the Marcum Q function of a and b, defined by

$$Q(a, b) = \int_b^{\infty} x \exp\left(-\frac{(x^2 + a^2)}{2}\right) I_0(ax) dx$$

where a and b are nonnegative real numbers. In this expression, I_0 is the modified Bessel function of the first kind of zero order.

Q = marcumq(a, b, m) computes the generalized Marcum Q, defined by

$$Q(a, b) = \frac{1}{a^{m-1}} \int_b^{\infty} x^m \exp\left(-\frac{(x^2 + a^2)}{2}\right) I_{m-1}(ax) dx$$

where a and b are nonnegative real numbers, and m is a positive integer. In this expression, I_{m-1} is the modified Bessel function of the first kind of order $m-1$.

If any of the inputs is a scalar, it is expanded to the size of the other inputs.

Algorithms

marcumq uses the algorithm developed in [3]. The paper describes two error criteria: a relative error criterion and an absolute error criterion. marcumq utilizes the absolute error criterion.

References

- [1] Cantrell, P. E., and A. K. Ojha, “Comparison of Generalized Q-Function Algorithms,” *IEEE Transactions on Information Theory*, Vol. IT-33, July, 1987, pp. 591–596.
- [2] Marcum, J. I., “A Statistical Theory of Target Detection by Pulsed Radar: Mathematical Appendix,” RAND Corporation, Santa Monica, CA, Research Memorandum RM-753, July 1, 1948. Reprinted in *IRE Transactions on Information Theory*, Vol. IT-6, April, 1960, pp. 59–267.
- [3] Shnidman, D. A., “The Calculation of the Probability of Detection and the Generalized Marcum Q-Function,” *IEEE Transactions on Information Theory*, Vol. IT-35, March, 1989, pp. 389–400.

See Also

besseli

Introduced in R2008a

maxflat

Generalized digital Butterworth filter design

Syntax

```
[b,a] = maxflat(n,m,Wn)
b = maxflat(n,'sym',Wn)
[b,a,b1,b2] = maxflat(n,m,Wn)
[b,a,b1,b2,sos,g] = maxflat(n,m,Wn)
[...] = maxflat(n,m,Wn,'design_flag')
```

Description

`[b,a] = maxflat(n,m,Wn)` is a lowpass Butterworth filter with numerator and denominator coefficients `b` and `a` of orders `n` and `m`, respectively. `Wn` is the normalized cutoff frequency at which the magnitude response of the filter is equal to $1/\sqrt{2}$ (approximately -3 dB). `Wn` must be between 0 and 1, where 1 corresponds to the Nyquist frequency.

`b = maxflat(n,'sym',Wn)` is a symmetric FIR Butterworth filter. `n` must be even, and `Wn` is restricted to a subinterval of $[0,1]$. The function raises an error if `Wn` is specified outside of this subinterval.

`[b,a,b1,b2] = maxflat(n,m,Wn)` returns two polynomials `b1` and `b2` whose product is equal to the numerator polynomial `b` (that is, `b = conv(b1,b2)`). `b1` contains all the zeros at $z = -1$, and `b2` contains all the other zeros.

`[b,a,b1,b2,sos,g] = maxflat(n,m,Wn)` returns the second-order sections representation of the filter as the filter matrix `sos` and the gain `g`.

`[...] = maxflat(n,m,Wn,'design_flag')` enables you to monitor the filter design, where `'design_flag'` is

- `'trace'` for a textual display of the design table used in the design
- `'plots'` for plots of the filter's magnitude, group delay, and zeros and poles

- 'both' for both the textual display and plots

Examples

Generalized Butterworth Filter

Design a generalized Butterworth filter with normalized cutoff frequency 0.2π rad/s. Specify a numerator order of 10 and a denominator order of 2. Visualize the frequency response of the filter.

```
n = 10;  
m = 2;  
Wn = 0.2;  
  
[b,a] = maxflat(n,m,Wn);  
fvtool(b,a)
```

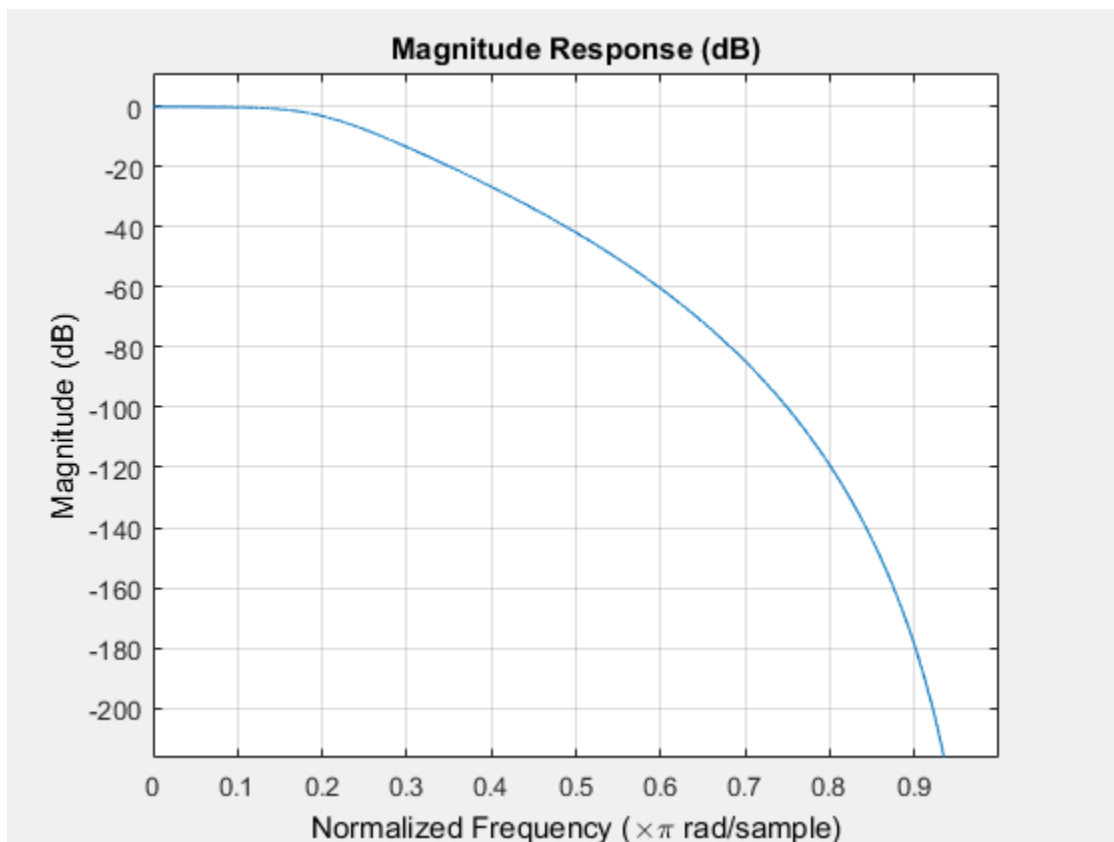

Algorithms

The method consists of the use of formulae, polynomial root finding, and a transformation of polynomial roots.

References

- [1] Selesnick, Ivan W., and C. Sidney Burrus. "Generalized Digital Butterworth Filter Design." *IEEE Transactions on Signal Processing*. Vol.46, Number6, 1998, pp.1688–1694.

Extended Capabilities

C/C++ Code Generation

Generate C and C++ code using MATLAB® Coder™.

Usage notes and limitations:

All inputs must be constant. Expressions or variables are allowed if their values do not change.

See Also

`butter` | `filter` | `freqz`

Introduced before R2006a

meanfreq

Mean frequency

Syntax

```
freq = meanfreq(x)
freq = meanfreq(x, fs)

freq = meanfreq(pxx, f)
freq = meanfreq(sxx, f, rbw)

freq = meanfreq( ____, freqrange)

[ freq, power ] = meanfreq( ____, )
meanfreq( ____, )
```

Description

`freq = meanfreq(x)` estimates the mean normalized frequency, `freq`, of the power spectrum of a time-domain signal, `x`.

`freq = meanfreq(x, fs)` estimates the mean frequency in terms of the sample rate, `fs`.

`freq = meanfreq(pxx, f)` returns the mean frequency of a power spectral density (PSD) estimate, `pxx`. The frequencies, `f`, correspond to the estimates in `pxx`.

`freq = meanfreq(sxx, f, rbw)` returns the mean frequency of a power spectrum estimate, `sxx`, with resolution bandwidth `rbw`.

`freq = meanfreq(____, freqrange)` specifies the frequency interval over which to compute the mean frequency, using any of the input arguments from previous syntaxes. The default value for `freqrange` is the entire bandwidth of the input signal.

`[freq, power] = meanfreq(____,)` also returns the band power, `power`, of the spectrum. If you specify `freqrange`, then `power` contains the band power within `freqrange`.

`meanfreq(___)` with no output arguments plots the PSD or power spectrum and annotates the mean frequency.

Examples

Mean Frequency of Chirps

Generate 1024 samples of a chirp sampled at 1024 kHz. The chirp has an initial frequency of 50 kHz and reaches 100 kHz at the end of the sampling. Add white Gaussian noise such that the signal-to-noise ratio is 40 dB. Reset the random number generator for reproducible results.

```
nSamp = 1024;
Fs = 1024e3;
SNR = 40;
rng default

t = (0:nSamp-1)'/Fs;

x = chirp(t,50e3,nSamp/Fs,100e3);
x = x+randn(size(x))*std(x)/db2mag(SNR);
```

Estimate the mean frequency of the chirp. Plot the power spectral density (PSD) and annotate the mean frequency.

```
meanfreq(x,Fs)

ans = 7.5032e+04
```

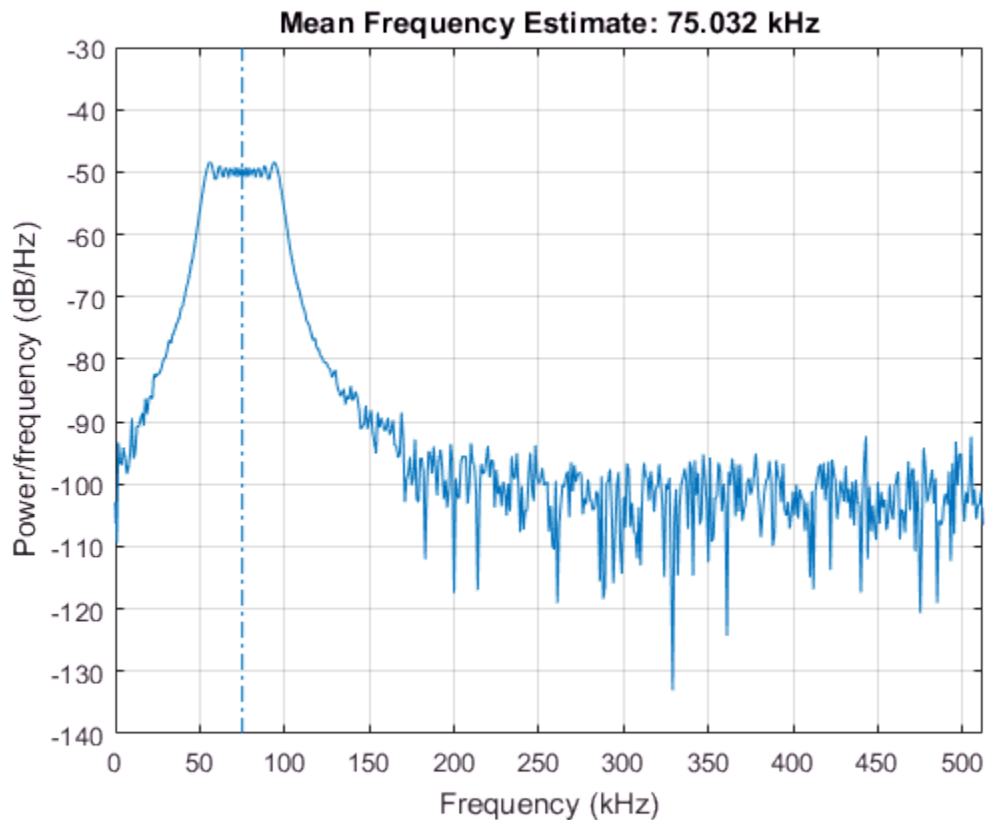

Generate another chirp. Specify an initial frequency of 200 kHz, a final frequency of 300 kHz, and an amplitude that is twice that of the first signal. Add white Gaussian noise.

```
x2 = 2*chirp(t,200e3,nSamp/Fs,300e3);
x2 = x2+randn(size(x2))*std(x2)/db2mag(SNR);
```

Concatenate the chirps to produce a two-channel signal. Estimate the mean frequency of each channel.

```
y = meanfreq([x x2],Fs)
```

```
y =
```

```
1.0e+05 *
```

```
0.7503    2.4999
```

Plot the PSDs of the two channels and annotate their mean frequencies.

```
meanfreq([x x2],Fs);
```

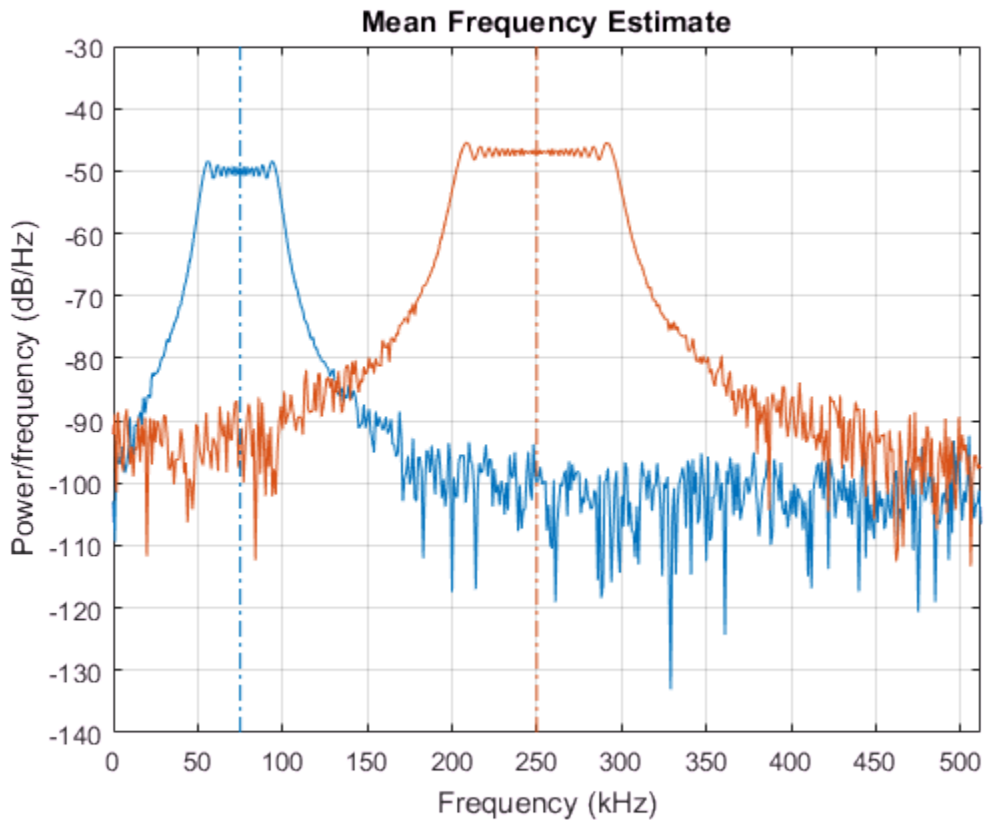

Add the two channels to form a new signal. Plot the PSD and annotate the mean frequency.

```
meanfreq(x+x2,Fs)
```

```
ans = 2.1496e+05
```

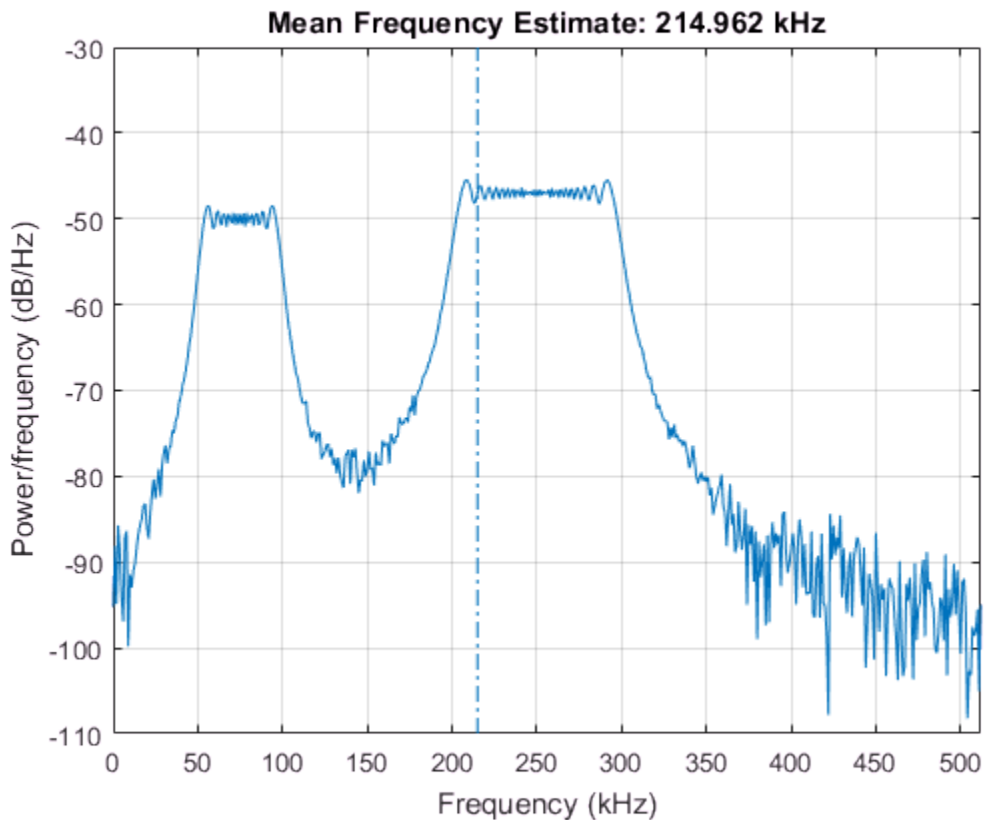
Mean Frequency of Sinusoids

Generate 1024 samples of a 100.123 kHz sinusoid sampled at 1024 kHz. Add white Gaussian noise such that the signal-to-noise ratio is 40 dB. Reset the random number generator for reproducible results.

```
nSamp = 1024;  
Fs = 1024e3;  
SNR = 40;  
rng default
```

```
t = (0:nSamp-1)'/Fs;
```

```
x = sin(2*pi*t*100.123e3);
x = x + randn(size(x))*std(x)/db2mag(SNR);
```

Use the `periodogram` function to compute the power spectral density (PSD) of the signal. Specify a Kaiser window with the same length as the signal and a shape factor of 38. Estimate the mean frequency of the signal and annotate it on a plot of the PSD.

```
[Pxx,f] = periodogram(x,kaiser(nSamp,38),[],Fs);
meanfreq(Pxx,f);
```

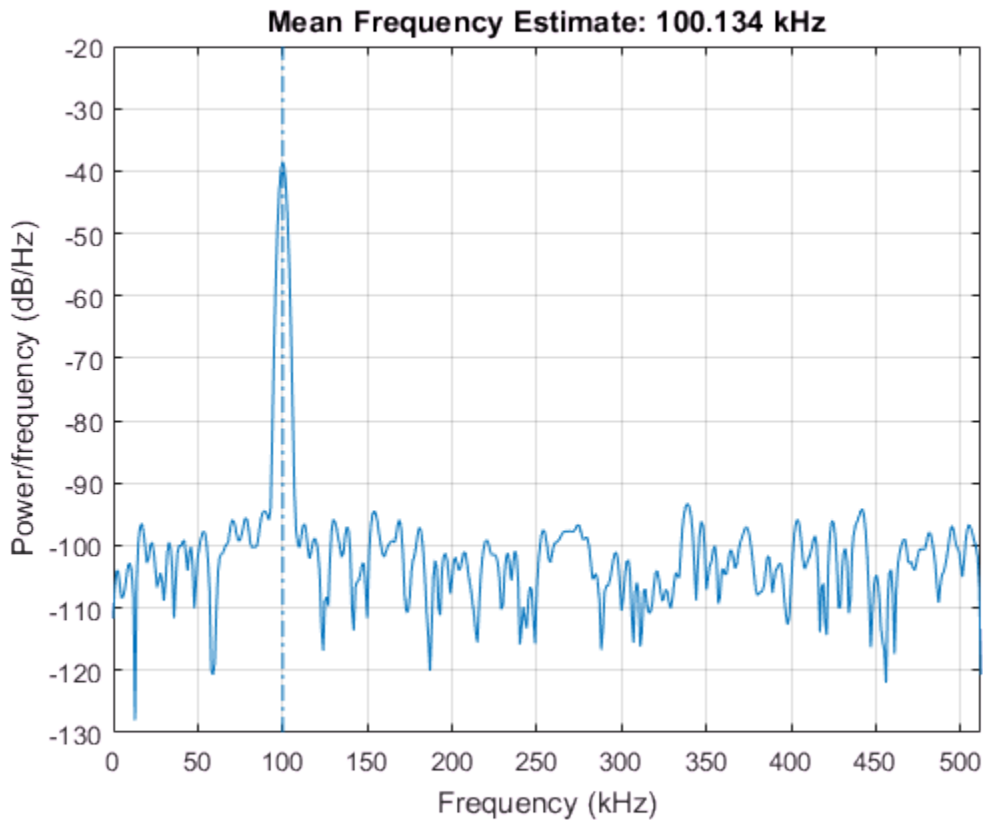

Generate another sinusoid, this one with a frequency of 257.321 kHz and an amplitude that is twice that of the first sinusoid. Add white noise.

```
x2 = 2*sin(2*pi*t*257.321e3);  
x2 = x2 + randn(size(x2))*std(x2)/db2mag(SNR);
```

Concatenate the sinusoids to produce a two-channel signal. Estimate the PSD of each channel and use the result to determine the mean frequency.

```
[Pyy,f] = periodogram([x x2],kaiser(nSamp,38),[],Fs);
```

```
y = meanfreq(Pyy,f)
```

```
y =
```

```
1.0e+05 *  
1.0013    2.5732
```

Annotate the mean frequencies of the two channels on a plot of the PSDs.

```
meanfreq(Pyy,f);
```

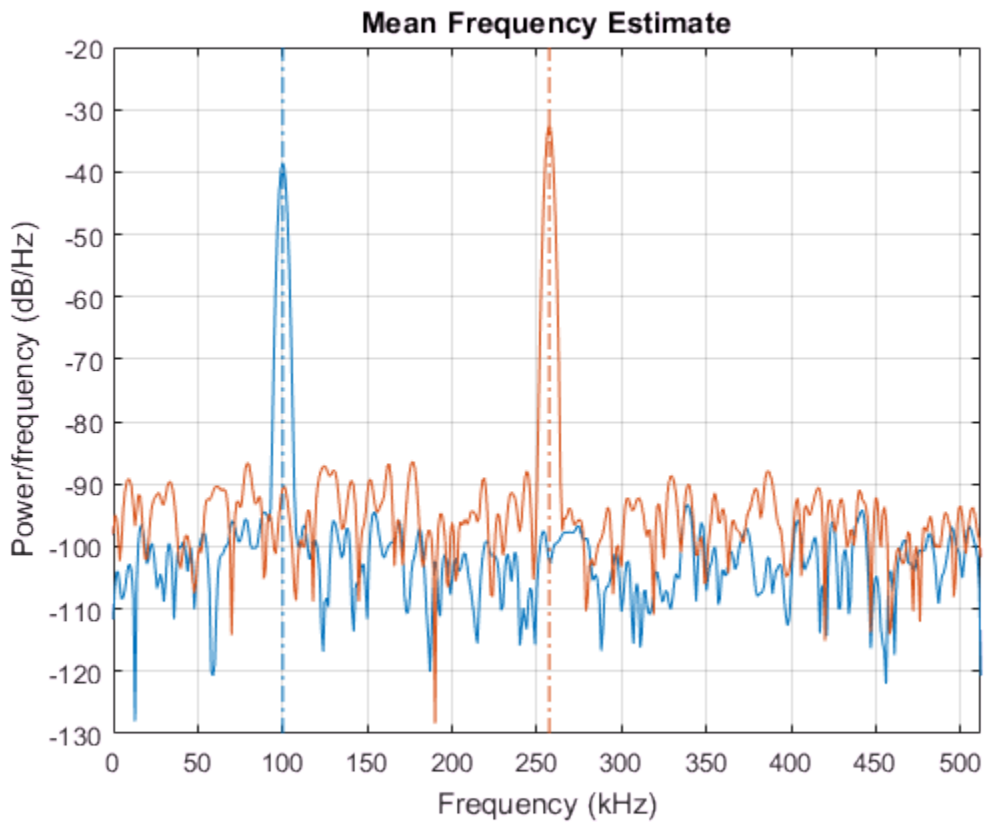

Add the two channels to form a new signal. Estimate the PSD and annotate the mean frequency.

```
[Pzz,f] = periodogram(x+x2,kaiser(nSamp,38),[],Fs);
```

```
meanfreq(Pzz,f);
```

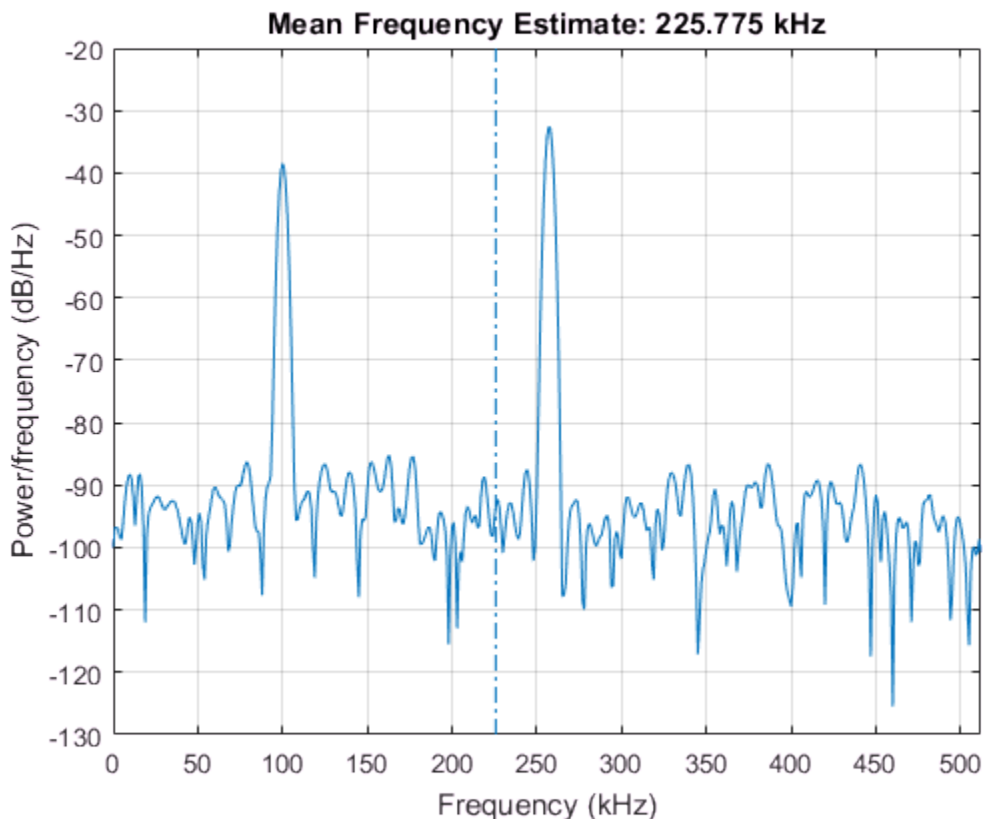

Mean Frequency of Bandlimited Signals

Generate a signal whose PSD resembles the frequency response of an 88th-order bandpass FIR filter with normalized cutoff frequencies 0.25π rad/sample and 0.45π rad/sample.

```
d = fir1(88,[0.25 0.45]);
```

Compute the mean frequency of the signal between 0.3π rad/sample and 0.6π rad/sample. Plot the PSD and annotate the mean frequency and measurement interval.

```
meanfreq(d,[],[0.3 0.6]*pi);
```

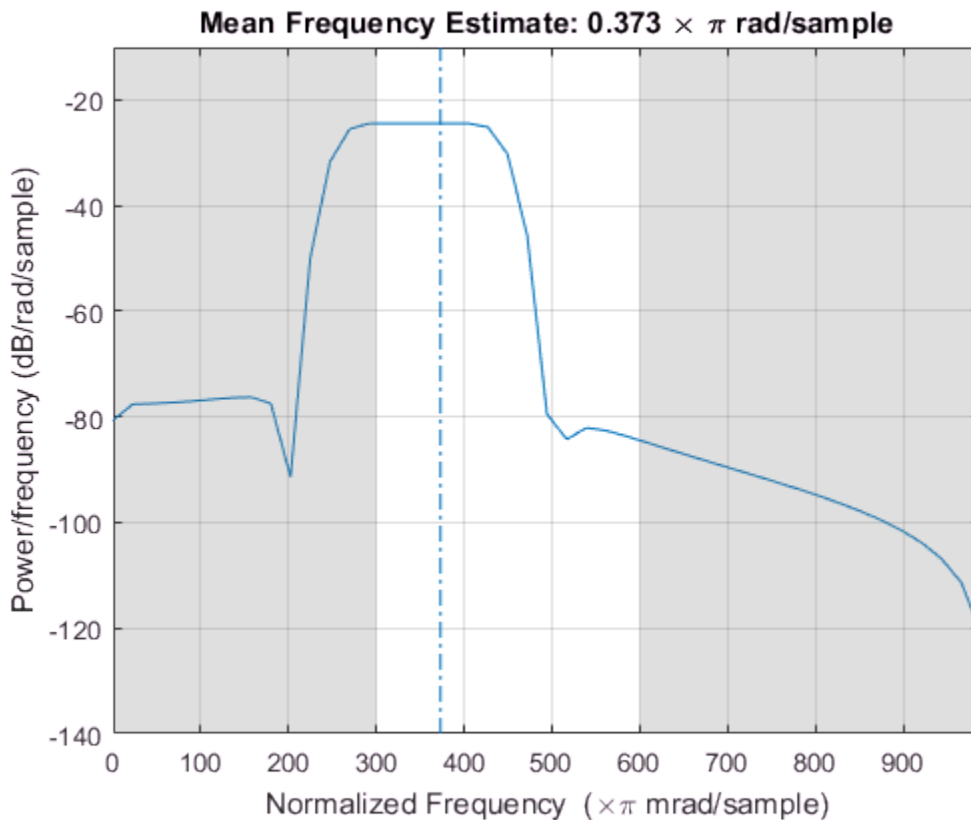

Output the mean frequency and the band power of the measurement interval. Specifying a sample rate of 2π is equivalent to leaving the rate unset.

```
[mnf,power] = meanfreq(d,2*pi,[0.3 0.6]*pi);
fprintf('Mean = %.3f*pi, power = %.1f%% of total \n', ...
        mnf/pi,power/bandpower(d)*100)
Mean = 0.373*pi, power = 75.6% of total
```

Add a second channel with normalized cutoff frequencies 0.5π rad/sample and 0.8π rad/sample and an amplitude that is one-tenth that of the first channel.

```
d = [d;fir1(88,[0.5 0.8])/10]';
```

Compute the mean frequency of the signal between 0.3π rad/sample and 0.9π rad/sample. Plot the PSD and annotate the mean frequency of each channel and the measurement interval.

```
meanfreq(d,[],[0.3 0.9]*pi);
```

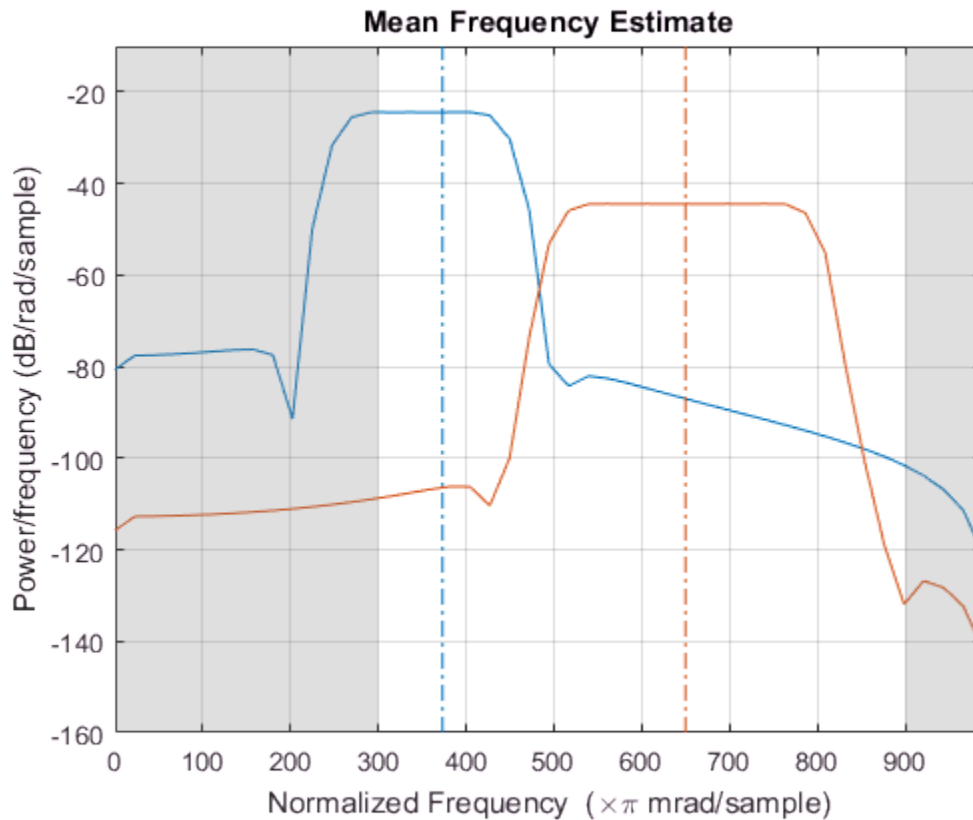

Output the mean frequency of each channel. Divide by π .

```
mnf = meanfreq(d,[],[0.3 0.9]*pi)/pi
```

```
mnf =
```

```
0.3730    0.6500
```

Input Arguments

x — Input signal

vector | matrix

Input signal, specified as a vector or matrix. If **x** is a vector, it is treated as a single channel. If **x** is a matrix, then `meanfreq` computes the mean frequency of each column of **x** independently. **x** must be finite-valued.

Example: `cos(pi/4*(0:159))+randn(1,160)` is a single-channel row-vector signal.

Example: `cos(pi./[4;2]*(0:159))'+randn(160,2)` is a two-channel signal.

Data Types: `single` | `double`

fs — Sample rate

positive real scalar

Sample rate, specified as a positive real scalar. The sample rate is the number of samples per unit time. If the time is measured in seconds, then the sample rate is in hertz.

Data Types: `single` | `double`

pxx — Power spectral density

vector | matrix

Power spectral density (PSD), specified as a vector or matrix. If **pxx** is a matrix, then `meanfreq` computes the mean frequency of each column of **pxx** independently.

Example: `periodogram(cos(pi./[4;2]*(0:159))'+randn(160,2))` is the periodogram PSD estimate of a two-channel sinusoid embedded in white Gaussian noise.

Data Types: `single` | `double`

f — Frequencies

vector

Frequencies, specified as a vector.

Data Types: `single` | `double`

sxx — Power spectrum estimate

vector | matrix

Power spectrum estimate, specified as a vector or matrix. If **sxx** is a matrix, then **meanfreq** computes the mean frequency of each column of **sxx** independently.

Example: `periodogram(cos(pi./[4;2]*(0:159))'+randn(160,2),'power')` is the periodogram power spectrum estimate of a two-channel sinusoid embedded in white Gaussian noise.

Data Types: single | double

rbw — Resolution bandwidth

positive scalar

Resolution bandwidth, specified as a positive scalar. The resolution bandwidth is the product of two values: the frequency resolution of the discrete Fourier transform and the equivalent noise bandwidth of the window used to compute the PSD.

Data Types: single | double

freqrange — Frequency range

two-element vector

Frequency range, specified as a two-element vector of real values. If you do not specify **freqrange**, then **meanfreq** uses the entire bandwidth of the input signal.

Data Types: single | double

Output Arguments

freq — Mean frequency

scalar | vector

Mean frequency, specified as a scalar or vector.

- If you specify a sample rate, then **freq** has the same units as **fs**.
- If you do not specify a sample rate, then **freq** has units of rad/sample.

power — Band power

scalar | vector

Band power, returned as a scalar or vector.

See Also

See Also

`findpeaks` | `medfreq` | `periodogram` | `plomb` | `pwelch`

Introduced in R2015a

medfilt1

1-D median filtering

Syntax

```
y = medfilt1(x)
y = medfilt1(x,n)

y = medfilt1(x,n,blksize,dim)
y = medfilt1(x,n,[],dim)

y = medfilt1( ___,nanflag,padding)
```

Description

`y = medfilt1(x)` applies a third-order one-dimensional median filter to the input vector, `x`. The function considers the signal to be 0 beyond the endpoints. The output, `y`, has the same length as `x`.

`y = medfilt1(x,n)` applies an `n`th-order one-dimensional median filter to `x`.

`y = medfilt1(x,n,blksize,dim)` or `y = medfilt1(x,n,[],dim)` specifies the dimension, `dim`, along which the filter operates. `blksize` is required for backward compatibility and is ignored.

`y = medfilt1(___,nanflag,padding)` specifies how NaN values are treated over each segment, using any input arguments from previous syntaxes. This syntax also specifies `padding`, the type of filtering performed at the signal edges.

`nanflag` and `padding` can appear anywhere after `x` in the function call.

Examples

Noise Suppression by Median Filtering

Generate a sinusoidal signal sampled for 1 second at 100 Hz. Add a higher-frequency sinusoid to simulate noise.

```
fs = 100;  
t = 0:1/fs:1;  
x = sin(2*pi*t*3)+0.25*sin(2*pi*t*40);
```

Use a 10th-order median filter to smooth the signal. Plot the result.

```
y = medfilt1(x,10);  
  
plot(t,x,t,y)  
legend('Original','Filtered')  
legend('boxoff')
```

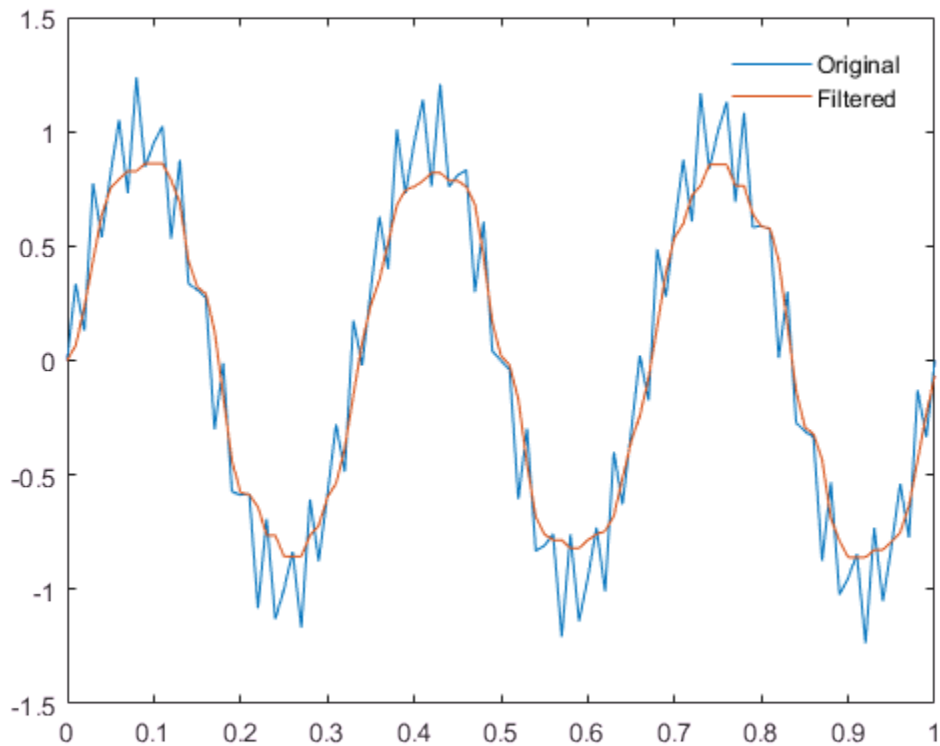

Multichannel Signal with Spikes and Missing Samples

Generate a two-channel signal consisting of sinusoids of different frequencies. Place spikes in random places. Use NaNs to add missing samples at random. Reset the random number generator for reproducible results. Plot the signal.

```
rng('default')

n = 59;
x = sin(pi./[15 10]'*(1:n)+pi/3)';

spk = randi(2*n,9,1);
x(spk) = x(spk)*2;
x(randi(2*n,6,1)) = NaN;

plot(x)
```

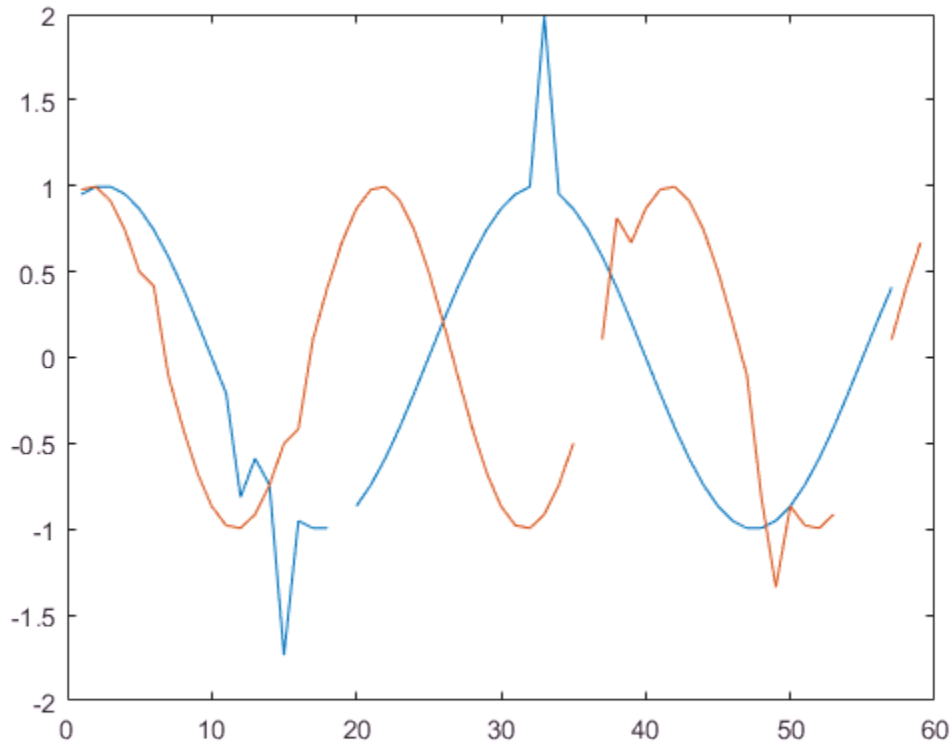

Filter the signal using `medfilt1` with the default settings. Plot the filtered signal. By default, the filter assigns NaN to the median of any segment with missing samples.

```
y = medfilt1(x);  
plot(y)
```

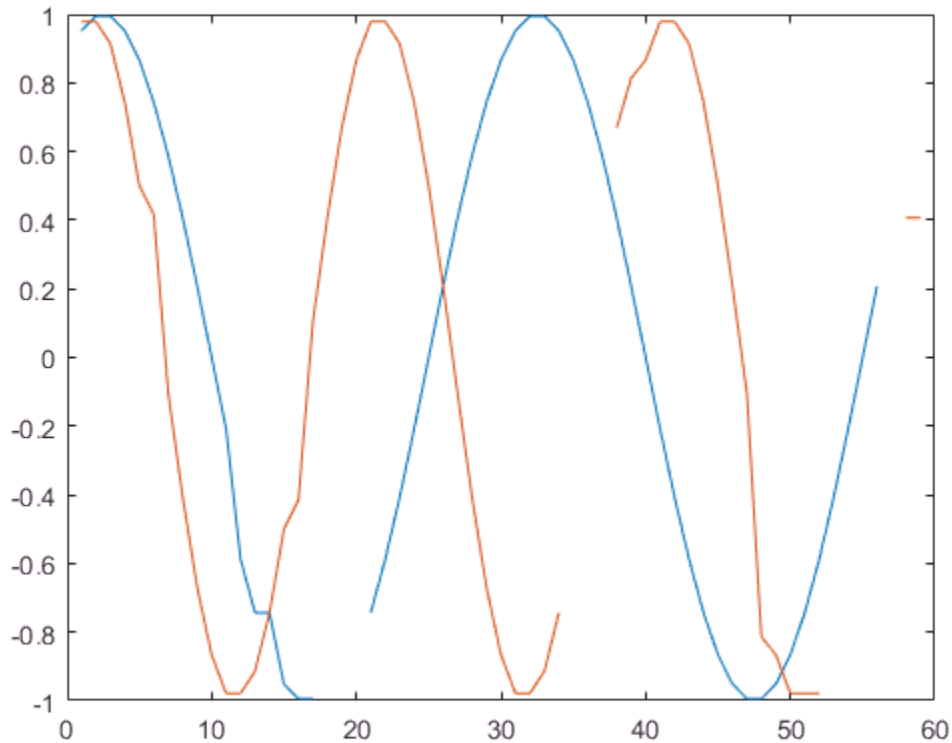

Transpose the original signal. Filter it again, specifying that the function work along the rows. Exclude the missing samples when computing the medians. If you leave the second argument empty, then `medfilt1` uses the default filter order of 3.

```
y = medfilt1(x',[],[],2,'omitnan');  
plot(y')
```

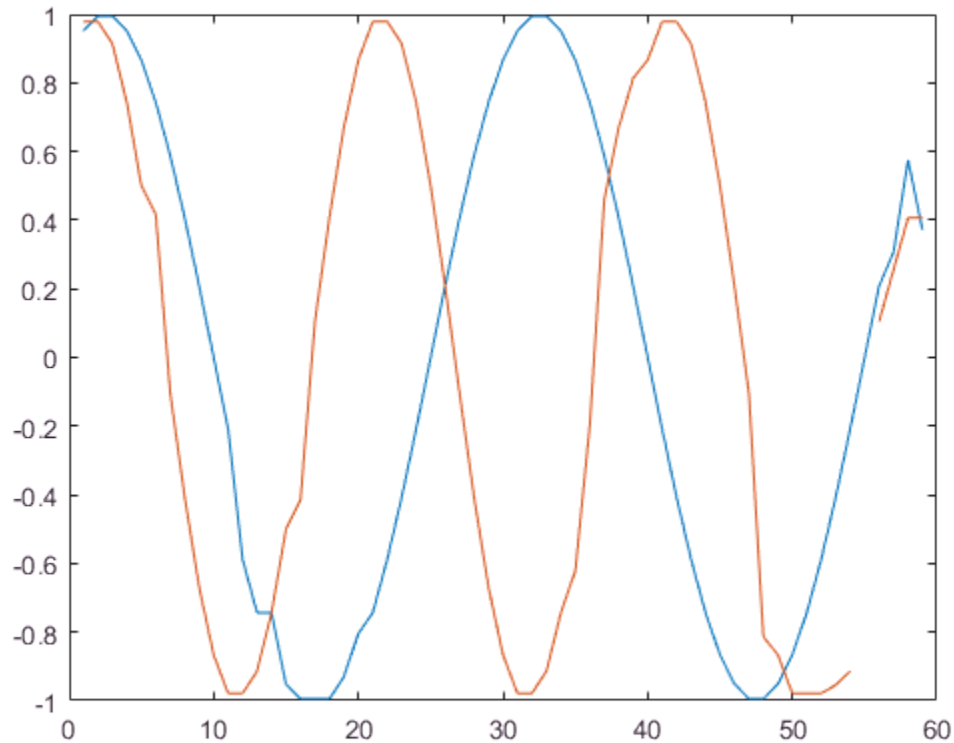

The function cannot assign a value to the segment that contains only NaNs. Increase the segment length to fix this issue. The change also removes the outlier more thoroughly.

```
y = medfilt1(x,4,'omitnan');  
plot(y)
```

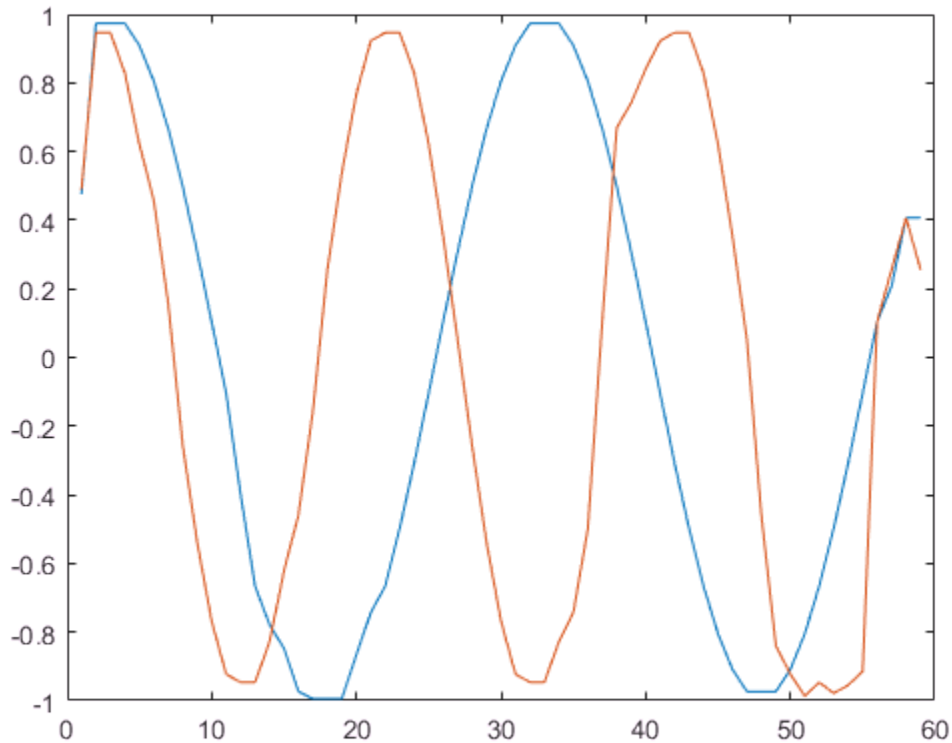
The default zero padding results in the function's underestimating the signal values at the edges. Lessen this effect by using decreasing windows to compute the medians at the ends.

```
y = medfilt1(x,4,'omitnan','truncate');  
plot(y)
```

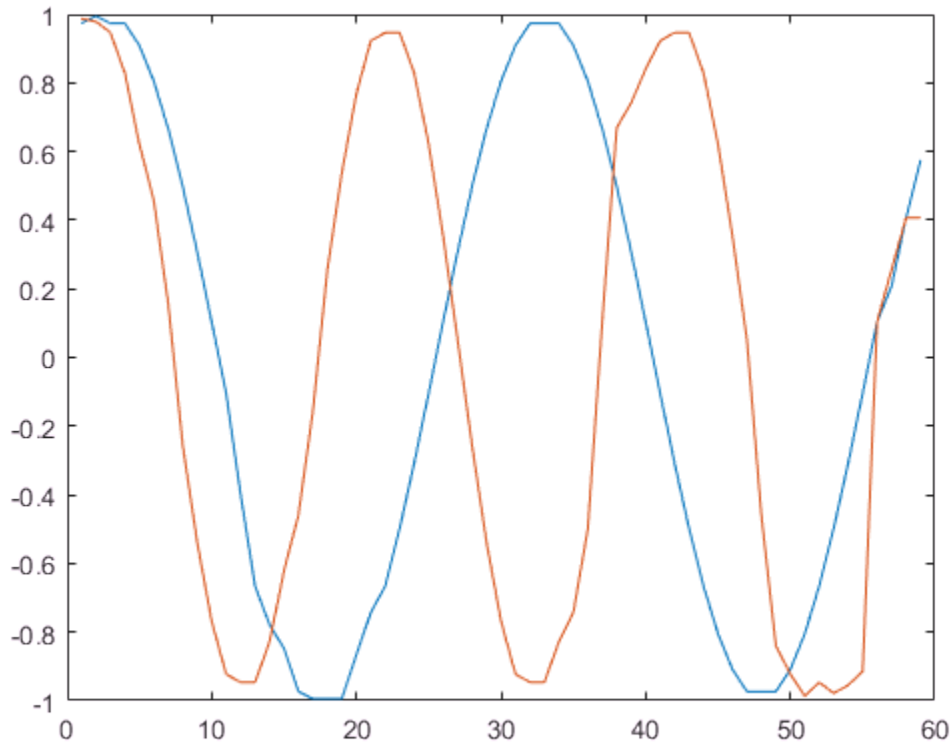

Input Arguments

x — Input signal

vector | matrix | N-D array

Input signal, specified as a real-valued vector, matrix, or N-D array.

Data Types: single | double

n — Filter order

3 (default) | positive integer scalar

Order of the one-dimensional median filter, specified as a positive integer scalar.

- When n is odd, $y(k)$ is the median of $x(k - (n-1)/2 : k + (n-1)/2)$.
- When n is even, $y(k)$ is the median of $x(k - n/2 : k + (n/2) - 1)$. In this case, `medfilt1` sorts the numbers and takes the average of the two middle elements of the sorted list.

Example: If $n = 11$, then $y(k)$ is the median of $x(k-5:k+5)$.

Example: If $n = 12$, then $y(k)$ is the median of $x(k-6:k+5)$.

Data Types: double

dim — Dimension to filter along

positive integer scalar

Dimension to filter along, specified as a positive integer scalar. By default, `medfilt1` operates along the first nonsingleton dimension of x . In particular, if x is a matrix, the function filters its columns so that $y(:,i) = \text{medfilt1}(x(:,i),n)$.

Data Types: double

nanflag — NaN condition

'includenan' (default) | 'omitnan'

NaN condition, specified as 'includenan' or 'omitnan'.

- 'includenan' — Returns the filtered signal so that the median of any segment containing NaNs is also NaN.
- 'omitnan' — Returns the filtered signal so that the median of any segment containing NaNs is the median of the non-NaN values. If all elements of a segment are NaNs, the result is NaN.

Data Types: char

padding — Endpoint filtering

'zeropad' (default) | 'truncate'

Endpoint filtering, specified as 'zeropad' or 'truncate'.

- 'zeropad' — Considers the signal to be zero beyond the endpoints.
- 'truncate' — Computes medians of smaller segments as it reaches the signal edges.

Data Types: char

Output Arguments

y — Filtered signal

vector | matrix | N-D array

Filtered signal, returned as a real-valued vector, matrix, or N-D array. **y** is the same size as **x**

Data Types: double

Tips

If you have a license for Image Processing Toolbox™ software, you can use the `medfilt2` function to perform two-dimensional median filtering.

References

[1] Pratt, William K. *Digital Image Processing*. 4th Ed. Hoboken, NJ: John Wiley & Sons, 2007.

See Also

See Also

`filter` | `hampel` | `median` | `movmedian` | `sgolayfilt`

Introduced before R2006a

medfreq

Median frequency

Syntax

```
freq = medfreq(x)
freq = medfreq(x, fs)

freq = medfreq(pxx, f)
freq = medfreq(sxx, f, rbw)

freq = medfreq( ____, freqrange)

[ freq, power ] = medfreq( ____)

medfreq( ____)
```

Description

`freq = medfreq(x)` estimates the median normalized frequency, `freq`, of the power spectrum of a time-domain signal, `x`.

`freq = medfreq(x, fs)` estimates the median frequency in terms of the sample rate, `fs`.

`freq = medfreq(pxx, f)` returns the median frequency of a power spectral density (PSD) estimate, `pxx`. The frequencies, `f`, correspond to the estimates in `pxx`.

`freq = medfreq(sxx, f, rbw)` returns the median frequency of a power spectrum estimate, `sxx`, with resolution bandwidth `rbw`.

`freq = medfreq(____, freqrange)` specifies the frequency interval over which to compute the median frequency, using any of the input arguments from previous syntaxes. The default value for `freqrange` is the entire bandwidth of the input signal.

`[freq, power] = medfreq(____)` also returns the band power, `power`, of the spectrum. If you specify `freqrange`, then `power` contains the band power within `freqrange`.

`medfreq(___)` with no output arguments plots the PSD or power spectrum and annotates the median frequency.

Examples

Median Frequency of Chirps

Generate 1024 samples of a chirp sampled at 1024 kHz. Specify the chirp so that it has an initial frequency of 50 kHz and reaches 100 kHz at the end of the sampling. Add white Gaussian noise such that the signal-to-noise ratio is 40 dB. Reset the random number generator for reproducible results.

```
nSamp = 1024;  
Fs = 1024e3;  
SNR = 40;  
rng default  
  
t = (0:nSamp-1)'/Fs;  
  
x = chirp(t,50e3,nSamp/Fs,100e3);  
x = x+randn(size(x))*std(x)/db2mag(SNR);
```

Estimate the median frequency of the chirp. Plot the power spectral density (PSD) and annotate the median frequency.

```
medfreq(x,Fs)  
  
ans = 7.4998e+04
```

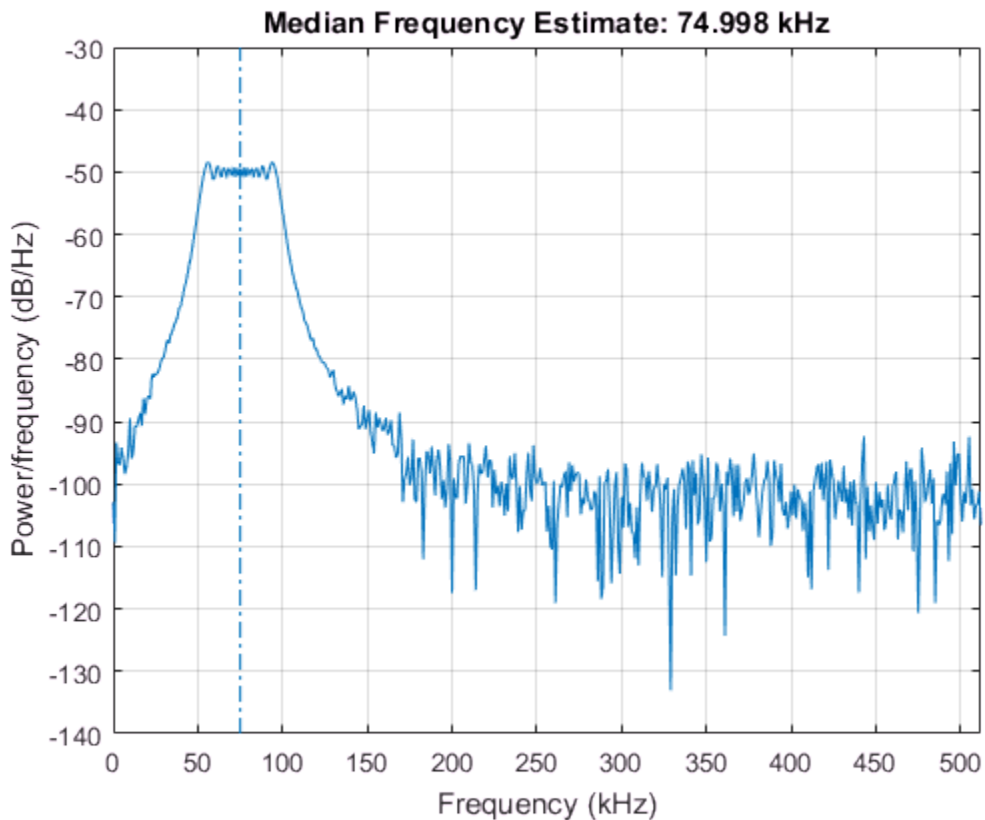

Generate another chirp. Specify an initial frequency of 200 kHz, a final frequency of 300 kHz, and an amplitude that is twice that of the first signal. Add white Gaussian noise.

```
x2 = 2*chirp(t,200e3,nSamp/Fs,300e3);
x2 = x2+randn(size(x2))*std(x2)/db2mag(SNR);
```

Concatenate the chirps to produce a two-channel signal. Estimate the median frequency of each channel.

```
y = medfreq([x x2],Fs)
```

```
y =
```

```
1.0e+05 *
```

0.7500 2.4999

Plot the PSDs of the two channels and annotate their median frequencies.

```
medfreq([x x2],Fs);
```

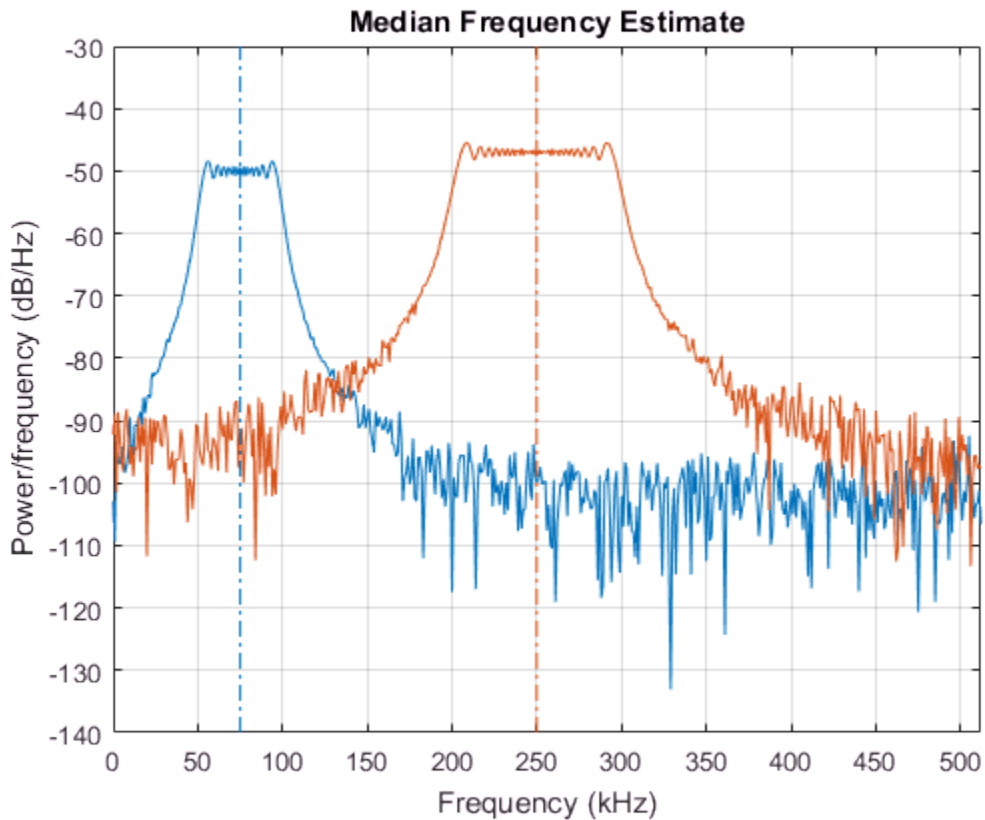

Add the two channels to form a new signal. Plot the PSD and annotate the median frequency.

```
medfreq(x+x2,Fs)
```

```
ans = 2.3756e+05
```

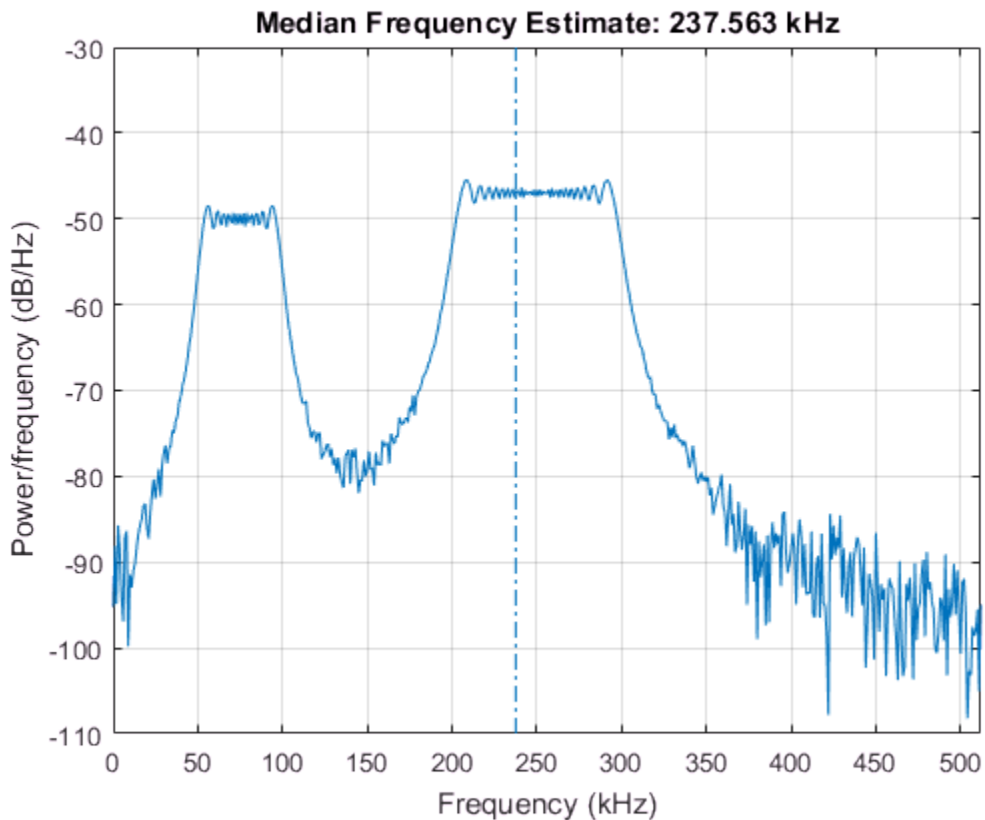
Median Frequency of Sinusoids

Generate 1024 samples of a 100.123 kHz sinusoid sampled at 1024 kHz. Add white Gaussian noise such that the signal-to-noise ratio is 40 dB. Reset the random number generator for reproducible results.

```
nSamp = 1024;  
Fs = 1024e3;  
SNR = 40;  
rng default  
  
t = (0:nSamp-1)'/Fs;
```

```
x = sin(2*pi*t*100.123e3);  
x = x + randn(size(x))*std(x)/db2mag(SNR);
```

Use the `periodogram` function to compute the power spectral density (PSD) of the signal. Specify a Kaiser window with the same length as the signal and a shape factor of 38. Estimate the median frequency of the signal and annotate it on a plot of the PSD.

```
[Pxx,f] = periodogram(x,kaiser(nSamp,38),[],Fs);  
medfreq(Pxx,f);
```

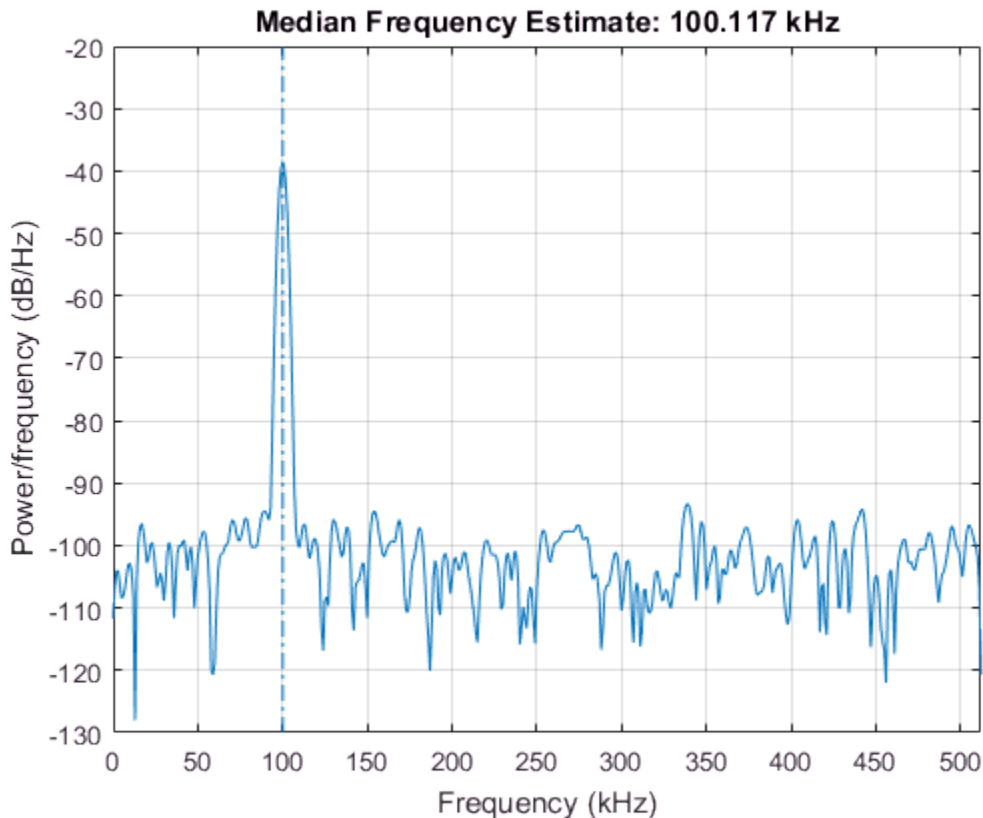

Generate another sinusoid, this one with a frequency of 257.321 kHz and an amplitude that is twice that of the first sinusoid. Add white noise.

```
x2 = 2*sin(2*pi*t*257.321e3);  
x2 = x2 + randn(size(x2))*std(x2)/db2mag(SNR);
```

Concatenate the sinusoids to produce a two-channel signal. Estimate the PSD of each channel and use the result to determine the median frequency.

```
[Pyy,f] = periodogram([x x2],kaiser(nSamp,38),[],Fs);
```

```
y = medfreq(Pyy,f)
```

```
y =
```

```
1.0e+05 *  
1.0012    2.5731
```

Annotate the median frequencies of the two channels on a plot of the PSDs.

```
medfreq(Pyy,f);
```

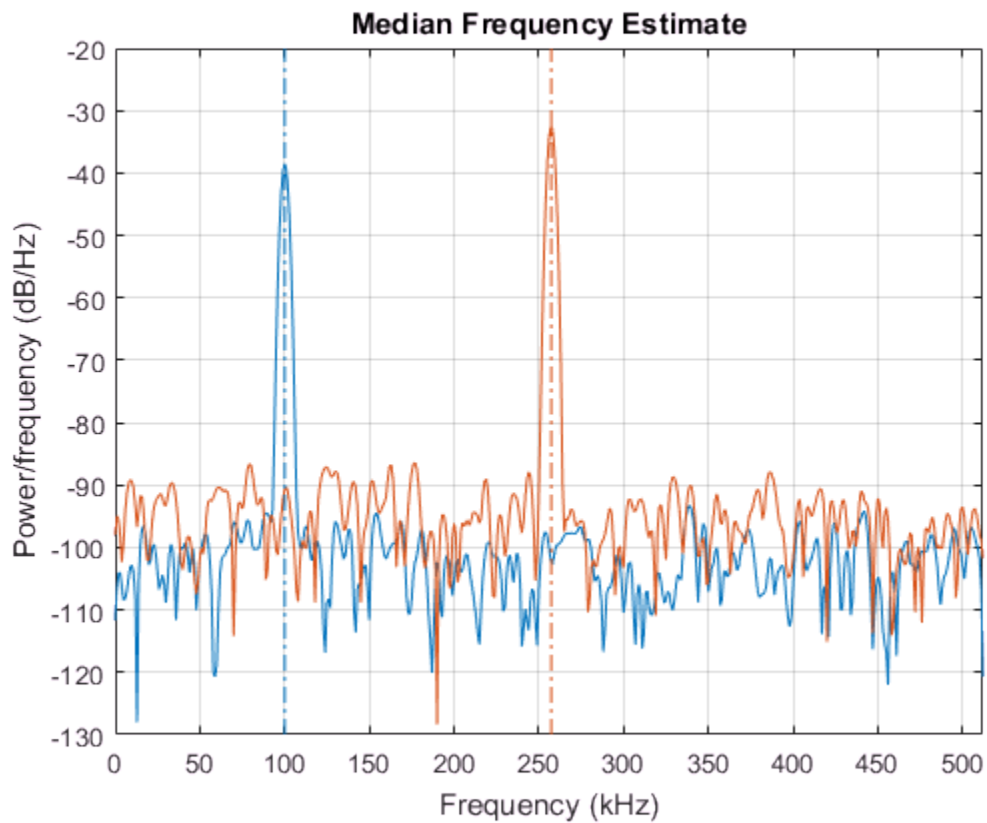

Add the two channels to form a new signal. Estimate the PSD and annotate the median frequency.

```
[Pzz,f] = periodogram(x+x2,kaiser(nSamp,38),[],Fs);
```

```
medfreq(Pzz,f);
```

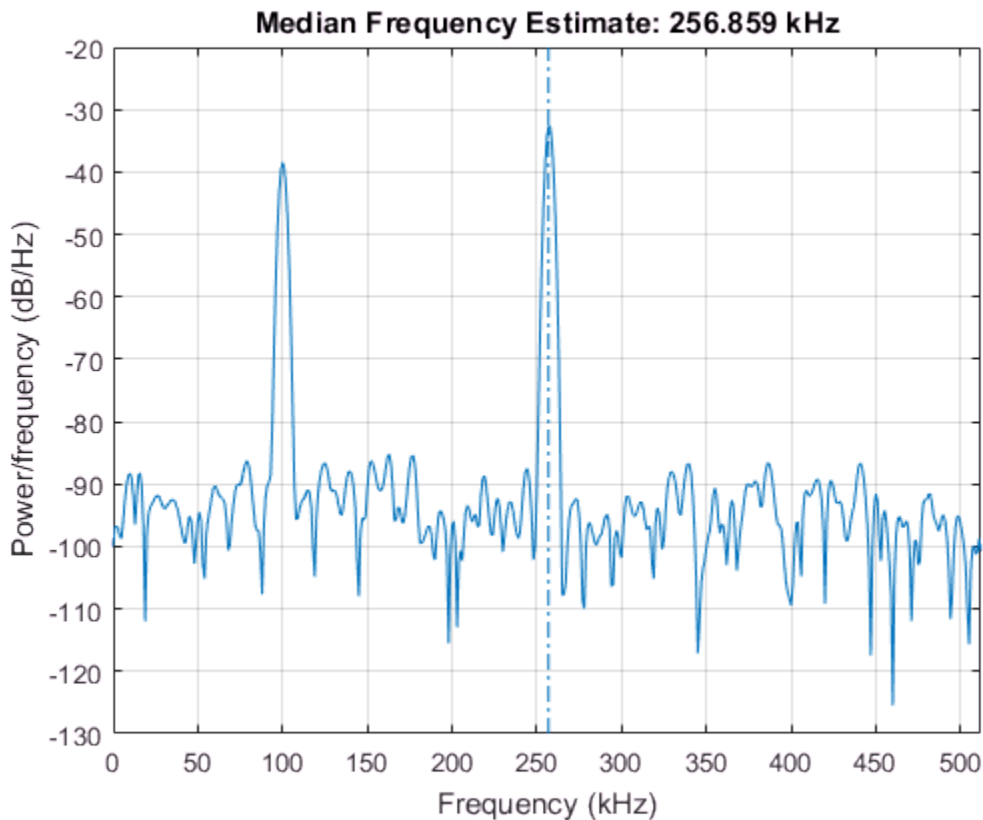

Median Frequency of Bandlimited Signals

Generate a signal whose PSD resembles the frequency response of an 88th-order bandpass FIR filter with normalized cutoff frequencies 0.25π rad/sample and 0.45π rad/sample.

```
d = fir1(88,[0.25 0.45]);
```

Compute the median frequency of the signal between 0.3π rad/sample and 0.6π rad/sample. Plot the PSD and annotate the median frequency and measurement interval.

```
medfreq(d,[],[0.3 0.6]*pi);
```

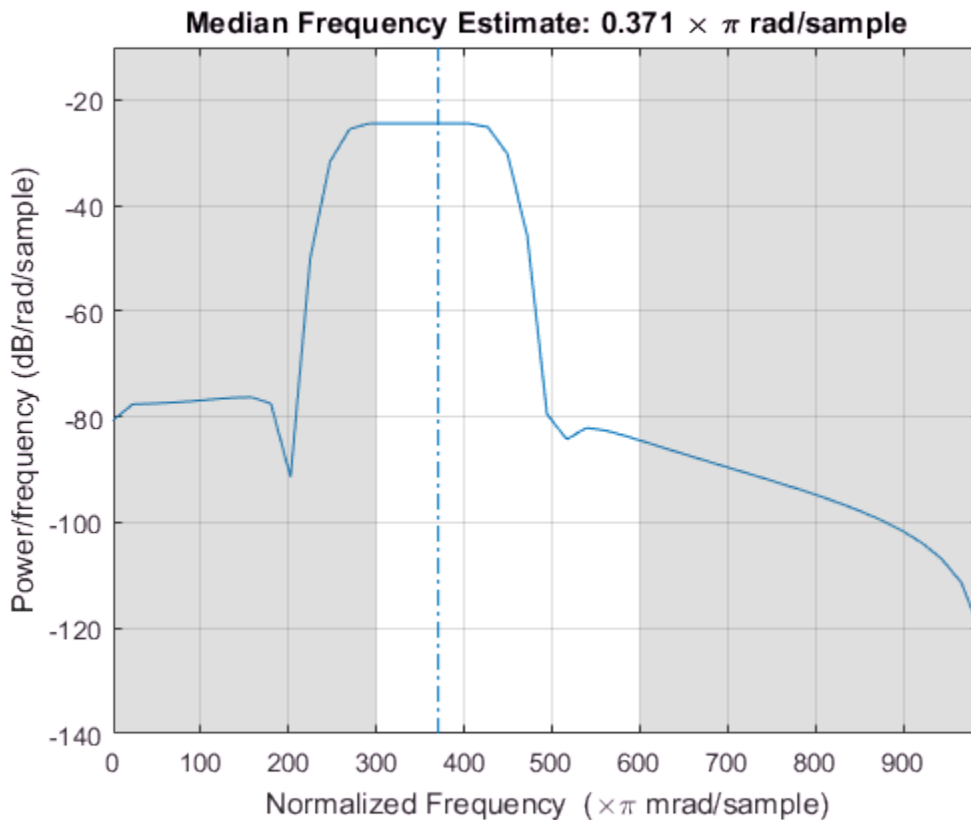

Output the median frequency and the band power of the measurement interval.

Specifying a sample rate of 2π is equivalent to leaving the rate unset.

```
[mdf,power] = medfreq(d,2*pi,[0.3 0.6]*pi);
```

```
fprintf('Mean = %.3f*pi, power = %.1f%% of total \n', ...
    mdf/pi,power/bandpower(d)*100)
```

```
Mean = 0.371*pi, power = 77.4% of total
```

Add a second channel with normalized cutoff frequencies 0.5π rad/sample and 0.8π rad/sample and an amplitude that is one-tenth that of the first channel.

```
d = [d;fir1(88,[0.5 0.8])/10]';
```

Compute the median frequency of the signal between 0.3π rad/sample and 0.9π rad/sample. Plot the PSD and annotate the median frequency of each channel and the measurement interval.

```
medfreq(d,[],[0.3 0.9]*pi);
```

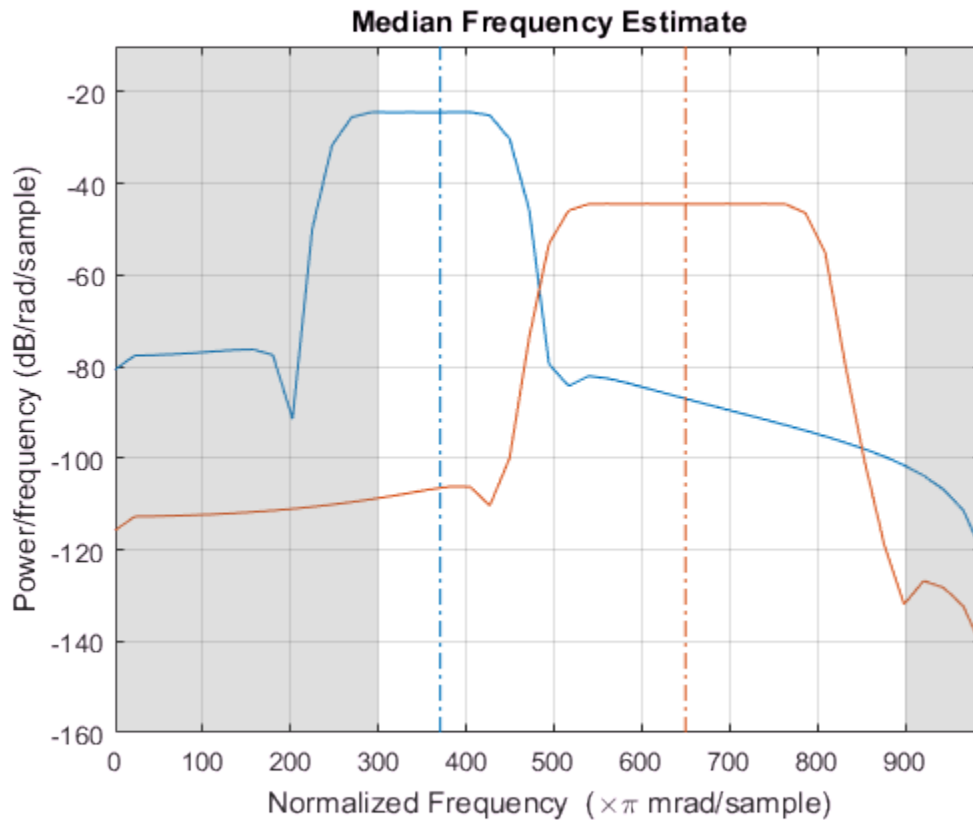

Output the median frequency of each channel. Divide by π .

```
mdf = medfreq(d,[],[0.3 0.9]*pi)/pi
```

```
mdf =
```

```
0.3706    0.6500
```

Input Arguments

x — Input signal

vector | matrix

Input signal, specified as a vector or matrix. If **x** is a vector, it is treated as a single channel. If **x** is a matrix, then `medfreq` computes the median frequency of each column of **x** independently. **x** must be finite-valued.

Example: `cos(pi/4*(0:159))+randn(1,160)` is a single-channel row-vector signal.

Example: `cos(pi./[4;2]*(0:159))'+randn(160,2)` is a two-channel signal.

Data Types: `single` | `double`

fs — Sample rate

positive real scalar

Sample rate, specified as a positive real scalar. The sample rate is the number of samples per unit time. If the time is measured in seconds, then the sample rate is in hertz.

Data Types: `single` | `double`

pxx — Power spectral density

vector | matrix

Power spectral density (PSD), specified as a vector or matrix. If **pxx** is a matrix, then `medfreq` computes the median frequency of each column of **pxx** independently.

Example: `periodogram(cos(pi./[4;2]*(0:159))'+randn(160,2))` is the periodogram PSD estimate of a two-channel sinusoid embedded in white Gaussian noise.

Data Types: `single` | `double`

f — Frequencies

vector

Frequencies, specified as a vector.

Data Types: `single` | `double`

sxx — Power spectrum estimate

vector | matrix

Power spectrum estimate, specified as a vector or matrix. If **sxx** is a matrix, then **medfreq** computes the median frequency of each column of **sxx** independently.

Example: `periodogram(cos(pi./[4;2]*(0:159))'+randn(160,2),'power')` is the periodogram power spectrum estimate of a two-channel sinusoid embedded in white Gaussian noise.

Data Types: single | double

rbw — Resolution bandwidth

positive scalar

Resolution bandwidth, specified as a positive scalar. The resolution bandwidth is the product of two values: the frequency resolution of the discrete Fourier transform and the equivalent noise bandwidth of the window used to compute the PSD.

Data Types: single | double

freqrange — Frequency range

two-element vector

Frequency range, specified as a two-element vector of real values. If you do not specify **freqrange**, then **medfreq** uses the entire bandwidth of the input signal.

Data Types: single | double

Output Arguments

freq — Median frequency

scalar | vector

Median frequency, specified as a scalar or vector.

- If you specify a sample rate, then **freq** has the same units as **fs**.
- If you do not specify a sample rate, then **freq** has units of rad/sample.

power — Band power

scalar | vector

Band power, returned as a scalar or vector.

See Also

See Also

`findpeaks` | `meanfreq` | `periodogram` | `plomb` | `pwelch`

Introduced in R2015a

midcross

Mid-reference level crossing for bilevel waveform

Syntax

```
C = midcross(X)
C = midcross(X,FS)
C = midcross(X,T)
[C,MIDLEV] = midcross(...)
C = midcross(X,Name,Value)
midcross(...)
```

Description

`C = midcross(X)` returns a vector, `C`, of time instants where each transition of the input signal, `X`, crosses the 50% reference level. The sample instants correspond to the indices of the input vector. Because `midcross` uses interpolation to determine the crossing instant, `C` may contain values that do not correspond to sampling instants. To determine the transitions, `midcross` estimates the state levels of `X` by a histogram method. `midcross` identifies all intervals which cross the upper-state boundary of the low state and the lower-state boundary of the high state. The low-state and high-state boundaries are expressed as the state level plus or minus a multiple of the difference between the state levels. See “State-Level Tolerances” on page 1-1269.

`C = midcross(X,FS)` specifies the sample rate, `FS`, in hertz as a positive scalar. The first sample instant corresponds to $t=0$. Because `midcross` uses interpolation to determine the crossing instant, `C` may contain values that do not correspond to sampling instants.

`C = midcross(X,T)` specifies the sample instants, `T`, as a vector with the same number of elements as `X`. Because `midcross` uses interpolation to determine the crossing instant, `C` may contain values that do not correspond to sampling instants.

`[C,MIDLEV] = midcross(...)` returns the waveform value corresponding to the mid-reference level.

`C = midcross(X,Name,Value)` returns the time instants corresponding to mid-reference level crossings with additional options specified by one or more `Name,Value` pair arguments.

`midcross(...)` plots the signal and marks the location of the mid-crossings (mid-reference level instants) and the associated reference levels. `midcross` also plots the state levels with upper and lower state boundaries.

Input Arguments

X

Bilevel waveform. `X` is a real-valued row or column vector.

FS

Sample rate in hertz.

T

Vector of sample instants. The length of `T` must equal the length of the bilevel waveform, `X`.

Name-Value Pair Arguments

Specify optional comma-separated pairs of `Name,Value` arguments. `Name` is the argument name and `Value` is the corresponding value. `Name` must appear inside single quotes (' '). You can specify several name and value pair arguments in any order as `Name1,Value1,...,NameN,ValueN`.

'MidPercentReferenceLevel'

Mid-reference level as a percentage of the waveform amplitude.

Default: 50

'StateLevels'

Low and high state levels. `StateLevels` is a 1-by-2 real-valued vector. The first element is the low state level. The second element is the high state level. If you do not specify

low- and high-state levels, `midcross` estimates the state levels from the input waveform using the histogram method.

'Tolerance'

Tolerance levels (lower- and upper-state boundaries) expressed as a percentage. See “State-Level Tolerances” on page 1-1269.

Default: 2

Output Arguments

c

Time instants of the mid-reference level crossings.

MIDLEV

Mid-reference level.

Examples

Mid-Reference Level Instant of Bilevel Waveform

Assuming a sampling interval of 1, compute the mid-reference level instant of a bilevel waveform. Plot the result.

```
load('transitionex.mat','x')
```

```
midcross(x)
```

```
ans = 21.5000
```

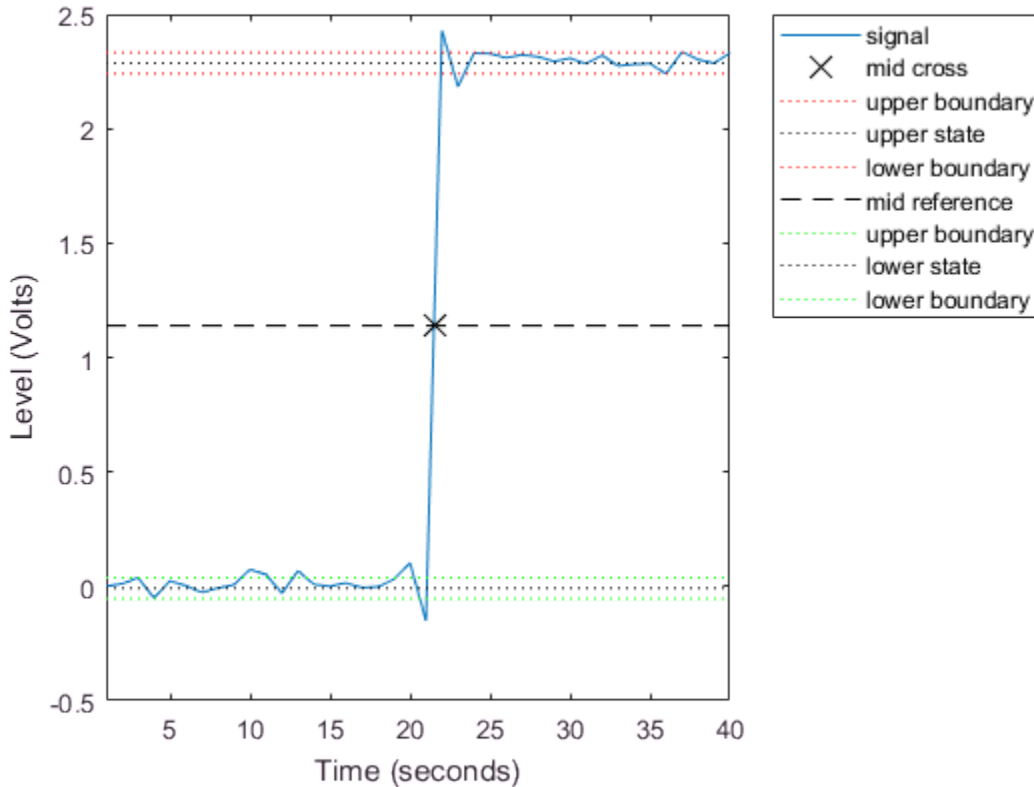

The instant at which the waveform crosses the 50% reference level is 21.5. This is not a sampling instant present in the input vector. `midcross` uses interpolation to identify the mid-reference level crossing.

Mid-Reference Level Instant with Sample Rate

Compute the mid-reference level instant for a sampled bilevel waveform. Use the time information to determine the sample rate, which is 4 MHz.

```
load('transitionx.mat','x','t')
Fs = 1/(t(2)-t(1))

Fs = 4000000
```

Use the sample rate to express the mid-reference level instant in seconds. Plot the waveform and annotate the result.

```
midcross(x,Fs)
```

```
ans = 5.1250e-06
```

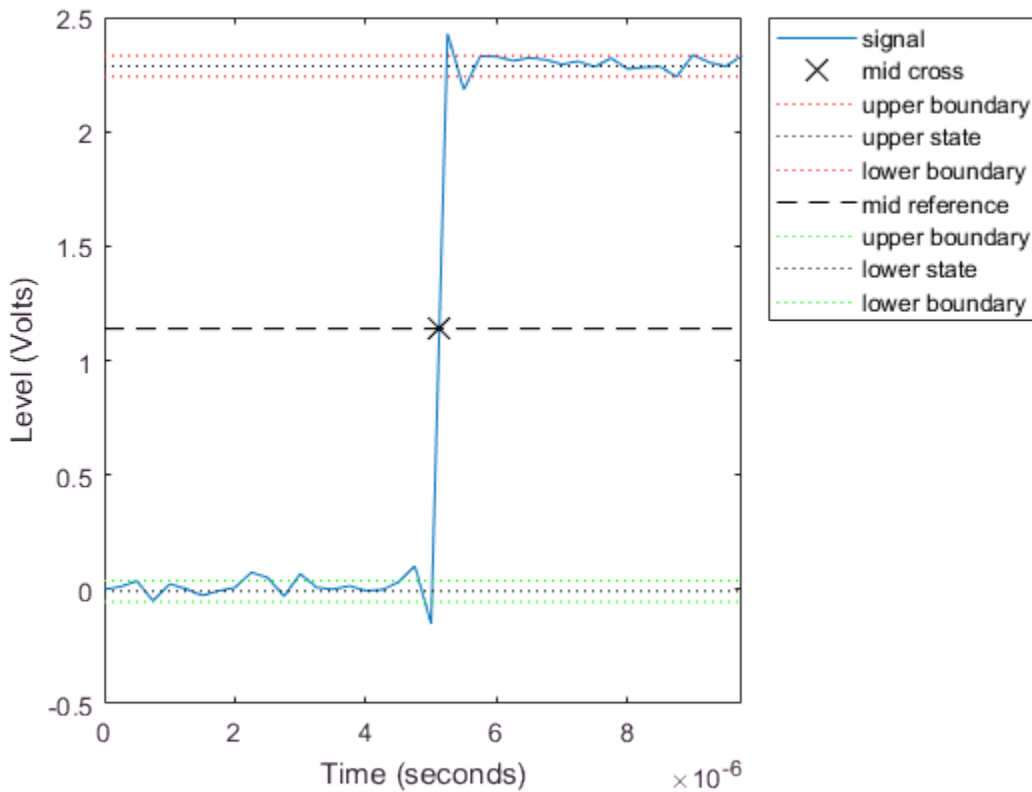

Mid-Reference Level Instant Using Sample Instants

Compute the mid-reference level instant using a vector of sample times equal in length to the bilevel waveform. The sample rate is 4 MHz.

```
load('transitionex.mat','x','t')
```

```
C = midcross(x,t)
```

C = 5.1250e-06

Annotate the result on a plot of the waveform.

```
midcross(x,t);
```

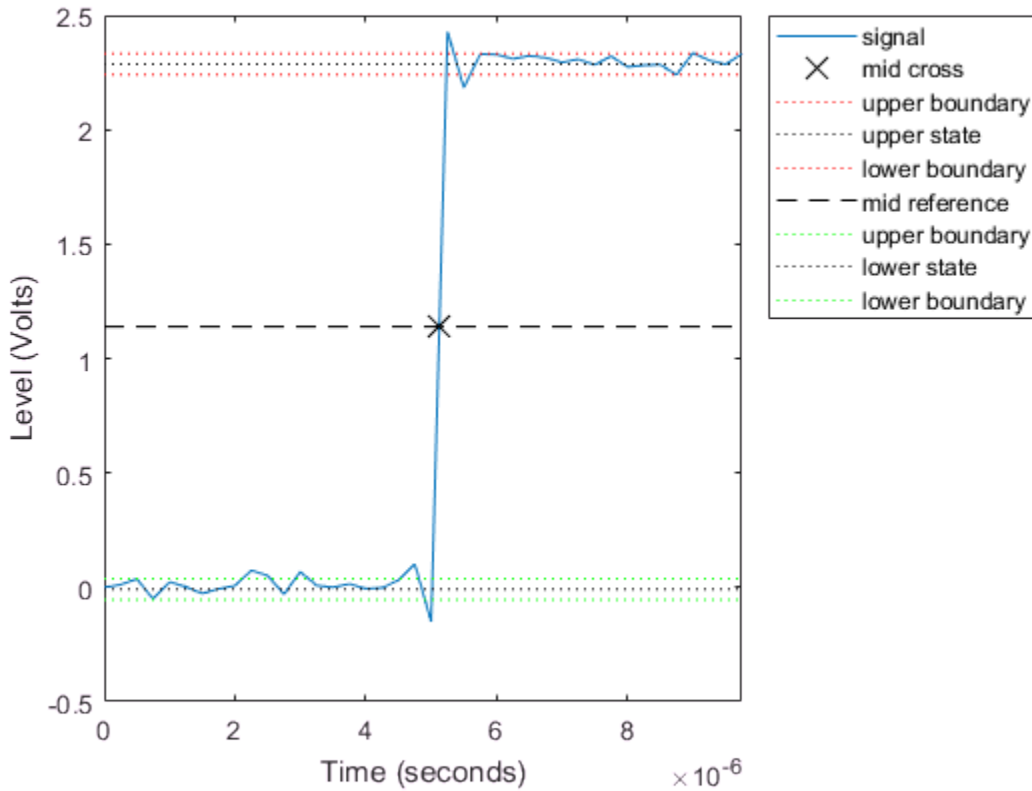

Mid-Reference Level Value of Bilevel Waveform

Compute the level corresponding to the mid-reference level instant.

```
load('transitionex.mat','x','t')
```

```
[~,midlev] = midcross(x,t)
```

```
midlev = 1.1388
```

Annotate the result on a plot of the waveform.

```
midcross(x,t);
```

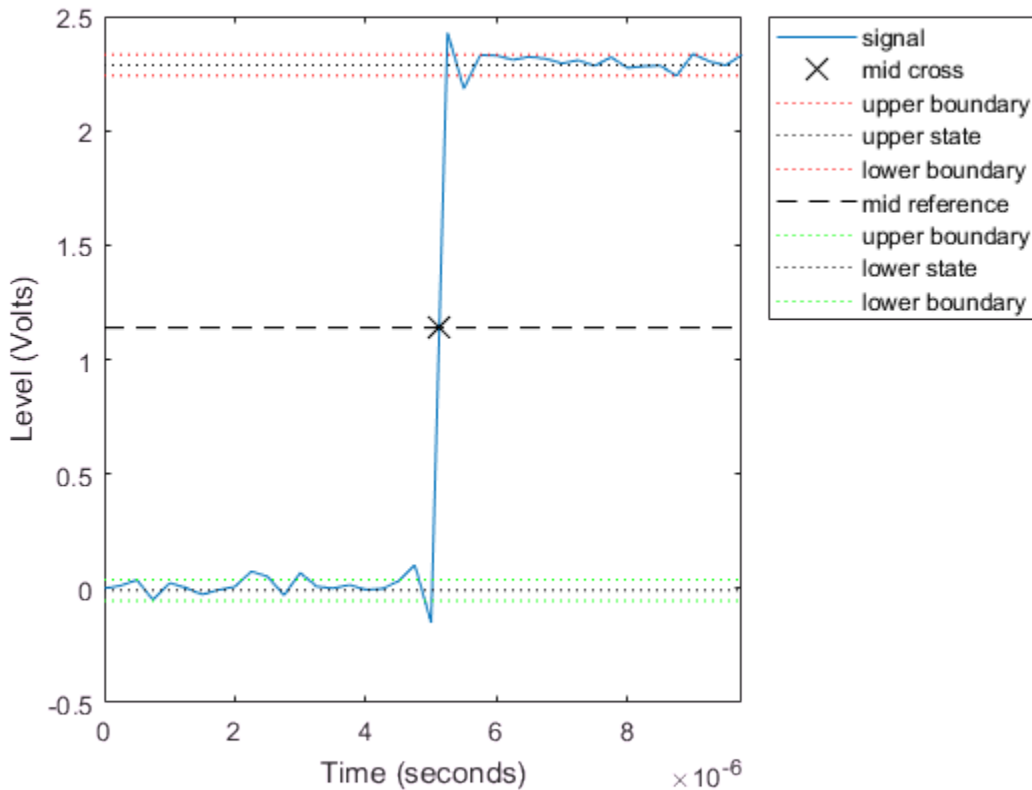

Sixty Percent Reference Level Instant and Waveform Value

Obtain the 60% reference level instant and value for a bilevel waveform sampled at 4 MHz.

```
load('transitionex.mat','x','t')
```

```
[mc,Lev60] = midcross(x,t,'MidPercentReferenceLevel',60)
```

```
mc = 5.1473e-06
```

Lev60 = 1.3682

Annotate the result on a plot of the waveform.

```
midcross(x,t, 'MidPercentReferenceLevel', 60);
```

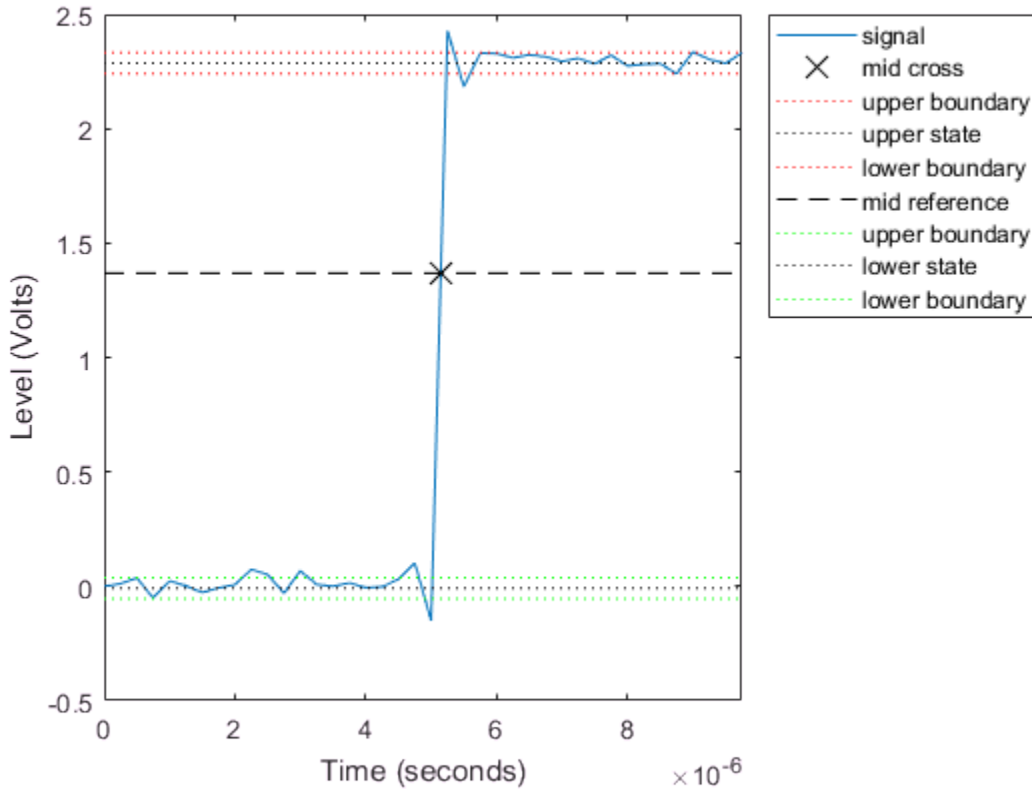

Definitions

Mid-Reference Level

The mid-reference level in a bilevel waveform with low-state level, S_1 , and high-state level, S_2 , is

$$S_1 + \frac{1}{2}(S_2 - S_1)$$

Mid Reference Level Instant

Let $y_{50\%}$ denote the mid-reference level.

Let $t_{50\%_-}$ and $t_{50\%_+}$ denote the two consecutive sampling instants corresponding to the waveform values nearest in value to $y_{50\%}$.

Let $y_{50\%_-}$ and $y_{50\%_+}$ denote the waveform values at $t_{50\%_-}$ and $t_{50\%_+}$.

The mid-reference level instant is

$$t_{50\%} = t_{50\%_+} + \left(\frac{t_{50\%_+} - t_{50\%_-}}{y_{50\%_+} - y_{50\%_-}} \right) (y_{50\%_+} - y_{50\%})$$

State-Level Tolerances

Each state level can have associated lower- and upper-state boundaries. These state boundaries are defined as the state level plus or minus a scalar multiple of the difference between the high state and the low state. To provide a useful tolerance region, the scalar is typically a small number such as 2/100 or 3/100. In general, the $\alpha\%$ region for the low state is defined as

$$S_1 \pm \frac{\alpha}{100}(S_2 - S_1),$$

where S_1 is the low-state level and S_2 is the high-state level. Replace the first term in the equation with S_2 to obtain the $\alpha\%$ tolerance region for the high state.

The following figure illustrates lower and upper 2% state boundaries (tolerance regions) for a positive-polarity bilevel waveform. The red dashed lines indicate the estimated state levels.

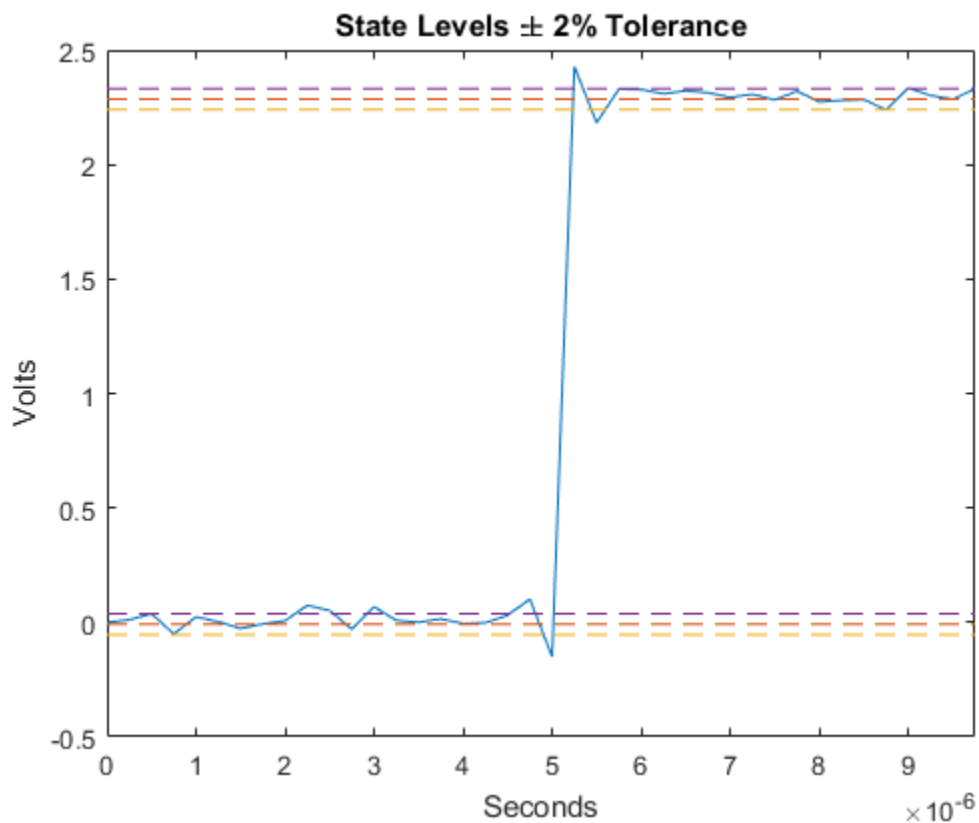

References

- [1] *IEEE Standard on Transitions, Pulses, and Related Waveforms*, IEEE Standard 181, 2003. p. 20.

See Also

See Also

`falltime` | `pulsewidth` | `risetime` | `settlingtime` | `statelevels`

Introduced in R2012a

modalfit

Modal parameters from frequency-response functions

Syntax

```
fn = modalfit(frf,f,fs,mnum)
```

```
fn = modalfit(frf,f,fs,mnum,Name,Value)
```

```
[fn,dr,ms] = modalfit(____)
```

```
[fn,dr,ms,ofrf] = modalfit(____)
```

Description

`fn = modalfit(frf,f,fs,mnum)` estimates the natural frequencies of `mnum` modes of a system having measured frequency-response functions `frf` defined at frequencies `f` and for a sample rate `fs`.

`fn = modalfit(frf,f,fs,mnum,Name,Value)` specifies options using name-value pair arguments.

`[fn,dr,ms] = modalfit(____)` also returns the damping ratios and mode-shape vectors corresponding to each natural frequency in `fn`, using any combination of inputs from previous syntaxes.

`[fn,dr,ms,ofrf] = modalfit(____)` also returns a reconstructed frequency-response function array based on the estimated modal parameters.

Examples

Frequency-Response Function of SISO System

Estimate the frequency-response function for a simple single-input/single-output system and compare it to the definition.

A one-dimensional discrete-time oscillating system consists of a unit mass, m , attached to a wall by a spring with unit elastic constant. A sensor samples the displacement of the mass at $F_s = 1$ Hz. A damper impedes the motion of the mass by exerting on it a force proportional to speed, with damping constant $b = 0.01$.

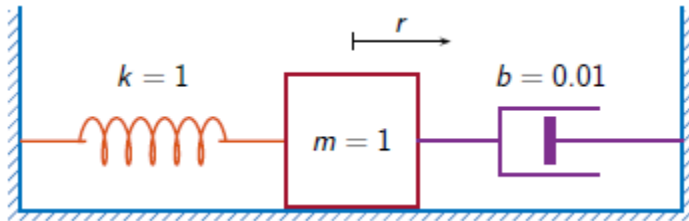

Generate 3000 time samples. Define the sampling interval $\Delta t = 1/F_s$.

```

Fs = 1;
dt = 1/Fs;
N = 3000;
t = dt*(0:N-1);
b = 0.01;

```

The system can be described by the state-space model

$$\begin{aligned} x(k+1) &= Ax(k) + Bu(k), \\ y(k) &= Cx(k) + Du(k), \end{aligned}$$

where $x = [r \ v]^T$ is the state vector, r and v are respectively the displacement and velocity of the mass, u is the driving force, and $y = r$ is the measured output. The state-space matrices are

$$A = \exp(A_c \Delta t), \quad B = A_c^{-1}(A - I)B_c, \quad C = [1 \ 0], \quad D = 0,$$

I is the 2×2 identity, and the continuous-time state-space matrices are

$$A_c = \begin{bmatrix} 0 & 1 \\ -1 & -b \end{bmatrix}, \quad B_c = \begin{bmatrix} 0 \\ 1 \end{bmatrix}.$$

```
Ac = [0 1; -1 -b];  
A = expm(Ac*dt);  
  
Bc = [0;1];  
B = Ac\ (A-eye(2))*Bc;  
  
C = [1 0];  
D = 0;
```

The mass is driven by random input for the first 2000 seconds and then left to return to rest. Use the state-space model to compute the time evolution of the system starting from an all-zero initial state. Plot the displacement of the mass as a function of time.

```
rng default  
u = randn(1,N)/2;  
u(2001:end) = 0;  
  
y = 0;  
x = [0;0];  
for k = 1:N  
    y(k) = C*x + D*u(k);  
    x = A*x + B*u(k);  
end  
  
plot(t,y)
```

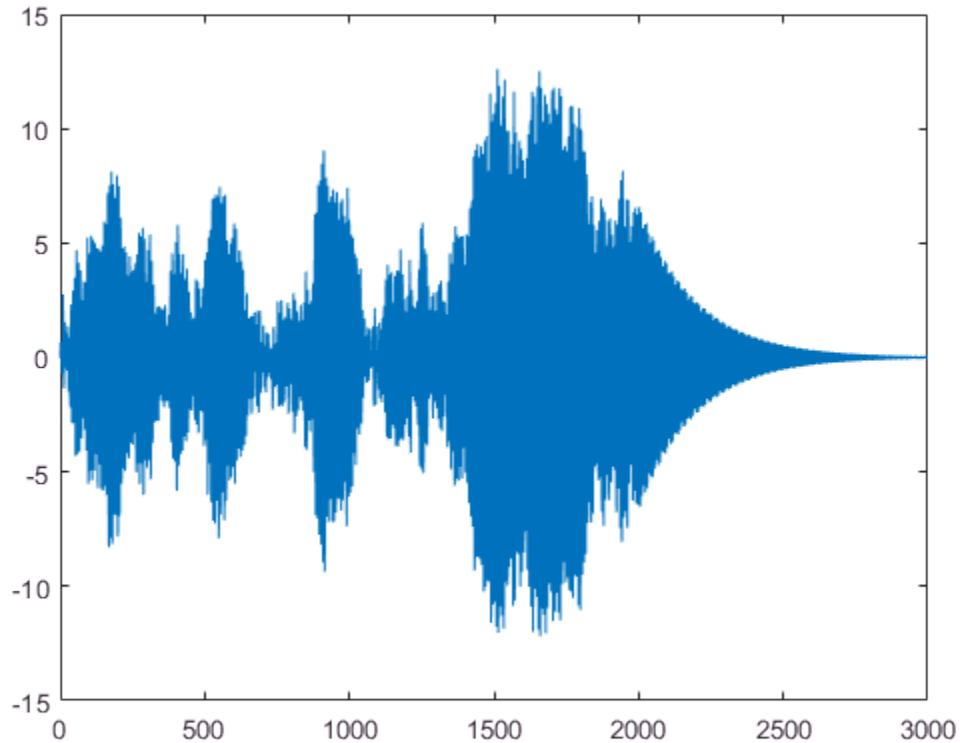
Estimate the modal frequency-response function of the system. Use a Hann window half as long as the measured signals. Specify that the output is the displacement of the mass.

```
wind = hann(N/2);
```

```
[frf,f] = modalfrf(u',y',Fs,wind,'Sensor','dis');
```

The frequency-response function of a discrete-time system can be expressed as the Z-transform of the time-domain transfer function of the system, evaluated at the unit circle. Compare the `modalfrf` estimate with the definition.

```
[b,a] = ss2tf(A,B,C,D);
```

```
nfs = 2048;
```

```

fz = 0:1/nfs:1/2-1/nfs;
z = exp(2j*pi*fz);
ztf = polyval(b,z)./polyval(a,z);

plot(f,20*log10(abs(frf)))
hold on
plot(fz*Fs,20*log10(abs(ztf)))
hold off
grid
ylim([-60 40])

```

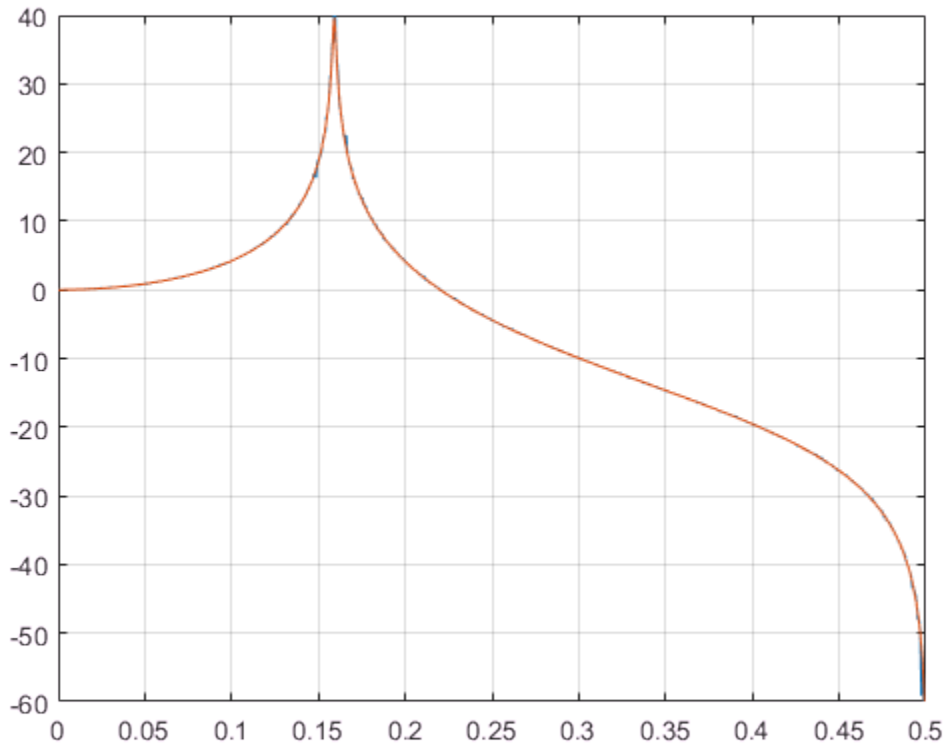

Estimate the natural frequency and the damping ratio for the vibration mode.

```
[fn,dr] = modalfit(frf,f,Fs,1,'FitMethod','PP')
```

$$f_n = 0.1593$$

$$d_r = 0.0043$$

Compare the natural frequency to $1/2\pi$, which is the theoretical value for the undamped system.

$$\text{theo} = 1/(2*\pi)$$

$$\text{theo} = 0.1592$$

Modal Parameters of Two-Body Oscillator

Estimate the frequency-response function and modal parameters of a simple multi-input/multi-output system.

An ideal one-dimensional oscillating system consists of two masses, m_1 and m_2 , confined between two walls. The units are such that $m_1 = 1$ and $m_2 = \mu$. Each mass is attached to the nearest wall by a spring with an elastic constant k . An identical spring connects the two masses. Three dampers impede the motion of the masses by exerting on them forces proportional to speed, with damping constant b . Sensors sample r_1 and r_2 , the displacements of the masses, at $F_s = 50$ Hz.

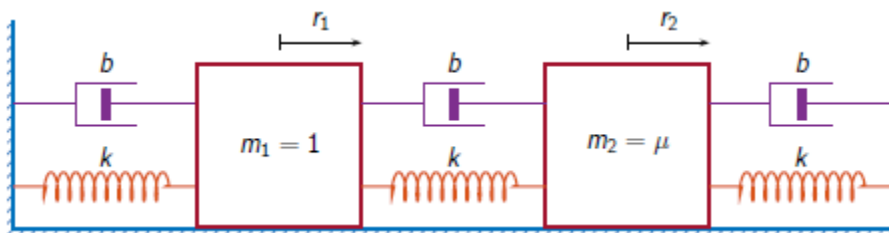

Generate 30000 time samples, equivalent to 600 seconds. Define the sampling interval

$$\Delta t = 1/F_s$$

$$F_s = 50;$$

```
dt = 1/Fs;
N = 30000;
t = dt*(0:N-1);
```

The system can be described by the state-space model

$$\begin{aligned}x(k+1) &= Ax(k) + Bu(k), \\y(k) &= Cx(k) + Du(k),\end{aligned}$$

where $x = [r_1 \ v_1 \ r_2 \ v_2]^T$ is the state vector, r_i and v_i are respectively the location and the velocity of the i -th mass, $u = [u_1 \ u_2]^T$ is the vector of input driving forces, and $y = [r_1 \ r_2]^T$ is the output vector. The state-space matrices are

$$A = \exp(A_c \Delta t), \quad B = A_c^{-1}(A - I)B_c, \quad C = \begin{bmatrix} 1 & 0 & 0 & 0 \\ 0 & 0 & 1 & 0 \end{bmatrix}, \quad D = \begin{bmatrix} 0 & 0 \\ 0 & 0 \end{bmatrix},$$

I is the 4×4 identity, and the continuous-time state-space matrices are

$$A_c = \begin{bmatrix} 0 & 1 & 0 & 0 \\ -2k & -2b & k & b \\ 0 & 0 & 0 & 1 \\ k/\mu & b/\mu & -2k/\mu & -2b/\mu \end{bmatrix}, \quad B_c = \begin{bmatrix} 0 & 0 \\ 1 & 0 \\ 0 & 0 \\ 0 & 1/\mu \end{bmatrix}.$$

Set $k = 400$, $b = 0.1$, and $\mu = 1/10$.

```
k = 400;
b = 0.1;
m = 1/10;
```

```
Ac = [0 1 0 0; -2*k -2*b k b; 0 0 0 1; k/m b/m -2*k/m -2*b/m];
A = expm(Ac*dt);
Bc = [0 0; 1 0; 0 0; 0 1/m];
B = Ac \ (A - eye(4)) * Bc;
C = [1 0 0 0; 0 0 1 0];
```

```
D = zeros(2);
```

The masses are driven by random input throughout the measurement. Use the state-space model to compute the time evolution of the system starting from an all-zero initial state.

```
rng default
u = randn(2,N);

y = [0;0];
x = [0;0;0;0];
for kk = 1:N
    y(:,kk) = C*x + D*u(:,kk);
    x = A*x + B*u(:,kk);
end
```

Use the input and output data to estimate the transfer function of the system as a function of frequency. Use a 5000-sample Hann window with 3000 samples of overlap between adjoining segments. Specify that the measured outputs are displacements.

```
wind = hann(15000);
nove = 9000;
[FRF,f] = modalfrf('u','y',Fs,wind,nove,'Sensor','dis');
```

Compute the theoretical transfer function as the Z-transform of the time-domain transfer function, evaluated at the unit circle.

```
nfs = 2048;
fz = 0:1/nfs:1/2-1/nfs;
z = exp(2j*pi*fz);

[b1,a1] = ss2tf(A,B,C,D,1);
[b2,a2] = ss2tf(A,B,C,D,2);

frf(1,:,1) = polyval(b1(1,:),z)./polyval(a1,z);
frf(1,:,2) = polyval(b1(2,:),z)./polyval(a1,z);
frf(2,:,1) = polyval(b2(1,:),z)./polyval(a2,z);
frf(2,:,2) = polyval(b2(2,:),z)./polyval(a2,z);
```

Plot the estimates and overlay the theoretical predictions.

```
for jk = 1:2
    for kj = 1:2
        subplot(2,2,2*(jk-1)+kj)
```

```

plot(f,20*log10(abs(FRF(:,jk,kj))))
hold on
plot(fz*Fs,20*log10(abs(frf(jk,:,kj))))
hold off
axis([0 Fs/2 -100 0])
title(sprintf('Input %d, Output %d',jk,kj))
end
end

```

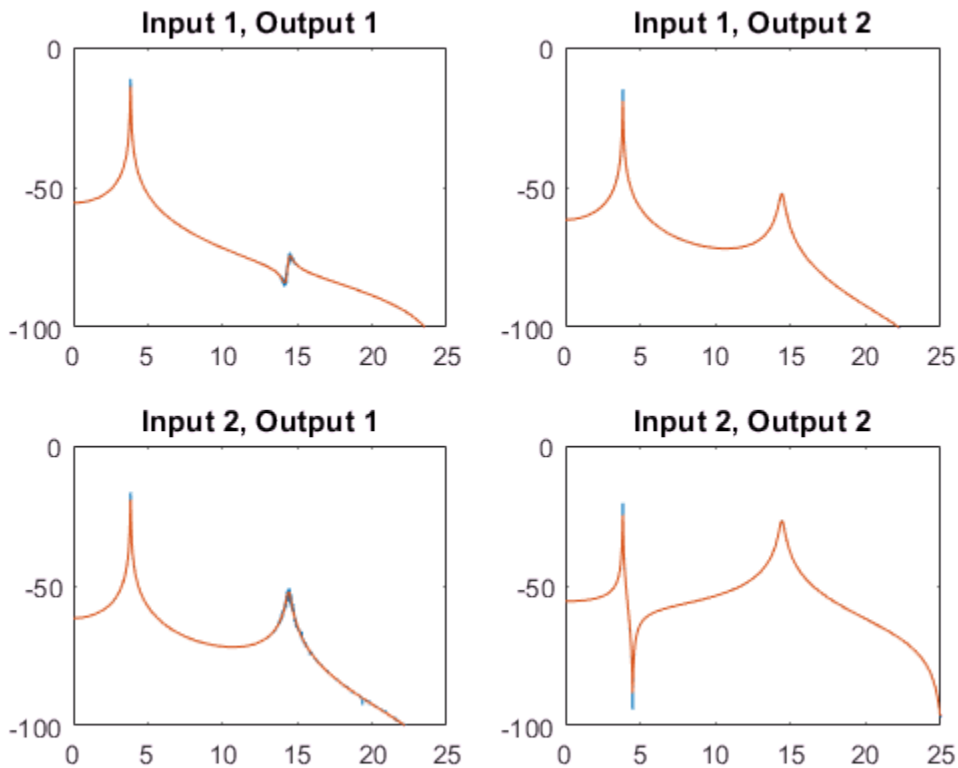

Plot the estimates using the built-in functionality of `modalfrf`.

```

figure
modalfrf(u',y',Fs,wind,nove,'Sensor','dis')

```

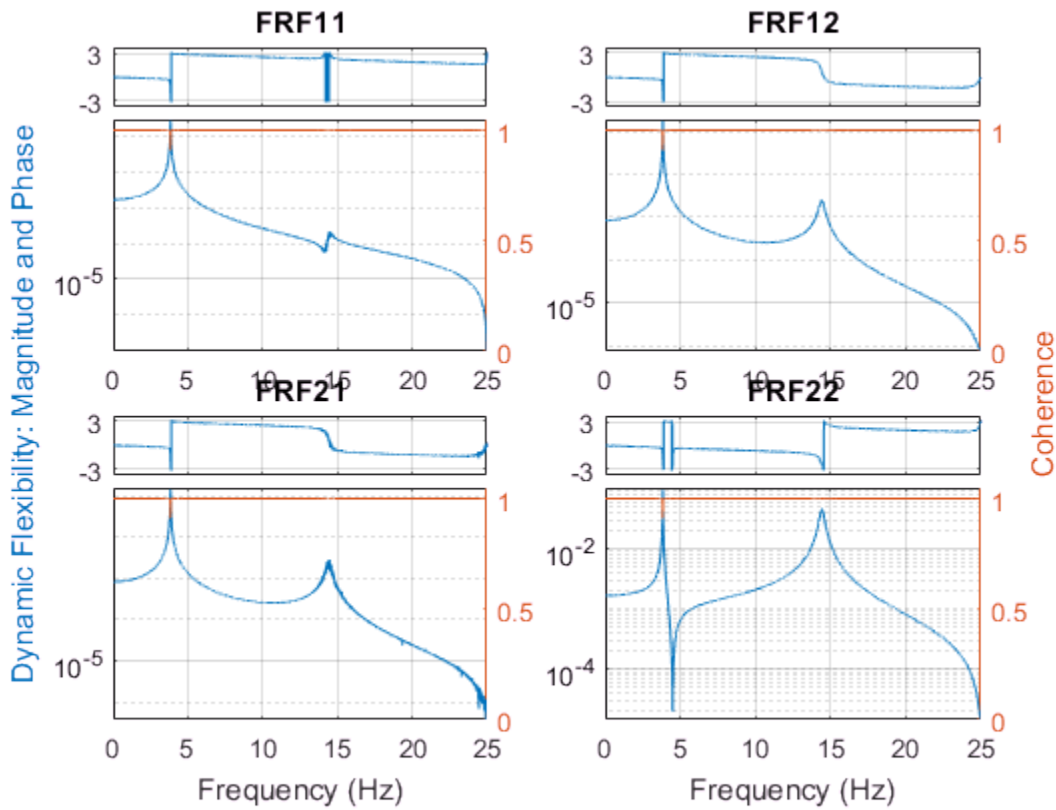

Estimate the natural frequencies, damping ratios, and mode shapes of the system. Use the peak-picking method for the calculation.

```
[fn,dr,ms] = modalfit(FRF,f,Fs,2,'FitMethod','pp');
fn
```

fn =

(:,: ,1) =

```
    3.8466    3.8466
    3.8495    3.8495
```

```
(:, :, 2) =  
  
    3.8492    3.8490  
    3.8552    14.4684
```

Compare the natural frequencies to the theoretical predictions for the undamped system.

```
undamped = sqrt(eig([2*k -k; -k/m 2*k/m]))/2/pi
```

```
undamped =
```

```
    3.8470  
    14.4259
```

Modal Parameters of MIMO System

Compute the natural frequencies, the damping ratios, and the mode shapes for a three-output, two-input system excited by several bursts of random noise. Each burst lasts for 1 second, and there are 2 seconds between the end of each burst and the start of the next. The data are sampled at 4 kHz.

Load the data file. Plot the input signals and the output signals.

```
load modaldata  
  
subplot(2,1,1)  
plot(Xburst)  
title('Input Signals')  
subplot(2,1,2)  
plot(Yburst)  
title('Output Signals')
```

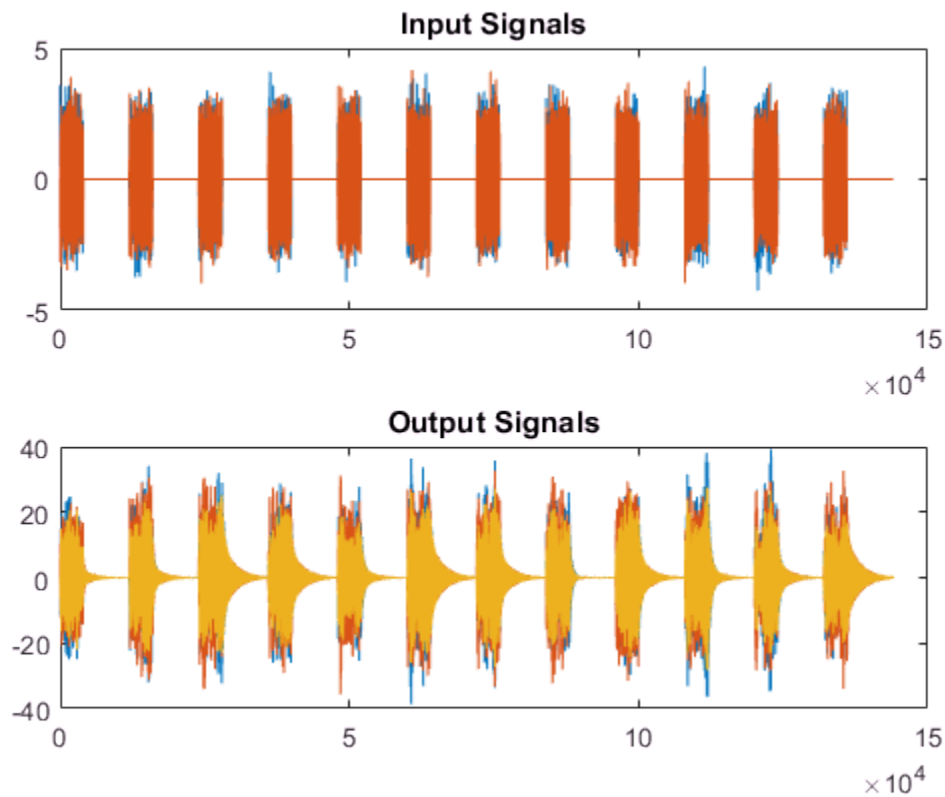



Compute the frequency-response functions. Specify a rectangular window with length equal to the burst period and zero overlap between adjoining segments.

```
burstLen = 12000;
[frf,f] = modalfrf(Xburst,Yburst,fs,burstLen);
```

Visualize a stabilization diagram and return the stable natural frequencies. Specify a maximum model order of 30 modes.

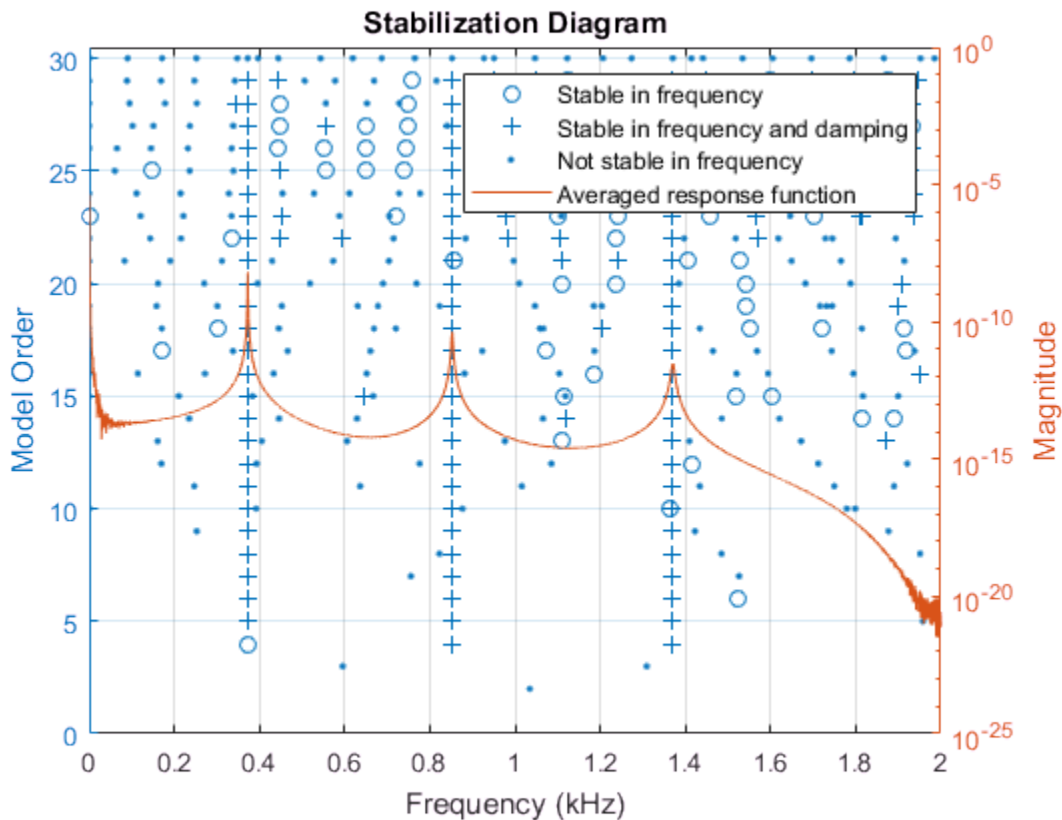
```
figure
fn = modalsd(frf,f,fs,'MaxModes',30);
```



Zoom in on the plot. The averaged response function has maxima at 373 Hz, 852 Hz, and 1371 Hz, which correspond to the physical frequencies of the system. Save the maxima to a variable.

```
phfr = [373 852 1371];
```

Compute the modal parameters using the LSCE algorithm. Specify a model order of 6 modes and specify physical frequencies for 3 modes previously determined using a stabilization diagram. The function generates one set of natural frequencies and damping ratios for each input reference.

```
[fn,dr,ms,ofrf] = modalfit(frf,f,fs,6,'PhysFreq',phfr);
```

Plot the reconstructed frequency-response functions and compare them to the original ones.

```
for k = 1:2
    for m = 1:3
        subplot(2,3,m+3*(k-1))
        plot(f/1000,10*log10(abs(frf(:,m,k))))
        hold on
        plot(f/1000,10*log10(abs(ofrf(:,m,k))))
        hold off
        text(1,-50,['Output ';' Input '] num2str([m k]'))
        ylim([-100 -40])
    end
end
subplot(2,3,2)
title('Frequency-Response Functions')
```

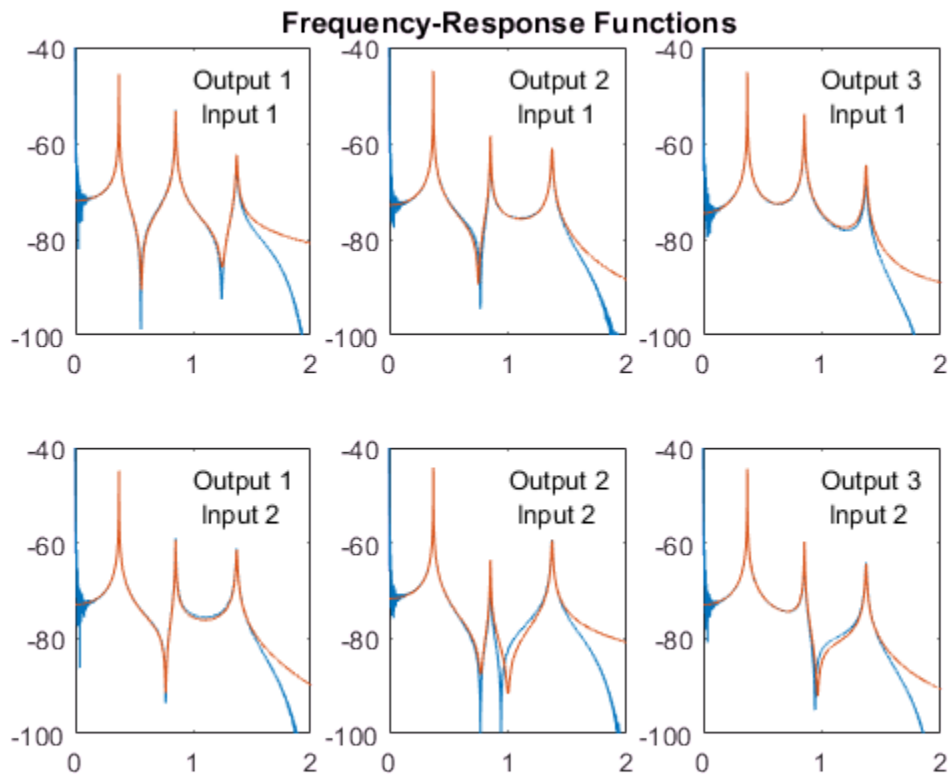

Input Arguments

frf — Frequency-response functions

vector | matrix | 3-D array

Frequency-response functions, specified as a vector, matrix, or 3-D array. `frf` has size p -by- m -by- n , where p is the number of frequency bins, m is the number of response signals, and n is the number of excitation signals used to estimate the transfer function.

Example:

```
tffestimate(randn(1,1000),sin(2*pi*(1:1000)/4)+randn(1,1000)/10)
```

approximates the frequency response of an oscillator.

Data Types: `single` | `double`

Complex Number Support: Yes

f — Frequencies

vector

Frequencies, specified as a vector. The number of elements of `f` must equal the number of rows of `frf`.

Data Types: `single` | `double`

fs — Sample rate of measurement data

positive scalar

Sample rate of measurement data, specified as a positive scalar expressed in hertz.

Data Types: `single` | `double`

mnum — Number of modes

positive integer

Number of modes, specified as a positive integer.

Data Types: `single` | `double`

Name-Value Pair Arguments

Specify optional comma-separated pairs of `Name`, `Value` arguments. `Name` is the argument name and `Value` is the corresponding value. `Name` must appear inside single quotes (' '). You can specify several name and value pair arguments in any order as `Name1, Value1, ..., NameN, ValueN`.

Example: `'FitMethod','pp','FreqRange',[0 500]` uses the peak-picking method to perform the fit and restricts the frequency range to between 0 and 500 Hz.

'FitMethod' — Fitting algorithm

`'lsce'` (default) | `'pp'`

Fitting algorithm, specified as the comma-separated pair consisting of `'FitMethod'` and `'lsce'` or `'pp'`.

- `'lsce'` — “Least-Squares Complex Exponential Method” on page 1-1289. If you specify `'lsce'`, then `fn` is a vector with `mnum` elements, independent of the size of `frf`.
- `'pp'` — “Peak-Picking Method” on page 1-1291. For an `frf` computed from n excitation signals and m response signals, `fn` is an `mnum`-by- m -by- n array with one estimate of `fn` and one estimate of `dr` per `frf`.

Data Types: `char`

'FreqRange' — Frequency range

positive two-element vector

Frequency range, specified as the comma-separated pair consisting of `'FreqRange'` and a positive two-element vector of increasing values contained within the range specified in `f`.

Data Types: `single` | `double`

'PhysFreq' — Natural frequencies for physical modes

vector

Natural frequencies for physical modes to include in the analysis, specified as the comma-separated pair consisting of `'PhysFreq'` and a vector of frequency values within the range spanned by `f`. The function includes in the analysis those modes with natural frequencies closest to the values specified in the vector. If the vector contains m frequency values, then `fn` and `dr` have m rows each, and `ms` has m columns. If you do not specify this argument, then the function uses the entire frequency range in `f`.

Data Types: `single` | `double`

'DriveIndex' — Indices of the driving-point frequency-response function

[1 1] (default) | two-element vector of positive integers

Indices of the driving-point frequency-response function, specified as the comma-separated pair consisting of `'DriveIndex'` and a two-element vector of positive integers. The first element of the vector must be less than or equal to the number of system responses. The second element of the vector must be less than or equal to the number of system excitations. Mode shapes are normalized to unity modal based on the driving point.

Example: `'DriveIndex', [2 3]` specifies that the driving-point frequency-response function is `frf(:,2,3)`.

Data Types: `single` | `double`

Output Arguments

fn — Natural frequencies

matrix | 3-D array

Natural frequencies, returned as a matrix or 3-D array. The size of **fn** depends on the choice of fitting algorithm specified with 'FitMethod'

- If you specify 'lsce', then **fn** is a vector with **mnum** elements, independent of the size of **frf**.
- If you specify 'pp', then **fn** is a **mnum-by-m-by-n** array with one estimate of **fn** and one estimate of **dr** per **frf**.

dr — Damping ratios

matrix | 3-D array

Damping ratios for the natural frequencies in **fn**, returned as a matrix or 3-D array of the same size as **fn**.

ms — Mode-shape vectors

matrix

Mode-shape vectors, returned as a matrix. **ms** has **mnum** columns, each containing a mode-shape vector of length q , where q is the larger of the number of excitation channels and the number of response channels.

ofrf — Reconstructed frequency-response functions

vector | matrix | 3-D array

Reconstructed frequency-response functions, returned as a vector, matrix, or 3-D array with the same size as **frf**.

Algorithms

Least-Squares Complex Exponential Method

The least-squares complex exponential method computes the impulse response corresponding to each frequency-response function and fits to the response a set of complex damped sinusoids using Prony's method.

A sampled damped sinusoid can be cast in the form

$$\begin{aligned} s_i(n) &= A_i e^{-b_i n/f_s} \cos(2\pi f_i n/f_s + \phi_i) \\ &= \frac{1}{2} A_i e^{j\phi_i} \exp(-(b_i/f_s - j2\pi f_i/f_s)n) + \frac{1}{2} A_i e^{-j\phi_i} \exp(-(b_i/f_s + j2\pi f_i/f_s)n) \\ &\equiv a_{i+} x_{i+}^n + a_{i-} x_{i-}^n, \end{aligned}$$

where:

- f_s is the sample rate.
- f_i is the sinusoid frequency.
- b_i is the damping coefficient.
- A_i and ϕ_i are the amplitude and phase of the sinusoid.

The a_i are called *amplitudes* and the x_i are called *poles*. Prony's method expresses a sampled function $h(n)$ as a superposition of $N/2$ modes (and thus N amplitudes and poles):

$$\begin{aligned} h(0) &= a_1 x_1^0 + a_2 x_2^0 \cdots + a_N x_N^0 \\ h(1) &= a_1 x_1^1 + a_2 x_2^1 + \cdots + a_N x_N^1 \\ &\vdots \\ h(N-1) &= a_1 x_1^{N-1} + a_2 x_2^{N-1} + \cdots + a_N x_N^{N-1}. \end{aligned}$$

The poles are the roots of a polynomial with coefficients c_0, c_1, \dots, c_{N-1} ,

$$x_i^N + c_{N-1} x_i^{N-1} + \cdots + c_1 x_i^1 + c_0 x_i^0 = 0.$$

The coefficients are found using an autoregressive model of $L = 2N$ samples of h :

$$\begin{bmatrix} h(0) & h(1) & \cdots & h(N-1) \\ h(1) & h(2) & \cdots & h(N) \\ \vdots & \vdots & \ddots & \vdots \\ h(L-N-1) & h(L-N) & \cdots & h(L-2) \end{bmatrix} \begin{bmatrix} c_0 \\ c_1 \\ \vdots \\ c_{N-1} \end{bmatrix} = - \begin{bmatrix} h(N) \\ h(N+1) \\ \vdots \\ h(L-1) \end{bmatrix}.$$

To find the poles, the algorithm uses the `roots` function. Once the poles are known, it is possible to determine the frequencies and damping factors by identifying the imaginary

and real parts of the pole logarithms. The final step is solving for the amplitudes and reconstructing the impulse response using

$$\begin{bmatrix} h(0) \\ \vdots \\ h(N-1) \end{bmatrix} = \begin{bmatrix} x_1^0 & \cdots & x_N^0 \\ \vdots & \ddots & \vdots \\ x_1^{N-1} & \cdots & x_N^{N-1} \end{bmatrix} \begin{bmatrix} a_1 \\ \vdots \\ a_N \end{bmatrix}.$$

The following naive MATLAB implementation summarizes the procedure:

```
N = 4;
L = 2*N;
h = rand(L,1);
c = hankel(h(1:N),h(L-N:L-1))\-h(N+1:L);
x = roots([1;c(N:-1:1)]).';
p = log(x);
hrec = x.^((0:L-1)')*(x.^((0:L-1)')\h(1:L));
sum(h-hrec)
```

ans =

```
3.2613e-15 - 1.9297e-16i
```

The system can also be constructed to contain samples from multiple frequency-response functions, and solved using least squares.

Peak-Picking Method

The peak-picking method assumes that each significant peak in the frequency-response function corresponds to one and only one natural mode. Close to a peak, the system is assumed to behave like a one-degree-of-freedom damped harmonic oscillator:

$$H(f) = \frac{1}{(2\pi)^2} \frac{1/m}{-f^2 + j2\zeta_r f_r f + f_r^2} \Rightarrow H(f_i) f_r^2 - j2\zeta_r f_r f_i H(f_i) - 1/m = f_i^2 H(f_i),$$

where H is the frequency-response function, f_r is the undamped resonance frequency, $\zeta_r = b/(4mk)^{1/2}$ is the relative damping, b is the damping constant, k is the elastic constant, and m is the mass.

Given a peak located at f_p , the procedure takes the peak and a fixed number of points to either side and computes the modal parameters by solving the system of equations

$$\begin{bmatrix} H(f_{p-k}) & j2f_{p-k}H(f_{p-k}) & -1 \\ \vdots & \vdots & \vdots \\ H(f_p) & j2f_pH(f_p) & -1 \\ \vdots & \vdots & \vdots \\ H(f_{p+k}) & j2f_{p+k}H(f_{p+k}) & -1 \end{bmatrix} \begin{bmatrix} f_r^2 \\ \zeta_r f_r \\ d \end{bmatrix} = \begin{bmatrix} f_{p-k}^2 H(f_{p-k}) \\ \vdots \\ f_p^2 H(f_p) \\ \vdots \\ f_{p+k}^2 H(f_{p+k}) \end{bmatrix}.$$

References

- [1] Allemang, Randall J., and David L. Brown. “Experimental Modal Analysis and Dynamic Component Synthesis, Vol. III: Modal Parameter Estimation.” Technical Report AFWAL-TR-87-3069. Air Force Wright Aeronautical Laboratories, Wright-Patterson Air Force Base, OH, December 1987.
- [2] Brandt, Anders. *Noise and Vibration Analysis: Signal Analysis and Experimental Procedures*. Chichester, UK: John Wiley & Sons, 2011.

See Also

See Also

modalfrf | modalsd | tfestimate

Introduced in R2017a

modalfrf

Frequency-response functions for modal analysis

Syntax

```
frf = modalfrf(x,y,fs>window)
frf = modalfrf(x,y,fs>window,noverlap)

frf = modalfrf( ____,Name,Value)

[frf,f,coh] = modalfrf( ____ )

modalfrf( ____ )
```

Description

`frf = modalfrf(x,y,fs>window)` estimates a matrix of frequency response functions, `frf`, from the excitation signals, `x`, and the response signals, `y`, all sampled at a rate `fs`. The output, `frf`, is an H_1 estimate computed using Welch's method with `window` to window the signals. `x` and `y` must have the same number of rows. If `x` or `y` is a matrix, each column represents a signal. The frequency-response function matrix, `frf`, is computed in terms of dynamic flexibility, and the system response, `y`, contains acceleration measurements.

`frf = modalfrf(x,y,fs>window,noverlap)` specifies `noverlap` samples of overlap between adjoining segments.

`frf = modalfrf(____,Name,Value)` specifies options using name-value pair arguments, using any combination of inputs from previous syntaxes. Options include the estimator, the measurement configuration, and the type of sensor measuring the system response.

`[frf,f,coh] = modalfrf(____)` also returns the frequency vector corresponding to each frequency-response function, and the multiple coherence matrix.

`modalfrf(____)` with no output arguments plots the frequency response functions in the current figure. The plots are limited to the first four excitations and four responses.

Examples

Frequency-Response Function of Hammer Excitation

Visualize the frequency-response function of a single-input/single-output hammer excitation.

Load a data file that contains

- `Xhammer` -- An input excitation signal consisting of five hammer blows delivered periodically.
- `Yhammer` -- The response of a system to the input. `Yhammer` is measured as a displacement.

The signals are sampled at 4 kHz. Plot the excitation and output signals.

```
load modaldata

subplot(2,1,1)
plot(thammer,Xhammer(:))
ylabel('Force (N)')
subplot(2,1,2)
plot(thammer,Yhammer(:))
ylabel('Displacement (m)')
xlabel('Time (s)')
```

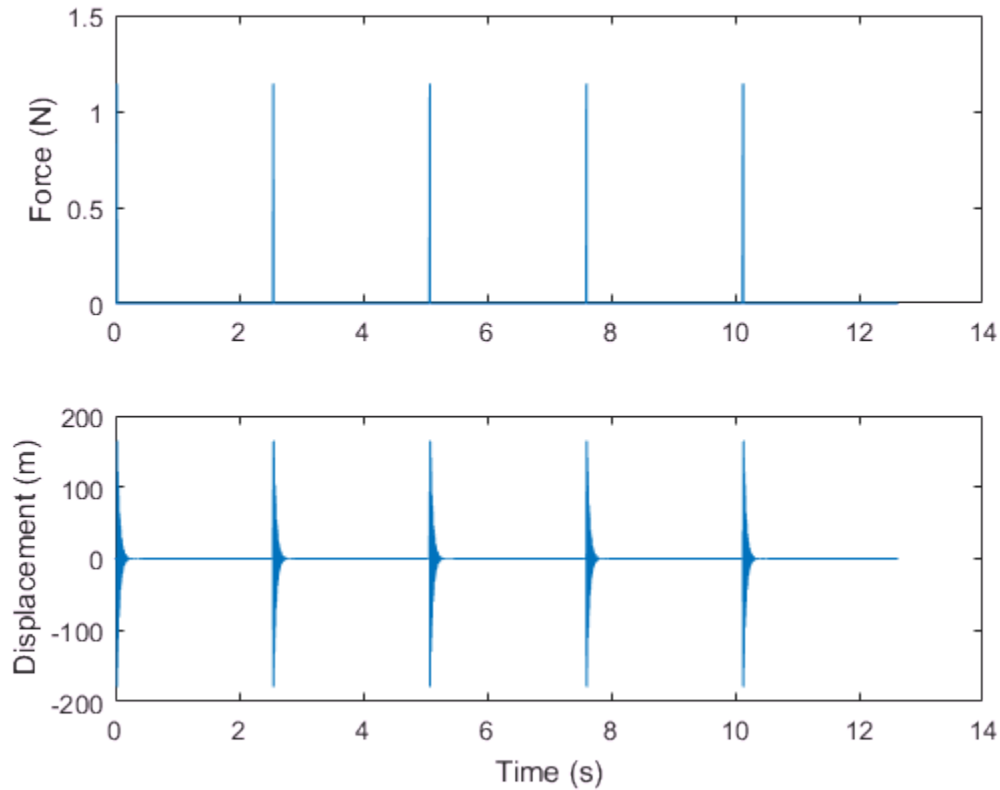

Compute and display the frequency-response function. Window the signals using a rectangular window. Specify that the window covers the period between hammer blows.

```
clf
winlen = size(Xhammer,1);
modalfrf(Xhammer(:),Yhammer(:),fs,winlen,'Sensor','dis')
```

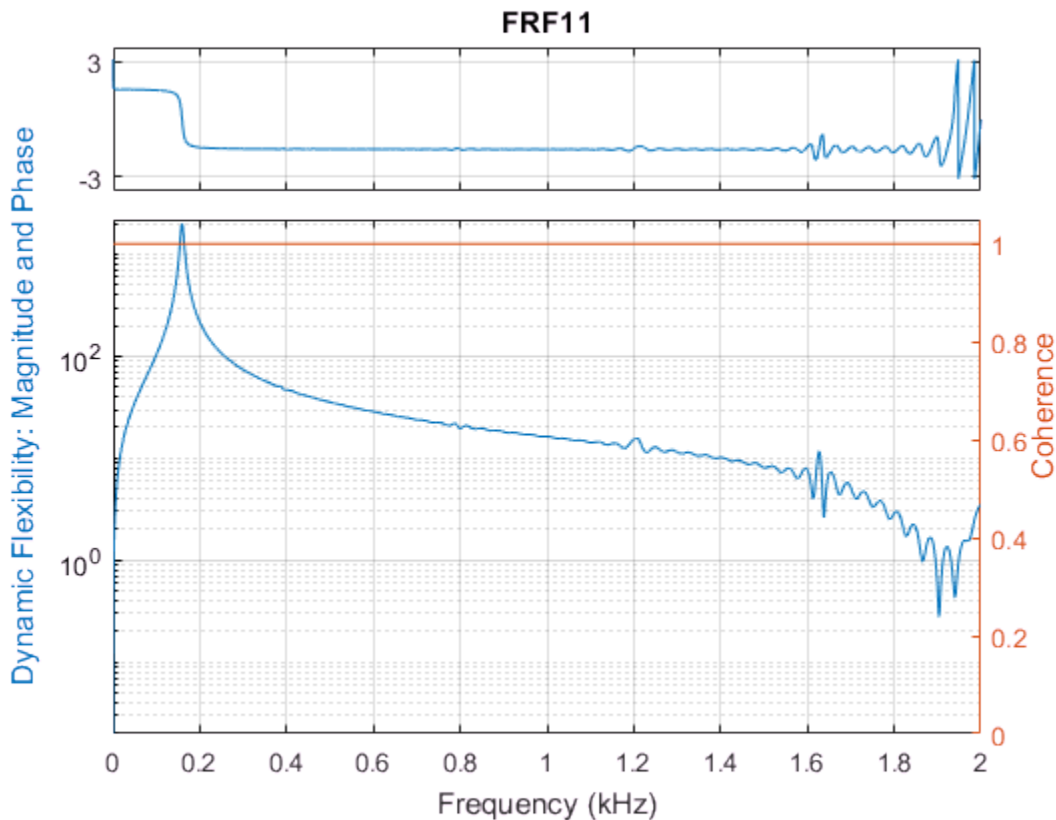

MIMO Frequency-Response Functions

Compute the frequency-response functions for a two-input/two-output system excited by random noise.

Load the data file. Compute the frequency-response functions using a 5000-sample Hann window and 50% overlap between adjoining data segments. Specify that the output measurements are displacements.

```
load modaldata
winlen = 5000;
```

```
[frf,f] = modalfrf(Xrand,Yrand,fs,hann(winlen),0.5*winlen,'Sensor','dis');
```

Use the plotting functionality of `modalfrf` to visualize the responses.

```
modalfrf(Xrand,Yrand,fs,hann(winlen),0.5*winlen,'Sensor','dis')
```

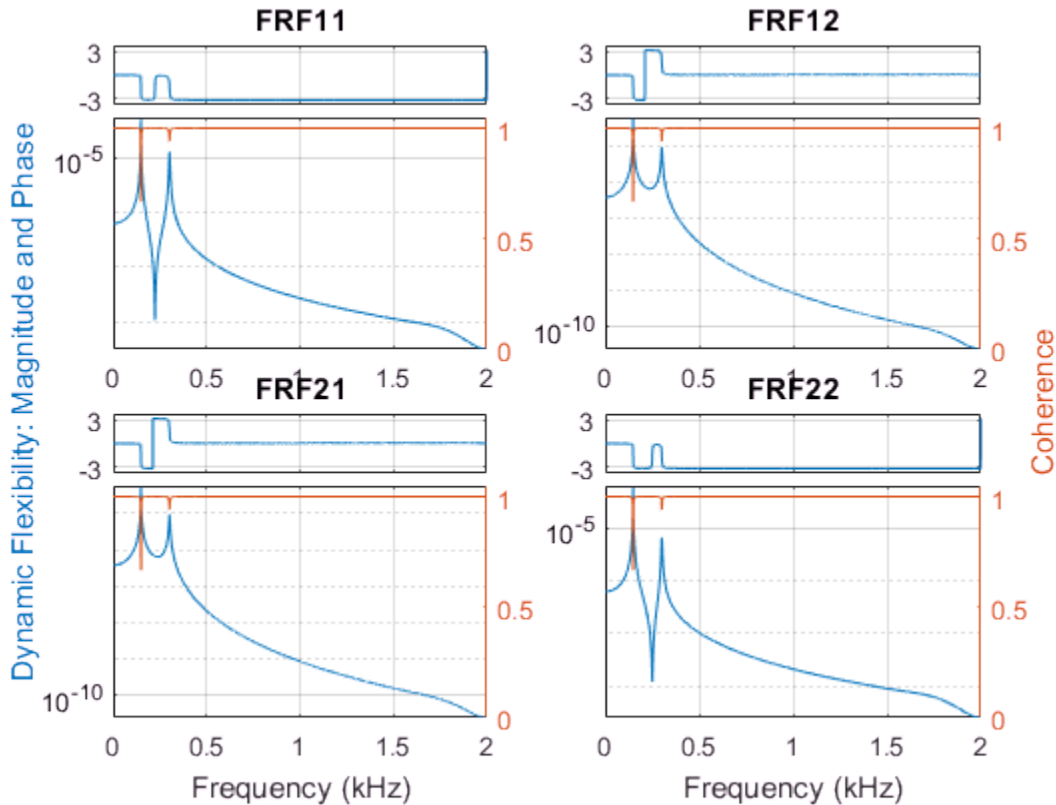

Frequency-Response Function of SISO System

Estimate the frequency-response function for a simple single-input/single-output system and compare it to the definition.

A one-dimensional discrete-time oscillating system consists of a unit mass, m , attached to a wall by a spring with unit elastic constant. A sensor samples the displacement of the

mass at $F_s = 1$ Hz. A damper impedes the motion of the mass by exerting on it a force proportional to speed, with damping constant $b = 0.01$.

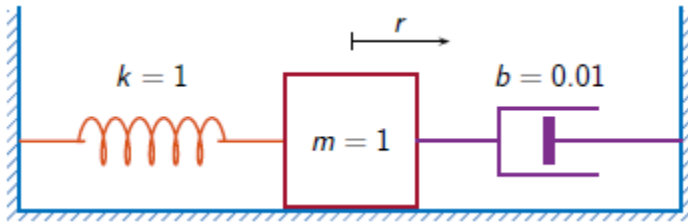

Generate 3000 time samples. Define the sampling interval $\Delta t = 1/F_s$.

```

Fs = 1;
dt = 1/Fs;
N = 3000;
t = dt*(0:N-1);
b = 0.01;

```

The system can be described by the state-space model

$$\begin{aligned} x(k+1) &= Ax(k) + Bu(k), \\ y(k) &= Cx(k) + Du(k), \end{aligned}$$

where $x = [r \ v]^T$ is the state vector, r and v are respectively the displacement and velocity of the mass, u is the driving force, and $y = r$ is the measured output. The state-space matrices are

$$A = \exp(A_c \Delta t), \quad B = A_c^{-1}(A - I)B_c, \quad C = [1 \ 0], \quad D = 0,$$

I is the 2×2 identity, and the continuous-time state-space matrices are

$$A_c = \begin{bmatrix} 0 & 1 \\ -1 & -b \end{bmatrix}, \quad B_c = \begin{bmatrix} 0 \\ 1 \end{bmatrix}.$$

```
Ac = [0 1; -1 -b];
```



```
A = expm(Ac*dt);  
  
Bc = [0;1];  
B = Ac\ (A-eye(2))*Bc;  
  
C = [1 0];  
D = 0;
```

The mass is driven by random input for the first 2000 seconds and then left to return to rest. Use the state-space model to compute the time evolution of the system starting from an all-zero initial state. Plot the displacement of the mass as a function of time.

```
rng default  
u = randn(1,N)/2;  
u(2001:end) = 0;  
  
y = 0;  
x = [0;0];  
for k = 1:N  
    y(k) = C*x + D*u(k);  
    x = A*x + B*u(k);  
end  
  
plot(t,y)
```

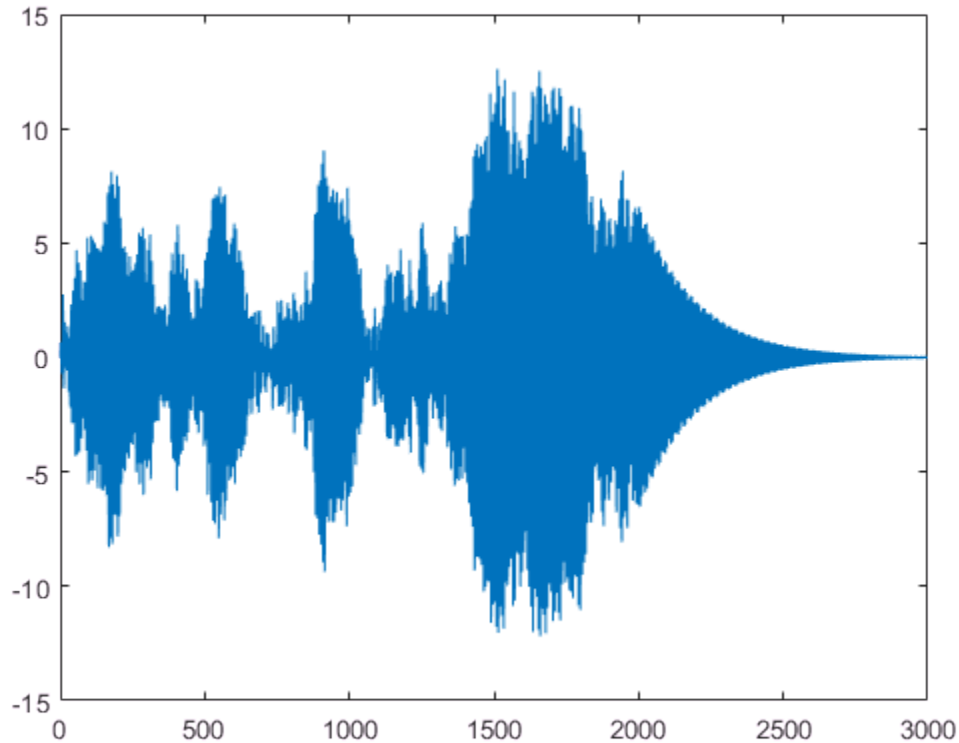

Estimate the modal frequency-response function of the system. Use a Hann window half as long as the measured signals. Specify that the output is the displacement of the mass.

```
wind = hann(N/2);
```

```
[frf,f] = modalfrf(u',y',Fs,wind,'Sensor','dis');
```

The frequency-response function of a discrete-time system can be expressed as the Z-transform of the time-domain transfer function of the system, evaluated at the unit circle. Compare the `modalfrf` estimate with the definition.

```
[b,a] = ss2tf(A,B,C,D);
```

```
nfs = 2048;
```

```

fz = 0:1/nfs:1/2-1/nfs;
z = exp(2j*pi*fz);
ztf = polyval(b,z)./polyval(a,z);

plot(f,20*log10(abs(frf)))
hold on
plot(fz*Fs,20*log10(abs(ztf)))
hold off
grid
ylim([-60 40])

```

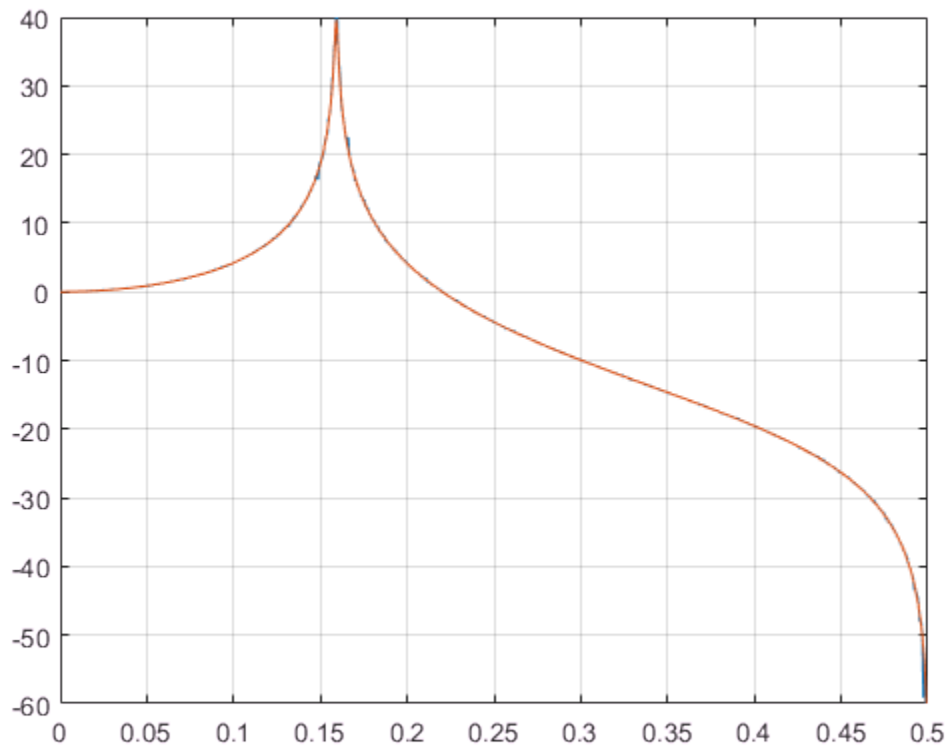

Estimate the natural frequency and the damping ratio for the vibration mode.

```
[fn,dr] = modalfit(frf,f,Fs,1,'FitMethod','PP')
```

$$f_n = 0.1593$$

$$d_r = 0.0043$$

Compare the natural frequency to $1/2\pi$, which is the theoretical value for the undamped system.

$$\text{theo} = 1/(2*\pi)$$

$$\text{theo} = 0.1592$$

Modal Parameters of Two-Body Oscillator

Estimate the frequency-response function and modal parameters of a simple multi-input/multi-output system.

An ideal one-dimensional oscillating system consists of two masses, m_1 and m_2 , confined between two walls. The units are such that $m_1 = 1$ and $m_2 = \mu$. Each mass is attached to the nearest wall by a spring with an elastic constant k . An identical spring connects the two masses. Three dampers impede the motion of the masses by exerting on them forces proportional to speed, with damping constant b . Sensors sample r_1 and r_2 , the displacements of the masses, at $F_s = 50$ Hz.

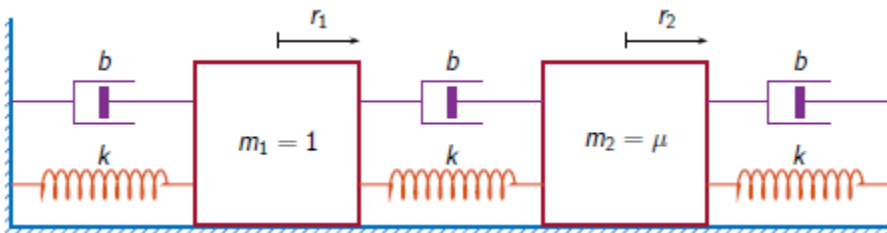

Generate 30000 time samples, equivalent to 600 seconds. Define the sampling interval $\Delta t = 1/F_s$.

$$F_s = 50;$$

```
dt = 1/Fs;
N = 30000;
t = dt*(0:N-1);
```

The system can be described by the state-space model

$$\begin{aligned}x(k+1) &= Ax(k) + Bu(k), \\y(k) &= Cx(k) + Du(k),\end{aligned}$$

where $x = [r_1 \ v_1 \ r_2 \ v_2]^T$ is the state vector, r_i and v_i are respectively the location and the velocity of the i -th mass, $u = [u_1 \ u_2]^T$ is the vector of input driving forces, and $y = [r_1 \ r_2]^T$ is the output vector. The state-space matrices are

$$A = \exp(A_c \Delta t), \quad B = A_c^{-1}(A - I)B_c, \quad C = \begin{bmatrix} 1 & 0 & 0 & 0 \\ 0 & 0 & 1 & 0 \end{bmatrix}, \quad D = \begin{bmatrix} 0 & 0 \\ 0 & 0 \end{bmatrix},$$

I is the 4×4 identity, and the continuous-time state-space matrices are

$$A_c = \begin{bmatrix} 0 & 1 & 0 & 0 \\ -2k & -2b & k & b \\ 0 & 0 & 0 & 1 \\ k/\mu & b/\mu & -2k/\mu & -2b/\mu \end{bmatrix}, \quad B_c = \begin{bmatrix} 0 & 0 \\ 1 & 0 \\ 0 & 0 \\ 0 & 1/\mu \end{bmatrix}.$$

Set $k = 400$, $b = 0.1$, and $\mu = 1/10$.

```
k = 400;
b = 0.1;
m = 1/10;
```

```
Ac = [0 1 0 0; -2*k -2*b k b; 0 0 0 1; k/m b/m -2*k/m -2*b/m];
A = expm(Ac*dt);
Bc = [0 0; 1 0; 0 0; 0 1/m];
B = Ac \ (A - eye(4)) * Bc;
C = [1 0 0 0; 0 0 1 0];
```

```
D = zeros(2);
```

The masses are driven by random input throughout the measurement. Use the state-space model to compute the time evolution of the system starting from an all-zero initial state.

```
rng default
u = randn(2,N);

y = [0;0];
x = [0;0;0;0];
for kk = 1:N
    y(:,kk) = C*x + D*u(:,kk);
    x = A*x + B*u(:,kk);
end
```

Use the input and output data to estimate the transfer function of the system as a function of frequency. Use a 5000-sample Hann window with 3000 samples of overlap between adjoining segments. Specify that the measured outputs are displacements.

```
wind = hann(15000);
nove = 9000;
[FRF,f] = modalfrf('u','y',Fs,wind,nove,'Sensor','dis');
```

Compute the theoretical transfer function as the Z-transform of the time-domain transfer function, evaluated at the unit circle.

```
nfs = 2048;
fz = 0:1/nfs:1/2-1/nfs;
z = exp(2j*pi*fz);

[b1,a1] = ss2tf(A,B,C,D,1);
[b2,a2] = ss2tf(A,B,C,D,2);

frf(1,:,1) = polyval(b1(1,:),z)./polyval(a1,z);
frf(1,:,2) = polyval(b1(2,:),z)./polyval(a1,z);
frf(2,:,1) = polyval(b2(1,:),z)./polyval(a2,z);
frf(2,:,2) = polyval(b2(2,:),z)./polyval(a2,z);
```

Plot the estimates and overlay the theoretical predictions.

```
for jk = 1:2
    for kj = 1:2
        subplot(2,2,2*(jk-1)+kj)
```

```

    plot(f,20*log10(abs(FRF(:,jk,kj))))
    hold on
    plot(fz*Fs,20*log10(abs(frf(jk,:,kj))))
    hold off
    axis([0 Fs/2 -100 0])
    title(sprintf('Input %d, Output %d',jk,kj))
end
end

```

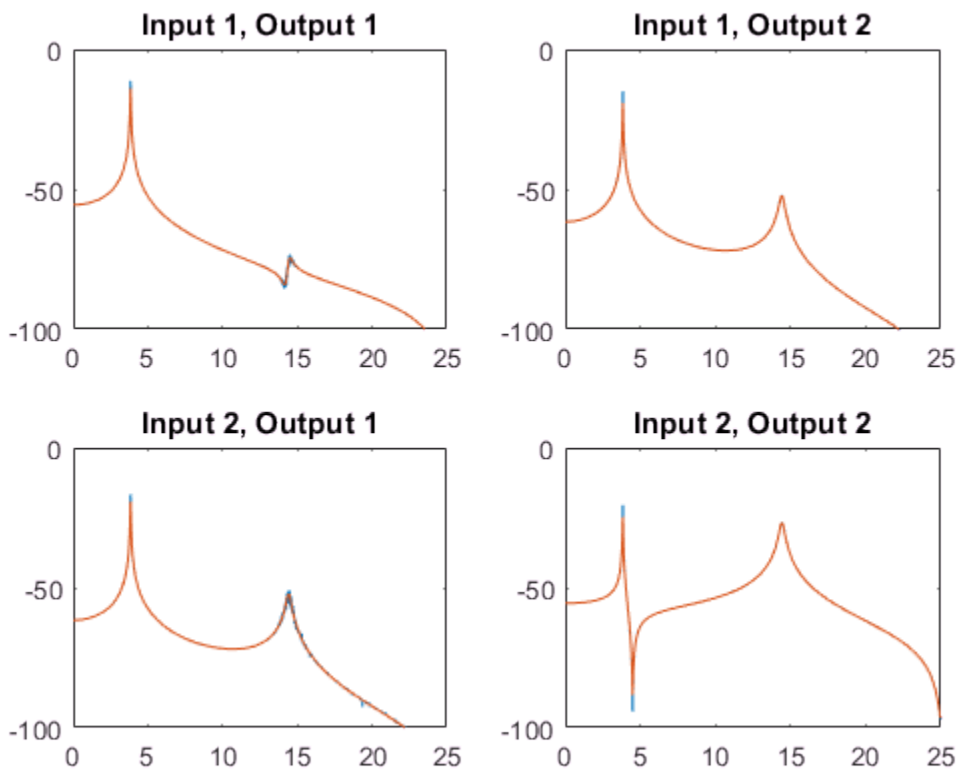

Plot the estimates using the built-in functionality of `modalfrf`.

```

figure
modalfrf(u',y',Fs,wind,nove,'Sensor','dis')

```

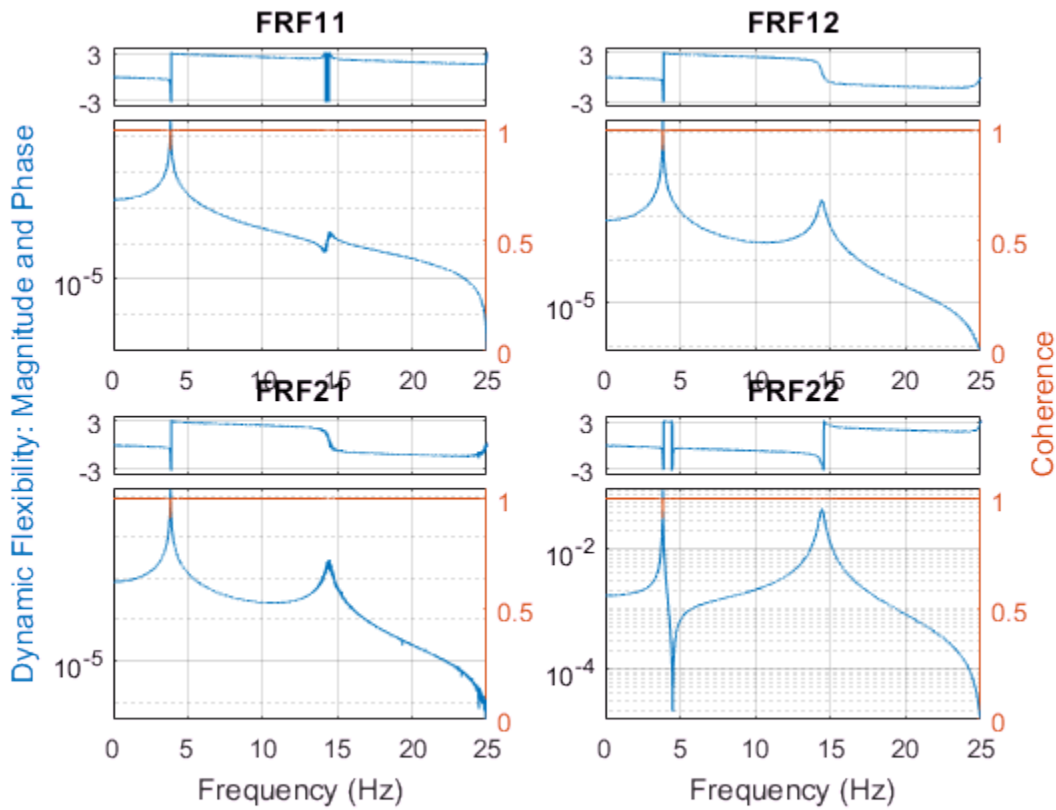

Estimate the natural frequencies, damping ratios, and mode shapes of the system. Use the peak-picking method for the calculation.

```
[fn,dr,ms] = modalfit(FRF,f,Fs,2,'FitMethod','pp');
fn
```

fn =

(:,: ,1) =

3.8466	3.8466
3.8495	3.8495

```
(:,:,2) =
    3.8492    3.8490
    3.8552   14.4684
```

Compare the natural frequencies to the theoretical predictions for the undamped system.

```
undamped = sqrt(eig([2*k -k; -k/m 2*k/m]))/2/pi
undamped =
    3.8470
   14.4259
```

Input Arguments

x — Excitation signals

vector | matrix

Excitation signals, specified as a vector or matrix.

Data Types: `single` | `double`

y — Response signals

vector | matrix

Response signals, specified as a vector or matrix.

Data Types: `single` | `double`

fs — Sample rate

positive scalar

Sample rate, specified as a positive scalar expressed in hertz.

window — Window

integer | vector

Window, specified as an integer or as a row or column vector. Use `window` to divide the signal into segments:

- If `window` is an integer, then `modalfrf` divides `x` and `y` into segments of length `window` and windows each segment with a rectangular window of that length.
- If `window` is a vector, then `modalfrf` divides `x` and `y` into segments of the same length as the vector and windows each segment using `window`.

If the length of `x` and `y` cannot be divided exactly into an integer number of segments with `noverlap` overlapping samples, then the signals are truncated accordingly.

For a list of available windows, see “Windows”.

Example: `hann(N+1)` and `(1 - cos(2*pi*(0:N)'/N))/2` both specify a Hann window of length `N + 1`.

Data Types: `single` | `double`

noverlap — Number of overlapped samples

0 (default) | positive integer

Number of overlapped samples, specified as a positive integer.

- If `window` is scalar, then `noverlap` must be smaller than `window`.
- If `window` is a vector, then `noverlap` must be smaller than the length of `window`.

Data Types: `double` | `single`

Name-Value Pair Arguments

Specify optional comma-separated pairs of `Name`, `Value` arguments. `Name` is the argument name and `Value` is the corresponding value. `Name` must appear inside single quotes (' '). You can specify several name and value pair arguments in any order as `Name1, Value1, ..., NameN, ValueN`.

Example: `'Sensor', 'vel', 'Est', 'H1'` specifies that the response signal consists of velocity measurements and that the estimator of choice is `H1`.

'Estimator' — Estimator

'H1' (default) | 'H2' | 'Hv'

Estimator, specified as the comma-separated pair consisting of `'Estimator'` and `'H1'`, `'H2'`, or `'Hv'`. See “Transfer Function” on page 1-2389 for more information about the H_1 and H_2 estimators.

- Use `'H1'` when the noise is uncorrelated with the excitation signals.

- Use 'H2' when the noise is uncorrelated with the response signals. In this case, the number of excitation signals must equal the number of response signals.
- Use 'HV' to minimize the discrepancy between modeled and estimated response data by minimizing the trace of the error matrix. H_v is the geometric mean of H_1 and H_2 :

$$H_v = (H_1 H_2)^{1/2}$$

The measurement must be SISO.

Data Types: char

'Measurement' — Measurement configuration for equal numbers of excitation and response channels

'fixed' (default) | 'rovinginput' | 'rovingoutput'

Measurement configuration for equal numbers of excitation and response channels, specified as the comma-separated pair consisting of 'Measurement' and 'fixed', 'rovinginput', or 'rovingoutput'.

- Use 'fixed' when there are excitation sources and sensors at fixed locations of the system. Each excitation contributes to every response.
- Use 'rovinginput' when the measurements result from a roving excitation (or *roving hammer*) test. A single sensor is kept at a fixed location of the system. A single excitation source is placed at multiple locations and produces one sensor response per location. The function output $\text{frf}(:, :, i) = \text{modalfrf}(x(:, i), y(:, i))$.
- Use 'rovingoutput' when the measurements result from a *roving sensor* test. A single excitation source is kept at a fixed location of the system. A single sensor is placed at multiple locations and responds to one excitation per location. The function output $\text{frf}(:, i) = \text{modalfrf}(x(:, i), y(:, i))$.

Data Types: char

'Sensor' — Sensor type

'acc' (default) | 'dis' | 'vel'

Sensor type, specified as the comma-separated pair consisting of 'Sensor' and 'acc', 'dis', or 'vel'.

- 'acc' — Specifies that the response signal voltage is proportional to acceleration.
- 'dis' — Specifies that the response signal voltage is proportional to displacement.
- 'vel' — Specifies that the response signal voltage is proportional to velocity.

Data Types: char

Output Arguments

frf — Frequency-response functions

vector | matrix | 3-D array

Frequency-response functions, returned as a vector, matrix, or 3-D array. `frf` has size p -by- m -by- n , where p is the number of frequency bins, m is the number of responses, and n is the number of excitation signals.

f — Frequencies

vector

Frequencies, returned as a vector.

coh — Multiple coherence matrix

matrix

Multiple coherence matrix, returned as a matrix. `coh` has one column for each response signal.

References

- [1] Brandt, Anders. *Noise and Vibration Analysis: Signal Analysis and Experimental Procedures*. Chichester, UK: John Wiley & Sons, 2011.
- [2] Vold, Håvard, John Crowley, and G. Thomas Rocklin. “New Ways of Estimating Frequency Response Functions.” *Sound and Vibration*. Vol. 18, November 1984, pp.34–38.

See Also

See Also

`modalfit` | `modalsd` | `tfestimate`

Introduced in R2017a

modalsd

Generate stabilization diagram for modal analysis

Syntax

```
modalsd(frf, f, fs)
modalsd(frf, f, fs, Name, Value)
```

```
fn = modalsd( ___ )
```

Description

`modalsd(frf, f, fs)` generates a stabilization diagram in the current figure. `modalsd` estimates the natural frequencies and damping ratios from one to 50 modes and generates the diagram using the least-squares complex exponential (LSCE) algorithm. `fs` is the sample rate. The frequency, `f`, is a vector having a number of elements equal to the number of rows of the frequency-response function, `frf`. You can use this diagram to differentiate between computational and physical modes.

`modalsd(frf, f, fs, Name, Value)` specifies options using name-value pair arguments.

`fn = modalsd(___)` returns a cell array of natural frequencies, `fn`, identified as being stable between consecutive model orders. The *i*th element contains a length-*i* vector containing natural frequencies of stable poles. Poles that are not stable are returned as NaNs. This syntax accepts any combination of inputs from previous syntaxes.

Examples

MIMO Stabilization Diagram

Compute the frequency-response functions for a two-input/two-output system excited by random noise.

Load the data file. Compute the frequency-response functions using a 5000-sample Hann window and 50% overlap between adjoining data segments. Specify that the output measurements are displacements.

```
load modaldata
winlen = 5000;

[frf,f] = modalfrf(Xrand,Yrand,fs,hann(winlen),0.5*winlen,'Sensor','dis');
```

Generate a stabilization diagram to identify up to 20 physical modes.

```
modalsd(frf,f,fs,'MaxModes',20)
```

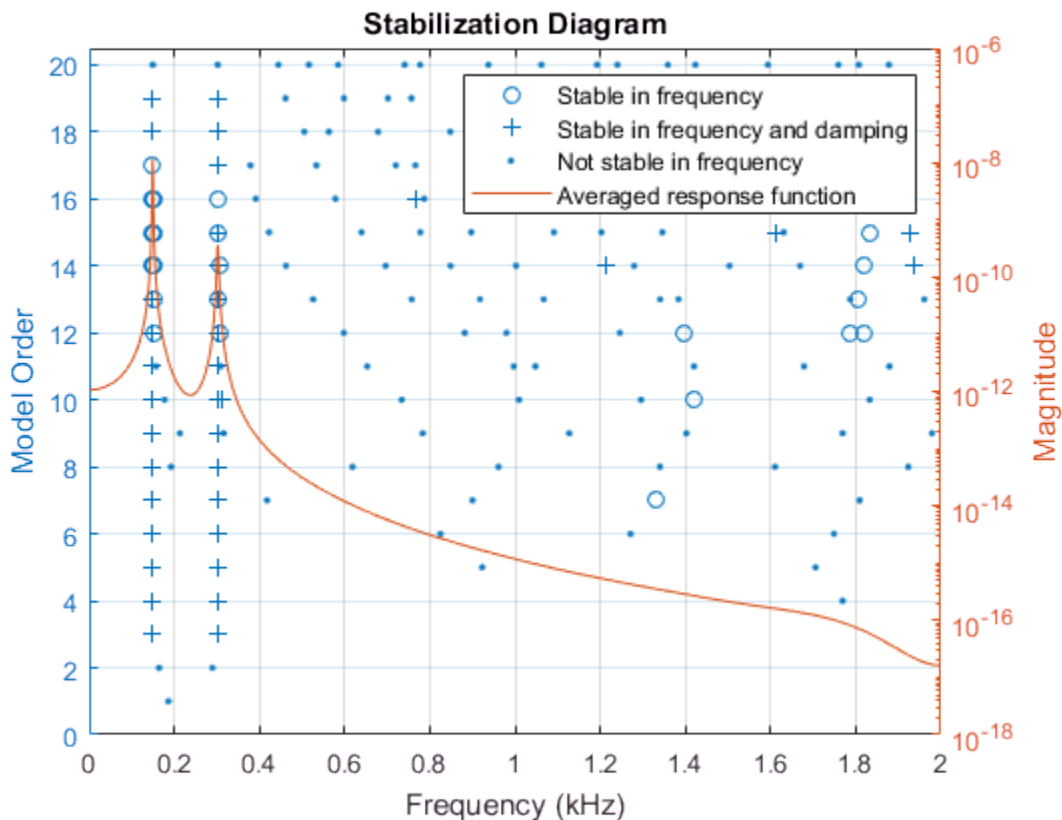

Repeat the computation, but now tighten the criteria for stability. Classify a given pole as stable in frequency if its natural frequency changes by less than 0.01% as the model order increases. Classify a given pole as stable in damping if the damping ratio estimate changes by less than 0.2% as the model order increases.

```
modalsd(frf,f,fs,'MaxModes',20,'SCriteria',[1e-4 0.002])
```

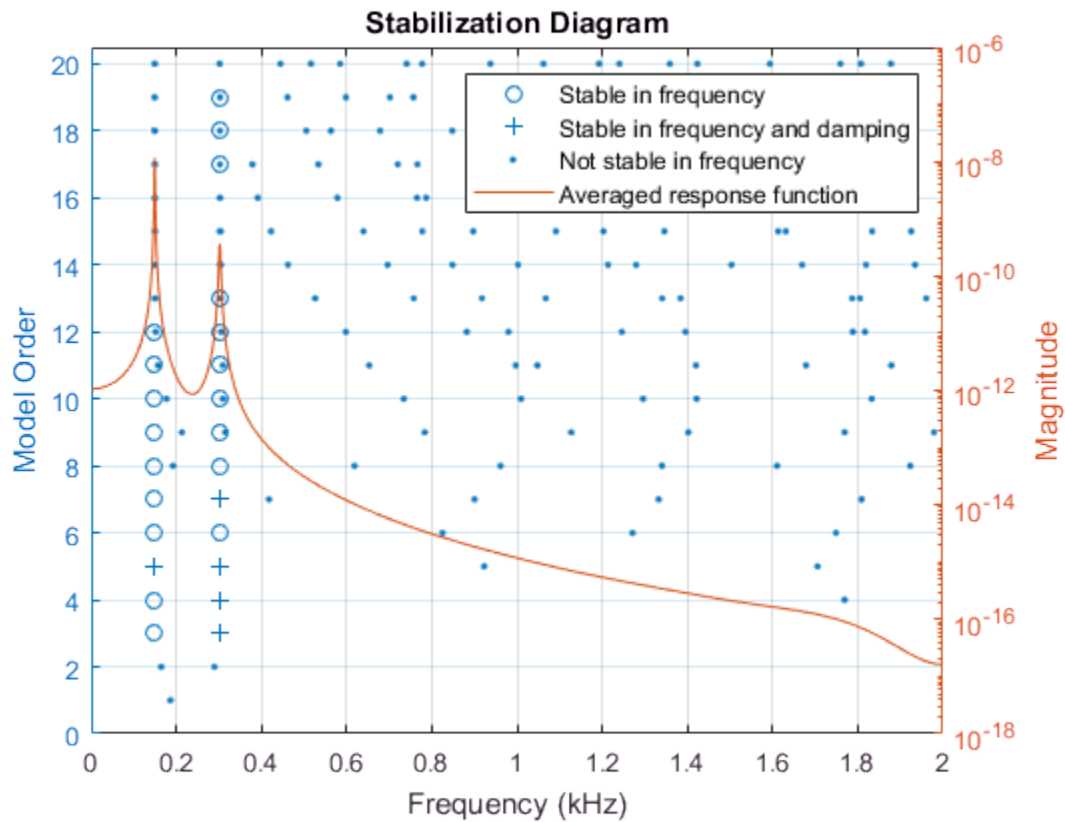

Restrict the frequency range to between 0 and 500 Hz. Relax the stability criteria to 0.5% for frequency and 10% for damping.

```
modalsd(frf,f,fs,'MaxModes',20,'SCriteria',[5e-3 0.1],'FreqRange',[0 500])
```

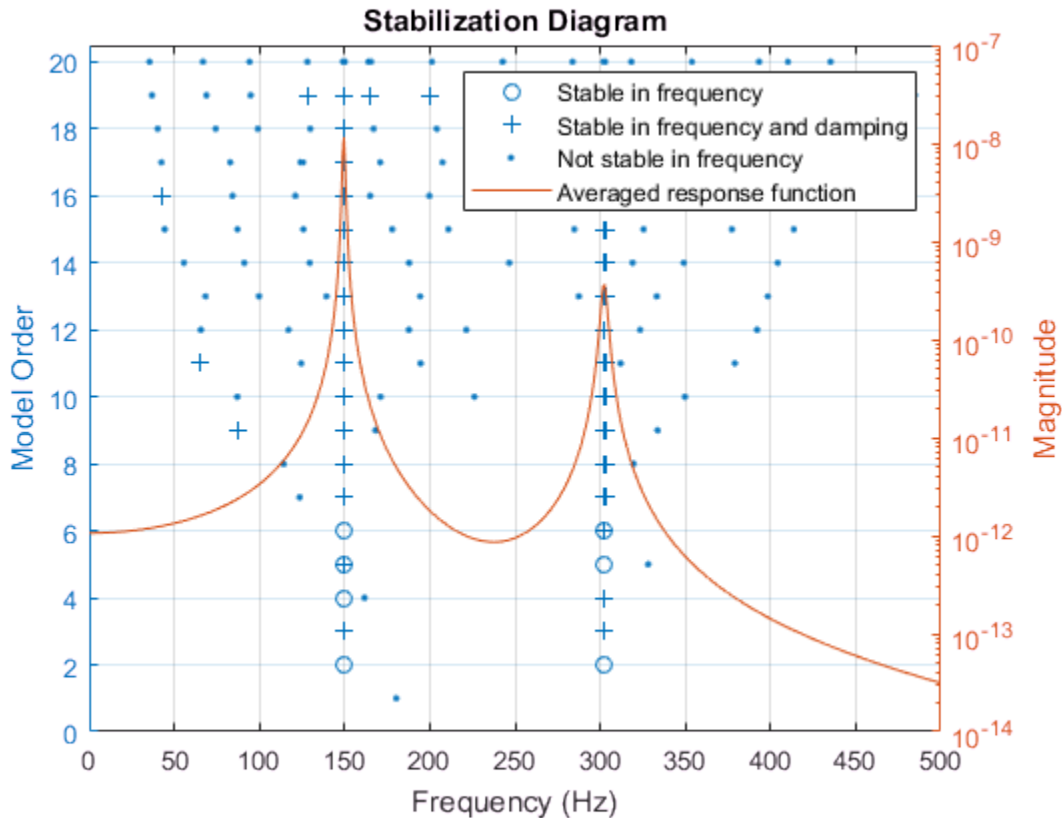

Input Arguments

frf — Frequency-response functions

vector | matrix | 3-D array

Frequency-response functions, specified as a vector, matrix, or 3-D array. `frf` has size p -by- m -by- n , where p is the number of frequency bins, m is the number of response signals, and n is the number of excitation signals used to estimate the transfer function.

Example:

```
tffestimate(randn(1,1000),sin(2*pi*(1:1000)/4)+randn(1,1000)/10)
```

approximates the frequency response of an oscillator.

Data Types: `single` | `double`
Complex Number Support: Yes

f — Frequencies

vector

Frequencies, specified as a vector. The number of elements of `f` must equal the number of rows of `frf`.

Data Types: `single` | `double`

fs — Sample rate of measurement data

positive scalar

Sample rate of measurement data, specified as a positive scalar expressed in hertz.

Data Types: `single` | `double`

Name-Value Pair Arguments

Specify optional comma-separated pairs of `Name`, `Value` arguments. `Name` is the argument name and `Value` is the corresponding value. `Name` must appear inside single quotes (' '). You can specify several name and value pair arguments in any order as `Name1`, `Value1`, ..., `NameN`, `ValueN`.

Example: `'MaxModes',20,'FreqRange',[0 500]` computes up to 20 physical modes and restricts the frequency range to between 0 and 500 Hz.

'MaxModes' — Maximum number of modes

50 (default) | positive integer

Maximum number of modes, specified as the comma-separated pair consisting of `'MaxModes'` and a positive integer.

Data Types: `single` | `double`

'FreqRange' — Frequency range

positive two-element vector

Frequency range, specified as the comma-separated pair consisting of `'FreqRange'` and a positive two-element vector of increasing values contained within the range specified in `f`.

Data Types: `single` | `double`

'SCriteria' — Criteria to define stable natural frequencies and damping ratios between consecutive model degrees of freedom

[0.01 0.05] (default) | positive two-element vector

Criteria to define stable natural frequencies and damping ratios between consecutive model degrees of freedom, specified as the comma-separated pair consisting of 'SCriteria' and a positive two-element vector. 'SCriteria' contains the maximum fractional differences between poles to be classified as stable. The first element of the vector applies to natural frequencies. The second element applies to damping ratios.

Data Types: single | double

Output Arguments

fn — Natural frequencies identified as stable

matrix

Natural frequencies identified as stable, returned as a matrix. The first i elements of the i th row contain natural frequencies. Poles that are nonphysical or not stable in frequency are returned as NaNs.

References

- [1] Brandt, Anders. *Noise and Vibration Analysis: Signal Analysis and Experimental Procedures*. Chichester, UK: John Wiley & Sons, 2011.
- [2] Vold, Håvard, John Crowley, and G. Thomas Rocklin. “New Ways of Estimating Frequency Response Functions.” *Sound and Vibration*. Vol. 18, November 1984, pp.34–38.

See Also

See Also

modalfit | modalfrf

Introduced in R2017a

modulate

Modulation for communications simulation

Syntax

```
y = modulate(x,fc,fs,'method')
y = modulate(x,fc,fs,'method',opt)
[y,t] = modulate(x,fc,fs)
```

Description

`y = modulate(x,fc,fs,'method')` and

`y = modulate(x,fc,fs,'method',opt)` modulate the real message signal `x` with a carrier frequency `fc` and sampling frequency `fs`, using one of the options listed below for `'method'`. Note that some methods accept an option, `opt`.

Note: Use `modulate` and `demod` in the Signal Processing Toolbox with real-valued signals to obtain real-valued outputs. `modulate` and `demod` are not intended to accept complex-valued inputs or produce complex-valued outputs.

Method	Description
amdsb-sc or am	Amplitude modulation, double sideband, suppressed carrier. Multiplies <code>x</code> by a sinusoid of frequency <code>fc</code> . $y = x \cdot \cos(2\pi \cdot fc \cdot t)$
amdsb-tc	Amplitude modulation, double sideband, transmitted carrier. Subtracts scalar <code>opt</code> from <code>x</code> and multiplies the result by a sinusoid of frequency <code>fc</code> . $y = (x - opt) \cdot \cos(2\pi \cdot fc \cdot t)$

Method	Description
	If the <code>opt</code> parameter is not present, <code>modulate</code> uses a default of <code>min(min(x))</code> so that the message signal (<code>x-opt</code>) is entirely nonnegative and has a minimum value of 0.
<code>amssb</code>	Amplitude modulation, single sideband. Multiplies <code>x</code> by a sinusoid of frequency <code>fc</code> and adds the result to the Hilbert transform of <code>x</code> multiplied by a phase shifted sinusoid of frequency <code>fc</code> . $y = x \cdot \cos(2\pi \cdot fc \cdot t) + \text{imag}(\text{hilbert}(x)) \cdot \sin(2\pi \cdot fc \cdot t)$ This effectively removes the upper sideband.
<code>fm</code>	Frequency modulation. Creates a sinusoid with instantaneous frequency that varies with the message signal <code>x</code> . $y = \cos(2\pi \cdot fc \cdot t + \text{opt} \cdot \text{cumsum}(x))$ <code>cumsum</code> is a rectangular approximation to the integral of <code>x</code> . <code>modulate</code> uses <code>opt</code> as the constant of frequency modulation. If <code>opt</code> is not present, <code>modulate</code> uses a default of $\text{opt} = (fc/fs) \cdot 2\pi / (\max(\max(x)))$ so the maximum frequency excursion from <code>fc</code> is <code>fc</code> Hz.
<code>pm</code>	Phase modulation. Creates a sinusoid of frequency <code>fc</code> whose phase varies with the message signal <code>x</code> . $y = \cos(2\pi \cdot fc \cdot t + \text{opt} \cdot x)$ <code>modulate</code> uses <code>opt</code> as the constant of phase modulation. If <code>opt</code> is not present, <code>modulate</code> uses a default of $\text{opt} = \pi / (\max(\max(x)))$ so the maximum phase excursion is π radians.

Method	Description
pwm	<p>Pulse-width modulation. Creates a pulse-width modulated signal from the pulse widths in x. The elements of x must be between 0 and 1, specifying the width of each pulse in fractions of a period. The pulses start at the beginning of each period, that is, they are left justified.</p> <p><code>modulate(x,fc,fs,'pwm','centered')</code></p> <p>yields pulses centered at the beginning of each period. y is length <code>length(x)*fs/fc</code>.</p>
ppm	<p>Pulse-position modulation. Creates a pulse-position modulated signal from the pulse positions in x. The elements of x must be between 0 and 1, specifying the left edge of each pulse in fractions of a period. <code>opt</code> is a scalar between 0 and 1 that specifies the length of each pulse in fractions of a period. The default for <code>opt</code> is 0.1. y is length <code>length(x)*fs/fc</code>.</p>
qam	<p>Quadrature amplitude modulation. Creates a quadrature amplitude modulated signal from signals x and <code>opt</code>.</p> <p>$y = x.\cos(2\pi\text{fc}t) + \text{opt}.\sin(2\pi\text{fc}t)$</p> <p><code>opt</code> must be the same size as x.</p>

If you do not specify '*method*', then `modulate` assumes `am`. Except for the `pwm` and `ppm` cases, y is the same size as x .

If x is an array, `modulate` modulates its columns.

`[y,t] = modulate(x,fc,fs)` returns the internal time vector t that `modulate` uses in its computations.

Examples

Frequency and Single-Sideband Amplitude Modulation

Generate a 10 Hz sinusoidal signal sampled at a rate of 200 Hz for 1 second. Embed the sinusoid in white Gaussian noise of variance 0.01.

```
fs = 200;
t = 0:1/fs:1;
x = sin(2*pi*10*t)+randn(size(t))/10;
```

Frequency modulate the signal with a carrier frequency of 50 Hz. Compute the Welch power spectral density estimates of the original and modulated sequences. Use a 100-sample Hamming window with 80 samples of overlap. Specify an FFT length of 1024.

```
y = modulate(x,50,fs);
```

```
pwelch([x;y]',hamming(100),80,1024,fs,'centered')
```

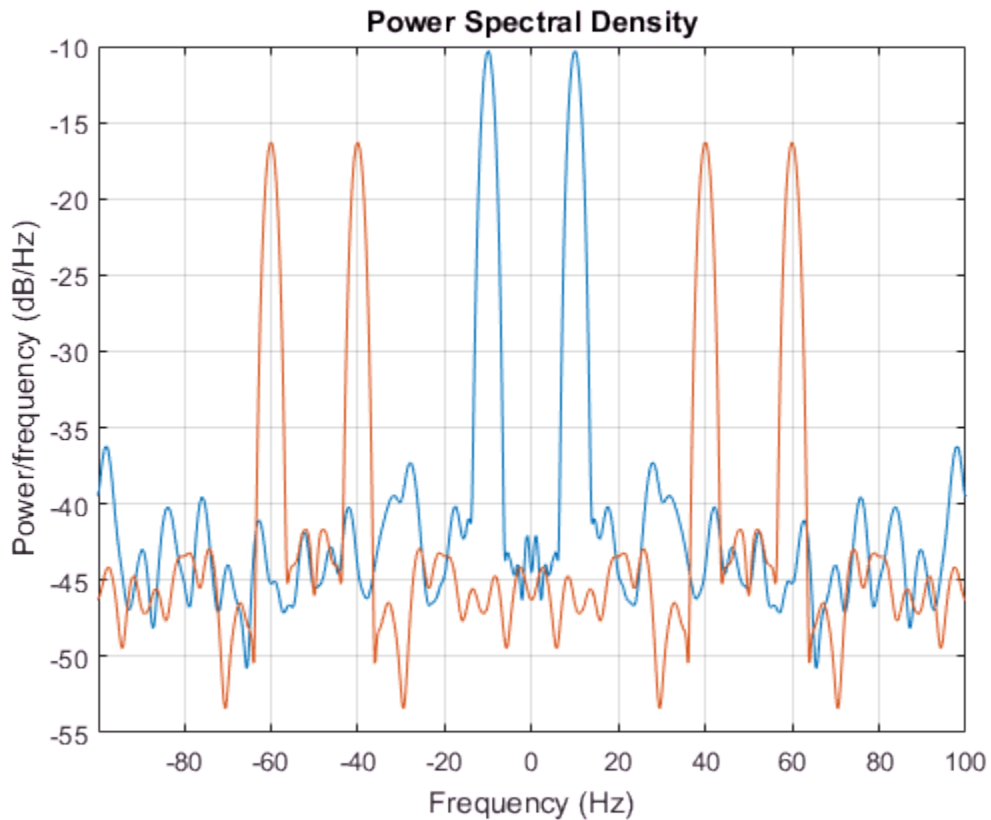

Single-sideband amplitude modulate the signal with the same carrier frequency. Compute and display the new Welch PSD estimates.

```
y = modulate(x,50,fs, 'amssb');  
pwelch([x;y]',hamming(100),80,1024,fs, 'centered')
```

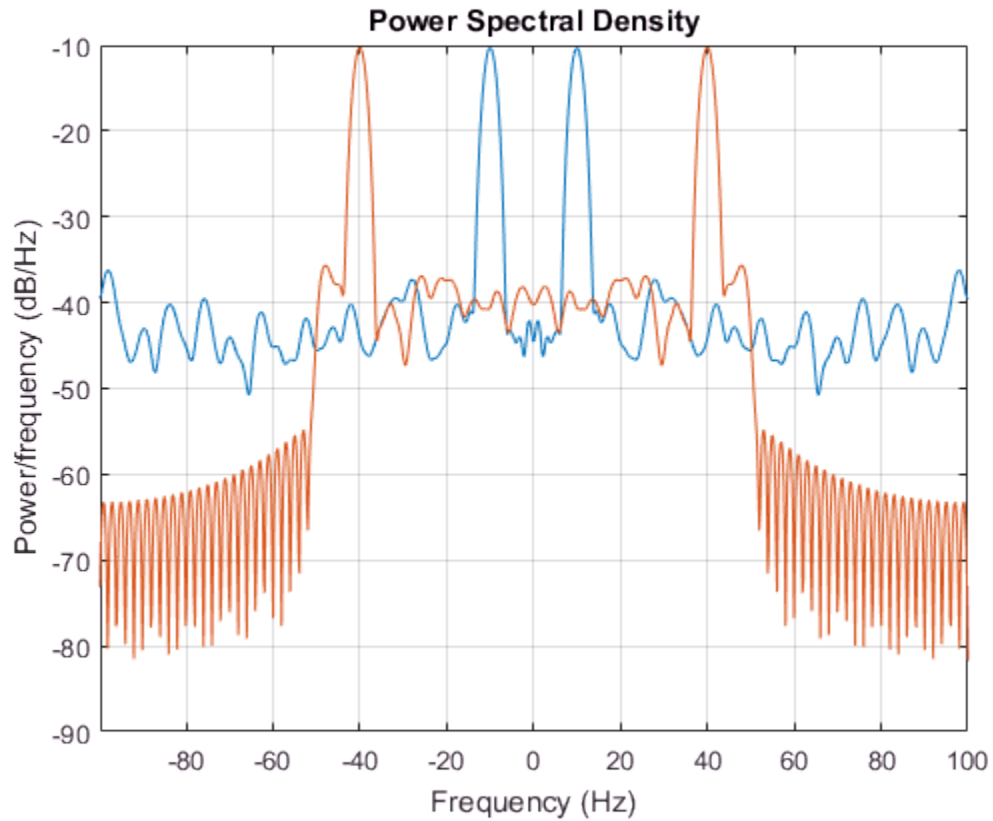

See Also

demod | vco

Introduced before R2006a

mscohere

Magnitude-squared coherence

Syntax

```
cxy = mscohere(x,y)
```

```
cxy = mscohere(x,y>window)
```

```
cxy = mscohere(x,y>window,noverlap)
```

```
cxy = mscohere(x,y>window,noverlap,nfft)
```

```
cxy = mscohere( ____, 'mimo' )
```

```
[cxy,w] = mscohere( ____ )
```

```
[cxy,f] = mscohere( ____, fs)
```

```
[cxy,w] = mscohere(x,y>window,noverlap,w)
```

```
[cxy,f] = mscohere(x,y>window,noverlap,f,fs)
```

```
[ ____ ] = mscohere(x,y, ____, freqrange)
```

```
mscohere( ____ )
```

Description

`cxy = mscohere(x,y)` finds the magnitude-squared coherence estimate, `cxy`, of the input signals, `x` and `y`.

- If `x` and `y` are both vectors, they must have the same length.
- If one of the signals is a matrix and the other is a vector, then the length of the vector must equal the number of rows in the matrix. The function expands the vector and returns a matrix of column-by-column magnitude-squared coherence estimates.
- If `x` and `y` are matrices with the same number of rows but different numbers of columns, then `mscohere` returns a multiple coherence matrix. The m th column of `cxy` contains an estimate of the degree of correlation between all the input signals and

the *m*th output signal. See “Magnitude-Squared Coherence” on page 1-1342 for more information.

- If *x* and *y* are matrices of equal size, then `mscohere` operates column-wise: `cxy(:,n) = mscohere(x(:,n),y(:,n))`. To obtain a multiple coherence matrix, append `'mimo'` to the argument list.

`cxy = mscohere(x,y>window)` uses `window` to divide *x* and *y* into segments and perform windowing. You must use at least two segments. Otherwise, the magnitude-squared coherence is 1 for all frequencies. In the MIMO case, the number of segments must be greater than the number of input channels.

`cxy = mscohere(x,y>window,noverlap)` uses `noverlap` samples of overlap between adjoining segments.

`cxy = mscohere(x,y>window,noverlap,nfft)` uses `nfft` sampling points to calculate the discrete Fourier transform.

`cxy = mscohere(____,'mimo')` computes a multiple coherence matrix for matrix inputs. This syntax can include any combination of input arguments from previous syntaxes.

`[cxy,w] = mscohere(____)` returns a vector of normalized frequencies, *w*, at which the magnitude-squared coherence is estimated.

`[cxy,f] = mscohere(____,fs)` returns a vector of frequencies, *f*, expressed in terms of the sample rate, *fs*, at which the magnitude-squared coherence is estimated. *fs* must be the sixth numeric input to `mscohere`. To input a sample rate and still use the default values of the preceding optional arguments, specify these arguments as empty, `[]`.

`[cxy,w] = mscohere(x,y>window,noverlap,w)` returns the magnitude-squared coherence estimate at the normalized frequencies specified in *w*.

`[cxy,f] = mscohere(x,y>window,noverlap,f,fs)` returns the magnitude-squared coherence estimate at the frequencies specified in *f*.

`[____] = mscohere(x,y,____,freqrange)` returns the magnitude-squared coherence estimate over the frequency range specified by `freqrange`. Valid options for `freqrange` are `'onesided'`, `'twosided'`, and `'centered'`.

`mscohere(____)` with no output arguments plots the magnitude-squared coherence estimate in the current figure window.

Examples

Coherence Estimate of Two Sequences

Compute and plot the coherence estimate between two colored noise sequences.

Generate a signal consisting of white Gaussian noise.

```
r = randn(16384,1);
```

To create the first sequence, bandpass filter the signal. Design a 16th-order filter that passes normalized frequencies between 0.2π and 0.4π rad/sample. Specify a stopband attenuation of 60 dB. Filter the original signal.

```
dx = designfilt('bandpassiir','FilterOrder',16, ...  
    'StopbandFrequency1',0.2,'StopbandFrequency2',0.4, ...  
    'StopbandAttenuation',60);  
x = filter(dx,r);
```

To create the second sequence, design a 16th-order filter that stops normalized frequencies between 0.6π and 0.8π rad/sample. Specify a passband ripple of 0.1 dB. Filter the original signal.

```
dy = designfilt('bandstopiir','FilterOrder',16, ...  
    'PassbandFrequency1',0.6,'PassbandFrequency2',0.8, ...  
    'PassbandRipple',0.1);  
y = filter(dy,r);
```

Estimate the magnitude-squared coherence of x and y . Use a 512-sample Hamming window. Specify 500 samples of overlap between adjoining segments and 2048 DFT points.

```
[cxy,fc] = mscohere(x,y,hamming(512),500,2048);
```

Plot the coherence function and overlay the frequency responses of the filters.

```
[qx,f] = freqz(dx);  
qy = freqz(dy);  
  
plot(fc/pi,cxy)  
hold on  
plot(f/pi,abs(qx),f/pi,abs(qy))  
hold off
```

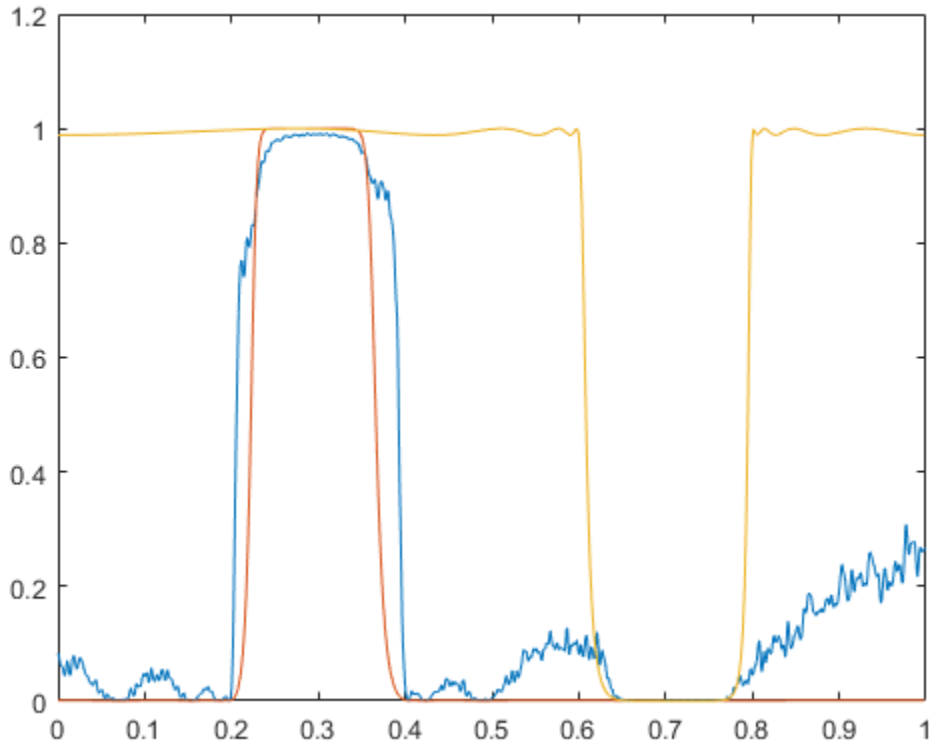

Multiple Coherence and Ordinary Coherence

Generate a random two-channel signal, x . Generate another signal, y , by lowpass filtering the two channels and adding them together. Specify a 30th-order FIR filter with a cutoff frequency of 0.3π and designed using a rectangular window.

```
h = fir1(30,0.3,rectwin(31));
x = randn(16384,2);
y = sum(filter(h,1,x),2);
```

Compute the multiple-coherence estimate of x and y . Window the signals with a 1024-sample Hann window. Specify 512 samples of overlap between adjoining segments and 1042 DFT points. Plot the estimate.

```
noverlap = 512;
nfft = 1024;

mscohere(x,y,hann(nfft),noverlap,nfft,'mimo')
```

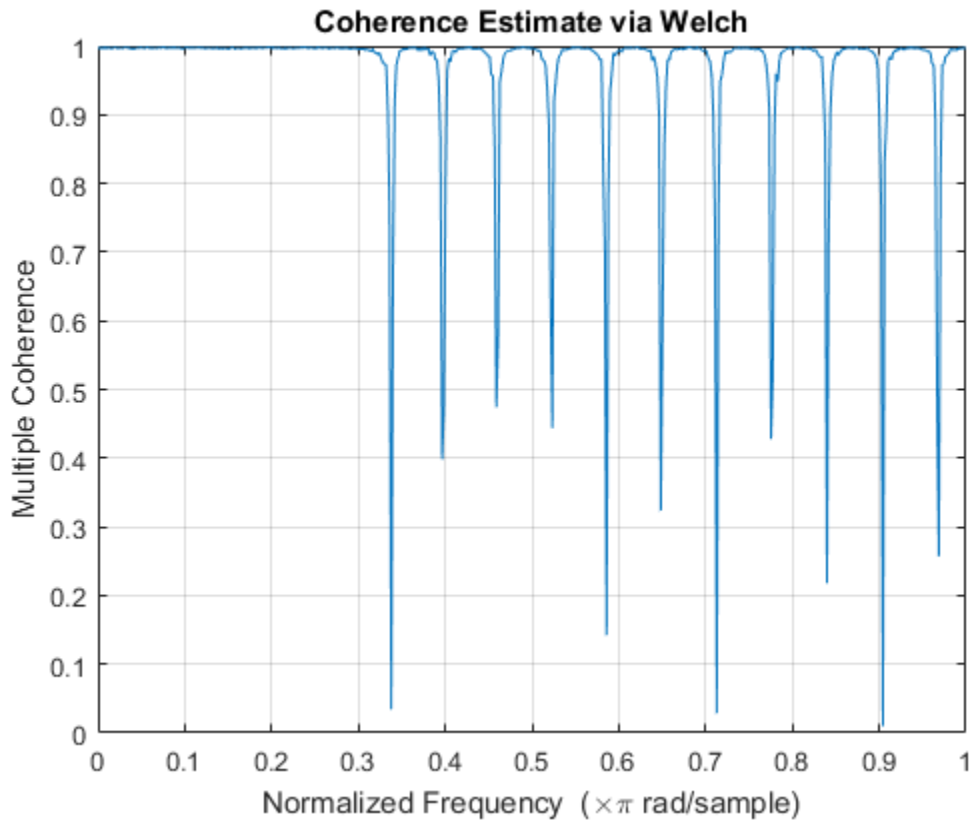

Compare the coherence estimate to the frequency response of the filter. The drops in coherence correspond to the zeros of the frequency response.

```
[H,f] = freqz(h);

hold on
yyaxis right
plot(f/pi,20*log10(abs(H)))
hold off
```

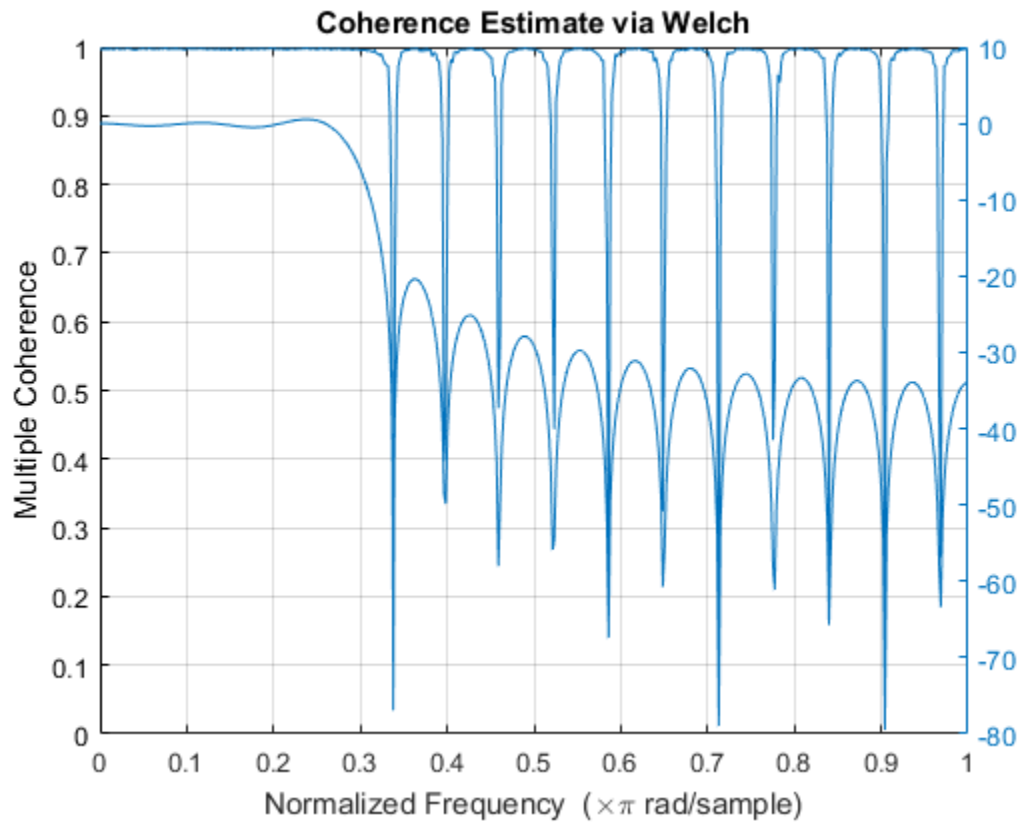

Compute and plot the ordinary magnitude-squared coherence estimate of x and y . The estimate does not reach 1 for any of the channels.

```
figure  
mscohere(x,y,hann(nfft),noverlap,nfft)
```

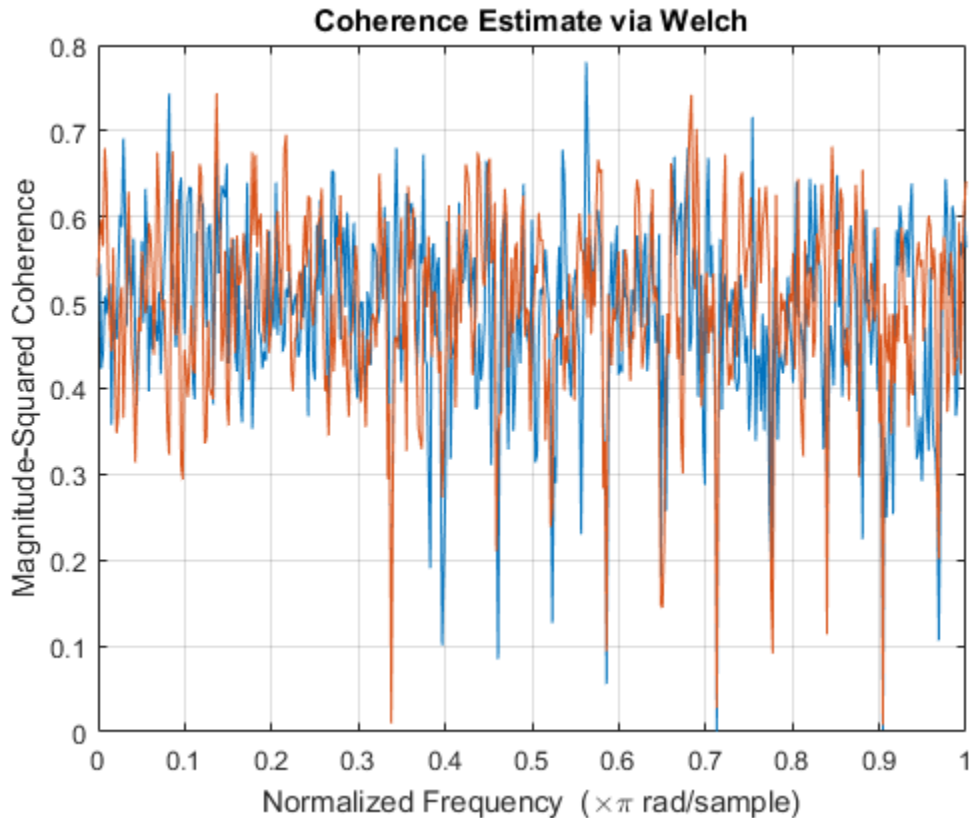

Coherence of MIMO System

Generate two multichannel signals, each sampled at 1 kHz for 2 seconds. The first signal, the input, consists of three sinusoids with frequencies of 120 Hz, 360 Hz, and 480 Hz. The second signal, the output, is composed of two sinusoids with frequencies of 120 Hz and 360 Hz. One of the sinusoids lags the first signal by $\pi/2$. The other sinusoid has a lag of $\pi/4$. Both signals are embedded in white Gaussian noise.

```
fs = 1000;
f = 120;
t = (0:1/fs:2-1/fs)';

inpt = sin(2*pi*f*[1 3 4].*t);
inpt = inpt+randn(size(inpt));
```

```
oupt = sin(2*pi*f*[1 3].*t-[pi/2 pi/4]);  
oupt = oupt+randn(size(oupt));
```

Estimate the degree of correlation between all the input signals and each of the output channels. Use a Hamming window of length 100 to window the data. `mscohere` returns one coherence function for each output channel. The coherence functions reach maxima at the frequencies shared by the input and the output.

```
[Cxy,f] = mscohere(inpt,oupt,hamming(100),[],[],fs,'mimo');  
  
for k = 1:size(oupt,2)  
    subplot(size(oupt,2),1,k)  
    plot(f,Cxy(:,k))  
    title(['Output ' int2str(k) ', All Inputs'])  
end
```

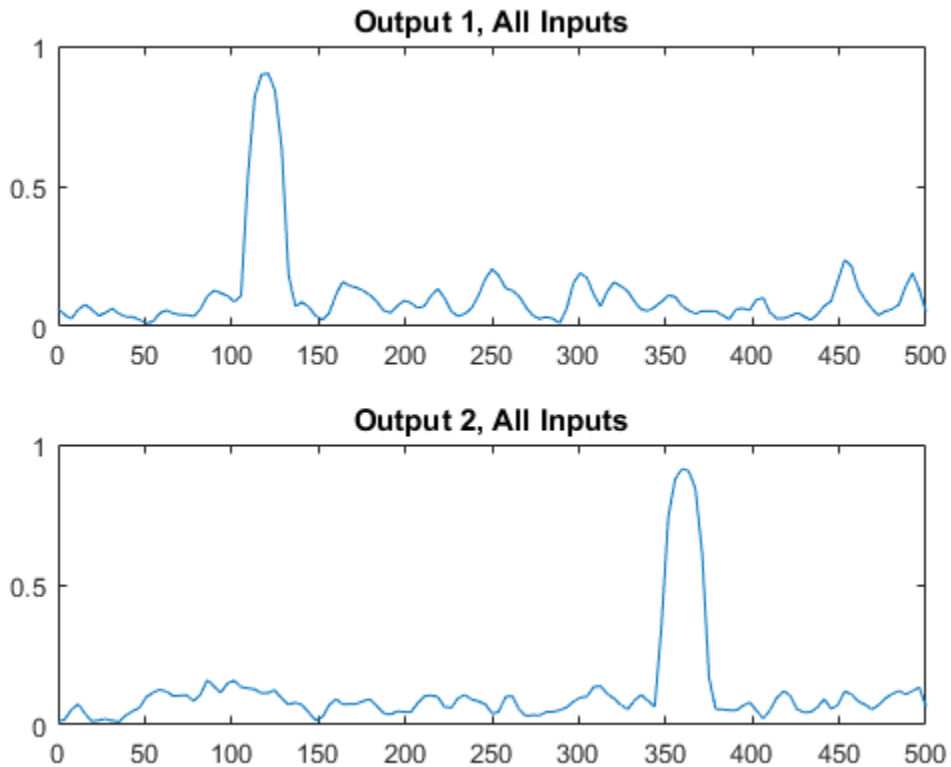

Switch the input and output signals and compute the multiple coherence function. Use the same Hamming window. There is no correlation between input and output at 480 Hz. Thus there are no peaks in the third correlation function.

```
[Cxy,f] = mscohere(oupt,inpt,hamming(100),[],[],fs,'mimo');

for k = 1:size(inpt,2)
    subplot(size(inpt,2),1,k)
    plot(f,Cxy(:,k))
    title(['Input ' int2str(k) ', All Outputs'])
end
```

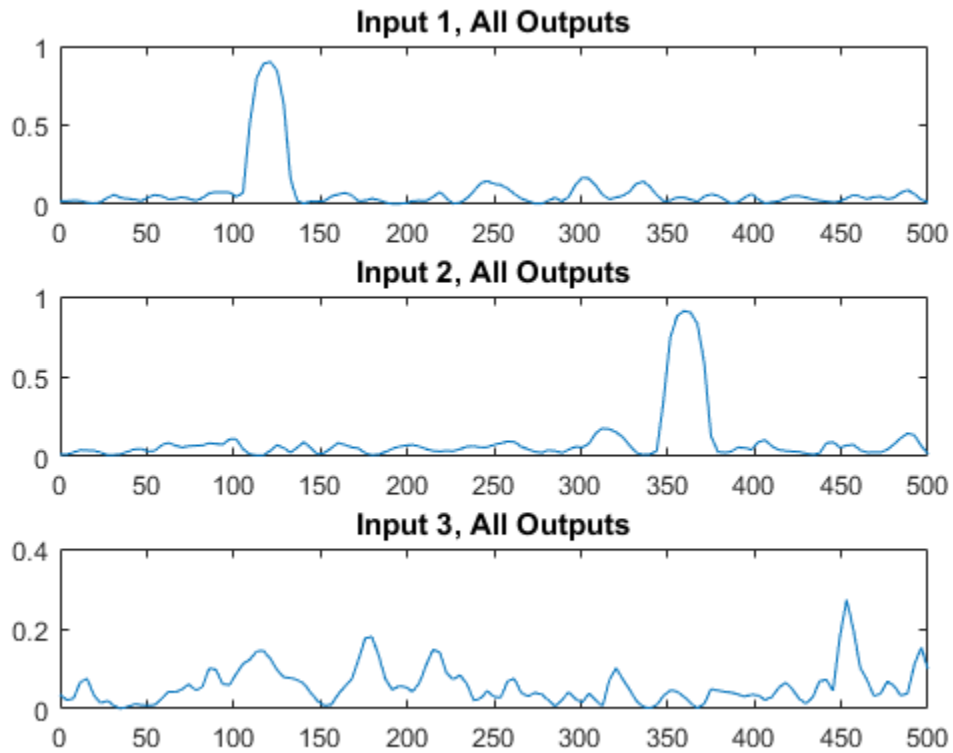
Repeat the computation, using the plotting functionality of `mscohere`.

```
clf
mscohere(oupt,inpt,hamming(100),[],[],fs,'mimo')
```

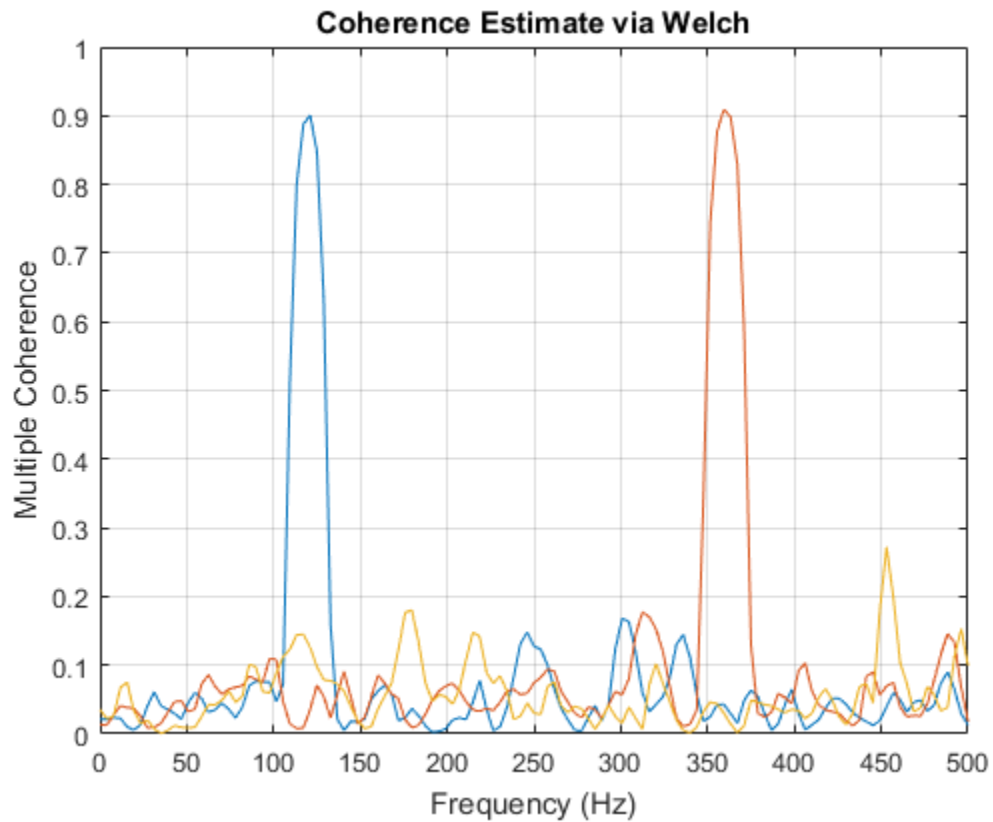

Compute the ordinary coherence function of the second signal and the first two channels of the first signal. The off-peak values differ from the multiple coherence function.

```
[Cxy,f] = mscohere(oupt,inpt(:,[1 2]),hamming(100),[],[],fs);  
plot(f,Cxy)
```

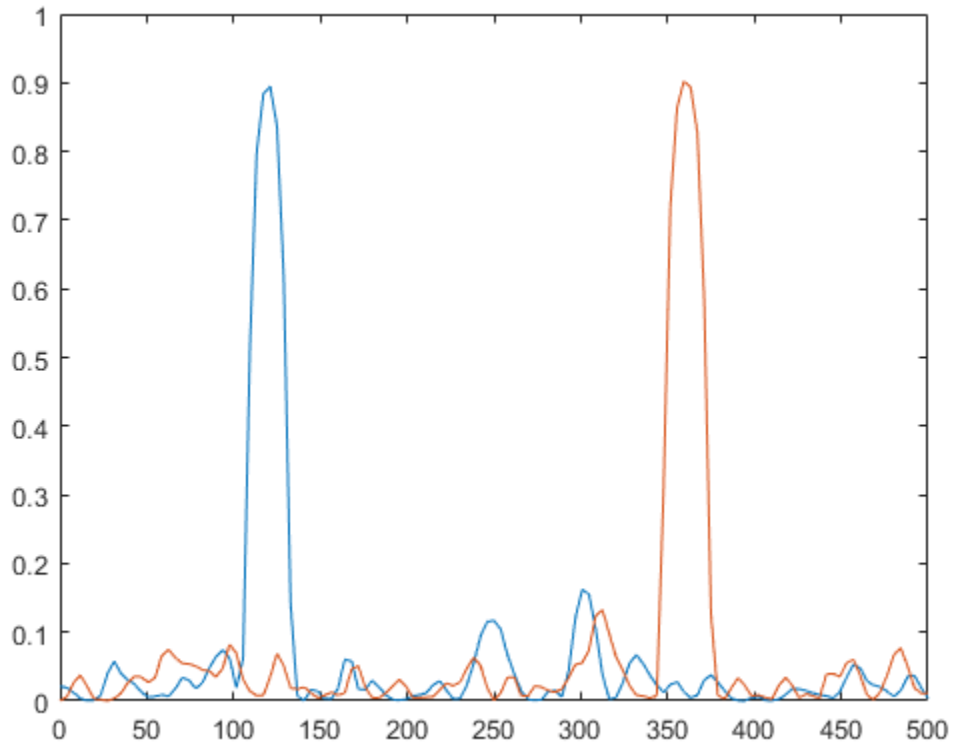

Find the phase differences by computing the angle of the cross-spectrum at the points of maximum coherence.

```
Pxy = cpsd(oupt,inpt(:,[1 2]),hamming(100),[],[],fs);
[~,mxx] = max(Cxy);
for k = 1:2
    fprintf('Phase lag %d = %5.2f*pi\n',k,angle(Pxy(mxx(k),k))/pi)
end
```

```
Phase lag 1 = -0.51*pi
```

```
Phase lag 2 = -0.22*pi
```

Modify Magnitude-Squared Coherence Plot

Generate two sinusoidal signals sampled for 1 second each at 1 kHz. Each sinusoid has a frequency of 250 Hz. One of the signals lags the other in phase by $\pi/3$ radians. Embed both signals in white Gaussian noise of unit variance.

```
fs = 1000;  
f = 250;  
t = 0:1/fs:1-1/fs;  
um = sin(2*pi*f*t)+rand(size(t));  
un = sin(2*pi*f*t-pi/3)+rand(size(t));
```

Use `mscohere` to compute and plot the magnitude-squared coherence of the signals.

```
mscohere(um,un,[],[],[],fs)
```

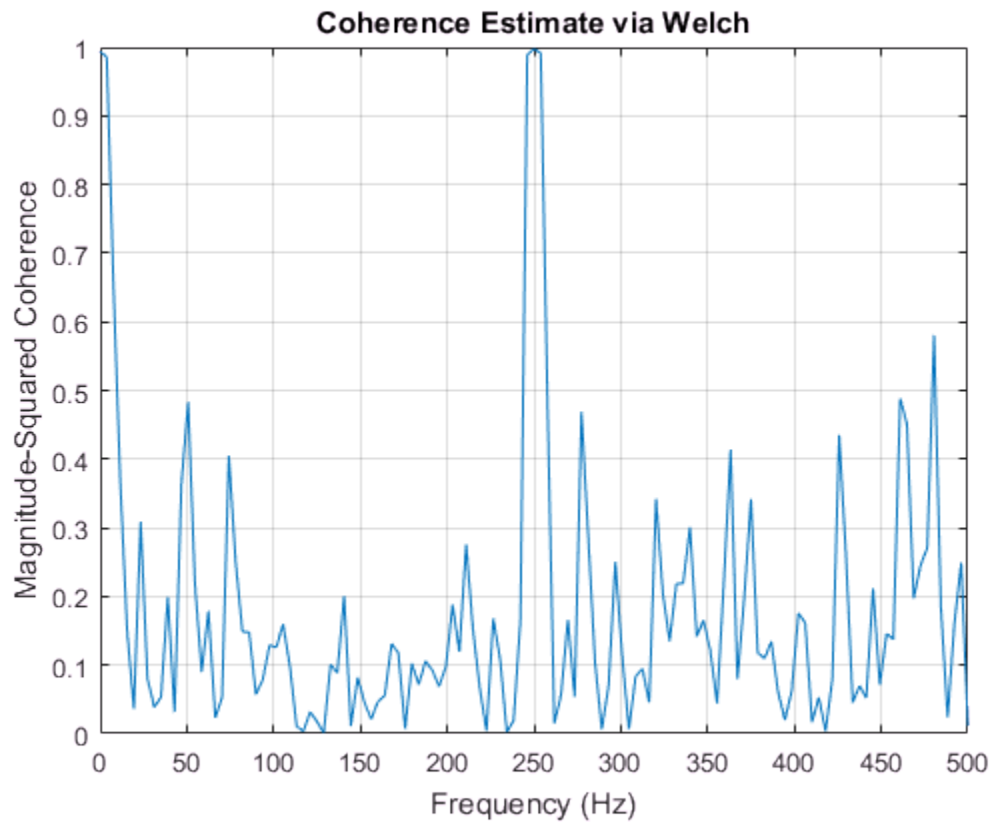

Modify the title of the plot, the label of the x -axis, and the limits of the y -axis.

```
title('Magnitude-Squared Coherence')  
xlabel('f (Hz)')  
ylim([0 1.1])
```

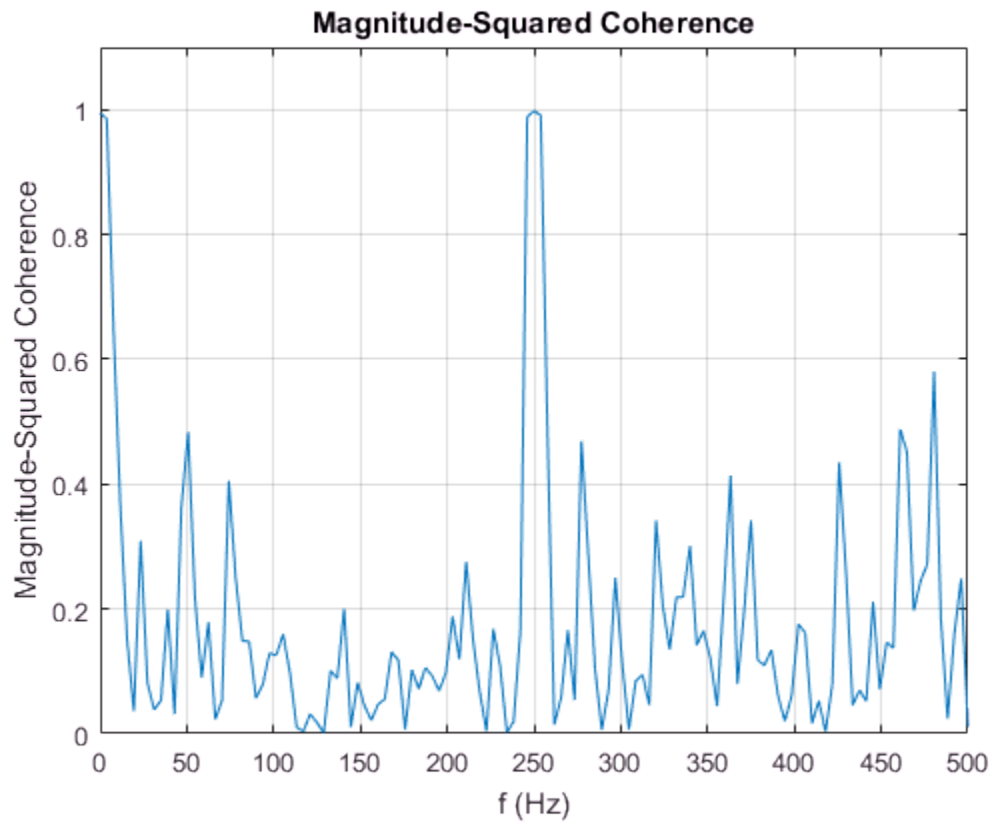

Use `gca` to obtain a handle to the current axes. Change the locations of the tick marks. Remove the label of the y-axis.

```
ax = gca;  
ax.XTick = 0:250:500;  
ax.YTick = 0:0.25:1;  
ax.YLabel.String = [];
```

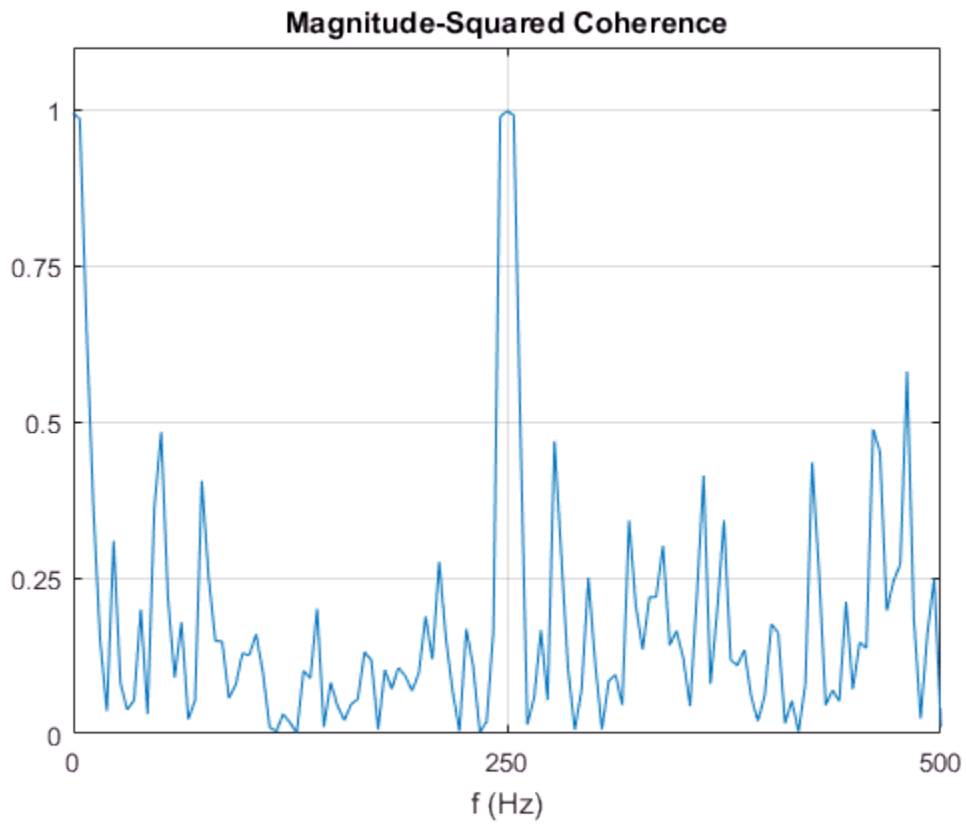

Call the `Children` property of the handle to change the color and width of the plotted line.

```
In = ax.Children;  
In.Color = [0.8 0 0];  
In.LineWidth = 1.5;
```

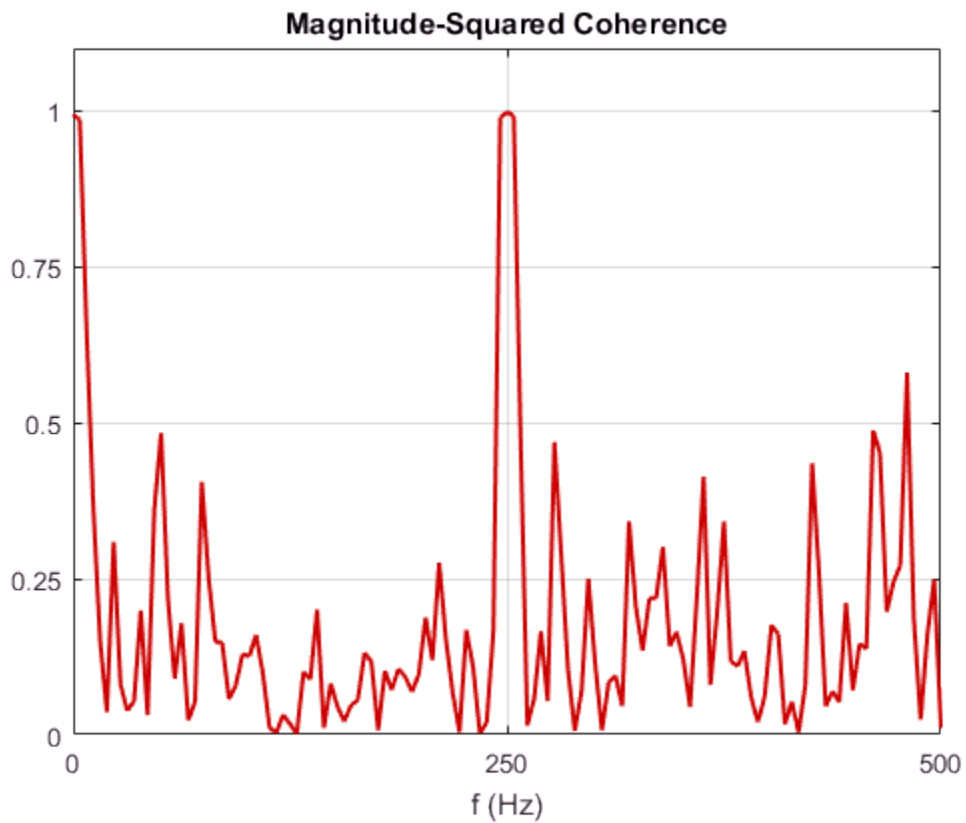

Alternatively, use `set` and `get` to modify the line properties.

```
set(get(gca, 'Children'), 'Color', [0 0.4 0], 'LineStyle', '--', 'LineWidth', 1)
```

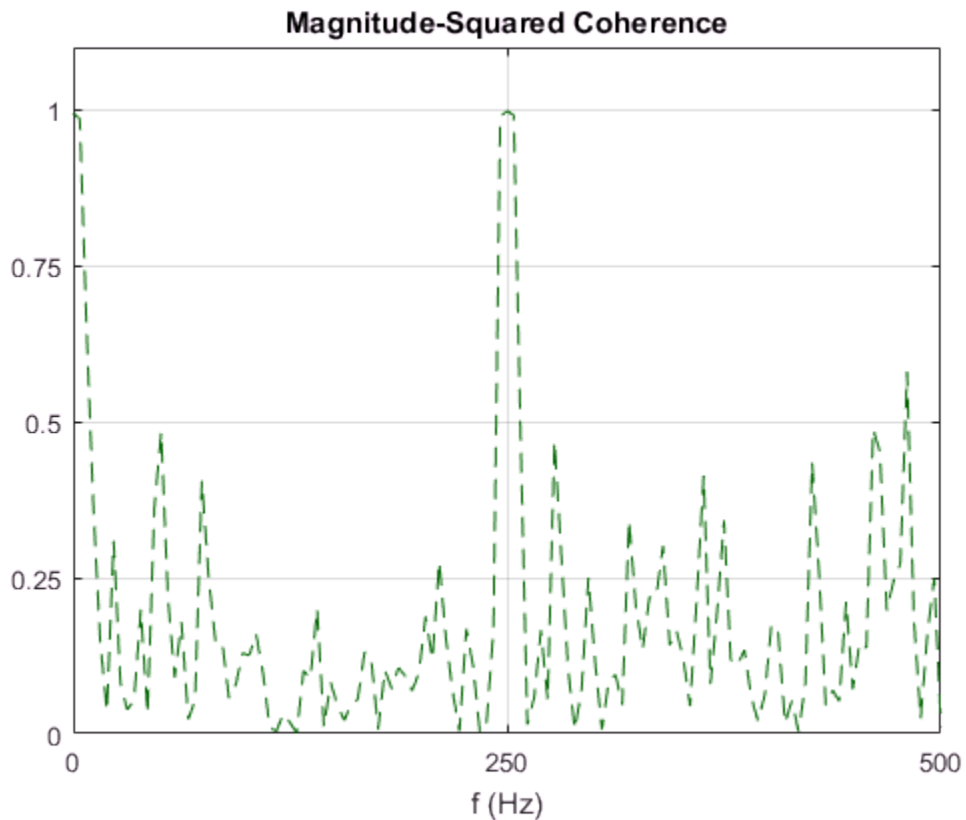
- “Cross Spectrum and Magnitude-Squared Coherence”
- “Compare the Frequency Content of Two Signals”

Input Arguments

x, y — Input signals

vectors | matrices

Input signals, specified as vectors or matrices.

Example: `cos(pi/4*(0:159))+randn(1,160)` specifies a sinusoid embedded in white Gaussian noise.

Data Types: `single` | `double`

Complex Number Support: Yes

window — Window

`integer` | `vector` | `[]`

Window, specified as an integer or as a row or column vector. Use `window` to divide the signal into segments:

- If `window` is an integer, then `mscohere` divides `x` and `y` into segments of length `window` and windows each segment with a Hamming window of that length.
- If `window` is a vector, then `mscohere` divides `x` and `y` into segments of the same length as the vector and windows each segment using `window`.

If the length of `x` and `y` cannot be divided exactly into an integer number of segments with `noverlap` overlapping samples, then the signals are truncated accordingly.

If you specify `window` as empty, then `mscohere` uses a Hamming window such that `x` and `y` are divided into eight segments with `noverlap` overlapping samples.

For a list of available windows, see “Windows”.

Example: `hann(N+1)` and `(1 - cos(2*pi*(0:N)'/N))/2` both specify a Hann window of length `N + 1`.

Data Types: `single` | `double`

noverlap — Number of overlapped samples

`positive integer` | `[]`

Number of overlapped samples, specified as a positive integer.

- If `window` is scalar, then `noverlap` must be smaller than `window`.
- If `window` is a vector, then `noverlap` must be smaller than the length of `window`.

If you specify `noverlap` as empty, then `mscohere` uses a number that produces 50% overlap between segments. If the segment length is unspecified, the function sets `noverlap` to $\lfloor N/4.5 \rfloor$, where `N` is the length of the input and output signals.

Data Types: `double` | `single`

nfft — Number of DFT points

`positive integer` | `[]`

Number of DFT points, specified as a positive integer. If you specify `nfft` as empty, then `mscohere` sets this argument to $\max(256, 2^p)$, where $p = \lceil \log_2 N \rceil$ for input signals of length N .

Data Types: `single` | `double`

fs — Sample rate

positive scalar

Sample rate, specified as a positive scalar. The sample rate is the number of samples per unit time. If the unit of time is seconds, then the sample rate has units of Hz.

w — Normalized frequencies

vector

Normalized frequencies, specified as a row or column vector with at least two elements. Normalized frequencies are in rad/sample.

Example: `w = [pi/4 pi/2]`

Data Types: `double`

f — Frequencies

vector

Frequencies, specified as a row or column vector with at least two elements. The frequencies are in cycles per unit time. The unit time is specified by the sample rate, `fs`. If `fs` has units of samples/second, then `f` has units of Hz.

Example: `fs = 1000; f = [100 200]`

Data Types: `double`

freange — Frequency range for magnitude-squared coherence estimate

'onesided' | 'twosided' | 'centered'

Frequency range for the magnitude-squared coherence estimate, specified as 'onesided', 'twosided', or 'centered'. The default is 'onesided' for real-valued signals and 'twosided' for complex-valued signals.

- 'onesided' — Returns the one-sided estimate of the magnitude-squared coherence estimate between two real-valued input signals, x and y . If `nfft` is even, `cxy` has $nfft/2 + 1$ rows and is computed over the interval $[0, \pi]$ rad/sample. If `nfft` is odd, `cxy` has $(nfft + 1)/2$ rows and the interval is $[0, \pi]$ rad/sample. If you specify `fs`, the

corresponding intervals are $[0, f_s/2]$ cycles/unit time for even `nfft` and $[0, f_s/2)$ cycles/unit time for odd `nfft`.

- `'twosided'` — Returns the two-sided estimate of the magnitude-squared coherence estimate between two real-valued or complex-valued input signals, `x` and `y`. In this case, `cxy` has `nfft` rows and is computed over the interval $[0, 2\pi]$ rad/sample. If you specify `fs`, the interval is $[0, fs)$ cycles/unit time.
- `'centered'` — Returns the centered two-sided estimate of the magnitude-squared coherence estimate between two real-valued or complex-valued input signals, `x` and `y`. In this case, `cxy` has `nfft` rows and is computed over the interval $(-\pi, \pi]$ rad/sample for even `nfft` and $(-\pi, \pi)$ rad/sample for odd `nfft`. If you specify `fs`, the corresponding intervals are $(-fs/2, fs/2]$ cycles/unit time for even `nfft` and $(-fs/2, fs/2)$ cycles/unit time for odd `nfft`.

Data Types: char

Output Arguments

cxy — Magnitude-squared coherence estimate

vector | matrix | three-dimensional array

Magnitude-squared coherence estimate, returned as a vector, matrix, or three-dimensional array.

w — Normalized frequencies

vector

Normalized frequencies, returned as a real-valued column vector.

f — Frequencies

vector

Frequencies, returned as a real-valued column vector.

Definitions

Magnitude-Squared Coherence

The magnitude-squared coherence estimate is a function of frequency with values between 0 and 1. These values indicate how well `x` corresponds to `y` at each frequency.

The magnitude-squared coherence is a function of the power spectral densities, $P_{xx}(f)$ and $P_{yy}(f)$, and the cross power spectral density, $P_{xy}(f)$, of x and y :

$$C_{xy}(f) = \frac{|P_{xy}(f)|^2}{P_{xx}(f)P_{yy}(f)}.$$

For multi-input/multi-output systems, the multiple-coherence function becomes

$$C_{Xy_i}(f) = \frac{P_{Xy_i}(f)P_{XX}^{-1}(f)P_{xy_i}(f)}{P_{y_iy_i}(f)}$$

$$= \begin{bmatrix} P_{x_1y_i}^*(f) & \cdots & P_{x_my_i}^*(f) \end{bmatrix} \begin{bmatrix} P_{x_1x_1}(f) & P_{x_1x_2}(f) & \cdots & P_{x_1x_m}(f) \\ P_{x_2x_1}(f) & P_{x_2x_2}(f) & \cdots & P_{x_2x_m}(f) \\ \vdots & \vdots & \ddots & \vdots \\ P_{x_mx_1}(f) & P_{x_mx_2}(f) & \cdots & P_{x_mx_m}(f) \end{bmatrix}^{-1} \begin{bmatrix} P_{x_1y_i}(f) \\ \vdots \\ P_{x_my_i}(f) \end{bmatrix} \frac{1}{P_{y_iy_i}(f)}$$

for the i th output signal, where:

- X corresponds to the array of m inputs.
- P_{Xy_i} is the m -dimensional vector of cross power spectral densities between the inputs and y_i .
- P_{XX} is the m -by- m matrix of power spectral densities and cross power spectral densities of the inputs.
- $P_{y_iy_i}$ is the power spectral density of the output.
- The dagger (\dagger) stands for the complex conjugate transpose.

Algorithms

mscohere estimates the magnitude-squared coherence function [2] using Welch's overlapped averaged periodogram method [3], [5].

References

- [1] Gómez González, A., J. Rodríguez, X. Sagartzazu, A. Schumacher, and I. Isasa. "Multiple Coherence Method in Time Domain for the Analysis of the

Transmission Paths of Noise and Vibrations with Non-Stationary Signals.”
*Proceedings of the 2010 International Conference of Noise and Vibration
Engineering, ISMA2010-USD2010*. pp.3927–3941.

[2] Kay, Steven M. *Modern Spectral Estimation*. Englewood Cliffs, NJ: Prentice-Hall, 1988.

[3] Rabiner, Lawrence R., and Bernard Gold. *Theory and Application of Digital Signal Processing*. Englewood Cliffs, NJ: Prentice-Hall, 1975.

[4] Stoica, Petre, and Randolph Moses. *Spectral Analysis of Signals*. Upper Saddle River, NJ: Prentice Hall, 2005.

[5] Welch, Peter D. “The Use of Fast Fourier Transform for the Estimation of Power Spectra: A Method Based on Time Averaging Over Short, Modified Periodograms.” *IEEE Transactions on Audio and Electroacoustics*. Vol. AU-15, 1967, pp. 70–73.

See Also

See Also

`cpsd` | `periodogram` | `pwelch` | `tffestimate`

Topics

“Cross Spectrum and Magnitude-Squared Coherence”

“Compare the Frequency Content of Two Signals”

Introduced before R2006a

nuttallwin

Nuttall-defined minimum 4-term Blackman-Harris window

Syntax

```
w = nuttallwin(N)
w = nuttalwin(N,SFLAG)
```

Description

`w = nuttallwin(N)` returns a Nuttall defined N -point, 4-term symmetric Blackman-Harris window in the column vector w . The window is minimum in the sense that its maximum sidelobes are minimized. The coefficients for this window differ from the Blackman-Harris window coefficients computed with `blackmanharris` and produce slightly lower sidelobes.

`w = nuttalwin(N,SFLAG)` uses `SFLAG` window sampling. `SFLAG` can be `'symmetric'` or `'periodic'`. The default is `'symmetric'`. You can find the equations defining the symmetric and periodic windows in “Algorithms” on page 1-1346.

Examples

Nuttall and Blackman-Harris Windows

Compare 64-point Nuttall and Blackman-Harris windows. Plot them using `wvtool`.

```
L = 64;
w = blackmanharris(L);
y = nuttallwin(L);
wvtool(w,y)
```

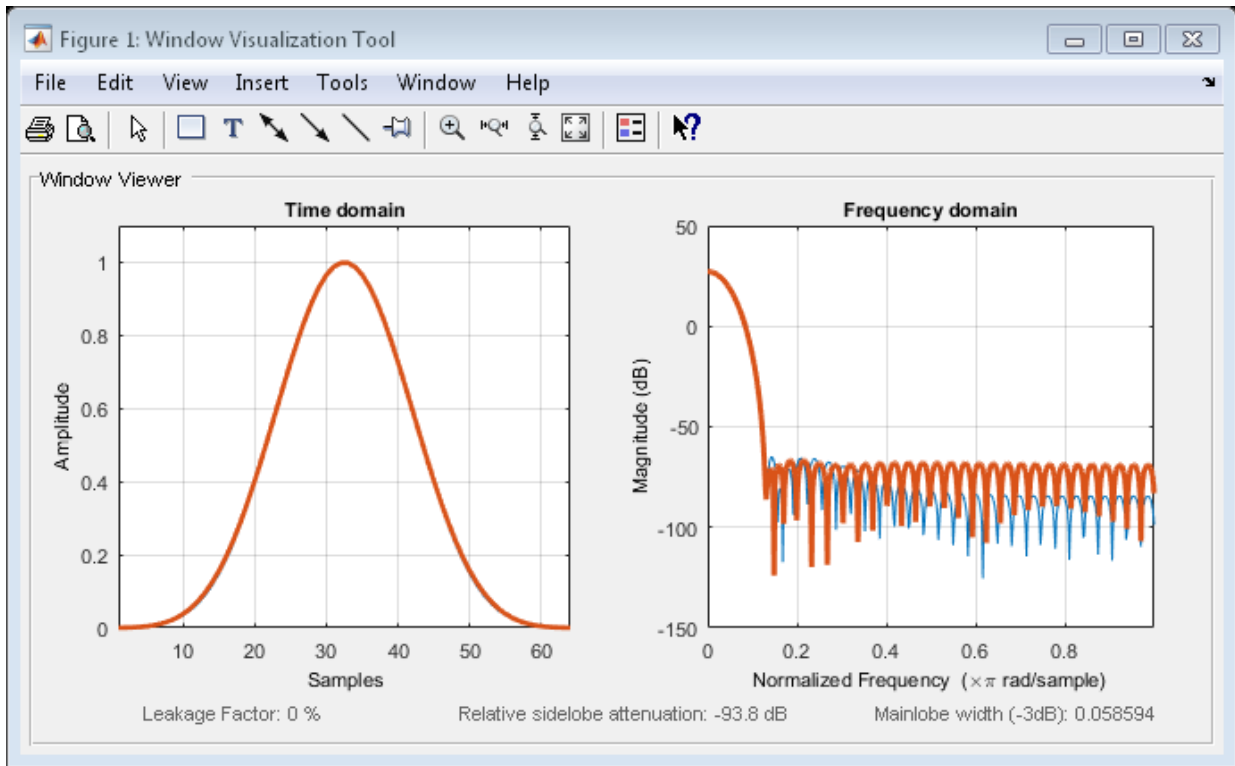

Compute the maximum difference between the two windows.

```
max(abs(y-w))
```

```
ans = 0.0099
```

Algorithms

The equation for the *symmetric* Nuttall defined four-term Blackman-Harris window is

$$w(n) = a_0 - a_1 \cos\left(2\pi \frac{n}{N-1}\right) + a_2 \cos\left(4\pi \frac{n}{N-1}\right) - a_3 \cos\left(6\pi \frac{n}{N-1}\right)$$

where $n=0,1,2, \dots N-1$.

The equation for the *periodic* Nuttall defined four-term Blackman-Harris window is

$$w(n) = a_0 - a_1 \cos\left(2\pi \frac{n}{N}\right) + a_2 \cos\left(4\pi \frac{n}{N}\right) - a_3 \cos\left(6\pi \frac{n}{N}\right)$$

where $n=0,1,2, \dots N-1$. The periodic window is N-periodic.

The coefficients for this window are

$$a_0 = 0.3635819$$

$$a_1 = 0.4891775$$

$$a_2 = 0.1365995$$

$$a_3 = .0106411$$

References

- [1] Nuttall, Albert H. "Some Windows with Very Good Sidelobe Behavior." *IEEE Transactions on Acoustics, Speech, and Signal Processing*. Vol. ASSP-29, February 1981, pp. 84–91.

Extended Capabilities

C/C++ Code Generation

Generate C and C++ code using MATLAB® Coder™.

Usage notes and limitations:

All inputs must be constant. Expressions or variables are allowed if their values do not change.

See Also

See Also

Apps

Window Designer

Functions

barthannwin | bartlett | blackmanharris | bohmanwin | parzenwin | rectwin
| triang | window | wvtool

Introduced before R2006a

obw

Occupied bandwidth

Syntax

`bw = obw(x)`

`bw = obw(x, fs)`

`bw = obw(pxx, f)`

`bw = obw(sxx, f, rbw)`

`bw = obw(____, freqrange, p)`

`[bw, flo, fhi, power] = obw(____,)`

`obw(____,)`

Description

`bw = obw(x)` returns the 99% occupied bandwidth, `bw`, of the input signal, `x`.

`bw = obw(x, fs)` returns the occupied bandwidth in terms of the sample rate, `fs`.

`bw = obw(pxx, f)` returns the 99% occupied bandwidth of the power spectral density (PSD) estimate, `pxx`. The frequencies, `f`, correspond to the estimates in `pxx`.

`bw = obw(sxx, f, rbw)` computes the occupied bandwidth of the power spectrum estimate, `sxx`. The frequencies, `f`, correspond to the estimates in `sxx`. `rbw` is the resolution bandwidth used to integrate each power estimate.

`bw = obw(____, freqrange, p)` specifies the frequency interval over which to compute the occupied bandwidth, using any of the input arguments from previous syntaxes.

This syntax also specifies `p`, the percentage of the total signal power contained in the occupied band.

`[bw, flo, fhi, power] = obw(___)` also returns the lower and upper bounds of the occupied bandwidth and the occupied band power.

`obw(___)` with no output arguments plots the PSD or power spectrum in the current figure window and annotates the bandwidth.

Examples

Occupied Bandwidth of Chirps

Generate 1024 samples of a chirp sampled at 1024 kHz. The chirp has an initial frequency of 50 kHz and reaches 100 kHz at the end of the sampling. Add white Gaussian noise such that the signal-to-noise ratio is 40 dB. Reset the random number generator for reproducible results.

```
nSamp = 1024;  
Fs = 1024e3;  
SNR = 40;  
rng default  
  
t = (0:nSamp-1)'/Fs;  
  
x = chirp(t,50e3,nSamp/Fs,100e3);  
x = x+randn(size(x))*std(x)/db2mag(SNR);
```

Estimate the occupied bandwidth of the signal and annotate it on a plot of the power spectral density (PSD).

```
obw(x,Fs)  
  
ans = 5.5377e+04
```

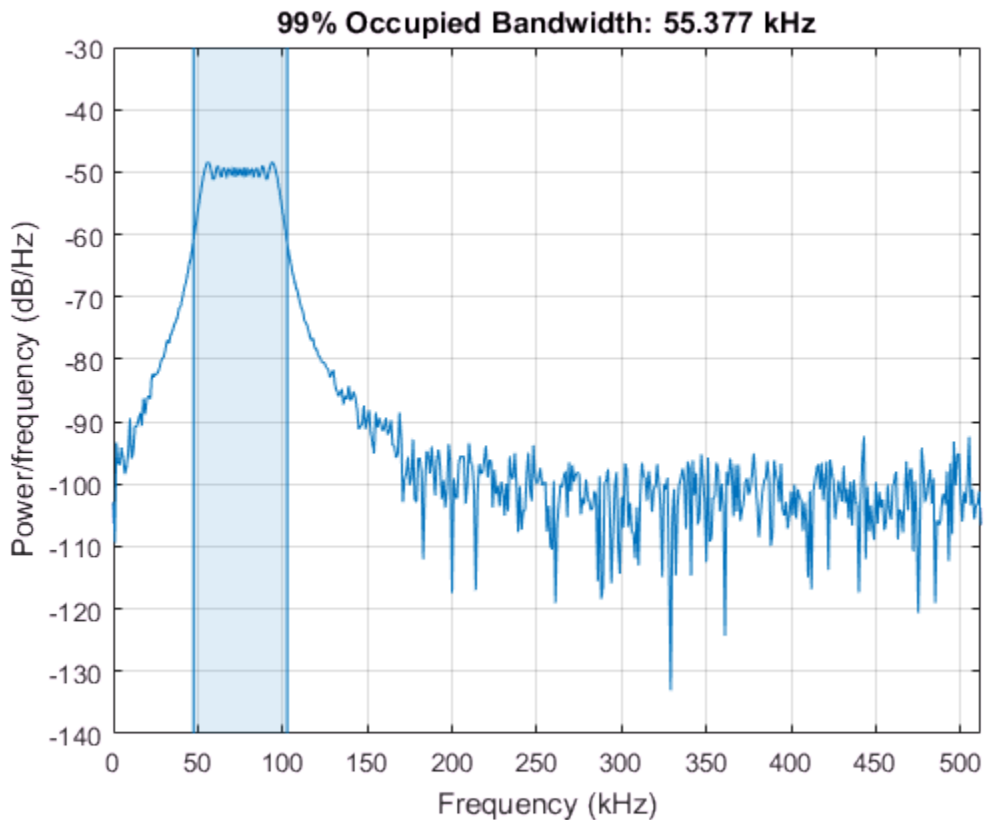

Generate another chirp. Specify an initial frequency of 200 kHz, a final frequency of 300 kHz, and an amplitude that is twice that of the first signal. Add white Gaussian noise.

```
x2 = 2*chirp(t,200e3,nSamp/Fs,300e3);
x2 = x2+randn(size(x2))*std(x2)/db2mag(SNR);
```

Concatenate the chirps to produce a two-channel signal. Estimate the occupied bandwidth of each channel.

```
y = obw([x x2],Fs)
```

```
y =
```

```
1.0e+05 *
```

0.5538 1.0546

Annotate the occupied bandwidths of the two channels on a plot of the PSDs.

```
obw([x x2],Fs);
```

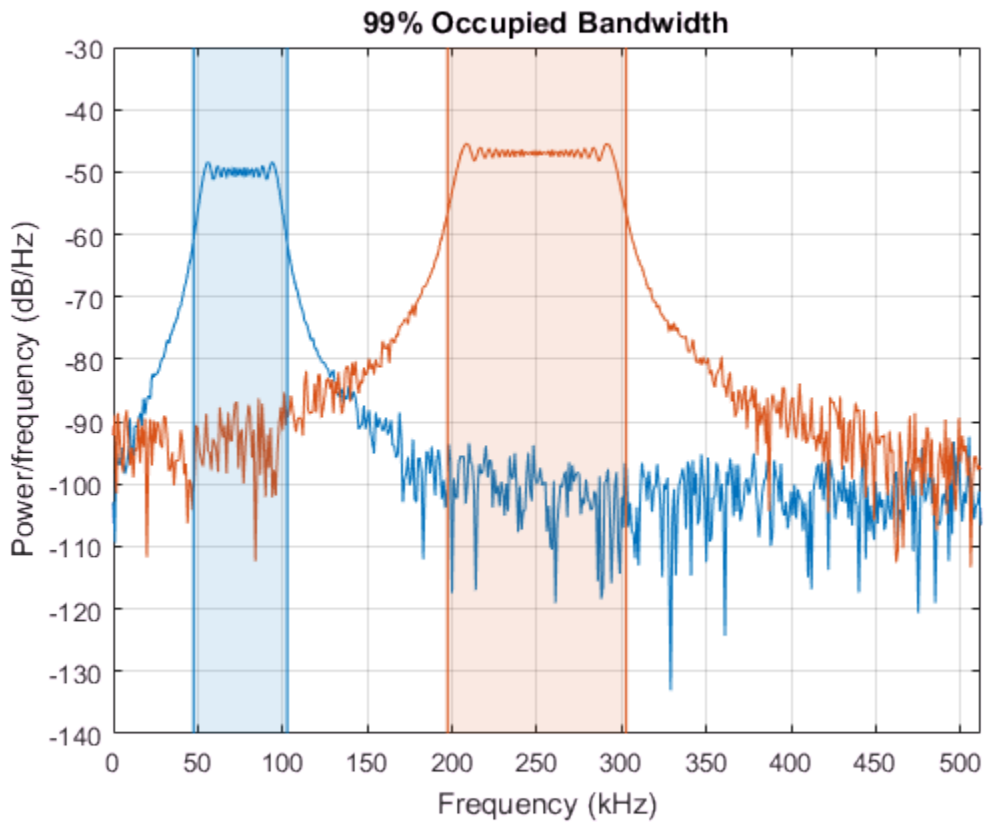

Add the two channels to form a new signal. Plot the PSD and annotate the occupied bandwidth.

```
obw(x+x2,Fs);
```

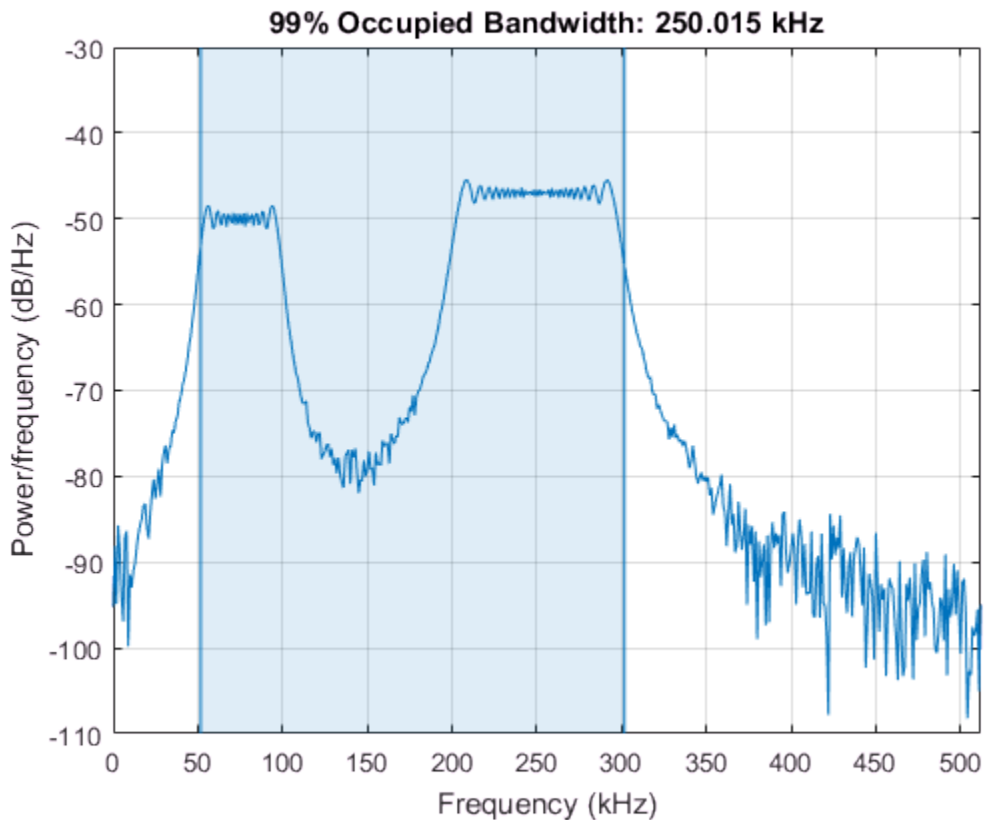

Occupied Bandwidth of Sinusoids

Generate 1024 samples of a 100.123 kHz sinusoid sampled at 1024 kHz. Add white Gaussian noise such that the signal-to-noise ratio is 40 dB. Reset the random number generator for reproducible results.

```
nSamp = 1024;
Fs = 1024e3;
SNR = 40;
rng default

t = (0:nSamp-1)'/Fs;
```

```
x = sin(2*pi*t*100.123e3);
x = x + randn(size(x))*std(x)/db2mag(SNR);
```

Use the `periodogram` function to compute the power spectral density (PSD) of the signal. Specify a Kaiser window with the same length as the signal and a shape factor of 38. Estimate the occupied bandwidth of the signal and annotate it on a plot of the PSD.

```
[Pxx,f] = periodogram(x,kaiser(nSamp,38),[],Fs);
obw(Pxx,f);
```

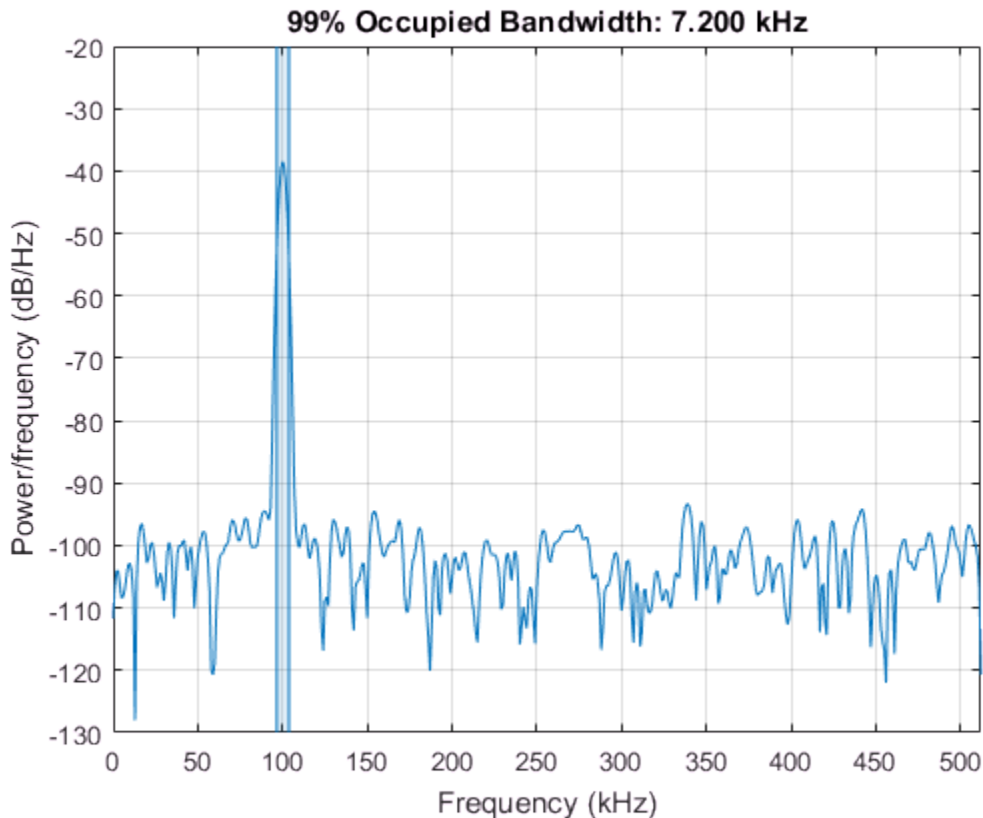

Generate another sinusoid, this one with a frequency of 257.321 kHz and an amplitude that is twice that of the first sinusoid. Add white Gaussian noise.

```
x2 = 2*sin(2*pi*t*257.321e3);  
x2 = x2 + randn(size(x2))*std(x2)/db2mag(SNR);
```

Concatenate the sinusoids to produce a two-channel signal. Estimate the PSD of each channel and use the result to determine the occupied bandwidth.

```
[Pyy,f] = periodogram([x x2],kaiser(nSamp,38),[],Fs);
```

```
y = obw(Pyy,f)
```

```
y =
```

```
1.0e+03 *  
7.2001    7.3777
```

Annotate the occupied bandwidths of the two channels on a plot of the PSDs.

```
obw(Pyy,f);
```

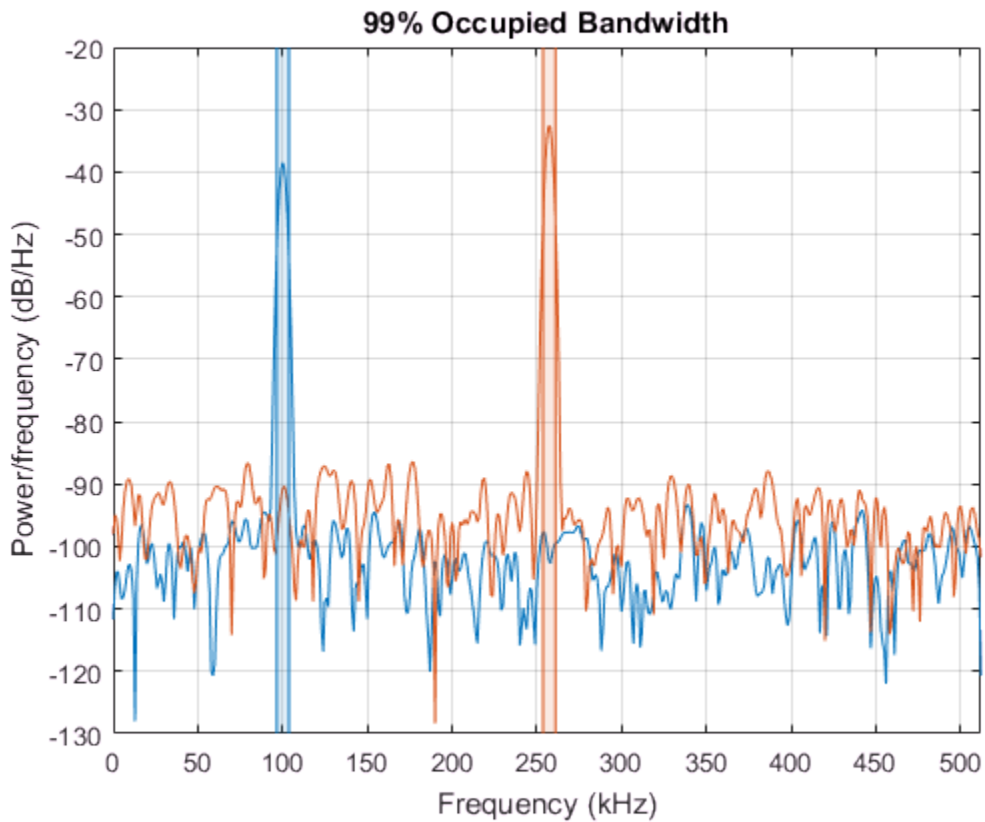

Add the two channels to form a new signal. Estimate the PSD and annotate the occupied bandwidth.

```
[Pzz,f] = periodogram(x+x2,kaiser(nSamp,38),[],Fs);
```

```
obw(Pzz,f);
```

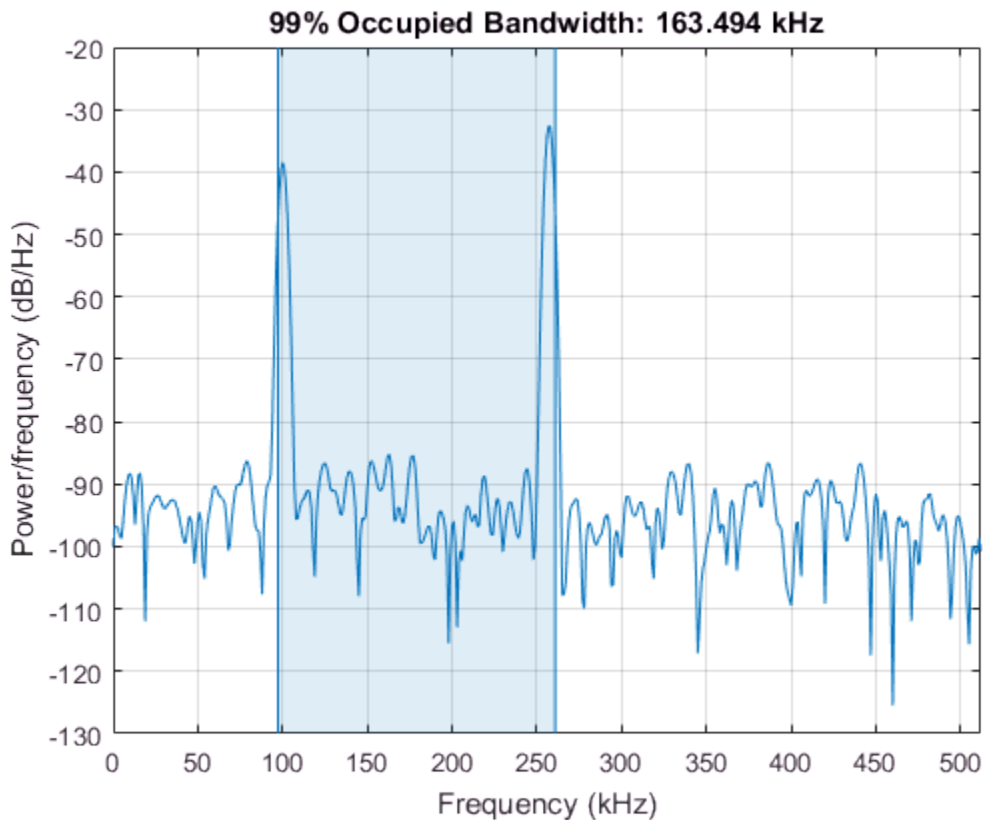

Occupied Bandwidth of Bandlimited Signals

Generate a signal whose PSD resembles the frequency response of an 88th-order bandpass FIR filter with normalized cutoff frequencies 0.25π rad/sample and 0.45π rad/sample.

```
d = fir1(88,[0.25 0.45]);
```

Compute the 99% occupied bandwidth of the signal between 0.2π rad/sample and 0.6π rad/sample. Plot the PSD and annotate the occupied bandwidth and measurement interval.

```
obw(d,[],[0.2 0.6]*pi);
```

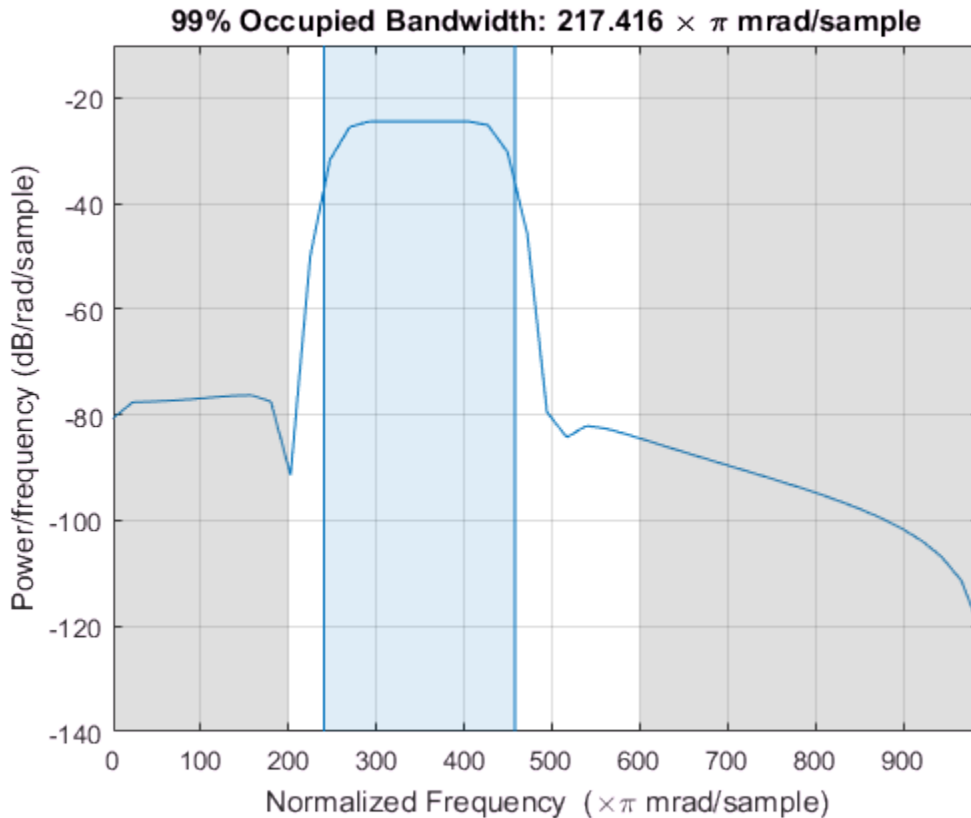

Output the occupied bandwidth, its lower and upper bounds, and the occupied band power. Specifying a sample rate of 2π is equivalent to leaving the rate unset.

```
[bw,flo,fhi,power] = obw(d,2*pi,[0.2 0.6]*pi);
fprintf('bw = %.3f*pi, flo = %.3f*pi, fhi = %.3f*pi \n',[bw flo fhi]/pi)
bw = 0.217*pi, flo = 0.240*pi, fhi = 0.458*pi
fprintf('power = %.1f%% of total',power/bandpower(d)*100)
power = 99.0% of total
```

Add a second channel with normalized cutoff frequencies 0.5π rad/sample and 0.8π rad/sample and an amplitude that is one-tenth that of the first channel.

```
d = [d;fir1(88,[0.5 0.8])/10]';
```

Compute the 50% occupied bandwidth of the signal between 0.3π rad/sample and 0.9π rad/sample. Plot the PSD and annotate the occupied bandwidth and measurement interval.

```
obw(d,[],[0.3 0.9]*pi,50);
```

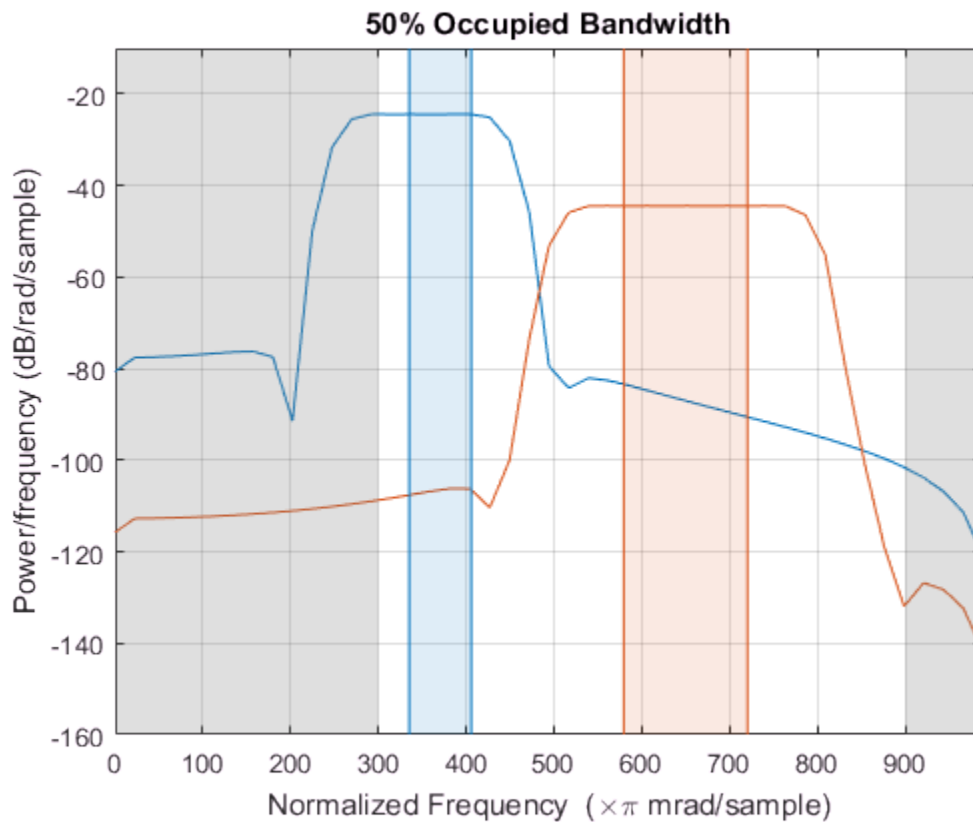

Output the occupied bandwidth of each channel. Divide by π .

```
bw = obw(d,[],[0.3 0.9]*pi,50)/pi
bw =
    0.0705    0.1412
```

Input Arguments

x — Input signal

vector | matrix

Input signal, specified as a vector or matrix. If **x** is a vector, it is treated as a single channel. If **x** is a matrix, then **obw** computes the occupied bandwidth independently for each column. **x** must be finite-valued.

Example: `cos(pi/4*(0:159))+randn(1,160)` is a single-channel row-vector signal.

Example: `cos(pi./[4;2]*(0:159))'+randn(160,2)` is a two-channel signal.

Data Types: `single` | `double`

fs — Sample rate

positive real scalar

Sample rate, specified as a positive real scalar. The sample rate is the number of samples per unit time. If the time is measured in seconds, then the sample rate is in hertz.

Data Types: `single` | `double`

pxx — Power spectral density

vector | matrix

Power spectral density (PSD), specified as a vector or matrix. If **pxx** is a one-sided estimate, then it must correspond to a real signal. If **pxx** is a matrix, then **obw** computes the occupied bandwidth of each column of **pxx** independently.

Example: `periodogram(cos(pi./[4;2]*(0:159))'+randn(160,2))` is the periodogram PSD estimate of a two-channel sinusoid embedded in white Gaussian noise.

Data Types: `single` | `double`

f — Frequencies

vector

Frequencies, specified as a vector.

Data Types: `single` | `double`

sxx — Power spectrum estimate

vector | matrix

Power spectrum estimate, specified as a vector or matrix. If **sxx** is a matrix, then **obw** computes the occupied bandwidth of each column of **sxx** independently.

Example: `periodogram(cos(pi./[4;2]*(0:159))'+randn(160,2),'power')` is the periodogram power spectrum estimate of a two-channel sinusoid embedded in white Gaussian noise.

Data Types: `single` | `double`

rbw — Resolution bandwidth

positive scalar

Resolution bandwidth, specified as a positive scalar. The resolution bandwidth is the product of two values: the frequency resolution of the discrete Fourier transform and the equivalent noise bandwidth of the window used to compute the PSD.

Data Types: `single` | `double`

freqrange — Frequency range

two-element vector

Frequency range, specified as a two-element vector of real values. If you do not specify **freqrange**, then **obw** uses the entire bandwidth of the input signal.

Data Types: `single` | `double`

p — Power percentage

99 (default) | positive scalar

Power percentage, specified as a positive scalar between 0 and 100. **obw** computes the difference in frequency between the points where the integrated power crosses the $\frac{1}{2}(100 - p)$ and $\frac{1}{2}(100 + p)$ percentages of the total power in the spectrum.

Data Types: `single` | `double`

Output Arguments

bw — Occupied bandwidth

scalar | vector

Occupied bandwidth, returned as a scalar or vector.

- If you specify a sample rate, then **bw** has the same units as **fs**.
- If you do not specify a sample rate, then **bw** has units of rad/sample.

flo, fhi — Bandwidth frequency bounds

scalars | vectors

Bandwidth frequency bounds, returned as scalars or vectors.

power — Power stored in bandwidth

scalar | vector

Power stored in bandwidth, returned as a scalar or vector.

Algorithms

To determine the occupied bandwidth, **obw** computes a periodogram power spectral density estimate using a rectangular window and integrates the estimate using the midpoint rule. The occupied bandwidth is the difference in frequency between the points where the integrated power crosses 0.5% and 99.5% of the total power in the spectrum.

See Also

See Also

[bandpower](#) | [periodogram](#) | [plomb](#) | [powerbw](#) | [pwelch](#)

Introduced in R2015a

orderspectrum

Average spectrum versus order for vibration signal

Syntax

```
spec = orderspectrum(x,fs,rpm)
[spec,order] = orderspectrum(x,fs,rpm)
[spec,order] = orderspectrum(map,order)
orderspectrum( ___ )
```

Description

`spec = orderspectrum(x,fs,rpm)` computes an average order-magnitude spectrum vector, `spec`, for an input signal, `x`, sampled at a rate of `fs` Hz. To compute the spectrum, `orderspectrum` windows a constant-phase, resampled version of `x` with a flat top window.

`[spec,order] = orderspectrum(x,fs,rpm)` also returns a vector of the orders corresponding to each average spectrum value.

`[spec,order] = orderspectrum(map,order)` computes an average order-magnitude spectrum vector starting from an order-RPM map and a vector of orders. Use `rpmordermap` to compute `map` and `order`. `map` must be linearly scaled. The returned amplitudes are the same as in `map`. The returned spectrum is scaled linearly.

`orderspectrum(___)` with no output arguments plots the RMS amplitude of the order spectrum, scaled linearly, on the current figure.

Examples

Average Order Spectrum of Chirp with Four Orders

Create a simulated signal sampled at 600 Hz for 5 seconds. The system that is being tested increases its rotational speed from 10 to 40 revolutions per second during the observation period.

Generate the tachometer readings.

```
fs = 600;
t1 = 5;
t = 0:1/fs:t1;

f0 = 10;
f1 = 40;
rpm = 60*linspace(f0,f1,length(t));
```

The signal consists of four harmonically related chirps with orders 1, 0.5, 4, and 6. The order-4 chirp has twice the amplitude of the others. To generate the chirps, use the trapezoidal rule to express the phase as the integral of the rotational speed.

```
o1 = 1;
o2 = 0.5;
o3 = 4;
o4 = 6;

ph = 2*pi*cumtrapz(rpm/60)/fs;
x = [1 1 2 1]*cos([o1 o2 o3 o4]'*ph);
```

Visualize the order-RPM map of the signal.

```
rpmordermap(x, fs, rpm)
```

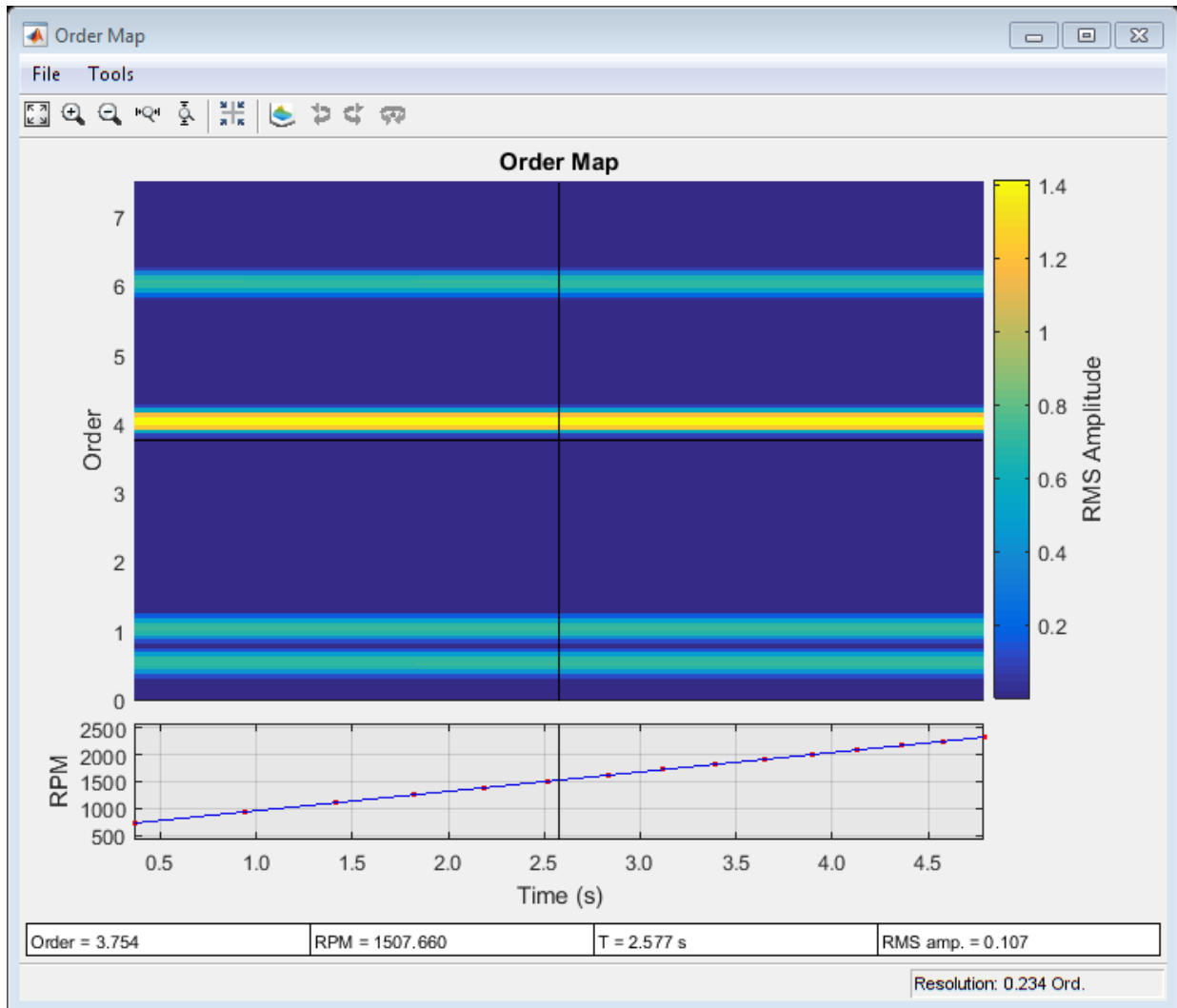

Visualize the average order spectrum of the signal. The peaks of the spectrum correspond to the ridges seen in the order-RPM map.

```
orderspectrum(x, fs, rpm)
```

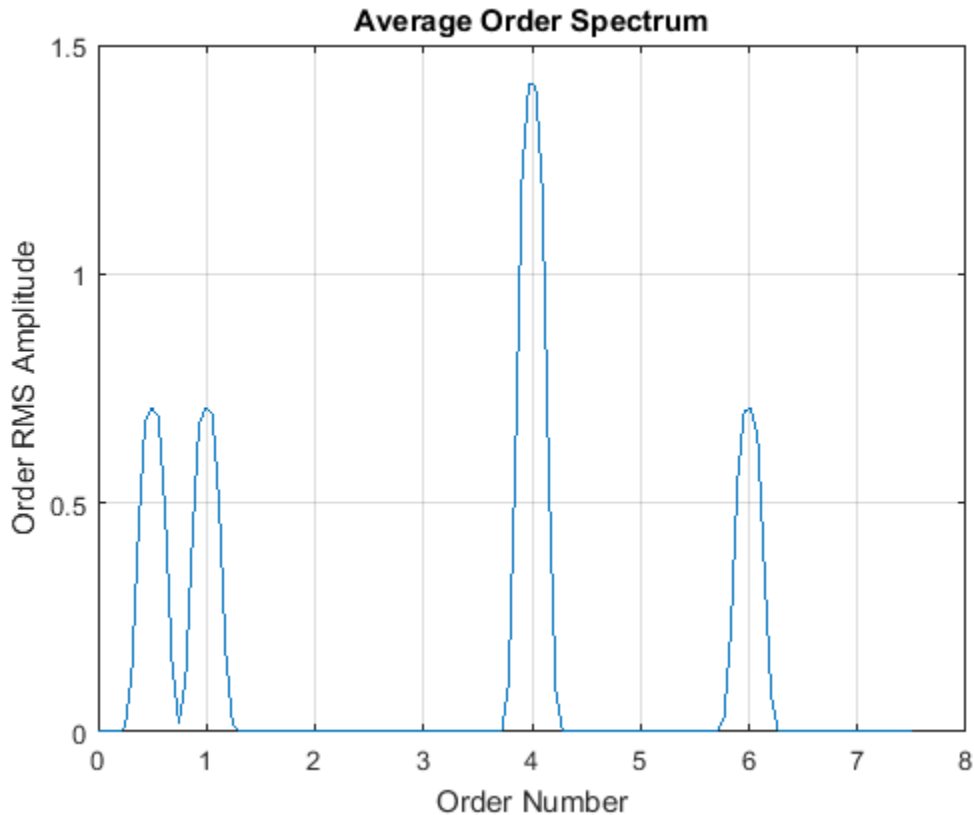

Average Order Spectrum of Helicopter Vibration Data

Analyze simulated data from an accelerometer placed in the cockpit of a helicopter.

Load the helicopter data. The vibrational measurements, `vib`, are sampled at a rate of 500 Hz for 10 seconds. The data has a linear trend. Remove the trend to prevent it from degrading the quality of the order estimation.

```
load('helidata.mat')
```

```
vib = detrend(vib);
```

Plot the nonlinear RPM profile. The rotor runs up until it reaches a maximum rotational speed of about 27,600 revolutions per minute and then coasts down.

```
plot(t,rpm)
xlabel('Time (s)')
ylabel('RPM')
```

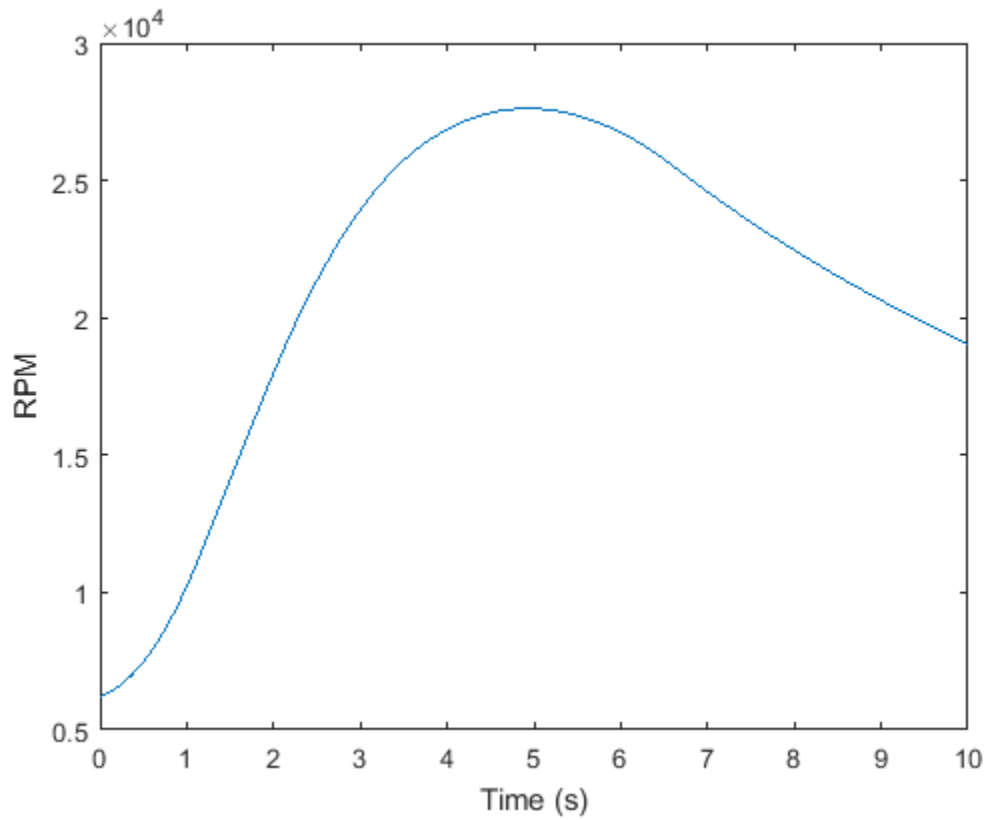

Compute the average order spectrum of the signal. Use the default order resolution.

```
orderspectrum(vib,fs,rpm)
```

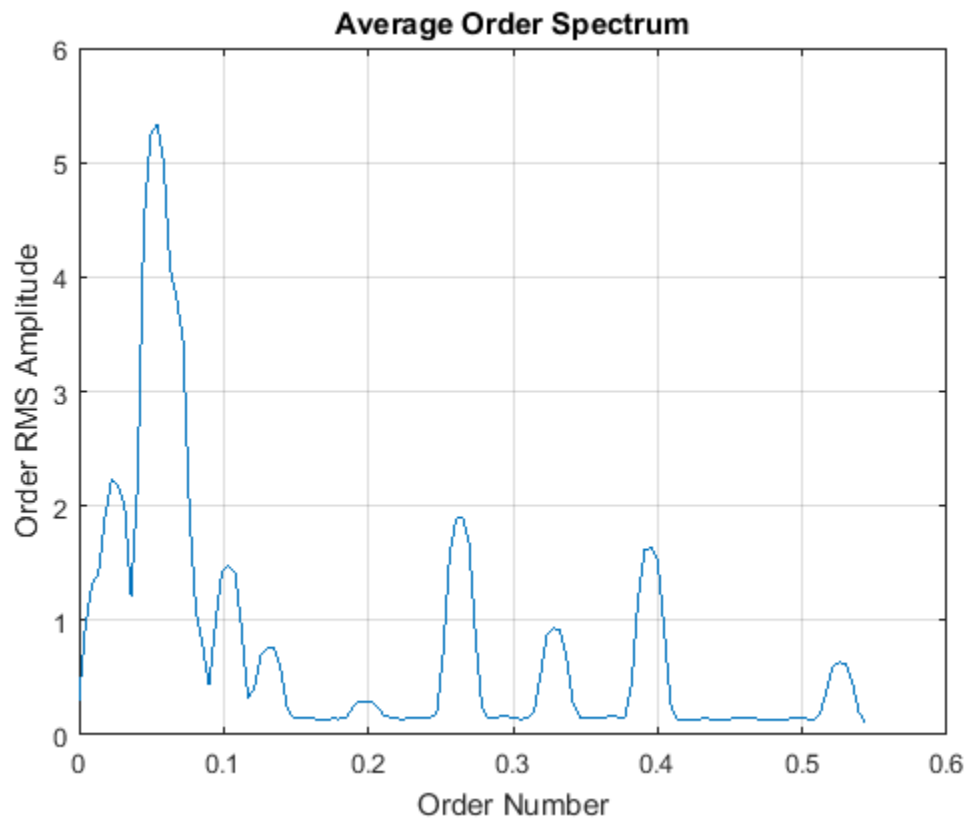

Use `rpmordermap` to repeat the computation with a finer order resolution. The lower orders are resolved more clearly.

```
[map,order] = rpmordermap(vib,fs,rpm,0.005);
```

```
orderspectrum(map,order)
```

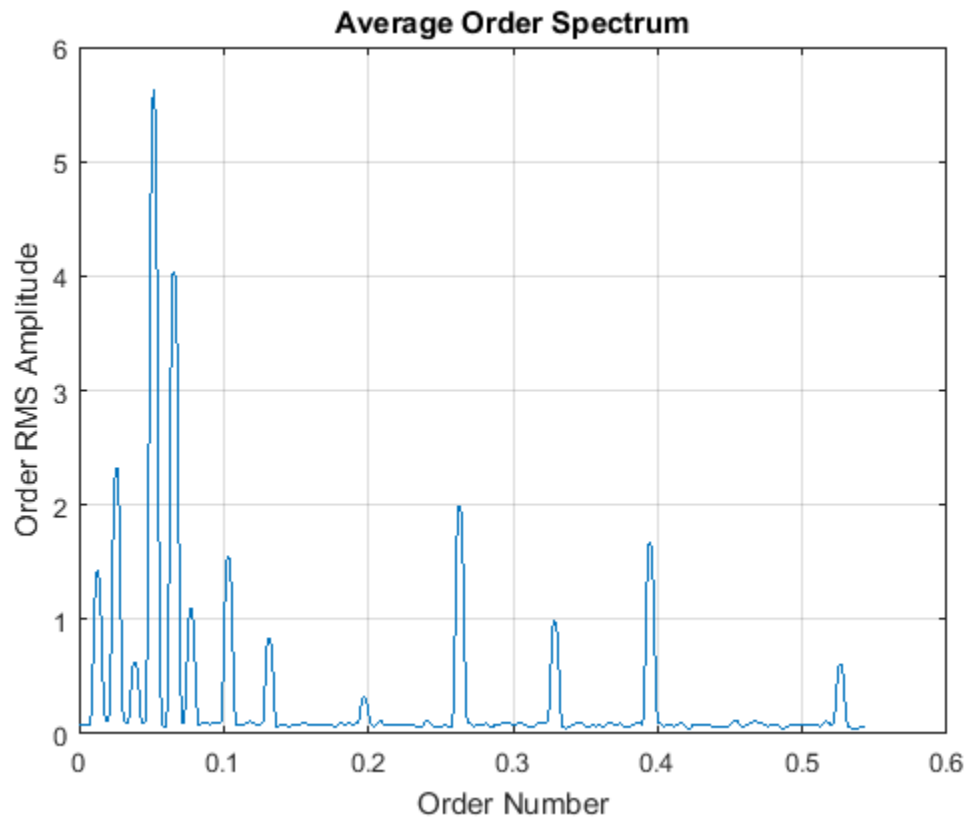

Compute the power level for each estimated order. Display the result in decibels.

```
[map,order] = rpmordermap(vib,fs,rpm,0.005,'Amplitude','power');  
spec = orderspectrum(map,order);  
  
plot(order,pow2db(spec))  
xlabel('Order Number')  
ylabel('Order Power Amplitude (dB)')  
grid on
```

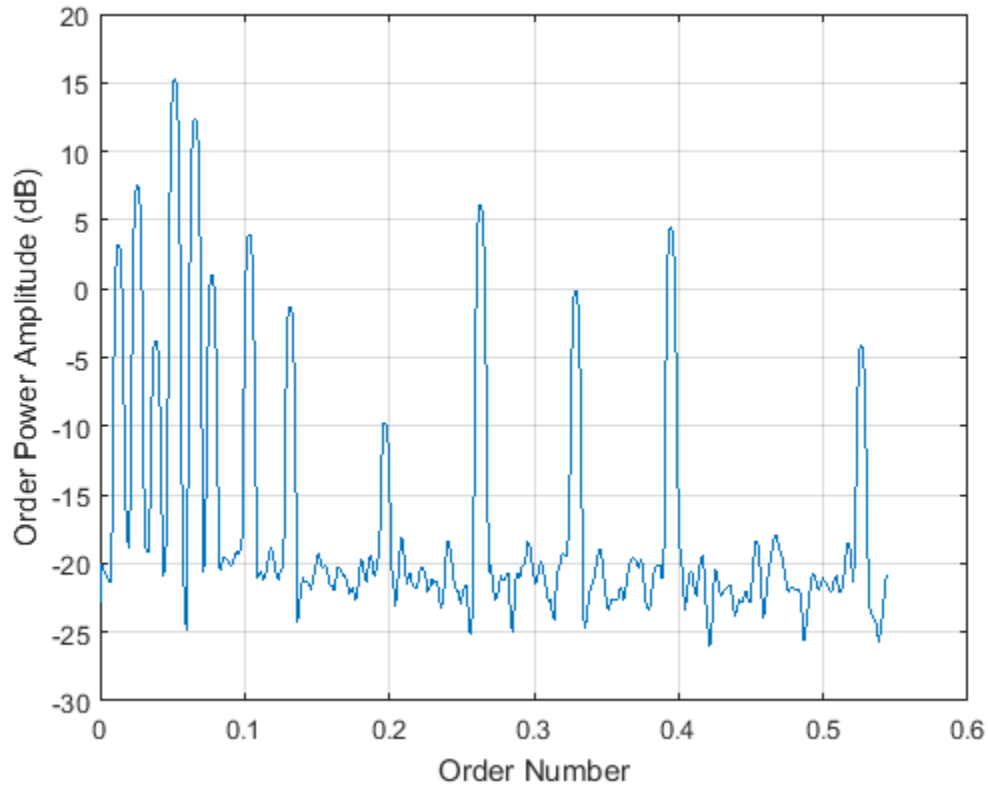

- “Order Analysis of a Vibration Signal”

Input Arguments

x — Input signal

vector

Input signal, specified as a row or column vector.

Example: `cos(pi/4*(0:159))+randn(1,160)` specifies a sinusoid embedded in white Gaussian noise.

Data Types: `double` | `single`

fs — Sample rate

positive scalar

Sample rate, specified as a positive scalar expressed in Hz.

Data Types: double | single

rpm — Rotational speeds

vector of positive values

Rotational speeds, specified as a vector of positive values expressed in revolutions per minute. `rpm` must have the same length as `x`.

Example: `100:10:3000` specifies that a system rotates initially at 100 revolutions per minute and runs up to 3000 revolutions per minute in increments of 10.

Data Types: double | single

map — Order-RPM map

matrix

Order-RPM map, specified as a matrix. Use `rpmordermap` to compute order-RPM maps.

Data Types: double | single

order — Orders in order-RPM map syntax

vector

Orders in order-RPM map syntax, specified as a vector. The length of `order` must equal the number of rows in `map`.

Data Types: double | single

Output Arguments

spec — Average order-magnitude spectrum

vector

Average order-magnitude spectrum, returned as a vector of root-mean-square (RMS) amplitudes in linear scale. If you use `map` and `order` as input arguments, and set 'Amplitude' to 'power' when using `rpmordermap` to compute `map`, then `orderspectrum` returns `spec` in power units.

order — Output orders

real vector

Output orders, returned as a real vector.

References

- [1] Brandt, Anders. *Noise and Vibration Analysis: Signal Analysis and Experimental Procedures*. Chichester, UK: John Wiley & Sons, 2011.
- [2] Vold, Håvard, and Jan Leuridan. “High Resolution Order Tracking at Extreme Slew Rates Using Kalman Tracking Filters.” *Shock and Vibration*. Vol. 2, 1995, pp.507–515.

See Also

See Also

`ordertrack` | `orderwaveform` | `rpmfreqmap` | `rpmordermap` | `tachorpm`

Topics

“Order Analysis of a Vibration Signal”

Introduced in R2016b

ordertrack

Track and extract order magnitudes from vibration signal

Syntax

```
mag = ordertrack(x,fs,rpm,orderlist)
[mag,rpm,time] = ordertrack(x,fs,rpm,orderlist)

[ ___ ] = ordertrack(x,fs,rpm,orderlist,rpmrefidx)
[ ___ ] = ordertrack(x,fs,rpm,orderlist,rpmrefidx,Name,Value)

[ ___ ] = ordertrack(map,order,rpm,time,orderlist)

ordertrack( ___ )
```

Description

`mag = ordertrack(x,fs,rpm,orderlist)` returns a matrix, `mag`, that contains time-dependent root-mean-square (RMS) amplitude estimates of a specified set of orders, `orderlist`, present in input signal `x`. `x` is measured at a set `rpm` of rotational speeds expressed in revolutions per minute. `fs` is the measurement sample rate in Hz.

`[mag,rpm,time] = ordertrack(x,fs,rpm,orderlist)` also returns vectors of RPM and time values corresponding to the columns of `mag`.

`[___] = ordertrack(x,fs,rpm,orderlist,rpmrefidx)` extracts order magnitudes using the first-order Vold-Kalman filter and returns any of the output arguments from previous syntaxes.

`[___] = ordertrack(x,fs,rpm,orderlist,rpmrefidx,Name,Value)` specifies further options for the Vold-Kalman tracking procedure using `Name,Value` pairs.

`[___] = ordertrack(map,order,rpm,time,orderlist)` computes a matrix of magnitude estimates starting from an order-RPM map, `map`, a vector of orders, `order`, and a vector of time instants, `time`. Use `rpmordermap` to compute `map, order,` and `time`. The returned amplitudes and scaling are the same as in `map`.

`ordertrack(___)` with no output arguments plots in the current figure the time-dependent orders and RPM values.

Examples

Order Magnitudes of Chirp with Four Orders

Create a simulated signal sampled at 600 Hz for 5 seconds. The system that is being tested increases its rotational speed from 10 to 40 revolutions per second (or, equivalently, from 600 to 2400 revolutions per minute) during the observation period.

Generate the tachometer readings.

```
fs = 600;  
t1 = 5;  
t = 0:1/fs:t1;
```

```
f0 = 10;  
f1 = 40;  
rpm = 60*linspace(f0,f1,length(t));
```

The signal consists of four harmonically related chirps with orders 1, 0.5, 4, and 6. The amplitudes of the chirps are 1, 1/2, $\sqrt{2}$, and 2, respectively. To generate the chirps, use the trapezoidal rule to express the phase as the integral of the rotational speed.

```
o1 = 1;  
o2 = 0.5;  
o3 = 4;  
o4 = 6;
```

```
a1 = 1;  
a2 = 0.5;  
a3 = sqrt(2);  
a4 = 2;
```

```
ph = 2*pi*cumtrapz(rpm/60)/fs;
```

```
x = [a1 a2 a3 a4]*cos([o1 o2 o3 o4]'*ph);
```

Extract and visualize the magnitudes of the orders.

```
ordertrack(x,fs,rpm,[o1 o2 o3 o4])
```

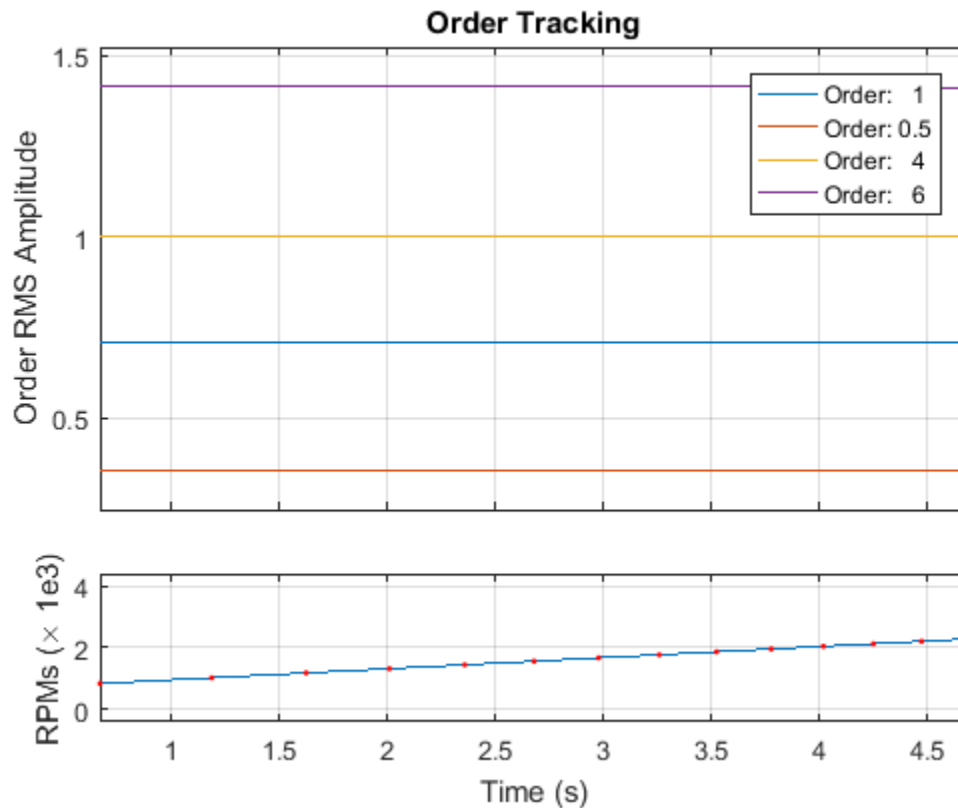

Track Crossing Orders

Create a simulated vibration signal consisting of two crossing orders corresponding to two different motors. The signal is sampled at 300 Hz for 3 seconds. The first motor increases its rotational speed from 10 to 100 revolutions per second (or, equivalently, from 600 to 6000 revolutions per minute) during the measurement. The second motor increases its rotational speed from 50 to 70 revolutions per second (or 3000 to 4200 revolutions per minute) during the same period.

```
fs = 300;
nsamp = 3*fs;
```

```
rpm1 = linspace(10,100,nsamp) '*60;
rpm2 = linspace(50,70,nsamp) '*60;
```

The measured signal is of order 1.2 and amplitude $2\sqrt{2}$ with respect to the first motor. With respect to the second motor, the signal is of order 0.8 and amplitude $4\sqrt{2}$.

```
x = [2 4]*sqrt(2).*cos(2*pi*cumtrapz([1.2*rpm1 0.8*rpm2]/60)/fs);
```

Make the first motor excite a resonance at the middle of the frequency range.

```
rs = [1+1./(1+linspace(-10,10,nsamp).^4)'/2 ones(nsamp,1)];
```

```
x = sum(rs.*x,2);
```

Visualize the orders using `rpmfreqmap`.

```
rpmfreqmap(x,fs,rpm1)
```

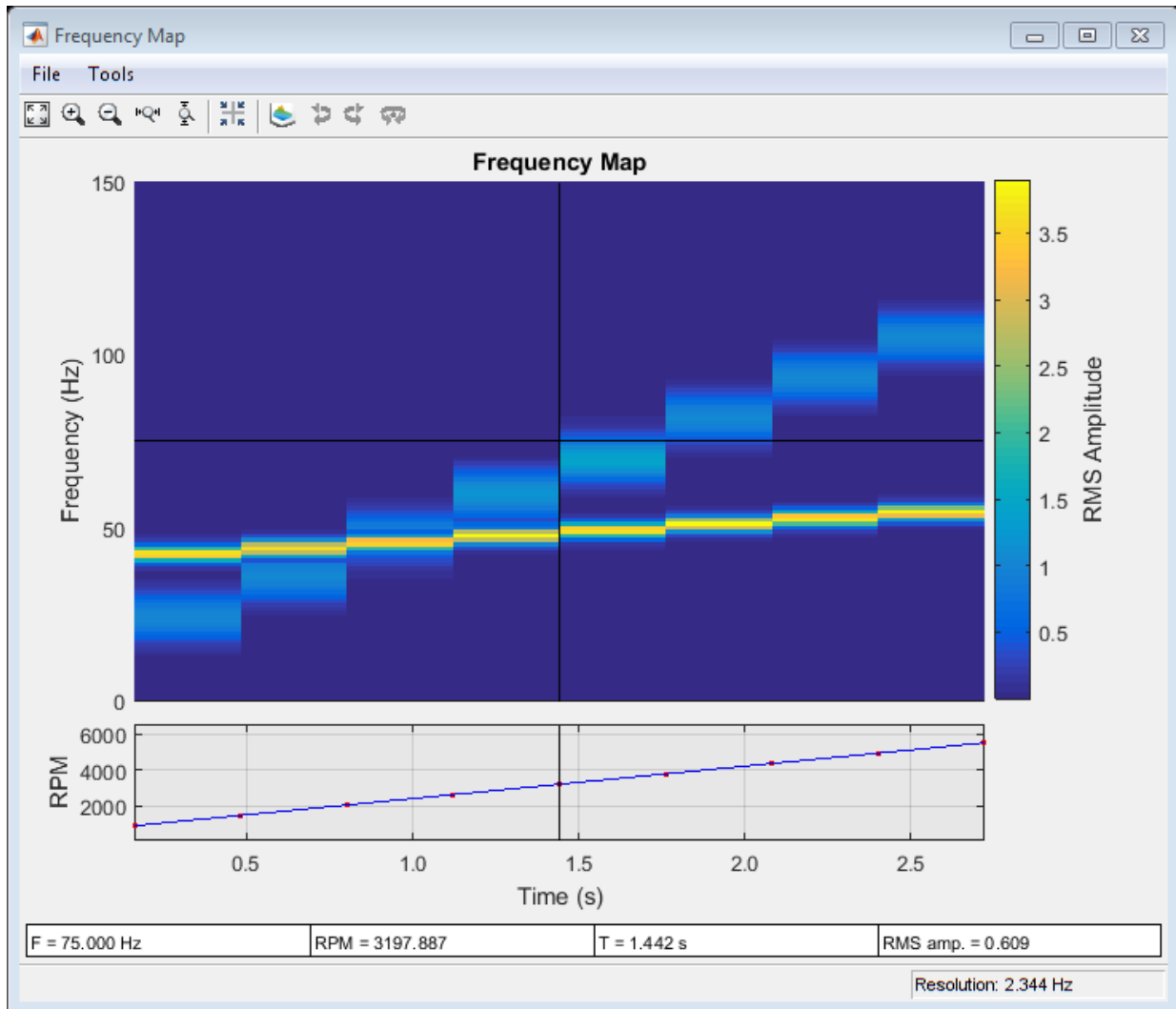

Compute the order magnitudes for both motors as a function of RPM. Use the Vold-Kalman algorithm to decouple the crossing orders.

```
ordertrack(x,fs,[rpm1 rpm2],[1.2 0.8],[1 2], 'Decouple', true)
```

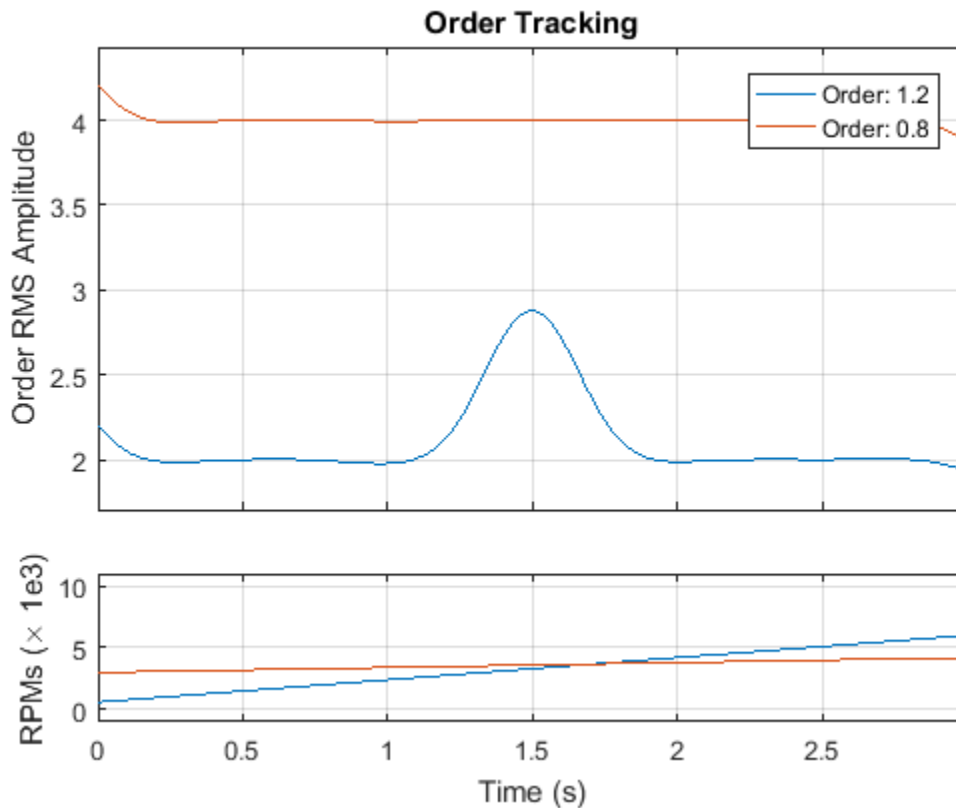

Track Orders of Helicopter Vibration Data

Analyze simulated data from an accelerometer placed in the cockpit of a helicopter.

Load the helicopter data. The vibrational measurements, `vib`, are sampled at a rate of 500 Hz for 10 seconds. Inspection of the data reveals that it has a linear trend. Remove the trend to prevent it from degrading the quality of the order estimation.

```
load('helidata.mat')
```

```
vib = detrend(vib);
```

Compute the order-RPM map. Specify an order resolution of 0.005.



```
[map,order,rpm,time,res] = rpmordermap(vib,fs,rpm,0.005);
```

Compute and plot the average order spectrum of the signal. Find the three highest peaks of the spectrum.

```
[spectrum,specorder] = orderspectrum(map,order);
```

```
[~,pkords] = findpeaks(spectrum,specorder, 'SortStr', 'descend', 'Npeaks', 3);
```

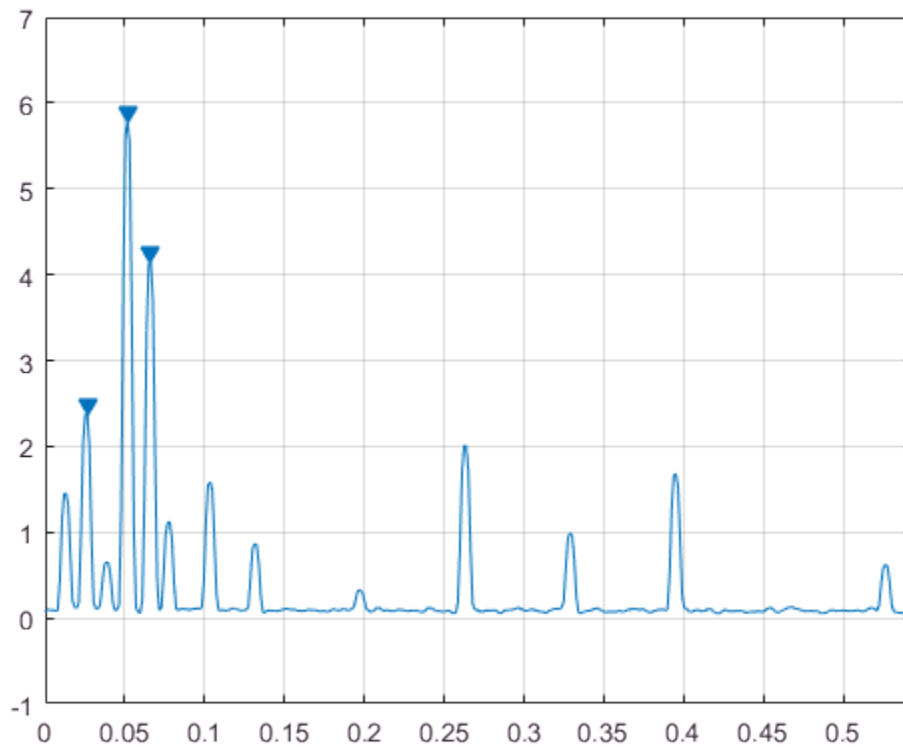
```
findpeaks(spectrum,specorder, 'SortStr', 'descend', 'Npeaks', 3)
```



Track the amplitudes of the three highest peaks.

```
ordertrack(map,order,rpm,time,pkords)
```

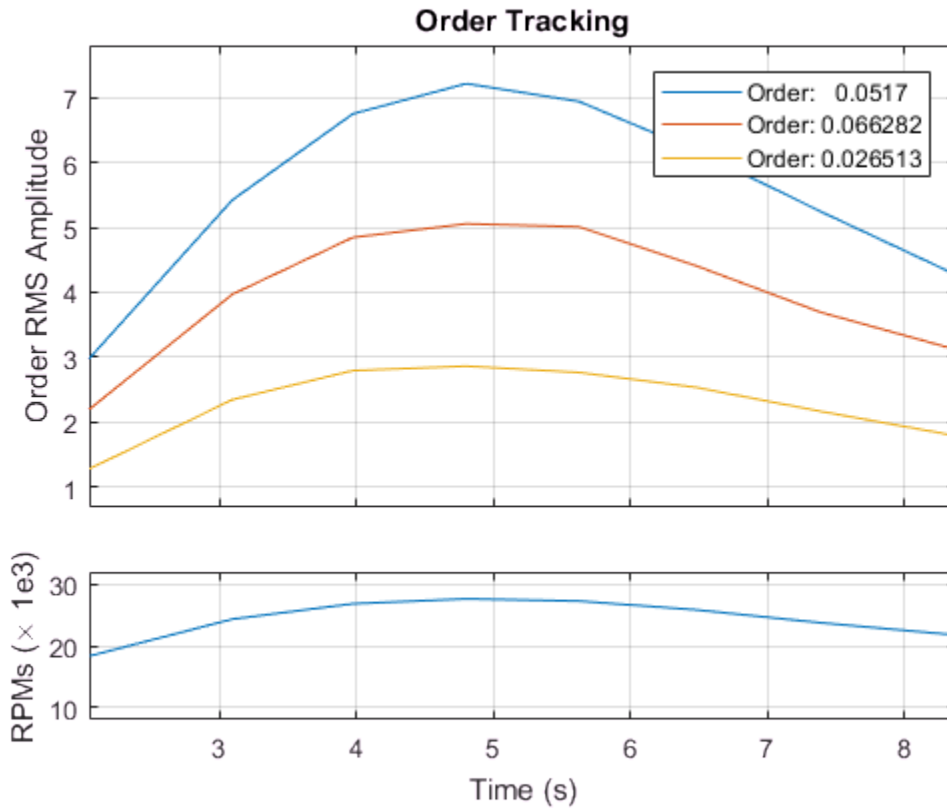

- “Order Analysis of a Vibration Signal”

Input Arguments

x — Input signal

vector

Input signal, specified as a row or column vector.

Example: `cos(pi/4*(0:159))+randn(1,160)` specifies a sinusoid embedded in white Gaussian noise.

Data Types: double | single

fs — Sample rate

positive scalar

Sample rate, specified as a positive scalar expressed in Hz.

Data Types: double | single

rpm — Rotational speeds

vector of positive values | matrix of positive values

Rotational speeds, specified as a vector or matrix of positive values expressed in revolutions per minute. If `rpm` is a vector, it must have the same length as `x`. If `rpm` is a matrix, and `rpmrefidx` is specified, then `rpm` must have at least two columns, and each column must have as many elements as `x`.

Example: `100:10:3000` specifies that a system rotates initially at 100 revolutions per minute and runs up to 3000 revolutions per minute in increments of 10.

Data Types: double | single

orderlist — List of orders

vector

List of orders, specified as a vector. `orderlist` must not have values larger than `fs/(2 × max(rpm/60))`.

Data Types: double | single

rpmrefidx — RPM column indices

vector

RPM column indices, specified as a vector of the same size as `orderlist`. The presence of this argument specifies that the Vold-Kalman algorithm is to be used.

Data Types: double | single

map — Order-RPM map

matrix

Order-RPM map, specified as a matrix. Use `rpmordermap` to compute order-RPM maps.

Data Types: double | single

order — Orders in order-RPM map syntax

vector

Orders in order-RPM map syntax, specified as a vector. The length of `order` must equal the number of rows in `map`.

Data Types: `double` | `single`**Name-Value Pair Arguments**

Specify optional comma-separated pairs of `Name`, `Value` arguments. `Name` is the argument name and `Value` is the corresponding value. `Name` must appear inside single quotes (`' '`). You can specify several name and value pair arguments in any order as `Name1, Value1, ..., NameN, ValueN`.

Example: `'Decouple', true, 'Amplitude', 'peak'` extracts the specified orders simultaneously and returns the peak amplitude of each order.

'Amplitude' — Amplitude type`'rms'` (default) | `'peak'` | `'power'`

Amplitude type, specified as the comma-separated pair consisting of `'Amplitude'` and one of `'rms'`, `'peak'`, or `'power'`.

- `'rms'` — Returns the root-mean-square amplitude for each estimated order.
- `'peak'` — Returns the peak amplitude for each estimated order.
- `'power'` — Returns the power level for each estimated order.

Data Types: `char`**'Scale' — Magnitude scaling**`'linear'` (default) | `'dB'`

Magnitude scaling, specified as the comma-separated pair consisting of `'Scale'` and either `'linear'` or `'dB'`.

- `'linear'` — Returns magnitude values scaled in linear units.
- `'dB'` — Returns magnitude values scaled logarithmically and expressed in decibels.

Data Types: `char`

'Bandwidth' — Approximate half-power bandwidth

fs/100 (default) | real scalar | real vector

Approximate half-power bandwidth, specified as the comma-separated pair consisting of 'Bandwidth' and either a real scalar or a real vector with the same number of elements as `orderlist`. Smaller values of 'Bandwidth' produce smooth, narrowband output. However, this output might not accurately reflect rapid changes in order amplitude.

Data Types: double | single

'Decouple' — Mode decoupling option

false (default) | true

Mode decoupling option, specified as the comma-separated pair consisting of 'Decouple' and a logical value. If this option is set to `true`, then `ordertrack` extracts order magnitudes simultaneously, enabling it to separate closely spaced or crossing orders.

Data Types: logical

'SegmentLength' — Length of overlapping segments

integer

Length of overlapping segments, specified as the comma-separated pair consisting of 'SegmentLength' and an integer. If you specify a segment length, then `ordertrack` divides the input signal into segments. It then computes the order magnitudes for each segment and combines the results to produce the output. If the segments are too short, the function might not properly capture localized events such as crossing orders.

Data Types: double | single

Output Arguments

mag — Order-magnitude matrix

matrix

Order-magnitude matrix, returned as a matrix.

rpm — Rotational speeds

vector of positive values

Rotational speeds, returned as a vector of positive values expressed in revolutions per minute.

time — Time instants

vector

Time instants, returned as a vector.

References

- [1] Brandt, Anders. *Noise and Vibration Analysis: Signal Analysis and Experimental Procedures*. Chichester, UK: John Wiley & Sons, 2011.
- [2] Feldbauer, Christian, and Robert Höldrich. “Realization of a Vold-Kalman Tracking Filter — A Least Squares Problem.” *Proceedings of the COST G-6 Conference on Digital Audio Effects (DAFX-00)*. Verona, Italy, December 7–9, 2000.
- [3] Vold, Håvard, and Jan Leuridan. “High Resolution Order Tracking at Extreme Slew Rates Using Kalman Tracking Filters.” *Shock and Vibration*. Vol. 2, 1995, pp.507–515.

See Also

See Also

orderspectrum | orderwaveform | rpmfreqmap | rpmordermap | tachorpm

Topics

“Order Analysis of a Vibration Signal”

Introduced in R2016b

orderwaveform

Extract time-domain order waveforms from vibration signal

Syntax

```
xrec = orderwaveform(x,fs,rpm,orderlist)
xrec = orderwaveform(x,fs,rpm,orderlist,rpmrefidx)
[ ___ ] = ordertrack(x,fs,rpm,orderlist,rpmrefidx,Name,Value)
```

Description

`xrec = orderwaveform(x,fs,rpm,orderlist)` returns the time-domain waveforms corresponding to a specified set of orders present in an input signal, `x`. `x` is measured at a set `rpm` of rotational speeds expressed in revolutions per minute. `fs` is the measurement sample rate in Hz. The vector `orderlist` specifies the desired orders, whose waveforms are returned in the corresponding columns of `xrec`. The function uses the Vold-Kalman filter for the computation.

`xrec = orderwaveform(x,fs,rpm,orderlist,rpmrefidx)` returns time-domain waveforms with multiple reference RPM signals, which are stored in the columns of `rpm`. `rpmrefidx` is a vector that relates each order in `orderlist` to an RPM signal.

`[___] = ordertrack(x,fs,rpm,orderlist,rpmrefidx,Name,Value)` specifies further options for the Vold-Kalman procedure using `Name,Value` pairs and either of the previous syntaxes.

Examples

Order Waveforms of Chirp with Four Orders

Create a simulated signal sampled at 600 Hz for 5 seconds. The system that is being tested increases its rotational speed from 10 to 40 revolutions per second (or, equivalently, from 600 to 2400 revolutions per minute) during the observation period.

Generate the tachometer readings.

```
fs = 600;
t1 = 5;
t = 0:1/fs:t1;

f0 = 10;
f1 = 40;
rpm = 60*linspace(f0,f1,length(t));
```

The signal consists of four harmonically related chirps with orders 1, $1/2$, $\sqrt{2}$, and 2. The amplitudes of the chirps are 1, $1/2$, $\sqrt{2}$, and 2, respectively. To generate the chirps, use the trapezoidal rule to express the phase as the integral of the rotational speed.

```
ord = [1 0.5 sqrt(2) 2];
amp = [1 0.5 sqrt(2) 2];

ph = 2*pi*cumtrapz(rpm/60)/fs;

x(1,:) = amp(1)*cos(ord(1)*ph);
x(2,:) = amp(2)*cos(ord(2)*ph);
x(3,:) = amp(3)*cos(ord(3)*ph);
x(4,:) = amp(4)*cos(ord(4)*ph);

xsum = sum(x);
```

Reconstruct the time-domain waveforms that compose the signal.

```
xrec = orderwaveform(xsum,fs,rpm,ord);
```

Visualize the results. Zoom in on a time interval occurring after the transients have decayed.

```
for kj = 1:4
    subplot(2,2,kj)
    plot(t,x(kj,:),t,xrec(:,kj))
    title(['Order = ' num2str(ord(kj))])
    xlim([2 3])
end
```

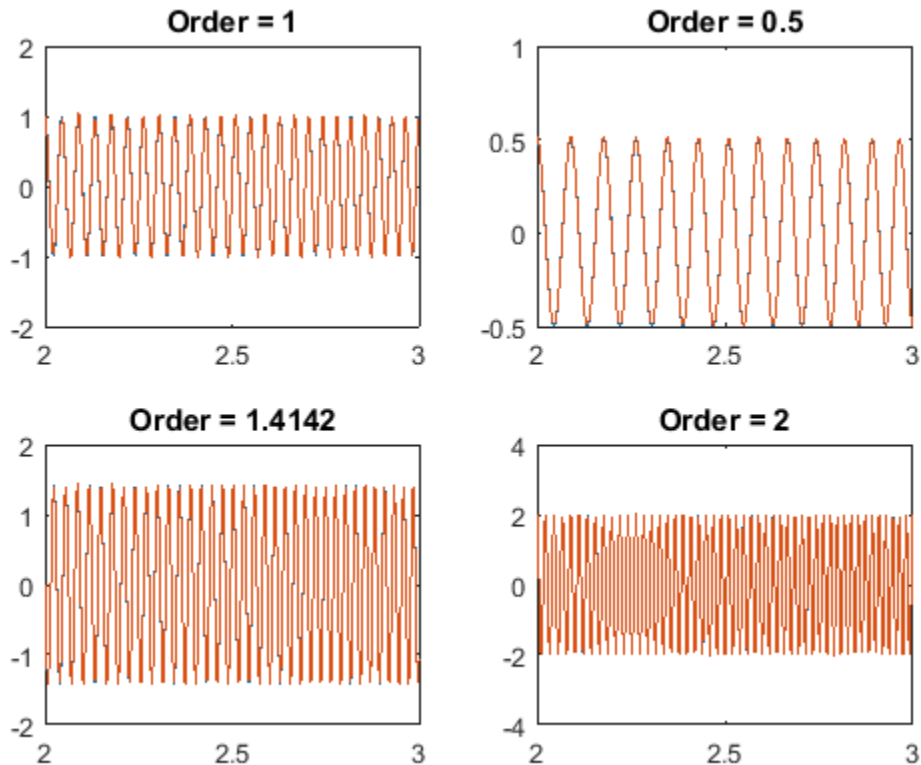
Extract Waveforms of Crossing Orders

Create a simulated vibration signal consisting of two crossing orders corresponding to two different motors. The signal is sampled at 300 Hz for 3 seconds. The first motor increases its rotational speed from 10 to 100 revolutions per second (or, equivalently, from 600 to 6000 rpm) during the measurement. The second motor increases its rotational speed from 50 to 70 revolutions per second (or 3000 to 4200 rpm) during the same period.

```
fs = 300;
nsamp = 3*fs;

rpm1 = linspace(10,100,nsamp) '*60;
rpm2 = linspace(50,70,nsamp) '*60;
```

The measured signal is of order 1.2 and amplitude $2\sqrt{2}$ with respect to the first motor. With respect to the second motor, the signal is of order 0.8 and amplitude $4\sqrt{2}$.

```
x = [2 4]*sqrt(2).*cos(2*pi*cumtrapz([1.2*rpm1 0.8*rpm2]/60)/fs);
```

Make the first motor excite a resonance at the middle of the frequency range.

```
y = [1+1./(1+linspace(-10,10,nsamp).^4)'/2 ones(nsamp,1)].*x;
```

```
x = sum(y,2);
```

Visualize the orders using `rpmfreqmap`.

```
rpmfreqmap(x,fs,rpm1)
```

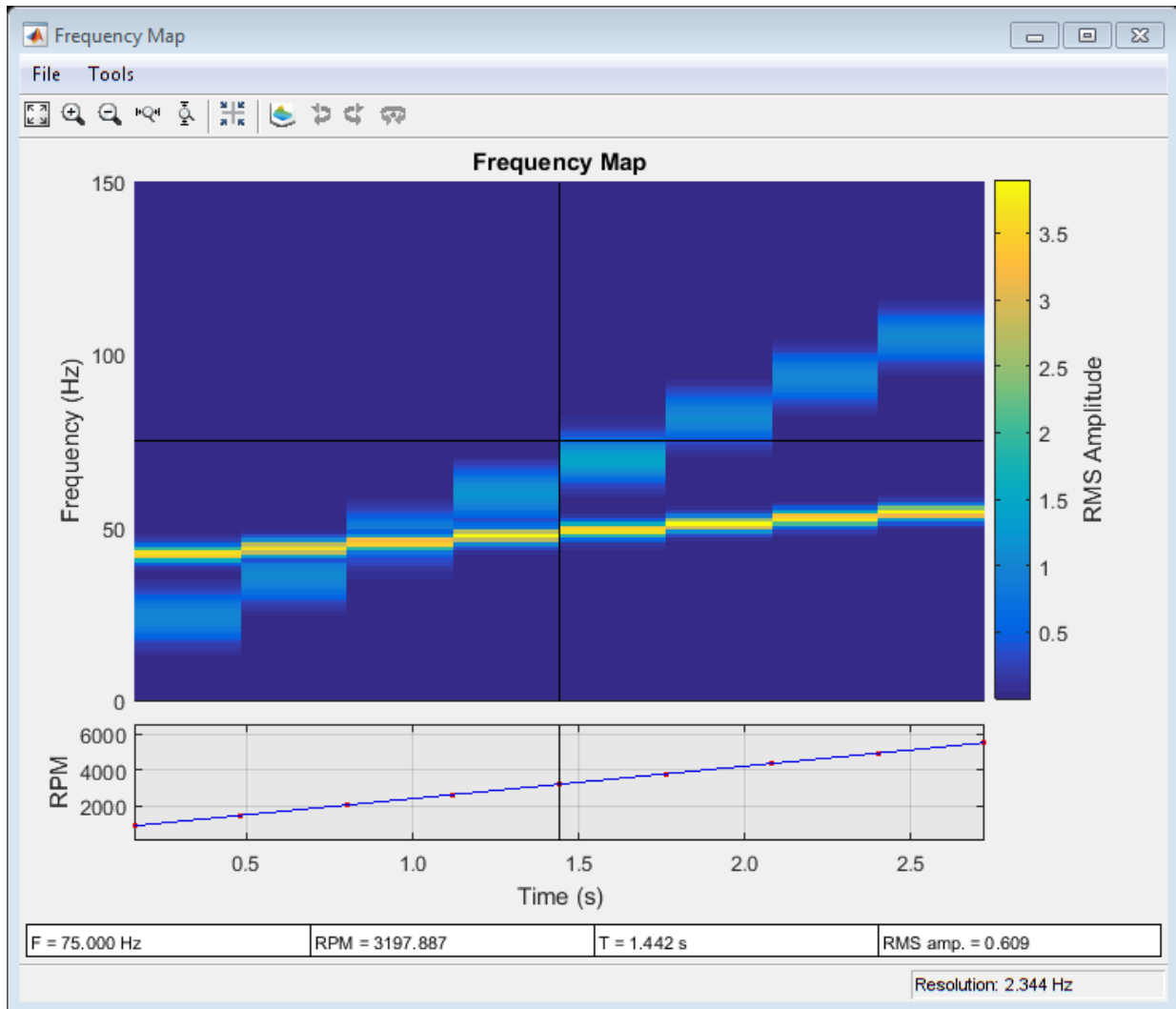

Reconstruct the time-domain waveforms that compose the signal. Use the Vold-Kalman algorithm to decouple the crossing orders.

```
xrec = orderwaveform(x,fs,[rpm1 rpm2],[1.2 0.8],[1 2],'Decouple',true);
```

Plot the original and reconstructed waveforms.

```
for kj = 1:2
    figure(kj)
    subplot(2,1,1)
    plot((0:nsamp-1)/fs,y(:,kj))
    legend('Original')
    title(['Motor ' int2str(kj)])
    subplot(2,1,2)
    plot((0:nsamp-1)/fs,xrec(:,kj))
    legend('Reconstructed')
end
```

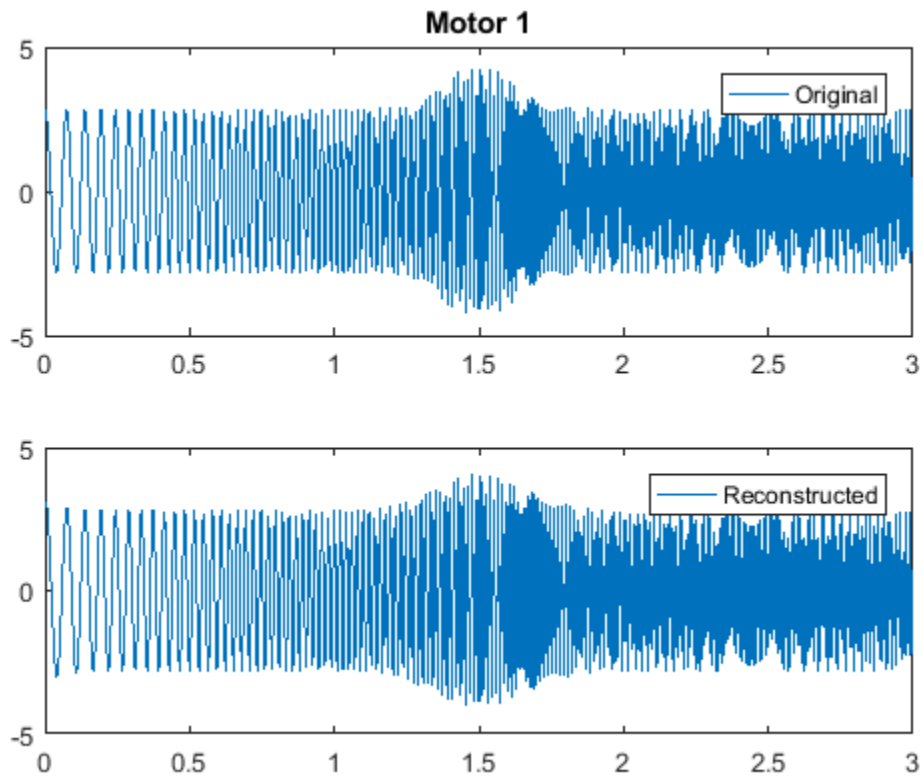

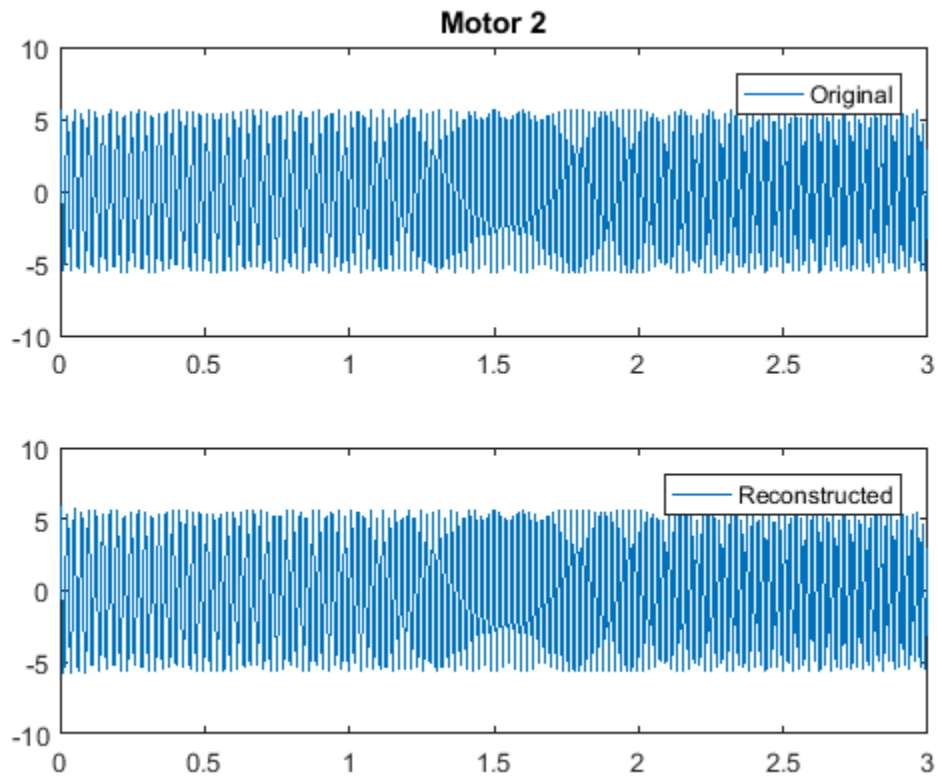

- “Order Analysis of a Vibration Signal”

Input Arguments

x — Input signal

vector

Input signal, specified as a row or column vector.

Example: `cos(pi/4*(0:159))+randn(1,160)` specifies a sinusoid embedded in white Gaussian noise.

Data Types: `double` | `single`

fs — Sample rate

positive scalar

Sample rate, specified as a positive scalar expressed in Hz.

Data Types: double | single

rpm — Rotational speeds

vector of positive values

Rotational speeds, specified as a vector of positive values expressed in revolutions per minute. `rpm` must have the same length as `x`.

Example: `100:10:3000` specifies that a system rotates initially at 100 revolutions per minute and runs up to 3000 revolutions per minute in increments of 10.

Data Types: double | single

orderlist — List of orders

vector

List of orders, specified as a vector. `orderlist` must not have values larger than $fs / (2 \times \max(\text{rpm}/60))$.

Data Types: double | single

rpmrefidx — RPM column indices

vector

RPM column indices, specified as a vector of the same size as `orderlist`.

Data Types: double | single

Name-Value Pair Arguments

Specify optional comma-separated pairs of `Name`, `Value` arguments. `Name` is the argument name and `Value` is the corresponding value. `Name` must appear inside single quotes (' '). You can specify several name and value pair arguments in any order as `Name1, Value1, ..., NameN, ValueN`.

Example: `'Decouple', true, 'FilterOrder', 2` extracts the specified order waveforms simultaneously and uses a second-order Vold-Kalman filter.

'FilterOrder' — Vold-Kalman filter order

1 (default) | 2

Vold-Kalman filter order, specified as the comma-separated pair consisting of `'FilterOrder'` and either 1 or 2.

Data Types: `double` | `single`

'Bandwidth' — Approximate half-power bandwidth

`fs/100` (default) | real scalar | real vector

Approximate half-power bandwidth, specified as the comma-separated pair consisting of `'Bandwidth'` and either a real scalar or a real vector with the same number of elements as `orderlist`. Smaller values of `'Bandwidth'` produce smooth, narrowband output. However, this output might not accurately reflect rapid changes in order amplitude.

Data Types: `double` | `single`

'Decouple' — Mode decoupling option

`false` (default) | `true`

Mode decoupling option, specified as the comma-separated pair consisting of `'Decouple'` and a logical value. If this option is set to `true`, then `orderwaveform` extracts order waveforms simultaneously, enabling it to separate closely spaced or crossing orders.

Data Types: `logical`

'SegmentLength' — Length of overlapping segments

integer

Length of overlapping segments, specified as the comma-separated pair consisting of `'SegmentLength'` and an integer. If you specify a segment length, then `orderwaveform` divides the input signal into segments. It then computes the reconstructed waveforms for each segment and combines the results to produce the output. If the segments are too short, the function might not properly capture localized events such as crossing orders.

Data Types: `double` | `single`

Output Arguments

`xrec` — Reconstructed time-domain order waveforms

matrix

Reconstructed time-domain order waveforms, returned as a matrix with one waveform in each column.

References

- [1] Feldbauer, Christian, and Robert Höldrich. “Realization of a Vold-Kalman Tracking Filter — A Least Squares Problem.” *Proceedings of the COST G-6 Conference on Digital Audio Effects (DAFX-00)*. Verona, Italy, December 7–9, 2000.
- [2] Vold, Håvard, and Jan Leuridan. “High Resolution Order Tracking at Extreme Slew Rates Using Kalman Tracking Filters.” *Shock and Vibration*. Vol. 2, 1995, pp.507–515.

See Also

See Also

`orderspectrum` | `ordertrack` | `rpmfreqmap` | `rpmordermap` | `tachorpm`

Topics

“Order Analysis of a Vibration Signal”

Introduced in R2016b

overshoot

Overshoot metrics of bilevel waveform transitions

Syntax

```
OS = overshoot(X)
OS = overshoot(X,FS)
OS = overshoot(X,T)
[OS,OSLEV,OSINST] = overshoot(...)
[...] = overshoot(...,Name,Value)
overshoot(...)
```

Description

`OS = overshoot(X)` returns the greatest absolute deviations larger than the final state levels of each transition in the bilevel waveform, `X`. The overshoots, `OS`, are expressed as a percentage of the difference between the state levels. The length of `OS` corresponds to the number of transitions detected in the input signal. The sample instants in `X` correspond to the vector indices. To determine the transitions, `overshoot` estimates the state levels of the input waveform by a histogram method. `overshoot` identifies all intervals which cross the upper-state boundary of the low state and the lower-state boundary of the high state. The low-state and high-state boundaries are expressed as the state level plus or minus a multiple of the difference between the state levels. See “State-Level Tolerances” on page 1-1403.

`OS = overshoot(X,FS)` specifies the sampling frequency in hertz. The sampling frequency determines the sample instants corresponding to the elements in `X`. The first sample instant in `X` corresponds to $t=0$.

`OS = overshoot(X,T)` specifies the sample instants, `T`, as a vector with the same number of elements as `X`.

`[OS,OSLEV,OSINST] = overshoot(...)` returns the levels, `OSLEV`, and sample instants, `OSINST`, of the overshoots for each transition.

`[...] = overshoot(...,Name,Value)` returns the greatest deviations larger than the final state level with additional options specified by one or more `Name, Value` pair arguments.

`overshoot(...)` plots the bilevel waveform and marks the location of the overshoot of each transition as well as the lower and upper reference-level instants and the associated reference levels. The state levels and associated lower and upper-state boundaries are also plotted.

Input Arguments

X

Bilevel waveform. *X* is a real-valued row or column vector.

FS

Sample rate in hertz.

T

Vector of sample instants. The length of *T* must equal the length of the bilevel waveform, *X*.

Name-Value Pair Arguments

'PercentReferenceLevels'

Reference levels as a percentage of the waveform amplitude. The lower-state level is defined to be 0 percent. The upper-state level is defined to be 100 percent. The value of `'PercentReferenceLevels'` is a two-element real row vector whose elements correspond to the lower and upper percent reference levels.

Default: [10 90]

'Region'

Specifies the region over which to compute the overshoot. Valid values for `'Region'` are `'Preshoot'` or `'Postshoot'`. If you specify `'Preshoot'`, the end of the pretransition aberration region is defined as the last instant where the signal exits the first state. If you specify `'Postshoot'`, the start of the posttransition aberration region is defined as the instant when the signal enters the second state.

Default: `'Postshoot'`

'SeekFactor'

Aberration region duration. Specifies the duration of the region over which to compute the overshoot for each transition as a multiple of the corresponding transition duration. If the edge of the waveform is reached, or a complete intervening transition is detected before the duration aberration region duration elapses, the duration is truncated to the edge of the waveform or the start of the intervening transition.

Default: 3

'StateLevels'

Lower and upper state levels. Specifies the levels to use for the lower and upper state levels as a two-element real row vector whose first and second elements correspond to the lower and upper state levels of the input waveform.

'Tolerance'

Specifies the tolerance that the initial and final levels of each transition must be within the respective state levels. The **'Tolerance'** value is a scalar expressed as the percentage of the difference between the upper and lower state levels.

Default: 2

Output Arguments

OS

Overshoots expressed as a percentage of the state levels. The overshoot percentages are computed based on the greatest deviation from the final state level in each transition. By default overshoots are computed for posttransition aberration regions. See “Overshoot” on page 1-1402.

OSLEV

Level of the pretransition or posttransition overshoot.

OSINST

Sample instants of pretransition or posttransition overshoots. If you specify the sampling frequency or sampling instants, the overshoot instants are in seconds. If you do not

specify the sampling frequency or sampling instants, the overshoot instants are the indices of the input vector.

Examples

Overshoot Percentage in Posttransition Aberration Region

Determine the maximum percent overshoot relative to the high-state level in a 2.3 V clock waveform.

Load the 2.3 V clock data. Determine the maximum percent overshoot of the transition. Determine also the level and sample instant of the overshoot. In this example, the maximum overshoot in the posttransition region occurs near index 22.

```
load('transitionex.mat','x')
```

```
[oo,lv,nst] = overshoot(x)
```

```
oo = 6.1798
```

```
lv = 2.4276
```

```
nst = 22
```

Plot the waveform. Annotate the overshoot and the corresponding sample instant.

```
overshoot(x);
```

```
ax = gca;
```

```
ax.XTick = sort([ax.XTick nst]);
```

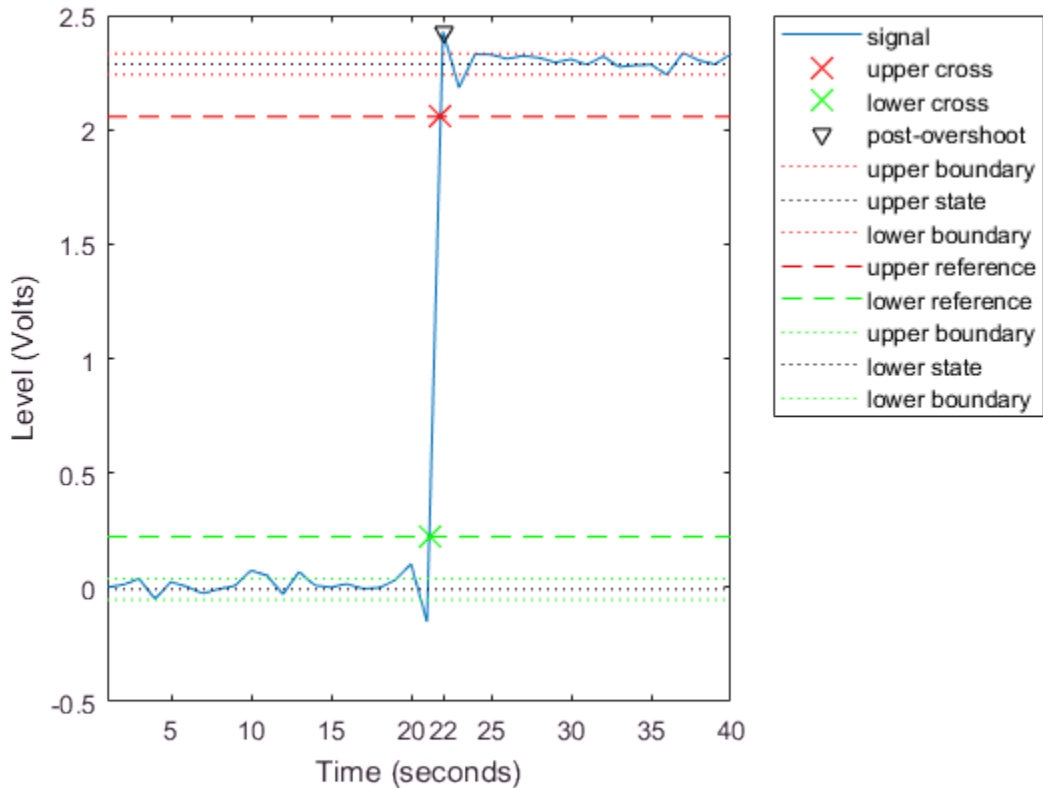

Overshoot Percentage, Levels, and Time Instant in Posttransition Aberration Region

Determine the maximum percent overshoot relative to the high-state level, the level of the overshoot, and the sample instant in a 2.3 V clock waveform.

Load the 2.3 V clock data with sampling instants. The clock data are sampled at 4 MHz.

```
load('transitionex.mat','x','t')
```

Determine the maximum percent overshoot, the level of the overshoot in volts, and the time instant where the maximum overshoot occurs. Plot the result.

```
[os,oslev,osinst] = overshoot(x,t)
```

```

os = 6.1798
oslev = 2.4276
osinst = 5.2500e-06

overshoot(x,t);

```

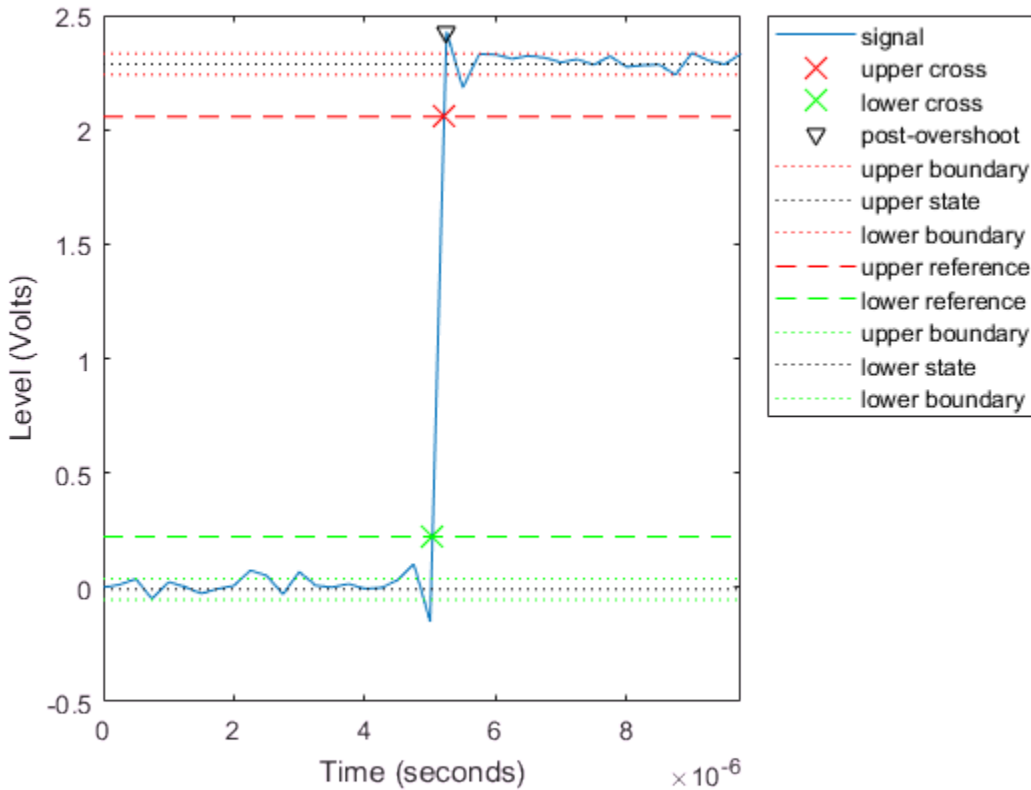

Overshoot Percentage, Levels, and Time Instant in Pretransition Aberration Region

Determine the maximum percent overshoot relative to the low-state level, the level of the overshoot, and the sample instant in a 2.3 V clock waveform. Specify the 'Region' as 'Preshoot' to output pretransition metrics.

Load the 2.3 V clock data with sampling instants. The clock data are sampled at 4 MHz.

```
load('transitionex.mat','x','t')
```

Determine the maximum percent overshoot, the level of the overshoot in volts, and the sampling instant where the maximum overshoot occurs. Plot the result.

```
[os,oslev,osinst] = overshoot(x,t,'Region','Preshoot')
```

```
os = 4.8050
```

```
oslev = 0.1020
```

```
osinst = 4.7500e-06
```

```
overshoot(x,t,'Region','Preshoot');
```

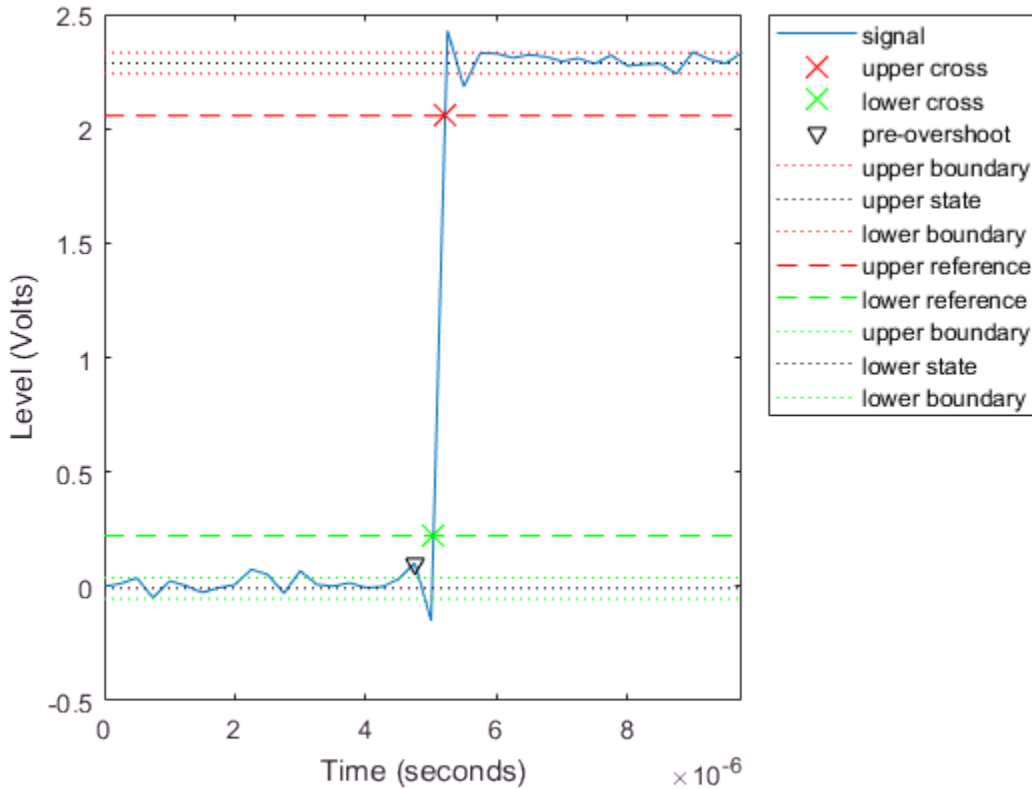

Definitions

Overshoot

For a positive-going (positive-polarity) pulse, overshoot expressed as a percentage is

$$100 \frac{(O - S_2)}{(S_2 - S_1)}$$

where O is the maximum deviation greater the high-state level, S_2 is the high state, and S_1 is the low state.

For a negative-going (negative-polarity) pulse, overshoot expressed as a percentage is

$$100 \frac{(O - S_1)}{(S_2 - S_1)}$$

The following figure illustrates the calculation of overshoot for a positive-going transition.

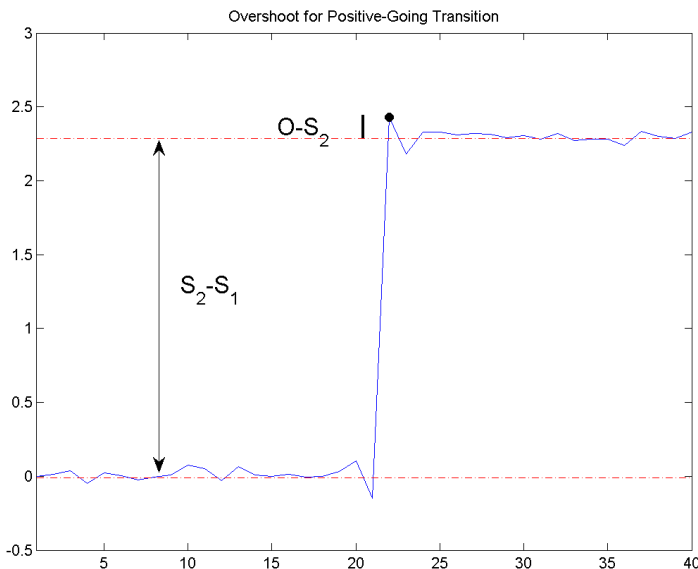

The red dashed lines indicate the estimated state levels. The double-sided black arrow depicts the difference between the high and low-state levels. The solid black line indicates the difference between the overshoot value and the high-state level.

State-Level Tolerances

Each state level can have associated lower- and upper-state boundaries. These state boundaries are defined as the state level plus or minus a scalar multiple of the difference

between the high state and the low state. To provide a useful tolerance region, the scalar is typically a small number such as 2/100 or 3/100. In general, the $\alpha\%$ region for the low state is defined as

$$S_1 \pm \frac{\alpha}{100}(S_2 - S_1),$$

where S_1 is the low-state level and S_2 is the high-state level. Replace the first term in the equation with S_2 to obtain the $\alpha\%$ tolerance region for the high state.

The following figure illustrates lower and upper 2% state boundaries (tolerance regions) for a positive-polarity bilevel waveform. The red dashed lines indicate the estimated state levels.

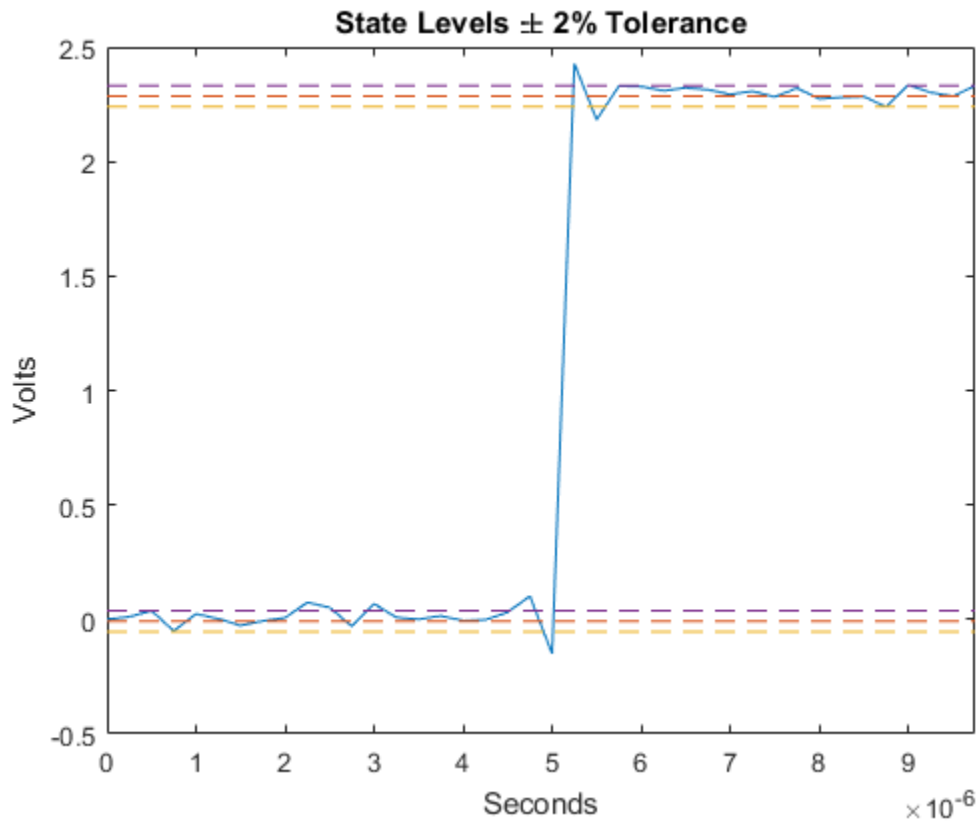

References

- [1] *IEEE Standard on Transitions, Pulses, and Related Waveforms*, IEEE Standard 181, 2003, pp. 15–17.

See Also

See Also

overshoot | settlingtime | statelevels

Introduced in R2012a

parzenwin

Parzen (de la Vallée Poussin) window

Syntax

```
w = parzenwin(L)
```

Description

`w = parzenwin(L)` returns the L-point Parzen (de la Vallée Poussin) window in a column vector, `w`. Parzen windows are piecewise-cubic approximations of Gaussian windows. Parzen window sidelobes fall off as $1/\omega^4$. See “Algorithms” on page 1-1408 for the equation that defines the Parzen window.

Examples

Parzen and Gaussian Windows

Compare 64-point Parzen and Gaussian windows. Display the result using `wvtool`.

```
gw = gausswin(64);  
pw = parzenwin(64);  
wvtool(gw,pw)
```

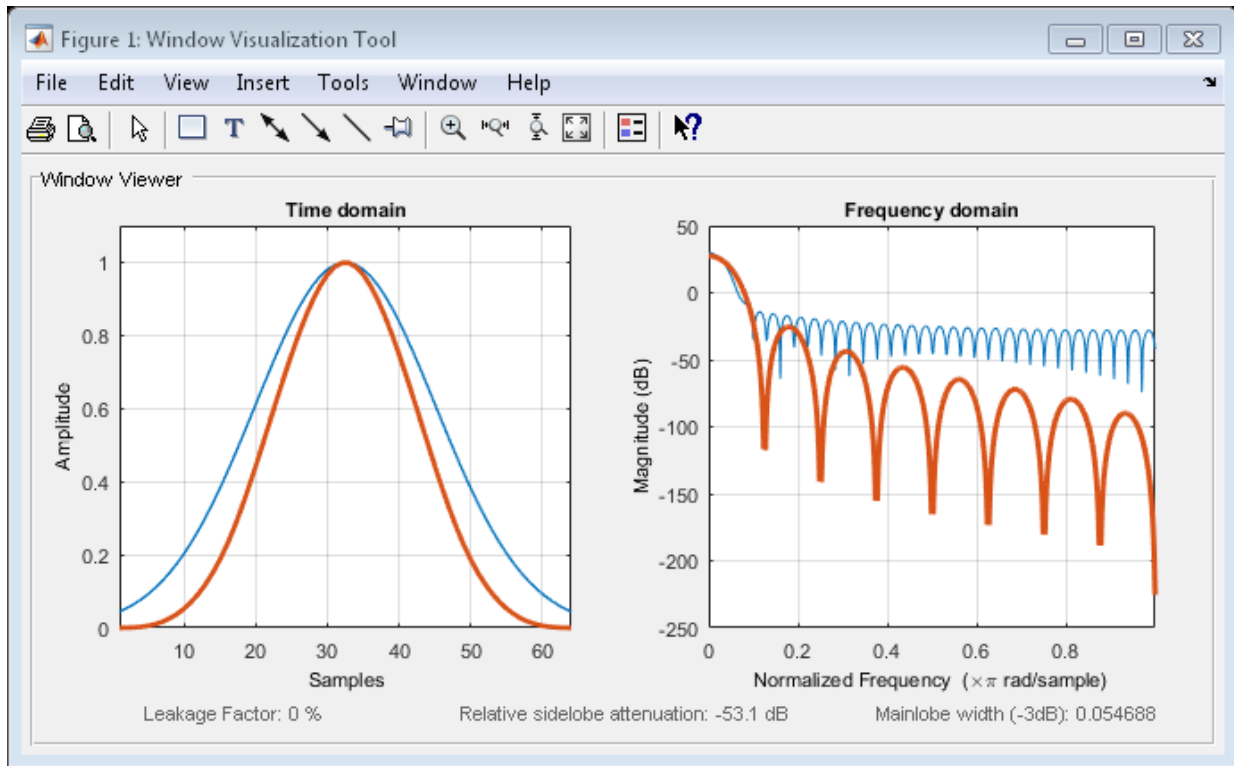

Algorithms

The following equation defines the N -point Parzen window over the interval

$$-\frac{(N-1)}{2} \leq n \leq \frac{(N-1)}{2} :$$

$$w(n) = \begin{cases} 1 - 6\left(\frac{|n|}{N/2}\right)^2 + 6\left(\frac{|n|}{N/2}\right)^3 & 0 \leq |n| \leq (N-1)/4 \\ 2\left(1 - \frac{|n|}{N/2}\right)^3 & (N-1)/4 < |n| \leq (N-1)/2 \end{cases}$$

References

- [1] Harris, Fredric J. “On the Use of Windows for Harmonic Analysis with the Discrete Fourier Transform.” *Proceedings of the IEEE*. Vol. 66, January 1978, pp. 51–83.

Extended Capabilities

C/C++ Code Generation

Generate C and C++ code using MATLAB® Coder™.

Usage notes and limitations:

All inputs must be constant. Expressions or variables are allowed if their values do not change.

See Also

See Also

Apps

Window Designer

Functions

barthannwin | bartlett | blackmanharris | bohmanwin | nuttallwin | rectwin
| triang | window | wvtool

Introduced before R2006a

pburg

Autoregressive power spectral density estimate — Burg's method

Syntax

```
pxx = pburg(x,order)
pxx = pburg(x,order,nfft)

[pxx,w] = pburg( ___ )
[pxx,f] = pburg( ___ ,fs)

[pxx,w] = pburg(x,order,w)
[pxx,f] = pburg(x,order,f,fs)

[ ___ ] = pburg(x,order, ___ ,freqrange)

[ ___ ,pxxc] = pburg( ___ ,'ConfidenceLevel',probability)

pburg( ___ )
```

Description

`pxx = pburg(x,order)` returns the power spectral density (PSD) estimate, `pxx`, of a discrete-time signal, `x`, found using Burg's method. When `x` is a vector, it is treated as a single channel. When `x` is a matrix, the PSD is computed independently for each column and stored in the corresponding column of `pxx`. `pxx` is the distribution of power per unit frequency. The frequency is expressed in units of rad/sample. `order` is the order of the autoregressive (AR) model used to produce the PSD estimate.

`pxx = pburg(x,order,nfft)` uses `nfft` points in the discrete Fourier transform (DFT). For real `x`, `pxx` has length $(nfft/2+1)$ if `nfft` is even, and $(nfft+1)/2$ if `nfft` is odd. For complex-valued `x`, `pxx` always has length `nfft`. If you omit `nfft`, or specify it as empty, then `pburg` uses a default DFT length of 256.

`[pxx,w] = pburg(___)` returns the vector of normalized angular frequencies, `w`, at which the PSD is estimated. `w` has units of rad/sample. For real-valued signals, `w` spans the interval $[0,\pi]$ when `nfft` is even and $[0,\pi)$ when `nfft` is odd. For complex-valued signals, `w` always spans the interval $[0,2\pi)$.

`[pxx,f] = pburg(____, fs)` returns a frequency vector, `f`, in cycles per unit time. The sampling frequency, `fs`, is the number of samples per unit time. If the unit of time is seconds, then `f` is in cycles/second (Hz). For real-valued signals, `f` spans the interval `[0,fs/2]` when `nfft` is even and `[0,fs/2)` when `nfft` is odd. For complex-valued signals, `f` spans the interval `[0,fs)`.

`[pxx,w] = pburg(x,order,w)` returns the two-sided AR PSD estimates at the normalized frequencies specified in the vector, `w`. The vector, `w`, must contain at least two elements.

`[pxx,f] = pburg(x,order,f,fs)` returns the two-sided AR PSD estimates at the frequencies specified in the vector, `f`. The vector, `f`, must contain at least two elements. The frequencies in `f` are in cycles per unit time. The sampling frequency, `fs`, is the number of samples per unit time. If the unit of time is seconds, then `f` is in cycles/second (Hz).

`[____] = pburg(x,order, ____, freqrange)` returns the AR PSD estimate over the frequency range specified by `freqrange`. Valid options for `freqrange` are: `'onesided'`, `'twosided'`, or `'centered'`.

`[____,pxxc] = pburg(____, 'ConfidenceLevel',probability)` returns the `probability` × 100% confidence intervals for the PSD estimate in `pxxc`.

`pburg(____)` with no output arguments plots the AR PSD estimate in dB per unit frequency in the current figure window.

Examples

Burg PSD Estimate of an AR(4) Process

Create a realization of an AR(4) wide-sense stationary random process. Estimate the PSD using Burg's method. Compare the PSD estimate based on a single realization to the true PSD of the random process.

Create an AR(4) system function. Obtain the frequency response and plot the PSD of the system.

```
A = [1 -2.7607 3.8106 -2.6535 0.9238];
[H,F] = freqz(1,A,[],1);
plot(F,20*log10(abs(H)))
```

```
xlabel('Frequency (Hz)')  
ylabel('PSD (dB/Hz)')
```

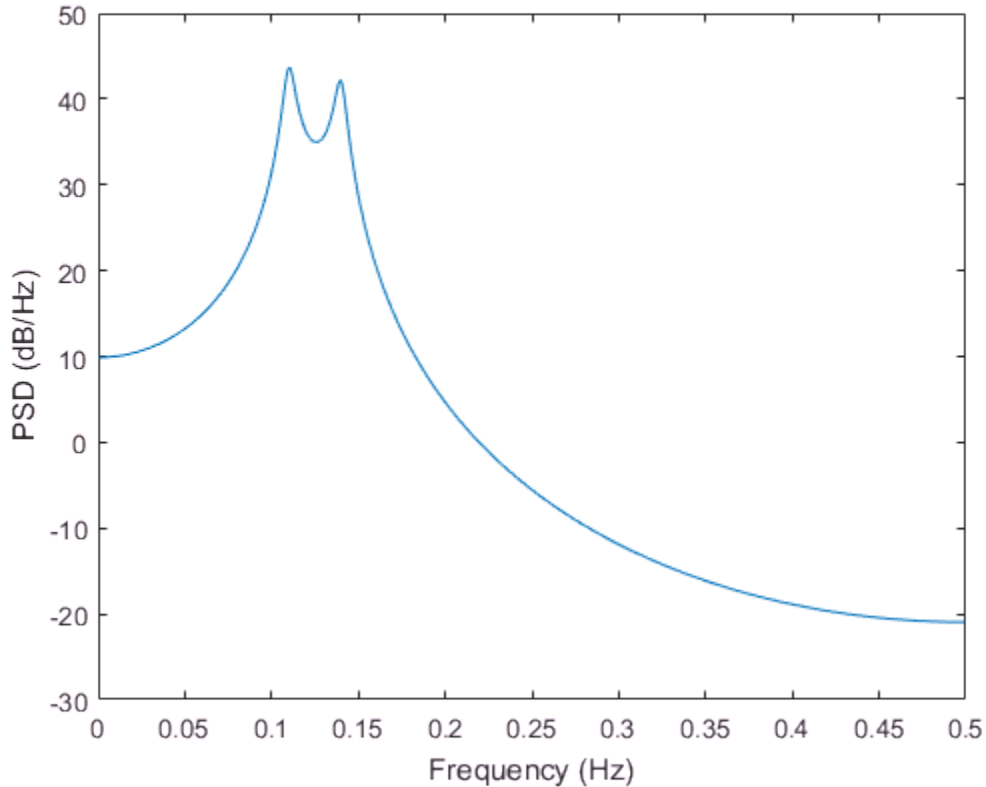

Create a realization of the AR(4) random process. Set the random number generator to the default settings for reproducible results. The realization is 1000 samples in length. Assume a sampling frequency of 1 Hz. Use `pburg` to estimate the PSD for a 4th-order process. Compare the PSD estimate with the true PSD.

```
rng default  
  
x = randn(1000,1);  
y = filter(1,A,x);  
[Pxx,F] = pburg(y,4,1024,1);
```

```

hold on
plot(F, 10*log10(Pxx))
legend('True Power Spectral Density', 'pburg PSD Estimate')

```

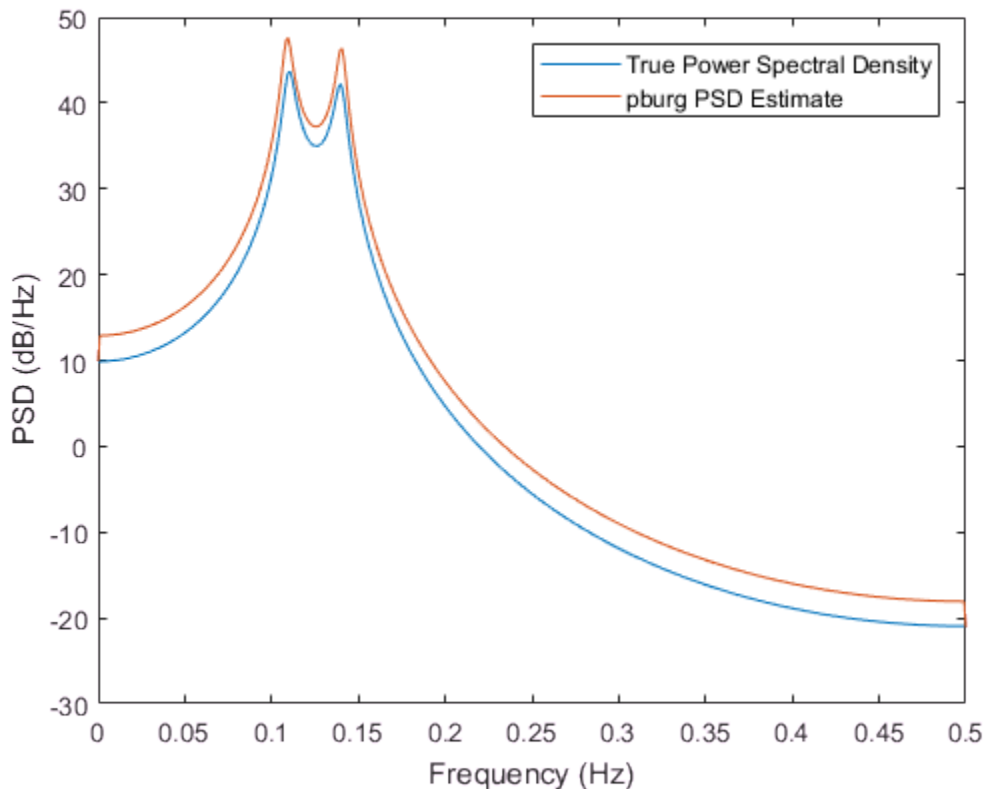

Reflection Coefficients for Model Order Determination

Create a realization of an AR(4) process. Use `arburg` to determine the reflection coefficients. Use the reflection coefficients to determine an appropriate AR model order for the process. Obtain an estimate of the process PSD.

Create a realization of an AR(4) process 1000 samples in length. Use `arburg` with the order set to 12 to return the reflection coefficients. Plot the reflection coefficients to determine an appropriate model order.

```
A = [1 -2.7607 3.8106 -2.6535 0.9238];  
  
rng default  
  
x = filter(1,A,randn(1000,1));  
  
[a,e,k] = arburg(x,12);  
  
stem(k,'filled')  
title('Reflection Coefficients')  
xlabel('Model Order')
```

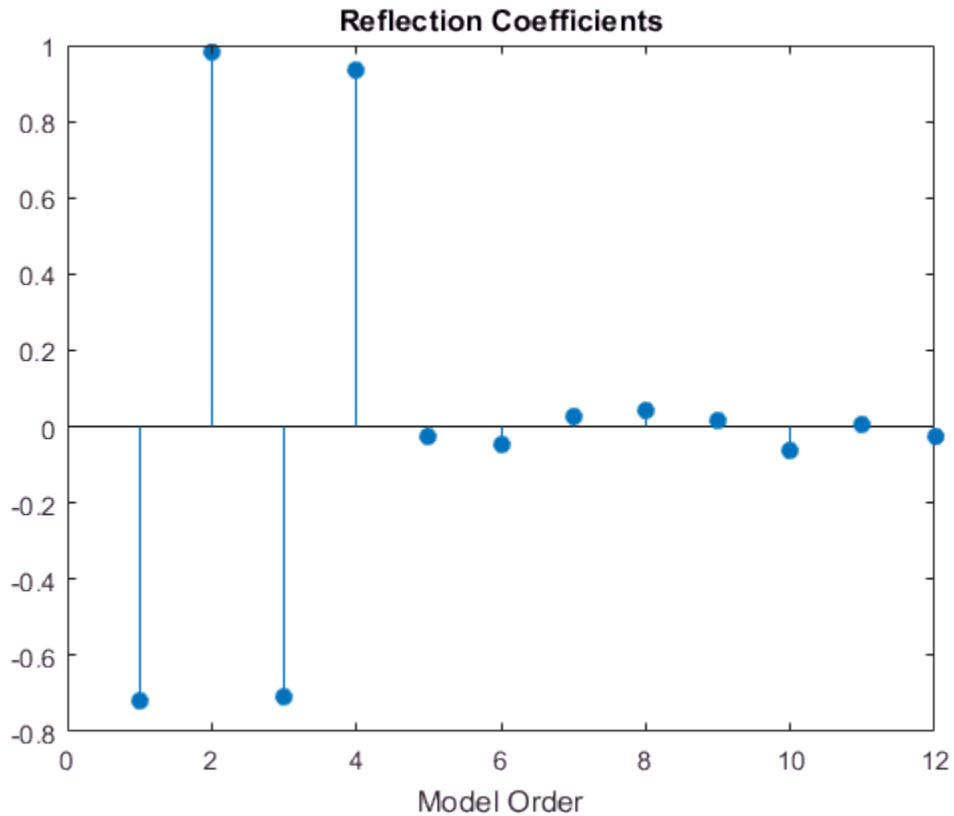

The reflection coefficients decay to zero after order 4. This indicates an AR(4) model is most appropriate.

Obtain a PSD estimate of the random process using Burg's method. Use 1000 points in the DFT. Plot the PSD estimate.

```
pburg(x,4,length(x))
```

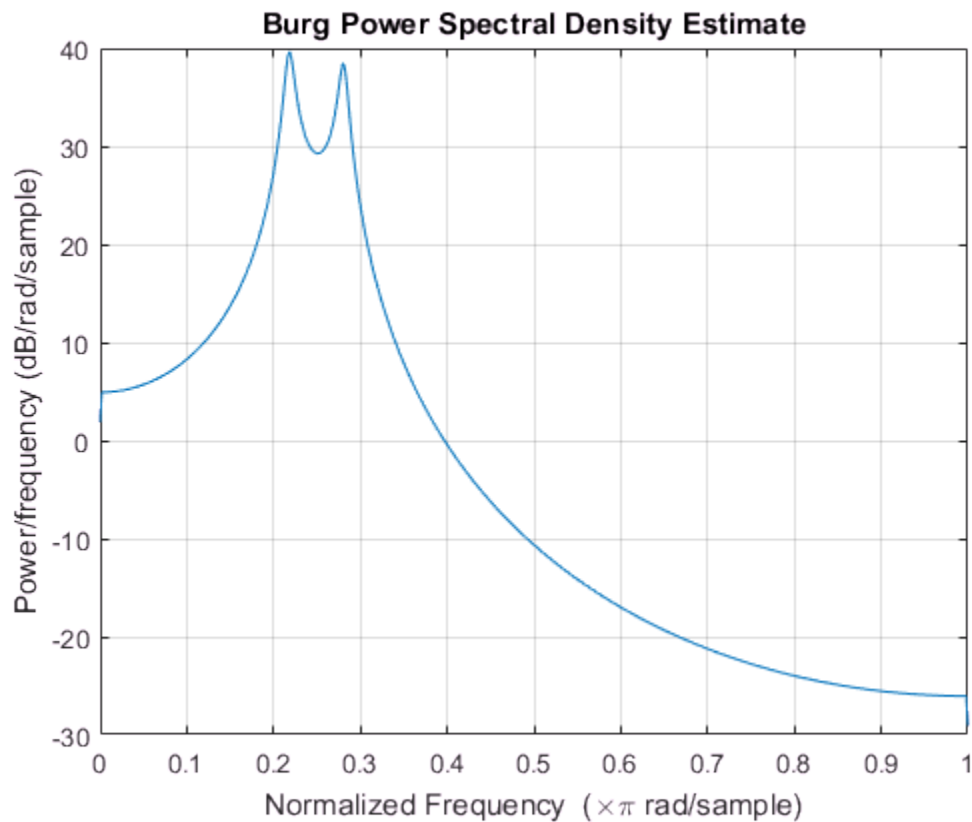

Burg PSD Estimate of a Multichannel Signal

Create a multichannel signal consisting of three sinusoids in additive $N(0, 1)$ white Gaussian noise. The sinusoids' frequencies are 100 Hz, 200 Hz, and 300 Hz. The sampling frequency is 1 kHz, and the signal has a duration of 1 s.

```
Fs = 1000;
```

```
t = 0:1/Fs:1-1/Fs;  
f = [100;200;300];  
x = cos(2*pi*f*t)' + randn(length(t),3);
```

Estimate the PSD of the signal using Burg's method with a 12th-order autoregressive model. Use the default DFT length. Plot the estimate.

```
morder = 12;  
pburg(x,morder,[],Fs)
```

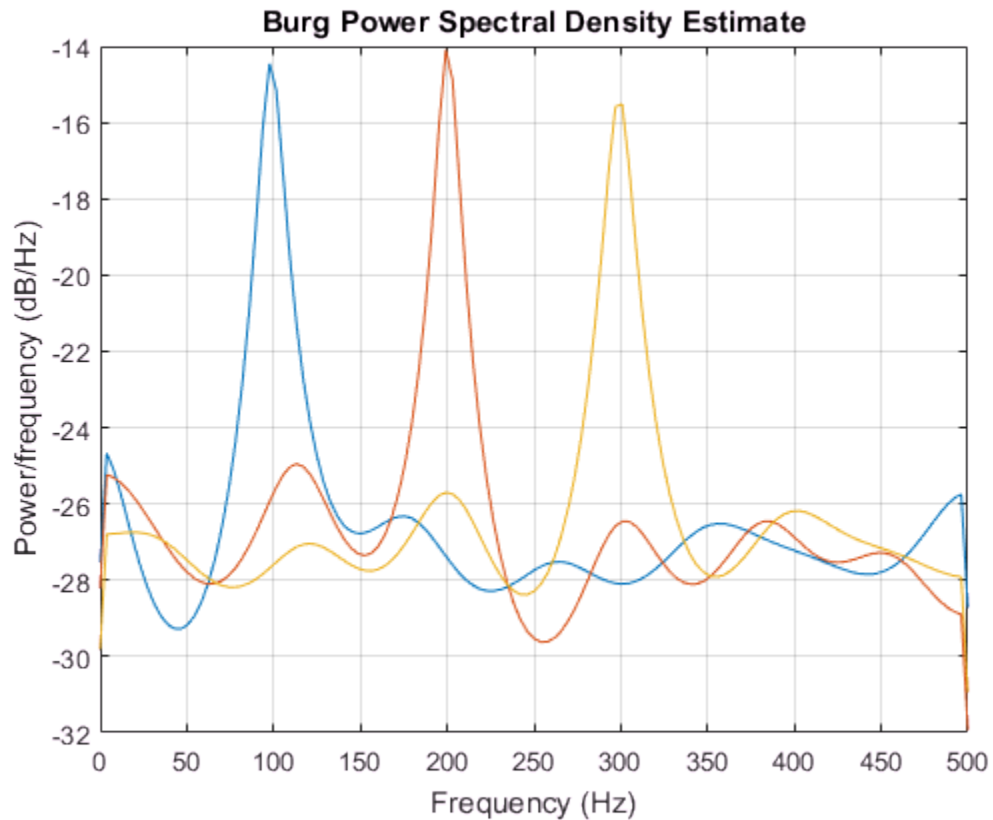

Input Arguments

x — Input signal

vector | matrix

Input signal, specified as a row or column vector, or as a matrix. If **x** is a matrix, then its columns are treated as independent channels.

Example: `cos(pi/4*(0:159))+randn(1,160)` is a single-channel row-vector signal.

Example: `cos(pi./[4;2]*(0:159))'+randn(160,2)` is a two-channel signal.

Data Types: `single` | `double`

Complex Number Support: Yes

order — Order of autoregressive model

positive integer

Order of the autoregressive model, specified as a positive integer.

Data Types: `double`

nfft — Number of DFT points

256 (default) | integer | []

Number of DFT points, specified as a positive integer. For a real-valued input signal, **x**, the PSD estimate, **pxx** has length $(nfft/2+1)$ if **nfft** is even, and $(nfft+1)/2$ if **nfft** is odd. For a complex-valued input signal, **x**, the PSD estimate always has length **nfft**. If **nfft** is specified as empty, the default **nfft** is used.

Data Types: `single` | `double`

fs — Sample rate

positive scalar

Sample rate, specified as a positive scalar. The sample rate is the number of samples per unit time. If the unit of time is seconds, then the sample rate has units of Hz.

w — Normalized frequencies

vector

Normalized frequencies, specified as a row or column vector with at least two elements. Normalized frequencies are in rad/sample.

Example: `w = [pi/4 pi/2]`

Data Types: double

f — Frequencies

vector

Frequencies, specified as a row or column vector with at least two elements. The frequencies are in cycles per unit time. The unit time is specified by the sample rate, `fs`. If `fs` has units of samples/second, then `f` has units of Hz.

Example: `fs = 1000; f = [100 200]`

Data Types: double

freqrange — Frequency range for PSD estimate

'onesided' | 'twosided' | 'centered'

Frequency range for the PSD estimate, specified as a one of 'onesided', 'twosided', or 'centered'. The default is 'onesided' for real-valued signals and 'twosided' for complex-valued signals. The frequency ranges corresponding to each option are

- 'onesided' — returns the one-sided PSD estimate of a real-valued input signal, `x`. If `nfft` is even, `pxx` has length $nfft/2 + 1$ and is computed over the interval $[0, \pi]$ rad/sample. If `nfft` is odd, the length of `pxx` is $(nfft + 1)/2$ and the interval is $[0, \pi)$ rad/sample. When `fs` is optionally specified, the corresponding intervals are $[0, fs/2]$ cycles/unit time and $[0, fs/2)$ cycles/unit time for even and odd length `nfft` respectively.
- 'twosided' — returns the two-sided PSD estimate for either the real-valued or complex-valued input, `x`. In this case, `pxx` has length `nfft` and is computed over the interval $[0, 2\pi)$ rad/sample. When `fs` is optionally specified, the interval is $[0, fs)$ cycles/unit time.
- 'centered' — returns the centered two-sided PSD estimate for either the real-valued or complex-valued input, `x`. In this case, `pxx` has length `nfft` and is computed over the interval $(-\pi, \pi]$ rad/sample for even length `nfft` and $(-\pi, \pi)$ rad/sample for odd length `nfft`. When `fs` is optionally specified, the corresponding intervals are $(-fs/2, fs/2]$ cycles/unit time and $(-fs/2, fs/2)$ cycles/unit time for even and odd length `nfft` respectively.

Data Types: char

probability — Confidence interval for PSD estimate

0.95 (default) | scalar in the range (0,1)

Coverage probability for the true PSD, specified as a scalar in the range (0,1). The output, `pxxc`, contains the lower and upper bounds of the `probability × 100%` interval estimate for the true PSD.

Output Arguments

pxx — PSD estimate

vector | matrix

PSD estimate, returned as a real-valued, nonnegative column vector or matrix. Each column of `pxx` is the PSD estimate of the corresponding column of `x`. The units of the PSD estimate are in squared magnitude units of the time series data per unit frequency. For example, if the input data is in volts, the PSD estimate is in units of squared volts per unit frequency. For a time series in volts, if you assume a resistance of 1Ω and specify the sample rate in hertz, the PSD estimate is in watts per hertz.

Data Types: `single` | `double`

w — Normalized frequencies

vector

Normalized frequencies, returned as a real-valued column vector. If `pxx` is a one-sided PSD estimate, `w` spans the interval $[0, \pi]$ if `nfft` is even and $[0, \pi)$ if `nfft` is odd. If `pxx` is a two-sided PSD estimate, `w` spans the interval $[0, 2\pi)$. For a DC-centered PSD estimate, `w` spans the interval $(-\pi, \pi]$ for even `nfft` and $(-\pi, \pi)$ for odd `nfft`.

Data Types: `double`

f — Cyclical frequencies

vector

Cyclical frequencies, returned as a real-valued column vector. For a one-sided PSD estimate, `f` spans the interval $[0, fs/2]$ when `nfft` is even and $[0, fs/2)$ when `nfft` is odd. For a two-sided PSD estimate, `f` spans the interval $[0, fs)$. For a DC-centered PSD estimate, `f` spans the interval $(-fs/2, fs/2]$ cycles/unit time for even length `nfft` and $(-fs/2, fs/2)$ cycles/unit time for odd length `nfft`.

Data Types: `double`

pxxc — Confidence bounds

matrix

Confidence bounds, returned as a matrix with real-valued elements. The row size of the matrix is equal to the length of the PSD estimate, `pxx`. `pxxc` has twice as many columns as `pxx`. Odd-numbered columns contain the lower bounds of the confidence intervals, and even-numbered columns contain the upper bounds. Thus, `pxxc(m, 2*n - 1)` is the lower confidence bound and `pxxc(m, 2*n)` is the upper confidence bound corresponding to the estimate `pxx(m, n)`. The coverage probability of the confidence intervals is determined by the value of the `probability` input.

Data Types: `single` | `double`

See Also

See Also

`pcov` | `pmcov` | `pyulear`

Introduced before R2006a

pcov

Autoregressive power spectral density estimate — covariance method

Syntax

```

pxx = pcov(x,order)
pxx = pcov(x,order,nfft)

[pxx,w] = pcov( ___ )
[pxx,f] = pcov( ___ ,fs)

[pxx,w] = pcov(x,order,w)
[pxx,f] = pcov(x,order,f,fs)

[ ___ ] = pcov(x,order, ___ ,freqrange)

[ ___ ,pxxc] = pcov( ___ ,'ConfidenceLevel',probability)

pcov( ___ )

```

Description

`pxx = pcov(x,order)` returns the power spectral density (PSD) estimate, `pxx`, of a discrete-time signal, `x`, found using the covariance method. When `x` is a vector, it is treated as a single channel. When `x` is a matrix, the PSD is computed independently for each column and stored in the corresponding column of `pxx`. `pxx` is the distribution of power per unit frequency. The frequency is expressed in units of rad/sample. `order` is the order of the autoregressive (AR) model used to produce the PSD estimate.

`pxx = pcov(x,order,nfft)` uses `nfft` points in the discrete Fourier transform (DFT). For real `x`, `pxx` has length $(nfft/2+1)$ if `nfft` is even, and $(nfft+1)/2$ if `nfft` is odd. For complex-valued `x`, `pxx` always has length `nfft`. If you omit `nfft`, or specify it as empty, then `pcov` uses a default DFT length of 256.

`[pxx,w] = pcov(___)` returns the vector of normalized angular frequencies, `w`, at which the PSD is estimated. `w` has units of radians/sample. For real-valued signals, `w` spans the interval $[0, \pi]$ when `nfft` is even and $[0, \pi)$ when `nfft` is odd. For complex-valued signals, `w` always spans the interval $[0, 2\pi]$.

`[pxx, f] = pcov(____, fs)` returns a frequency vector, `f`, in cycles per unit time. The sampling frequency, `fs`, is the number of samples per unit time. If the unit of time is seconds, then `f` is in cycles/second (Hz). For real-valued signals, `f` spans the interval `[0, fs/2]` when `nfft` is even and `[0, fs/2)` when `nfft` is odd. For complex-valued signals, `f` spans the interval `[0, fs)`.

`[pxx, w] = pcov(x, order, w)` returns the two-sided AR PSD estimates at the normalized frequencies specified in the vector, `w`. The vector, `w`, must contain at least two elements.

`[pxx, f] = pcov(x, order, f, fs)` returns the two-sided AR PSD estimates at the frequencies specified in the vector, `f`. The vector, `f`, must contain at least two elements. The frequencies in `f` are in cycles per unit time. The sampling frequency, `fs`, is the number of samples per unit time. If the unit of time is seconds, then `f` is in cycles/second (Hz).

`[____] = pcov(x, order, ____, freqrange)` returns the AR PSD estimate over the frequency range specified by `freqrange`. Valid options for `freqrange` are: `'onesided'`, `'twosided'`, or `'centered'`.

`[____, pxxc] = pcov(____, 'ConfidenceLevel', probability)` returns the `probability` × 100% confidence intervals for the PSD estimate in `pxxc`.

`pcov(____)` with no output arguments plots the AR PSD estimate in dB per unit frequency in the current figure window.

Examples

Covariance-Method PSD Estimate of an AR(4) Process

Create a realization of an AR(4) wide-sense stationary random process. Estimate the PSD using the covariance method. Compare the PSD estimate based on a single realization to the true PSD of the random process.

Create an AR(4) system function. Obtain the frequency response and plot the PSD of the system.

```
A = [1 -2.7607 3.8106 -2.6535 0.9238];
[H, F] = freqz(1, A, [], 1);
plot(F, 20*log10(abs(H)))
```

```
xlabel('Frequency (Hz)')  
ylabel('PSD (dB/Hz)')
```

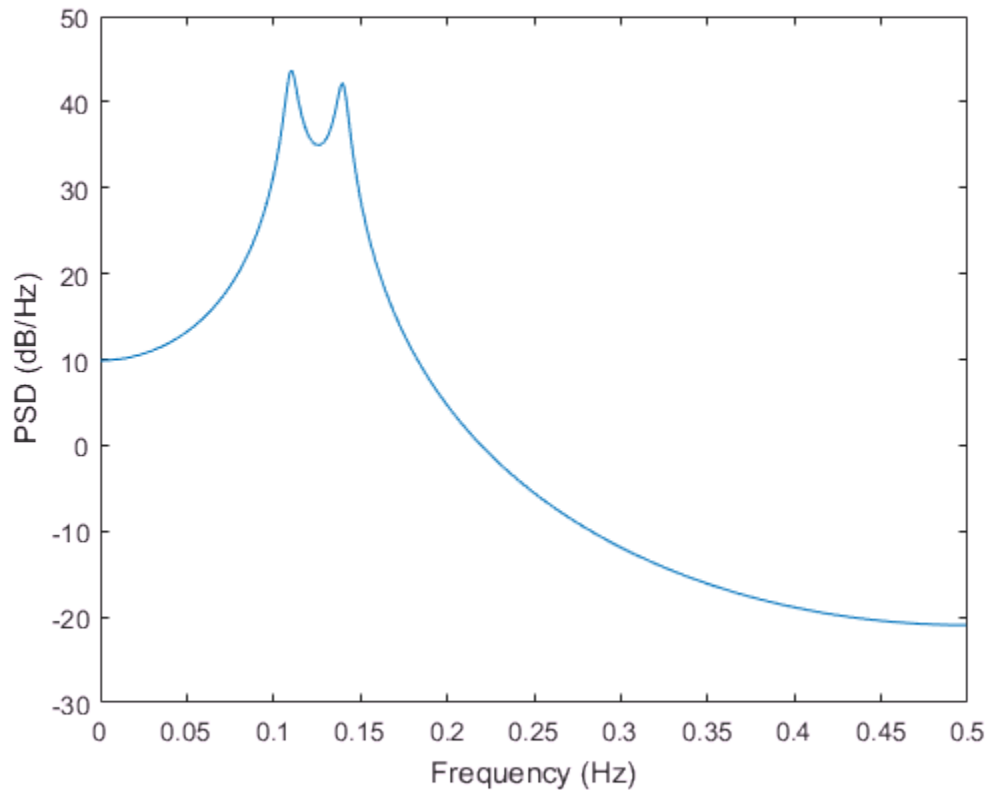

Create a realization of the AR(4) random process. Set the random number generator to the default settings for reproducible results. The realization is 1000 samples in length. Assume a sampling frequency of 1 Hz. Use `pcov` to estimate the PSD for a 4th-order process. Compare the PSD estimate with the true PSD.

```
rng default
```

```
x = randn(1000,1);  
y = filter(1,A,x);  
[Pxx,F] = pcov(y,4,1024,1);
```

```
hold on
plot(F, 10*log10(Pxx))
legend('True Power Spectral Density', 'pcov PSD Estimate')
```

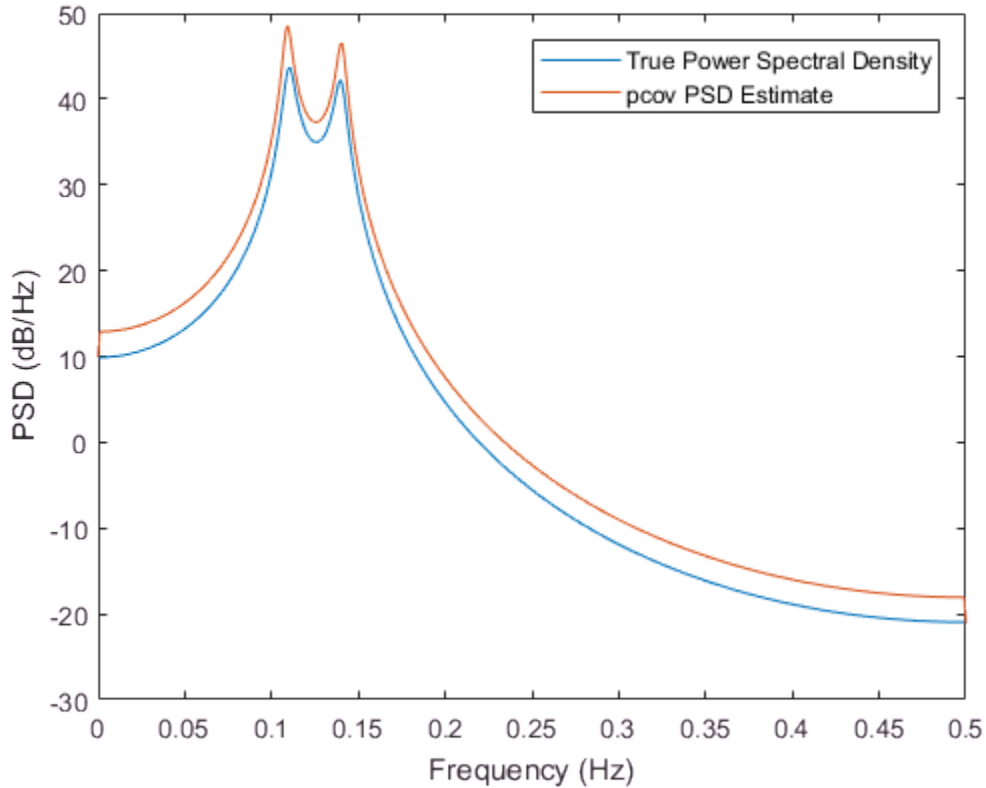

Covariance-Method PSD Estimate of a Multichannel Signal

Create a multichannel signal consisting of three sinusoids in additive $N(0, 1)$ white Gaussian noise. The sinusoids' frequencies are 100 Hz, 200 Hz, and 300 Hz. The sampling frequency is 1 kHz, and the signal has a duration of 1 s.

`Fs = 1000;`

```
t = 0:1/Fs:1-1/Fs;  
f = [100;200;300];  
x = cos(2*pi*f*t)' + randn(length(t),3);
```

Estimate the PSD of the signal using the covariance method with a 12th-order autoregressive model. Use the default DFT length. Plot the estimate.

```
morder = 12;  
pcov(x,morder,[],Fs)
```

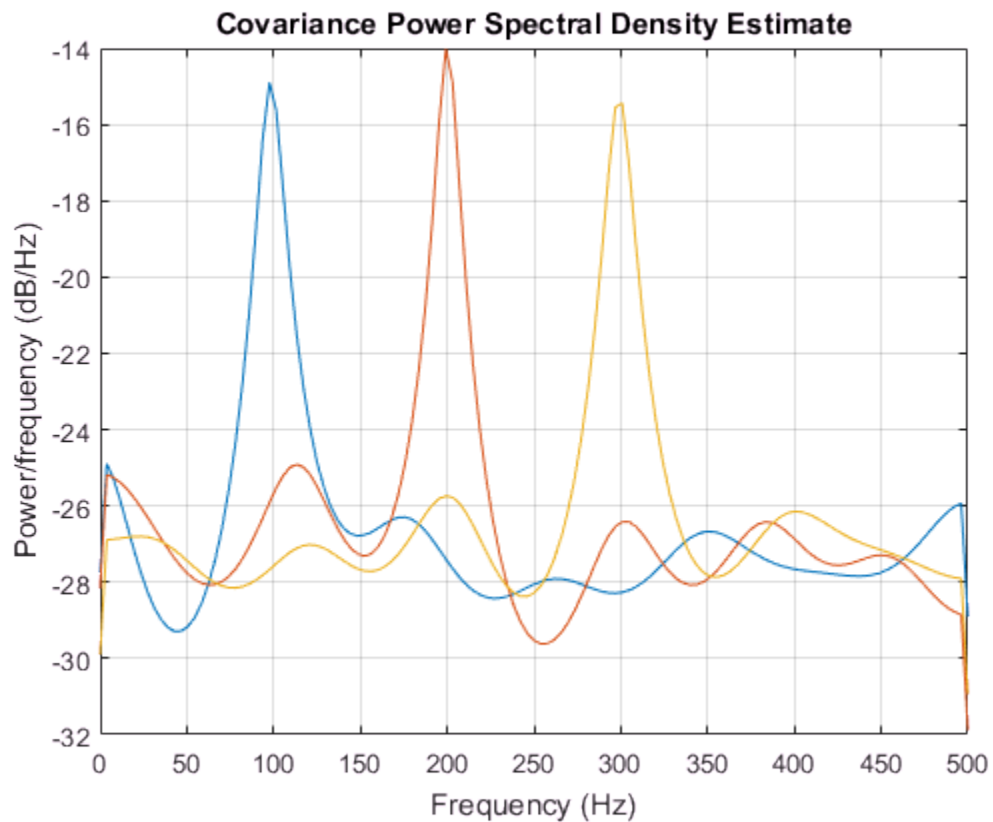

Input Arguments

x — Input signal

vector | matrix

Input signal, specified as a row or column vector, or as a matrix. If **x** is a matrix, then its columns are treated as independent channels.

Example: `cos(pi/4*(0:159))+randn(1,160)` is a single-channel row-vector signal.

Example: `cos(pi./[4;2]*(0:159))'+randn(160,2)` is a two-channel signal.

Data Types: `single` | `double`

Complex Number Support: Yes

order — Order of autoregressive model

positive integer

Order of the autoregressive model, specified as a positive integer.

Data Types: `double`

nfft — Number of DFT points

256 (default) | integer | []

Number of DFT points, specified as a positive integer. For a real-valued input signal, **x**, the PSD estimate, **pxx** has length $(nfft/2+1)$ if **nfft** is even, and $(nfft+1)/2$ if **nfft** is odd. For a complex-valued input signal, **x**, the PSD estimate always has length **nfft**. If **nfft** is specified as empty, the default **nfft** is used.

Data Types: `single` | `double`

fs — Sample rate

positive scalar

Sample rate, specified as a positive scalar. The sample rate is the number of samples per unit time. If the unit of time is seconds, then the sample rate has units of Hz.

w — Normalized frequencies

vector

Normalized frequencies, specified as a row or column vector with at least two elements. Normalized frequencies are in rad/sample.

Example: `w = [pi/4 pi/2]`

Data Types: double

f — Frequencies

vector

Frequencies, specified as a row or column vector with at least two elements. The frequencies are in cycles per unit time. The unit time is specified by the sample rate, `fs`. If `fs` has units of samples/second, then `f` has units of Hz.

Example: `fs = 1000; f = [100 200]`

Data Types: double

freqrange — Frequency range for PSD estimate

'onesided' | 'twosided' | 'centered'

Frequency range for the PSD estimate, specified as a one of 'onesided', 'twosided', or 'centered'. The default is 'onesided' for real-valued signals and 'twosided' for complex-valued signals. The frequency ranges corresponding to each option are

- 'onesided' — returns the one-sided PSD estimate of a real-valued input signal, `x`. If `nfft` is even, `pxx` has length $nfft/2 + 1$ and is computed over the interval $[0, \pi]$ rad/sample. If `nfft` is odd, the length of `pxx` is $(nfft + 1)/2$ and the interval is $[0, \pi)$ rad/sample. When `fs` is optionally specified, the corresponding intervals are $[0, fs/2]$ cycles/unit time and $[0, fs/2)$ cycles/unit time for even and odd length `nfft` respectively.
- 'twosided' — returns the two-sided PSD estimate for either the real-valued or complex-valued input, `x`. In this case, `pxx` has length `nfft` and is computed over the interval $[0, 2\pi)$ rad/sample. When `fs` is optionally specified, the interval is $[0, fs)$ cycles/unit time.
- 'centered' — returns the centered two-sided PSD estimate for either the real-valued or complex-valued input, `x`. In this case, `pxx` has length `nfft` and is computed over the interval $(-\pi, \pi]$ rad/sample for even length `nfft` and $(-\pi, \pi)$ rad/sample for odd length `nfft`. When `fs` is optionally specified, the corresponding intervals are $(-fs/2, fs/2]$ cycles/unit time and $(-fs/2, fs/2)$ cycles/unit time for even and odd length `nfft` respectively.

Data Types: char

probability — Confidence interval for PSD estimate

0.95 (default) | scalar in the range (0,1)

Coverage probability for the true PSD, specified as a scalar in the range (0,1). The output, `pxxc`, contains the lower and upper bounds of the `probability × 100%` interval estimate for the true PSD.

Output Arguments

`pxx` — PSD estimate

vector | matrix

PSD estimate, returned as a real-valued, nonnegative column vector or matrix. Each column of `pxx` is the PSD estimate of the corresponding column of `x`. The units of the PSD estimate are in squared magnitude units of the time series data per unit frequency. For example, if the input data is in volts, the PSD estimate is in units of squared volts per unit frequency. For a time series in volts, if you assume a resistance of 1 Ω and specify the sample rate in hertz, the PSD estimate is in watts per hertz.

Data Types: `single` | `double`

`w` — Normalized frequencies

vector

Normalized frequencies, returned as a real-valued column vector. If `pxx` is a one-sided PSD estimate, `w` spans the interval $[0, \pi]$ if `nfft` is even and $[0, \pi)$ if `nfft` is odd. If `pxx` is a two-sided PSD estimate, `w` spans the interval $[0, 2\pi)$. For a DC-centered PSD estimate, `w` spans the interval $(-\pi, \pi]$ for even `nfft` and $(-\pi, \pi)$ for odd `nfft`.

Data Types: `double`

`f` — Cyclical frequencies

vector

Cyclical frequencies, returned as a real-valued column vector. For a one-sided PSD estimate, `f` spans the interval $[0, fs/2]$ when `nfft` is even and $[0, fs/2)$ when `nfft` is odd. For a two-sided PSD estimate, `f` spans the interval $[0, fs)$. For a DC-centered PSD estimate, `f` spans the interval $(-fs/2, fs/2]$ cycles/unit time for even length `nfft` and $(-fs/2, fs/2)$ cycles/unit time for odd length `nfft`.

Data Types: `double`

`pxxc` — Confidence bounds

matrix

Confidence bounds, returned as a matrix with real-valued elements. The row size of the matrix is equal to the length of the PSD estimate, `pxx`. `pxxc` has twice as many columns as `pxx`. Odd-numbered columns contain the lower bounds of the confidence intervals, and even-numbered columns contain the upper bounds. Thus, `pxxc(m, 2*n - 1)` is the lower confidence bound and `pxxc(m, 2*n)` is the upper confidence bound corresponding to the estimate `pxx(m, n)`. The coverage probability of the confidence intervals is determined by the value of the `probability` input.

Data Types: `single` | `double`

See Also

See Also

`pburg` | `pmcov` | `pyulear`

Introduced before R2006a

peak2peak

Maximum-to-minimum difference

Syntax

```
Y = peak2peak(X)  
Y = peak2peak(X,DIM)
```

Description

`Y = peak2peak(X)` returns the difference between the maximum and minimum values in `X`. `peak2peak` operates along the first nonsingleton dimension of `X` by default. For example, if `X` is a row or column vector, `Y` is a real-valued scalar. If `Y` is an N -by- M matrix with $N > 1$, `Y` is a 1-by- M row vector containing the maximum-to-minimum differences of the columns of `X`.

`Y = peak2peak(X,DIM)` computes the maximum-to-minimum differences of `X` along the dimension, `DIM`.

Input Arguments

X

Real- or complex-valued input vector or matrix. By default, `peak2peak` acts along the first nonsingleton dimension of `X`. For complex-valued inputs, `peak2peak` identifies the maximum and minimum in absolute value. `peak2peak` subtracts the complex number with the minimum modulus from the complex number with the maximum modulus.

DIM

Dimension for maximum-to-minimum difference. The optional `DIM` input argument specifies the dimension along which to compute the maximum-to-minimum differences.

Default: First nonsingleton dimension

Output Arguments

Y

Maximum-to-minimum difference. For vectors, Y is a real-valued scalar. For matrices, Y contains the maximum-to-minimum differences computed along the specified dimension, DIM. By default, DIM is the first nonsingleton dimension.

Examples

Peak-to-Peak Difference of Sinusoid

Compute the maximum-to-minimum difference of a 100 Hz sinusoid sampled at 1 kHz.

```
t = 0:0.001:1-0.001;  
x = cos(2*pi*100*t);
```

```
y = peak2peak(x)
```

```
y = 2
```

Peak-to-Peak Difference of Complex Exponential

Compute the maximum-to-minimum difference of a complex exponential with a frequency of $\pi/4$ rad/sample.

Create a complex exponential with a frequency of $\pi/4$ rad/sample. Find the peak-to-peak difference.

```
n = 0:99;  
x = exp(1j*pi/4*n);
```

```
y = peak2peak(x)
```

```
y =  
-1.7071 - 0.7071i
```

Peak-to-Peak Differences of 2-D Matrix

Create a matrix where each column is a 100 Hz sinusoid sampled at 1 kHz with a different amplitude. The amplitude is equal to the column index.

Compute the maximum-to-minimum differences of the columns.

```
t = 0:0.001:1-0.001;  
x = cos(2*pi*100*t)'*(1:4);  
  
y = peak2peak(x)  
  
y =  
  
     2     4     6     8
```

Peak-to-Peak Differences of 2-D Matrix Along Specified Dimension

Create a matrix where each row is a 100 Hz sinusoid sampled at 1 kHz with a different amplitude. The amplitude is equal to the row index.

Compute the maximum-to-minimum differences of the rows specifying the dimension equal to 2 with the DIM argument.

```
t = 0:0.001:1-0.001;  
x = (1:4)'*cos(2*pi*100*t);  
  
y = peak2peak(x,2)  
  
y =  
  
     2  
     4  
     6  
     8
```

References

- [1] *IEEE Standard on Transitions, Pulses, and Related Waveforms*, IEEE Standard 181, 2003.

Extended Capabilities

C/C++ Code Generation

Generate C and C++ code using MATLAB® Coder™.

See Also

See Also

`max` | `min` | `peak2rms` | `rms` | `rssq`

Introduced in R2012a

peak2rms

Peak-magnitude-to-RMS ratio

Syntax

$Y = \text{peak2rms}(X)$
 $Y = \text{peak2rms}(X, \text{DIM})$

Description

$Y = \text{peak2rms}(X)$ returns the ratio of the largest absolute value in X to the root-mean-square (RMS) value of X . `peak2rms` operates along the first nonsingleton dimension of X . For example, if X is a row or column vector, Y is a real-valued scalar. If Y is an N -by- M matrix with $N > 1$, Y is a 1-by- M row vector containing the peak-magnitude-to-RMS levels of the columns of Y .

$Y = \text{peak2rms}(X, \text{DIM})$ computes the peak-magnitude-to-RMS level of X along the dimension, DIM .

Input Arguments

X

Real- or complex-valued input vector or matrix. By default, `peak2rms` acts along the first nonsingleton dimension of X .

DIM

Dimension for peak-magnitude-to-RMS ratio. The optional DIM input argument specifies the dimension along which to compute the peak-magnitude-to-RMS level.

Default: First nonsingleton dimension

Output Arguments

Y

Peak-magnitude-to-RMS ratio. For vectors, Y is a real-valued scalar. For matrices, Y contains the peak-magnitude-to-RMS levels computed along the specified dimension, DIM. By default, DIM is the first nonsingleton dimension.

Examples

Peak-Magnitude-to-RMS Ratio of Sinusoid

Compute the peak-magnitude-to-RMS ratio of a 100 Hz sinusoid sampled at 1 kHz.

```
t = 0:0.001:1-0.001;  
x = cos(2*pi*100*t);
```

```
y = peak2rms(x)
```

```
y = 1.4142
```

Peak-Magnitude-to-RMS Ratio of Complex Exponential

Compute the peak-magnitude-to-RMS ratio of a complex exponential with a frequency of $\pi/4$ rad/sample.

Create a complex exponential with a frequency of $\pi/4$ rad/sample. Find the peak-magnitude-to-RMS ratio.

```
n = 0:99;  
x = exp(1j*pi/4*n);
```

```
y = peak2rms(x)
```

```
y = 1
```

Peak-Magnitude-to-RMS Ratios of 2-D Matrix

Create a matrix where each column is a 100 Hz sinusoid sampled at 1 kHz with a different amplitude. The amplitude is equal to the column index.

Compute the peak-magnitude-to-RMS ratios of the columns.

```
t = 0:0.001:1-0.001;  
x = cos(2*pi*100*t)'*(1:4);  
  
y = peak2rms(x)  
  
y =  
  
    1.4142    1.4142    1.4142    1.4142
```

Peak-Magnitude-to-RMS Ratios of 2-D Matrix Along Specified Dimension

Create a matrix where each row is a 100 Hz sinusoid sampled at 1 kHz with a different amplitude. The amplitude is equal to the row index.

Compute the RMS levels of the rows specifying the dimension equal to 2 with the **DIM** argument.

```
t = 0:0.001:1-0.001;  
x = (1:4)'*cos(2*pi*100*t);  
  
y = peak2rms(x,2)  
  
y =  
  
    1.4142  
    1.4142  
    1.4142  
    1.4142
```

Definitions

Peak-magnitude-to-RMS Level

The peak-magnitude-to-RMS ratio is

$$\frac{\|X\|_{\infty}}{\sqrt{\frac{1}{N} \sum_{n=1}^N |X_n|^2}},$$

where the ℓ -infinity norm and RMS values are computed along the specified dimension.

References

- [1] *IEEE Standard on Transitions, Pulses, and Related Waveforms*, IEEE Standard 181, 2003.

Extended Capabilities

C/C++ Code Generation

Generate C and C++ code using MATLAB® Coder™.

See Also

See Also

[max](#) | [mean](#) | [min](#) | [peak2peak](#) | [rms](#) | [rssq](#)

Introduced in R2012a

peig

Pseudospectrum using eigenvector method

Syntax

```
[S,w] = peig(x,p)
[S,w] = peig(x,p,w)
[S,w] = peig(...,nfft)
[S,f] = peig(x,p,nfft,fs)
[S,f] = peig(x,p,f,fs)
[S,f] = peig(...,'corr')
[S,f] = peig(x,p,nfft,fs,nwin,noverlap)
[...] = peig(...,freqrange)
[... ,v,e] = peig(...)
peig(...)
```

Description

`[S,w] = peig(x,p)` implements the eigenvector spectral estimation method and returns `S`, the pseudospectrum estimate of the input signal `x`, and `w`, a vector of normalized frequencies (in rad/sample) at which the pseudospectrum is evaluated. The pseudospectrum is calculated using estimates of the eigenvectors of a correlation matrix associated with the input data `x`, where `x` is specified as either:

- A row or column vector representing one observation of the signal
- A rectangular array for which each row of `x` represents a separate observation of the signal (for example, each row is one output of an array of sensors, as in array processing), such that $x' * x$ is an estimate of the correlation matrix

Note You can use the output of `corrmtx` to generate such an array `x`.

You can specify the second input argument `p` as either:

- A scalar integer. In this case, the signal subspace dimension is `p`.
- A two-element vector. In this case, `p(2)`, the second element of `p`, represents a threshold that is multiplied by λ_{\min} , the smallest estimated eigenvalue of the signal's

correlation matrix. Eigenvalues below the threshold $\lambda_{\min} \times p(2)$ are assigned to the noise subspace. In this case, $p(1)$ specifies the maximum dimension of the signal subspace.

Note: If the inputs to `peig` are real sinusoids, set the value of p to double the number of input signals. If the inputs are complex sinusoids, set p equal to the number of inputs.

The extra threshold parameter in the second entry in p provides you more flexibility and control in assigning the noise and signal subspaces.

S and w have the same length. In general, the length of the FFT and the values of the input x determine the length of the computed S and the range of the corresponding normalized frequencies. The following table indicates the length of S (and w) and the range of the corresponding normalized frequencies for this syntax.

S Characteristics for an FFT Length of 256 (Default)

Real/Complex Input Data	Length of S and w	Range of the Corresponding Normalized Frequencies
Real-valued	129	$[0, \pi]$
Complex-valued	256	$[0, 2\pi)$

$[S, w] = \text{peig}(x, p, w)$ returns the pseudospectrum in the vector S computed at the normalized frequencies specified in vector w , which has two or more elements

$[S, w] = \text{peig}(\dots, nfft)$ specifies the integer length of the FFT $nfft$ used to estimate the pseudospectrum. The default value for $nfft$ (entered as an empty vector $[\]$) is 256.

The following table indicates the length of S and w , and the frequency range for w for this syntax.

S and Frequency Vector Characteristics

Real/Complex Input Data	$nfft$ Even/Odd	Length of S and w	Range of w
Real-valued	Even	$(nfft/2 + 1)$	$[0, \pi]$
Real-valued	Odd	$(nfft + 1)/2$	$[0, \pi)$
Complex-valued	Even or odd	$nfft$	$[0, 2\pi)$

$[S, f] = \text{peig}(x, p, nfft, fs)$ returns the pseudospectrum in the vector S evaluated at the corresponding vector of frequencies f (in Hz). You supply the sampling frequency fs in Hz. If you specify fs with the empty vector $[]$, the sampling frequency defaults to 1 Hz.

The frequency range for f depends on $nfft$, fs , and the values of the input x . The length of S (and f) is the same as in the S and Frequency Vector Characteristics above. The following table indicates the frequency range for f for this syntax.

S and Frequency Vector Characteristics with fs Specified

Real/Complex Input Data	nfft Even/Odd	Range of f
Real-valued	Even	$[0, fs/2]$
Real-valued	Odd	$[0, fs/2)$
Complex-valued	Even or odd	$[0, fs)$

$[S, f] = \text{peig}(x, p, f, fs)$ returns the pseudospectrum in the vector S computed at the frequencies specified in vector f , which has two or more elements

$[S, f] = \text{peig}(\dots, 'corr')$ forces the input argument x to be interpreted as a correlation matrix rather than matrix of signal data. For this syntax x must be a square matrix, and all of its eigenvalues must be nonnegative.

$[S, f] = \text{peig}(x, p, nfft, fs, nwin, noverlap)$ allows you to specify $nwin$, a scalar integer indicating a rectangular window length, or a real-valued vector specifying window coefficients. Use the scalar integer $noverlap$ in conjunction with $nwin$ to specify the number of input sample points by which successive windows overlap. $noverlap$ is not used if x is a matrix. The default value for $nwin$ is $2 \times p(1)$ and $noverlap$ is $nwin - 1$.

With this syntax, the input data x is segmented and windowed before the matrix used to estimate the correlation matrix eigenvalues is formulated. The segmentation of the data depends on $nwin$, $noverlap$, and the form of x . Comments on the resulting windowed segments are described in the following table.

Windowed Data Depending on x and nwin

Input data x	Form of nwin	Windowed Data
Data vector	Scalar	Length is $nwin$

Input data x	Form of $nwin$	Windowed Data
Data vector	Vector of coefficients	Length is <code>length(nwin)</code>
Data matrix	Scalar	Data is not windowed.
Data matrix	Vector of coefficients	<code>length(nwin)</code> must be the same as the column length of x , and <code>noverlap</code> is not used.

See the table, Eigenvector Length Depending on Input Data and Syntax, for related information on this syntax.

Note The arguments `nwin` and `noverlap` are ignored when you include 'corr' in the syntax.

`[...] = peig(..., freqrange)` specifies the range of frequency values to include in f or w . `freqrange` can be either:

- 'half' — returns half the spectrum for a real input signal, x . If `nfft` is even, then S has length `nfft/2 + 1` and is computed over the interval $[0, \pi]$. If `nfft` is odd, the length of S is `(nfft + 1)/2` and the frequency interval is $[0, \pi]$. When you specify `fs`, the intervals are $[0, fs/2)$ and $[0, fs/2]$ for even and odd `nfft`, respectively.
- 'whole' — returns the whole spectrum for either real or complex input, x . In this case, S has length `nfft` and is computed over the interval $[0, 2\pi]$. When you specify `fs`, the frequency interval is $[0, fs)$.
- 'centered' — returns the centered whole spectrum for either real or complex input, x . In this case, S has length `nfft` and is computed over the interval $(-\pi, \pi]$ for even `nfft` and $(-\pi, \pi)$ for odd `nfft`. When you specify `fs`, the frequency intervals are $(-fs/2, fs/2]$ and $(-fs/2, fs/2)$ for even and odd `nfft`, respectively.

Note You can put the arguments `freqrange` or 'corr' anywhere in the input argument list after `p`.

`[..., v, e] = peig(...)` returns the matrix v of noise eigenvectors, along with the associated eigenvalues in the vector e . The columns of v span the noise subspace of dimension `size(v, 2)`. The dimension of the signal subspace is `size(v, 1) - size(v, 2)`. For this syntax, e is a vector of estimated eigenvalues of the correlation matrix.

`peig(...)` with no output arguments plots the pseudospectrum in the current figure window.

Examples

Pseudospectrum of Sum of Sinusoids

Implement the eigenvector method to find the pseudospectrum of the sum of three sinusoids in noise. Use the default FFT length of 256. The inputs are complex sinusoids so you set `p` equal to the number of inputs. Use the modified covariance method for the correlation matrix estimate.

```
n = 0:99;
s = exp(1i*pi/2*n)+2*exp(1i*pi/4*n)+exp(1i*pi/3*n)+randn(1,100);
X = corrmtx(s,12,'mod');
peig(X,3,'whole')
```

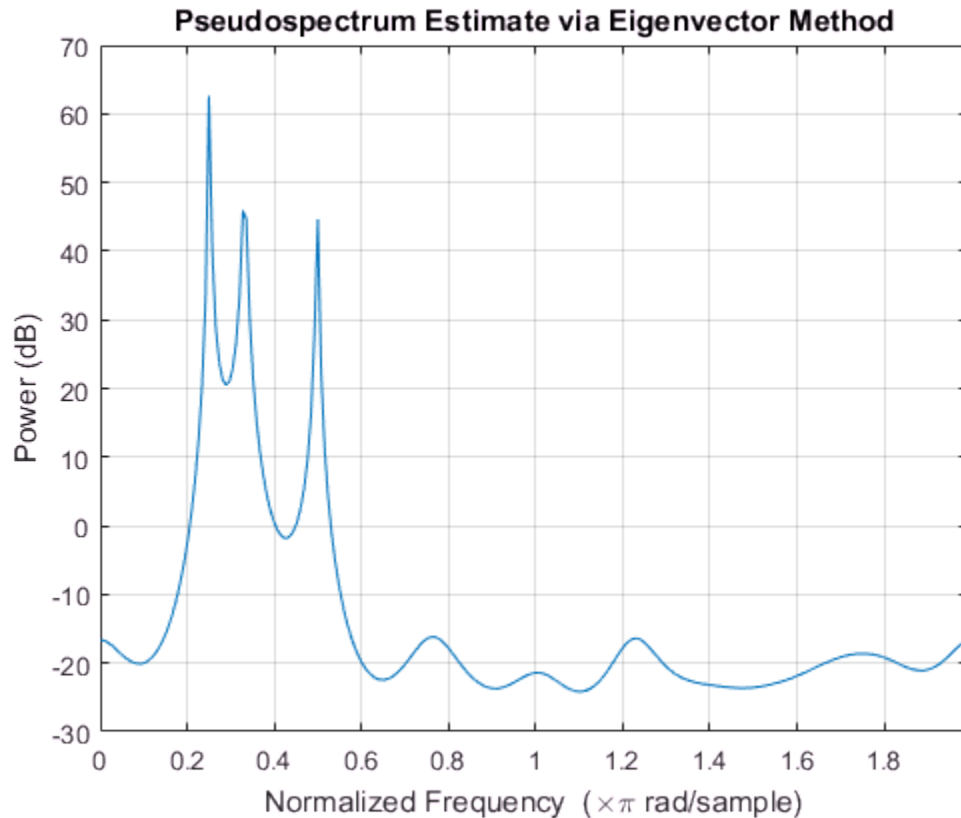
Pseudospectrum of Real Signal

Generate a real signal that consists of the sum of two sinusoids embedded in white Gaussian noise of unit variance. The signal is sampled at 100 Hz for 1 second. The sinusoids have frequencies of 25 Hz and 35 Hz. The lower-frequency sinusoid has twice the amplitude of the other.

```
fs = 100;
t = 0:1/fs:1-1/fs;

s = 2*sin(2*pi*25*t)+sin(2*pi*35*t)+randn(1,100);
```

Use the eigenvector method to compute the pseudospectrum of the signal between 0 and the Nyquist frequency. Specify a signal subspace dimension of 2 and a DFT length of 512.

```
peig(s,2,512,fs,'half')
```

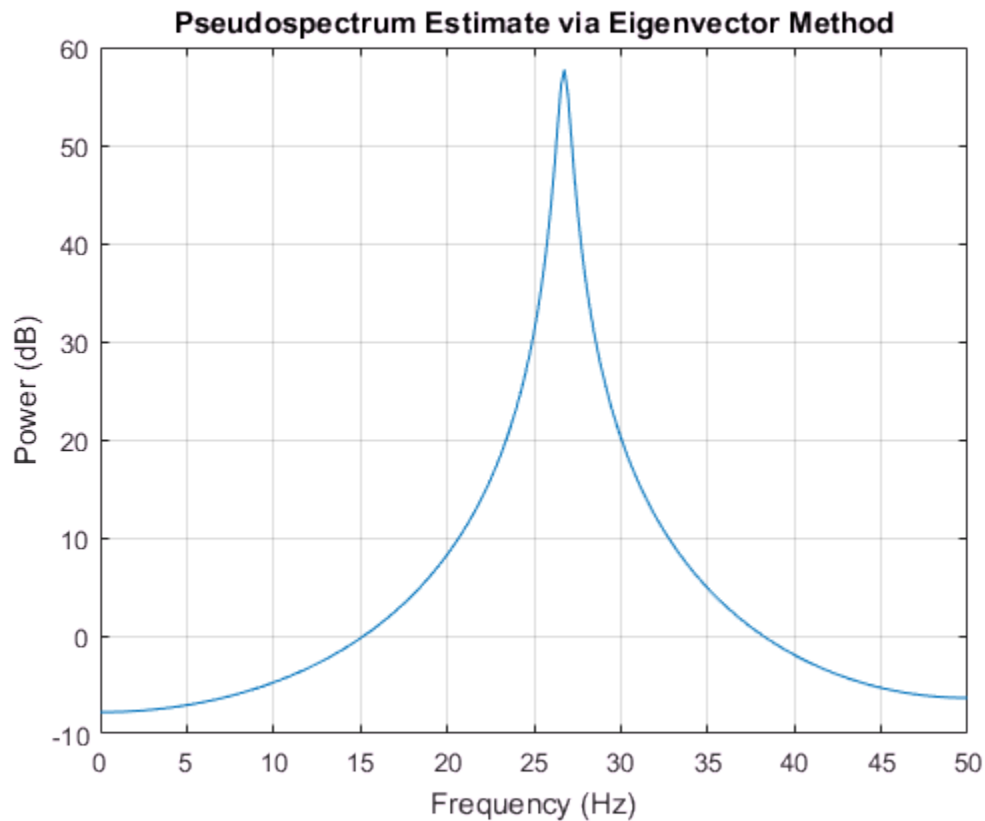

It is not possible to resolve the two sinusoids because the signal is real. Repeat the computation using a signal subspace of dimension 4.

```
peig(s,4,512,fs,'half')
```

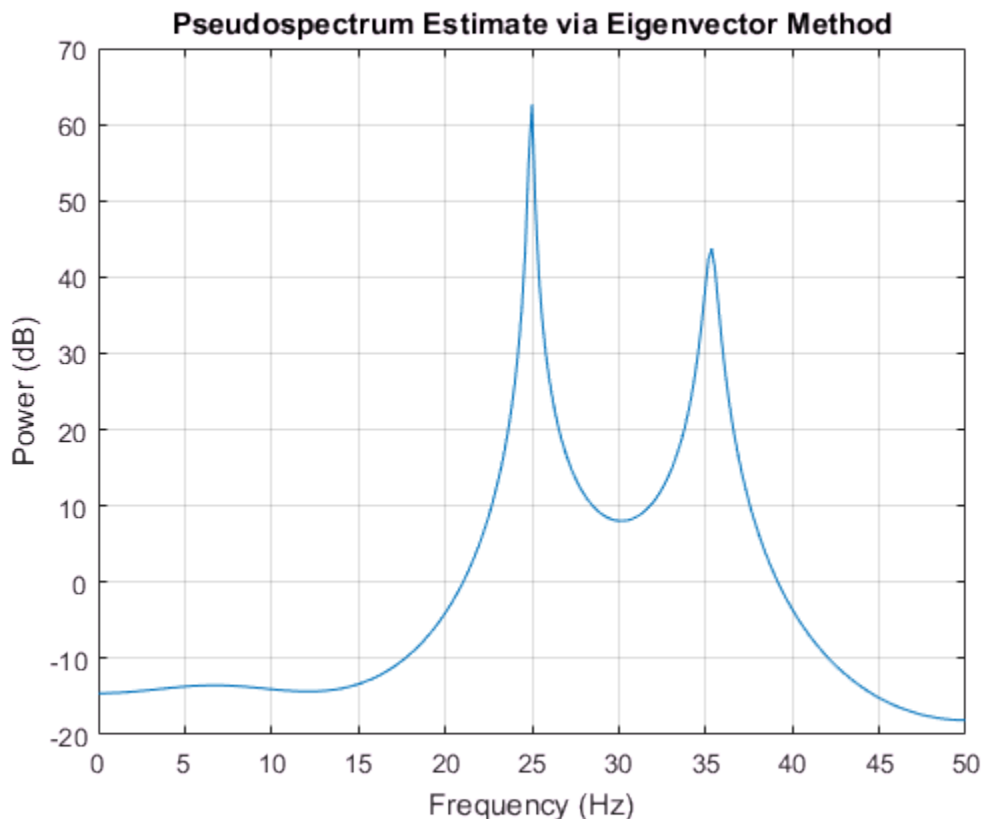

Tips

In the process of estimating the pseudospectrum, `peig` computes the noise and signal subspaces from the estimated eigenvectors v_j and eigenvalues λ_j of the signal's correlation matrix. The smallest of these eigenvalues is used in conjunction with the threshold parameter `p(2)` to affect the dimension of the noise subspace in some cases.

The length n of the eigenvectors computed by `peig` is the sum of the dimensions of the signal and noise subspaces. This eigenvector length depends on your input (signal data or correlation matrix) and the syntax you use.

The following table summarizes the dependency of the eigenvector length on the input argument.

Eigenvector Length Depending on Input Data and Syntax

Form of Input Data x	Comments on the Syntax	Length n of Eigenvectors
Row or column vector	<code>nwin</code> is specified as a scalar integer.	<code>nwin</code>
Row or column vector	<code>nwin</code> is specified as a vector.	<code>length(nwin)</code>
Row or column vector	<code>nwin</code> is not specified.	$2 \times p(1)$
l -by- m matrix	If <code>nwin</code> is specified as a scalar, it is not used. If <code>nwin</code> is specified as a vector, <code>length(nwin)</code> must equal m .	m
m -by- m nonnegative definite matrix	' <code>corr</code> ' is specified and <code>nwin</code> is not used.	m

You should specify `nwin > p(1)` or `length(nwin) > p(1)` if you want `p(2) > 1` to have any effect.

Algorithms

The eigenvector method estimates the pseudospectrum from a signal or a correlation matrix using a weighted version of the MUSIC algorithm derived from Schmidt's eigenspace analysis method [1] [2]. The algorithm performs eigenspace analysis of the signal's correlation matrix in order to estimate the signal's frequency content. The eigenvalues and eigenvectors of the signal's correlation matrix are estimated using `svd` if you don't supply the correlation matrix. This algorithm is particularly suitable for signals that are the sum of sinusoids with additive white Gaussian noise.

The eigenvector method produces a pseudospectrum estimate given by

$$P_{ev}(f) = \frac{1}{\sum_{k=p+1}^N |v_k^H e(f)|^2 / \lambda_k}$$

where N is the dimension of the eigenvectors and v_k is the k th eigenvector of the correlation matrix of the input signal. The integer p is the dimension of the signal subspace, so the eigenvectors v_k used in the sum correspond to the smallest eigenvalues λ_k of the correlation matrix. The eigenvectors used span the noise subspace. The vector $e(f)$ consists of complex exponentials, so the inner product

$$v_k^H e(f)$$

amounts to a Fourier transform. This is used for computation of the pseudospectrum. The FFT is computed for each v_k and then the squared magnitudes are summed and scaled.

References

- [1] Marple, S. Lawrence. *Digital Spectral Analysis*. Englewood Cliffs, NJ: Prentice-Hall, 1987, pp.373–378.
- [2] Schmidt, R. O. “Multiple Emitter Location and Signal Parameter Estimation.” *IEEE Transactions on Antennas and Propagation*. Vol.AP-34, March, 1986, pp.276–280.
- [3] Stoica, Petre, and Randolph L. Moses. *Spectral Analysis of Signals*. Upper Saddle River, NJ: Prentice Hall, 2005.

See Also

corrmtx | pmtm | pmusic | prony | pwelch | pburg | periodogram | rooteig | rootmusic

Introduced before R2006a

periodogram

Periodogram power spectral density estimate

Syntax

```
pxx = periodogram(x)
pxx = periodogram(x,window)
pxx = periodogram(x,window,nfft)

[pxx,w] = periodogram( ___ )
[pxx,f] = periodogram( ___ ,fs)

[pxx,w] = periodogram(x,window,w)
[pxx,f] = periodogram(x,window,f,fs)

[ ___ ] = periodogram(x,window, ___ ,freqrange)
[ ___ ] = periodogram(x,window, ___ ,spectrumtype)

[ ___ ,pxxc] = periodogram( ___ , 'ConfidenceLevel',probability)

[rpxx,f] = periodogram( ___ , 'reassigned')
[rpxx,f,pxx,fc] = periodogram( ___ , 'reassigned')

periodogram( ___ )
```

Description

`pxx = periodogram(x)` returns the periodogram power spectral density (PSD) estimate, `pxx`, of the input signal, `x`, found using a rectangular window. When `x` is a vector, it is treated as a single channel. When `x` is a matrix, the PSD is computed independently for each column and stored in the corresponding column of `pxx`. If `x` is real-valued, `pxx` is a one-sided PSD estimate. If `x` is complex-valued, `pxx` is a two-sided PSD estimate. The number of points, `nfft`, in the discrete Fourier transform (DFT) is the maximum of 256 or the next power of two greater than the signal length.

`pxx = periodogram(x,window)` returns the modified periodogram PSD estimate using the window, `window`. `window` is a vector the same length as `x`.

`pxx = periodogram(x,window,nfft)` uses `nfft` points in the discrete Fourier transform (DFT). If `nfft` is greater than the signal length, `x` is zero-padded to length `nfft`. If `nfft` is less than the signal length, the signal is wrapped modulo `nfft` and summed using `datawrap`. For example, the input signal `[1 2 3 4 5 6 7 8]` with `nfft` equal to 4 results in the periodogram of `sum([1 5; 2 6; 3 7; 4 8],2)`.

`[pxx,w] = periodogram(___)` returns the normalized frequency vector, `w`. If `pxx` is a one-sided periodogram, `w` spans the interval $[0,\pi]$ if `nfft` is even and $[0,\pi)$ if `nfft` is odd. If `pxx` is a two-sided periodogram, `w` spans the interval $[0,2\pi)$.

`[pxx,f] = periodogram(___,fs)` returns a frequency vector, `f`, in cycles per unit time. The sampling frequency, `fs`, is the number of samples per unit time. If the unit of time is seconds, then `f` is in cycles/second (Hz). For real-valued signals, `f` spans the interval $[0,fs/2]$ when `nfft` is even and $[0,fs/2)$ when `nfft` is odd. For complex-valued signals, `f` spans the interval $[0,fs)$. `fs` must be the fourth input to `periodogram`. To input a sample rate and still use the default values of the preceding optional arguments, specify these arguments as empty, `[]`.

`[pxx,w] = periodogram(x,window,w)` returns the two-sided periodogram estimates at the normalized frequencies specified in the vector, `w`. `w` must contain at least two elements.

`[pxx,f] = periodogram(x,window,f,fs)` returns the two-sided periodogram estimates at the frequencies specified in the vector, `f`. `f` must contain at least two elements. The frequencies in `f` are in cycles per unit time. The sampling frequency, `fs`, is the number of samples per unit time. If the unit of time is seconds, then `f` is in cycles/second (Hz).

`[___] = periodogram(x,window, ___,freqrange)` returns the periodogram over the frequency range specified by `freqrange`. Valid options for `freqrange` are: `'onesided'`, `'twosided'`, or `'centered'`.

`[___] = periodogram(x,window, ___,spectrumtype)` returns the PSD estimate if `spectrumtype` is specified as `'psd'` and returns the power spectrum if `spectrumtype` is specified as `'power'`.

`[___,pxxc] = periodogram(___, 'ConfidenceLevel',probability)` returns the `probability` \times 100% confidence intervals for the PSD estimate in `pxxc`.

`[rpxx,f] = periodogram(___, 'reassigned')` reassigns each PSD estimate to the frequency closest to its center of energy. `rpxx` contains the sum of the estimates reassigned to each element of `f`.

`[rpxx,f,pxx,fc] = periodogram(____, 'reassigned')` also returns the nonreassigned PSD estimates, `pxx`, and the center-of-energy frequencies, `fc`. If you use the 'reassigned' flag, then you cannot specify a probability confidence interval.

`periodogram(____,)` with no output arguments plots the periodogram PSD estimate in dB per unit frequency in the current figure window.

Examples

Periodogram Using Default Inputs

Obtain the periodogram of an input signal consisting of a discrete-time sinusoid with an angular frequency of $\pi/4$ rad/sample with additive $N(0,1)$ white noise.

Create a sine wave with an angular frequency of $\pi/4$ rad/sample with additive $N(0,1)$ white noise. The signal is 320 samples in length. Obtain the periodogram using the default rectangular window and DFT length. The DFT length is the next power of two greater than the signal length, or 512 points. Because the signal is real-valued and has even length, the periodogram is one-sided and there are $512/2+1$ points.

```
n = 0:319;  
x = cos(pi/4*n)+randn(size(n));  
[pxx,w] = periodogram(x);  
plot(w,10*log10(pxx))
```

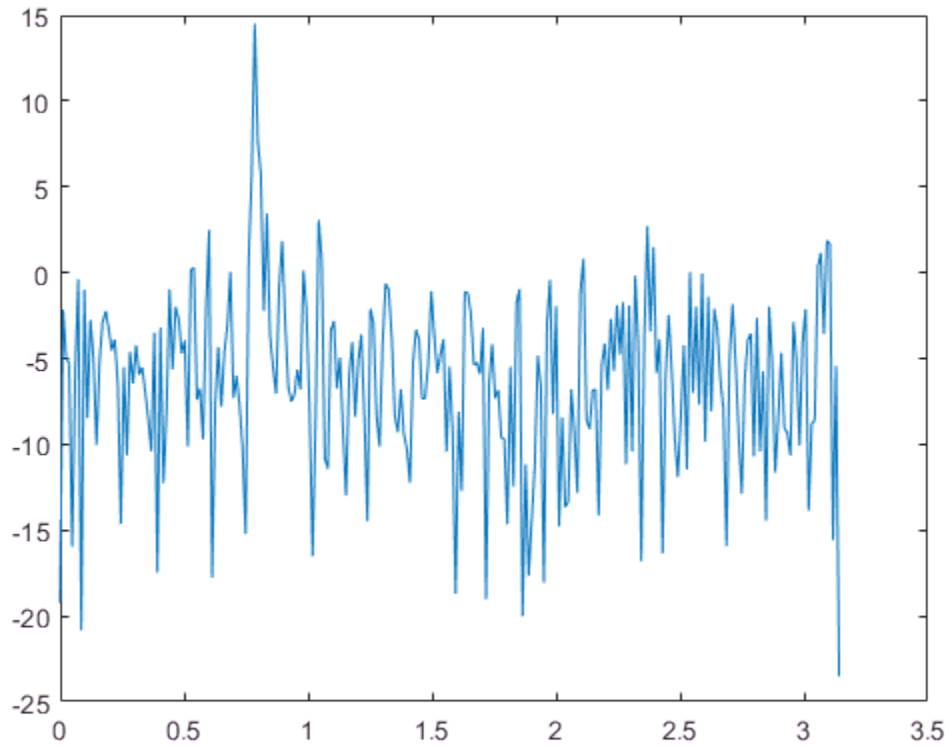
Repeat the plot using `periodogram` with no outputs.

```
periodogram(x)
```

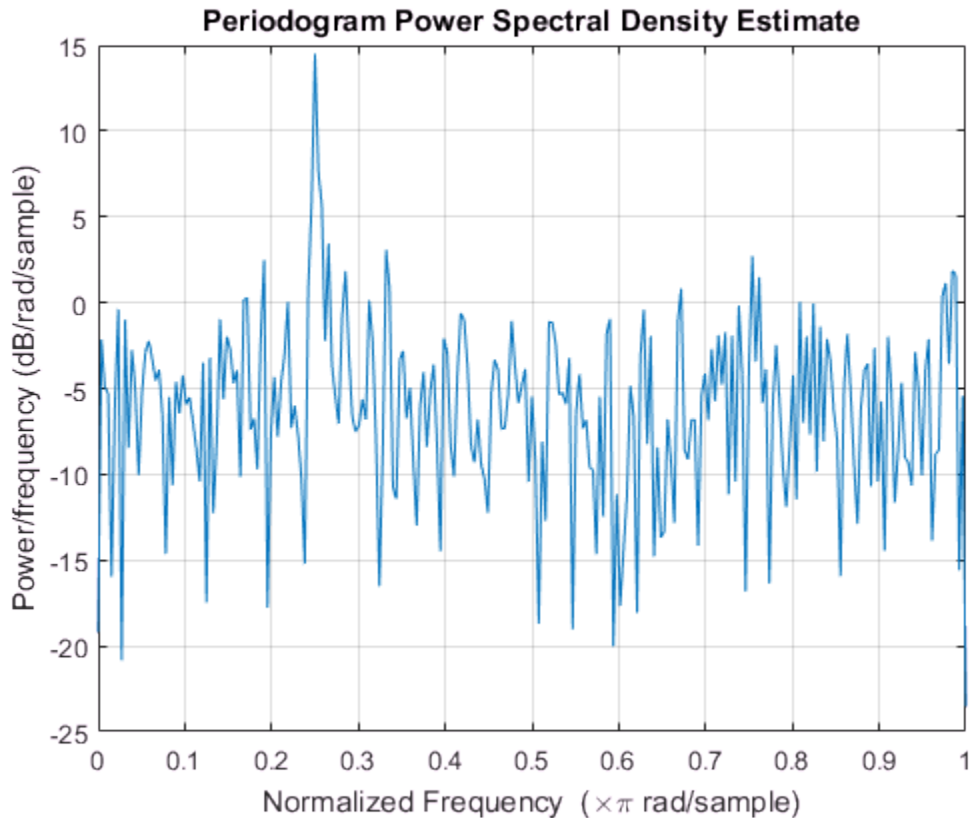

Modified Periodogram with Hamming Window

Obtain the modified periodogram of an input signal consisting of a discrete-time sinusoid with an angular frequency of $\pi/4$ radians/sample with additive $N(0, 1)$ white noise.

Create a sine wave with an angular frequency of $\pi/4$ radians/sample with additive $N(0, 1)$ white noise. The signal is 320 samples in length. Obtain the modified periodogram using a Hamming window and default DFT length. The DFT length is the next power of two greater than the signal length, or 512 points. Because the signal is real-valued and has even length, the periodogram is one-sided and there are $512/2+1$ points.

```
n = 0:319;
x = cos(pi/4*n)+randn(size(n));
periodogram(x,hamming(length(x)))
```

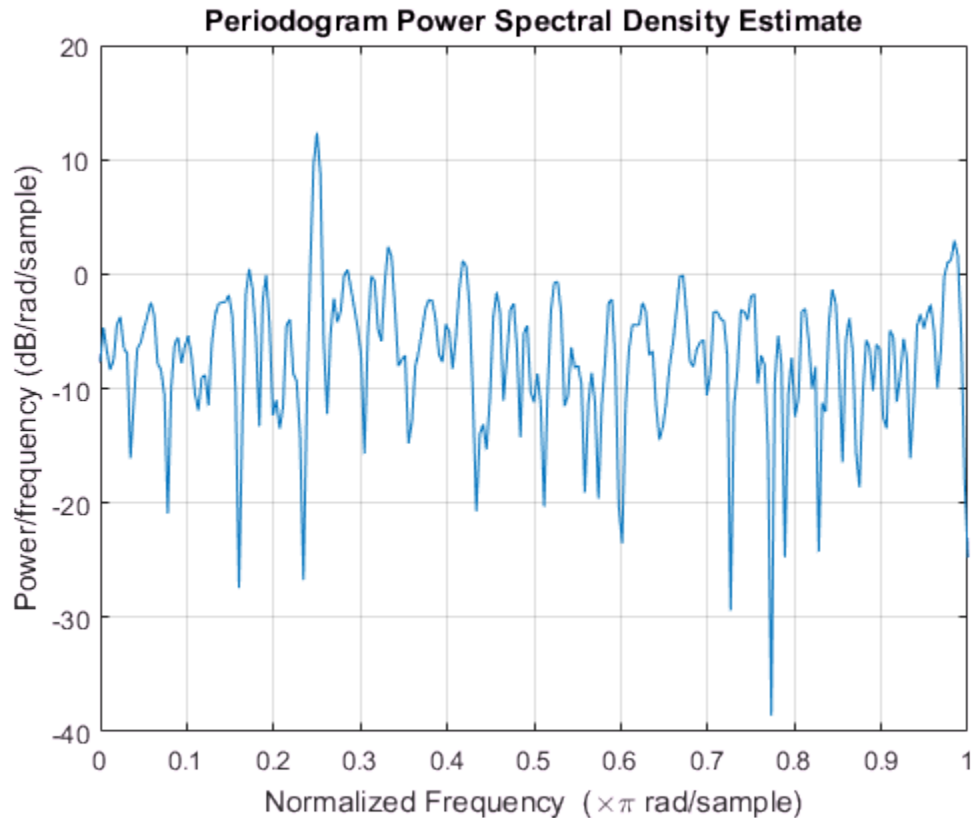

DFT Length Equal to Signal Length

Obtain the periodogram of an input signal consisting of a discrete-time sinusoid with an angular frequency of $\pi/4$ radians/sample with additive $N(0,1)$ white noise. Use a DFT length equal to the signal length.

Create a sine wave with an angular frequency of $\pi/4$ radians/sample with additive $N(0,1)$ white noise. The signal is 320 samples in length. Obtain the periodogram using

the default rectangular window and DFT length equal to the signal length. Because the signal is real-valued, the one-sided periodogram is returned by default with a length equal to $320/2+1$.

```
n = 0:319;  
x = cos(pi/4*n)+randn(size(n));  
nfft = length(x);  
periodogram(x,[],nfft)
```

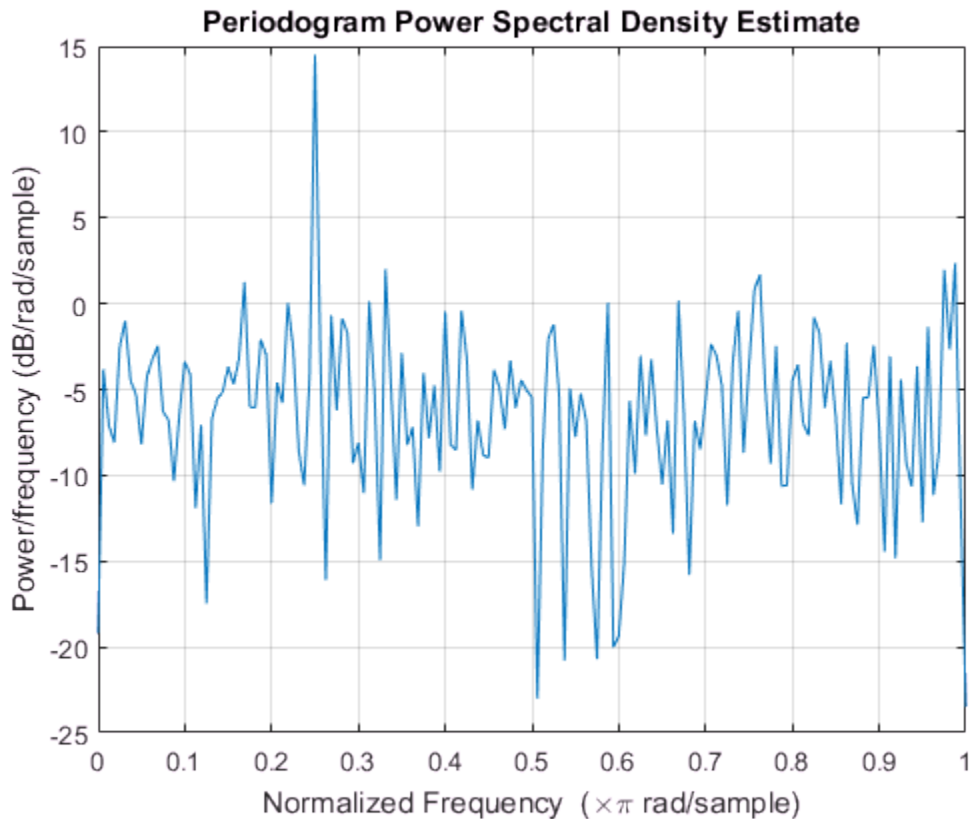

Periodogram of Relative Sunspot Numbers

Obtain the periodogram of the Wolf (relative sunspot) number data sampled yearly between 1700 and 1987.

Load the relative sunspot number data. Obtain the periodogram using the default rectangular window and number of DFT points (512 in this example). The sample rate for these data is 1 sample/year. Plot the periodogram.

```
load sunspot.dat
relNums=sunspot(:,2);

[pxx,f] = periodogram(relNums,[],[],1);
plot(f,10*log10(pxx))
xlabel('Cycles/Year')
ylabel('dB')
title('Periodogram of Relative Sunspot Number Data')
```

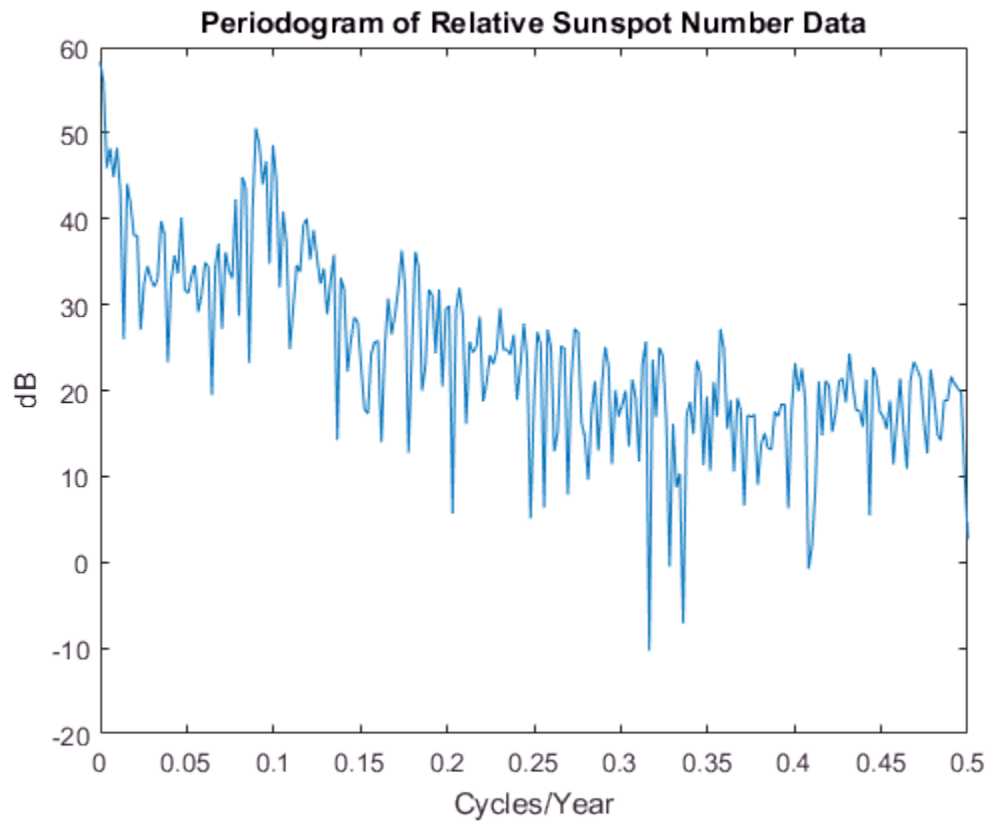

You see in the preceding figure that there is a peak in the periodogram at approximately 0.1 cycles/year, which indicates a period of approximately 10 years.

Periodogram at a Given Set of Normalized Frequencies

Obtain the periodogram of an input signal consisting of two discrete-time sinusoids with an angular frequencies of $\pi/4$ and $\pi/2$ rad/sample in additive $N(0, 1)$ white noise.

Obtain the two-sided periodogram estimates at $\pi/4$ and $\pi/2$ rad/sample. Compare the result to the one-sided periodogram.

```
n = 0:319;
x = cos(pi/4*n)+0.5*sin(pi/2*n)+randn(size(n));

[pxx,w] = periodogram(x,[],[pi/4 pi/2]);
pxx

pxx =

    14.0589    2.8872

[pxx1,w1] = periodogram(x);
plot(w1/pi,pxx1,w/pi,2*pxx,'o')
legend('pxx1','2 * pxx')
xlabel('\omega / \pi')
```

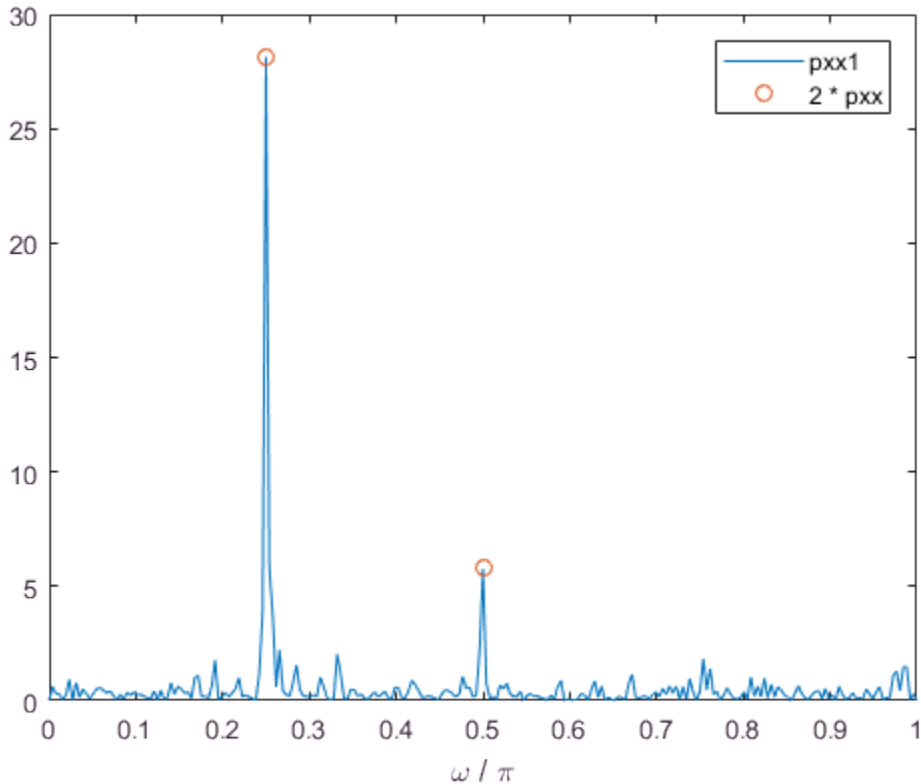

The periodogram values obtained are 1/2 the values in the one-sided periodogram. When you evaluate the periodogram at a specific set of frequencies, the output is a two-sided estimate.

Periodogram at a Given Set of Cyclical Frequencies

Create a signal consisting of two sine waves with frequencies of 100 and 200 Hz in $N(0,1)$ white additive noise. The sampling frequency is 1 kHz. Obtain the two-sided periodogram at 100 and 200 Hz.

```
fs = 1000;
t = 0:0.001:1-0.001;
x = cos(2*pi*100*t)+sin(2*pi*200*t)+randn(size(t));
```

```
freq = [100 200];
pxx = periodogram(x, [], freq, fs)

pxx =

    0.2647    0.2313
```

Upper and Lower 95%-Confidence Bounds

The following example illustrates the use of confidence bounds with the periodogram. While not a necessary condition for statistical significance, frequencies in the periodogram where the lower confidence bound exceeds the upper confidence bound for surrounding PSD estimates clearly indicate significant oscillations in the time series.

Create a signal consisting of the superposition of 100 Hz and 150 Hz sine waves in additive white $N(0,1)$ noise. The amplitude of the two sine waves is 1. The sampling frequency is 1 kHz.

```
fs = 1000;
t = 0:0.001:1-0.001;
x = cos(2*pi*100*t)+sin(2*pi*150*t)+randn(size(t));
```

Obtain the periodogram with 95%-confidence bounds. Plot the periodogram along with the confidence interval and zoom in on the frequency region of interest near 100 and 150 Hz.

```
[pxx,f,pxxc] = periodogram(x,rectwin(length(x)),length(x),fs,...
    'ConfidenceLevel', 0.95);

plot(f,10*log10(pxx))
hold on
plot(f,10*log10(pxxc),'r-.')

xlim([85 175])
xlabel('Hz')
ylabel('dB')
title('Periodogram with 95%-Confidence Bounds')
```

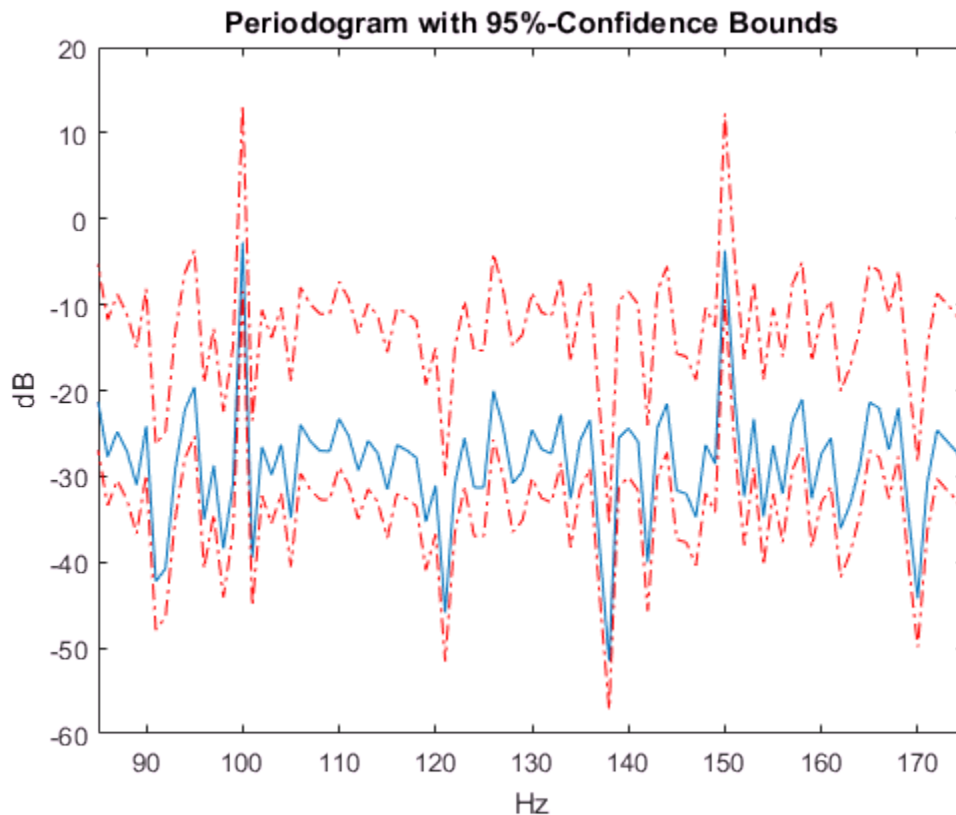
The lower confidence bound in the immediate vicinity of 100 and 150 Hz is significantly above the upper confidence bound outside the vicinity of 100 and 150 Hz.

Power Estimate of Sinusoid

Estimate the power of sinusoid at a specific frequency using the 'power' option.

Create a 100 Hz sinusoid one second in duration sampled at 1 kHz. The amplitude of the sine wave is 1.8, which equates to a power of $1.8^2/2 = 1.62$. Estimate the power using the 'power' option.

```
fs = 1000;
```

```
t = 0:1/fs:1-1/fs;
x = 1.8*cos(2*pi*100*t);
[pxx,f] = periodogram(x,hamming(length(x)),length(x),fs,'power');
[pwrest,idx] = max(pxx);
fprintf('The maximum power occurs at %3.1f Hz\n',f(idx))
```

The maximum power occurs at 100.0 Hz

```
fprintf('The power estimate is %2.2f\n',pwrest)
```

The power estimate is 1.62

DC-Centered Periodogram

Obtain the periodogram of a 100 Hz sine wave in additive $N(0,1)$ noise. The data are sampled at 1 kHz. Use the 'centered' option to obtain the DC-centered periodogram and plot the result.

```
fs = 1000;
t = 0:0.001:1-0.001;
x = cos(2*pi*100*t)+randn(size(t));
periodogram(x,[],length(x),fs,'centered')
```

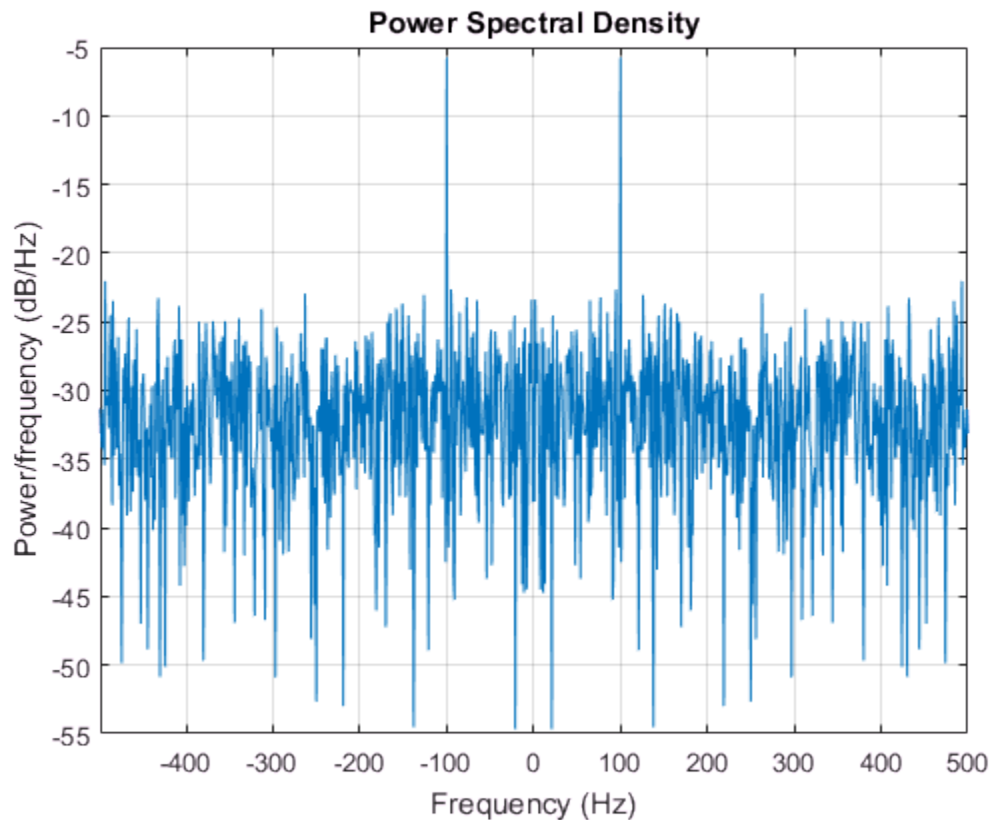

Reassigned Periodogram

Generate a signal that consists of a 200 Hz sinusoid embedded in white Gaussian noise. The signal is sampled at 1 kHz for 1 second. The noise has a variance of 0.01^2 . Reset the random number generator for reproducible results.

```
rng('default')  
  
Fs = 1000;  
t = 0:1/Fs:1-1/Fs;  
N = length(t);  
x = sin(2*pi*t*200)+0.01*randn(size(t));
```

Use the FFT to compute the power spectrum of the signal, normalized by the signal length. The sinusoid is in-bin, so all the power is concentrated in a single frequency sample. Plot the one-sided spectrum. Zoom in to the vicinity of the peak.

```
q = fft(x,N);  
ff = 0:Fs/N:Fs-Fs/N;  
  
ffts = q*q'/N^2  
  
ffts = 0.4997  
  
ff = ff(1:floor(N/2)+1);  
q = q(1:floor(N/2)+1);  
  
stem(ff,abs(q)/N, '*')  
axis([190 210 0 0.55])
```

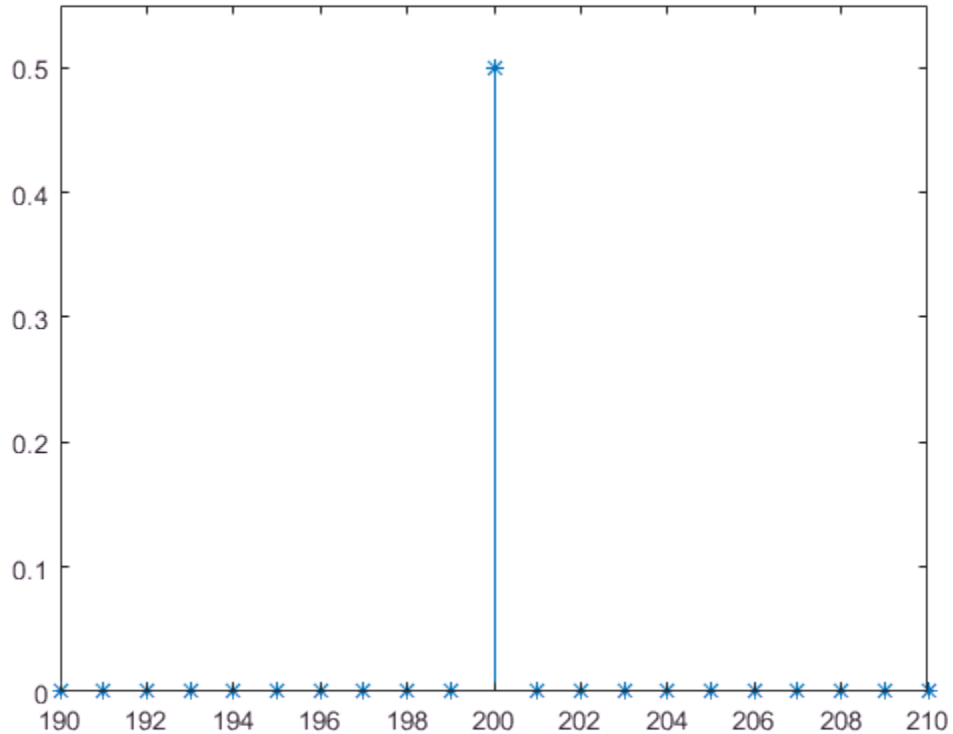

Use `periodogram` to compute the power spectrum of the signal. Specify a Hann window and an FFT length of 1024. Find the percentage difference between the estimated power at 200 Hz and the actual value.

```
wind = hann(N);
```

```
[pun,fr] = periodogram(x,wind,1024,Fs, 'power');
```

```
hold on  
stem(fr,pun)
```

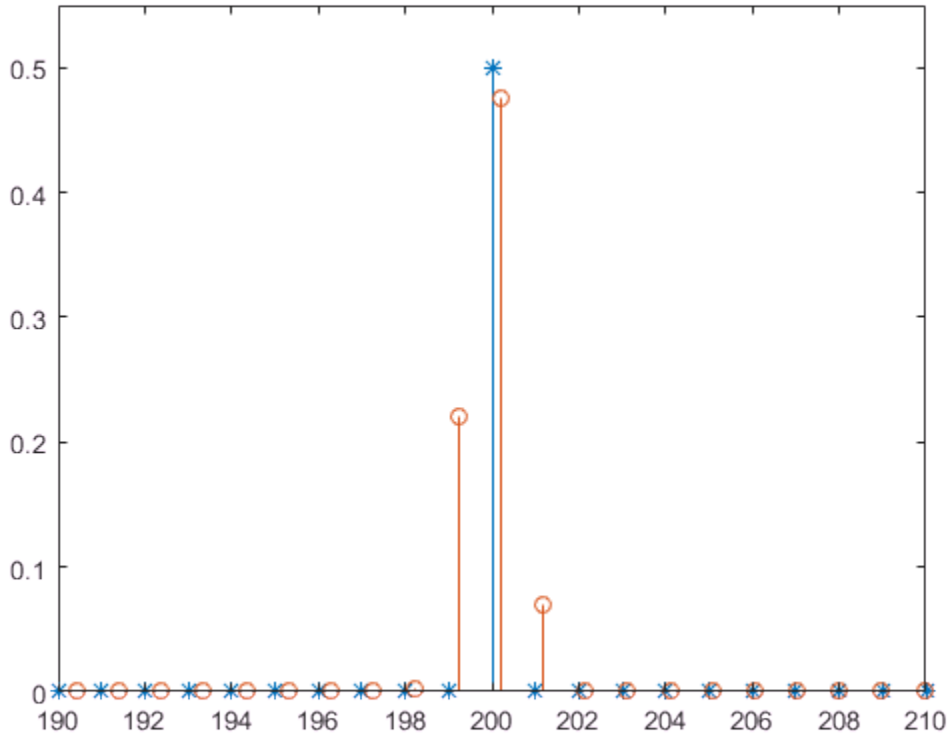

```
periodogErr = abs(max(pun)-ffts)/ffts*100
```

```
periodogErr = 4.7349
```

Recompute the power spectrum, but this time use reassignment. Plot the new estimate and compare its maximum with the FFT value.

```
[pre,ft,pxx,fx] = periodogram(x,wind,1024,Fs,'power','reassigned');
```

```
stem(fx,pre)
```

```
hold off
```

```
legend('Original','Periodogram','Reassigned')
```

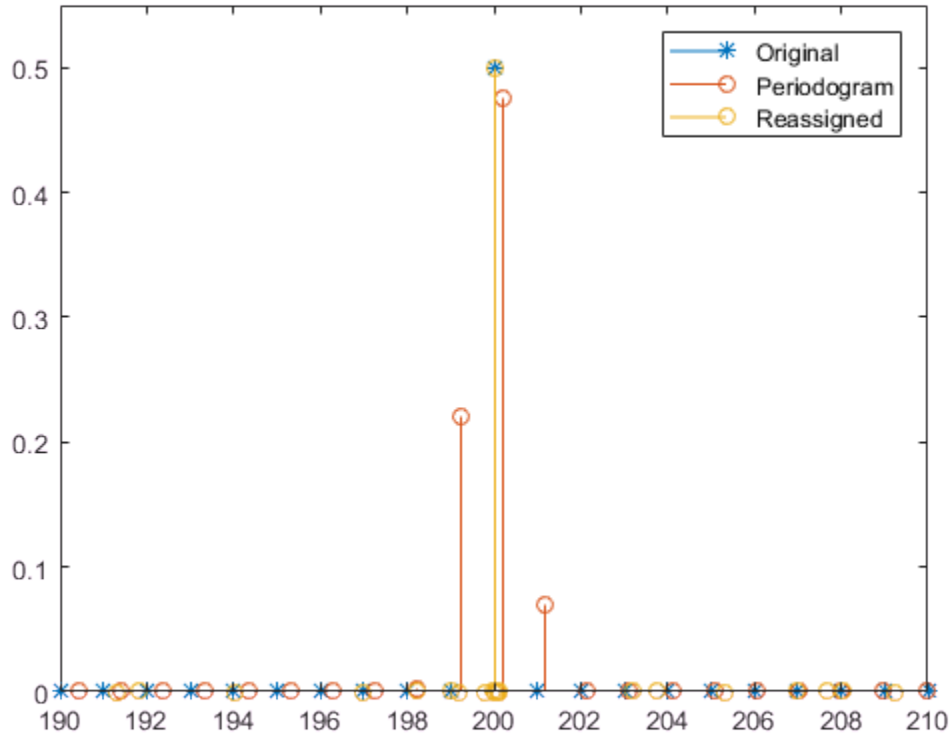

```
reassignErr = abs(max(pre)-ffts)/ffts*100
```

```
reassignErr = 0.0779
```

Periodogram PSD Estimate of a Multichannel Signal

Generate 1024 samples of a multichannel signal consisting of three sinusoids in additive $N(0, 1)$ white Gaussian noise. The sinusoids' frequencies are $\pi/2$, $\pi/3$, and $\pi/4$ rad/sample. Estimate the PSD of the signal using the periodogram and plot it.

```
N = 1024;
```

```
n = 0:N-1;  
w = pi./[2;3;4];  
x = cos(w*n)' + randn(length(n),3);  
periodogram(x)
```

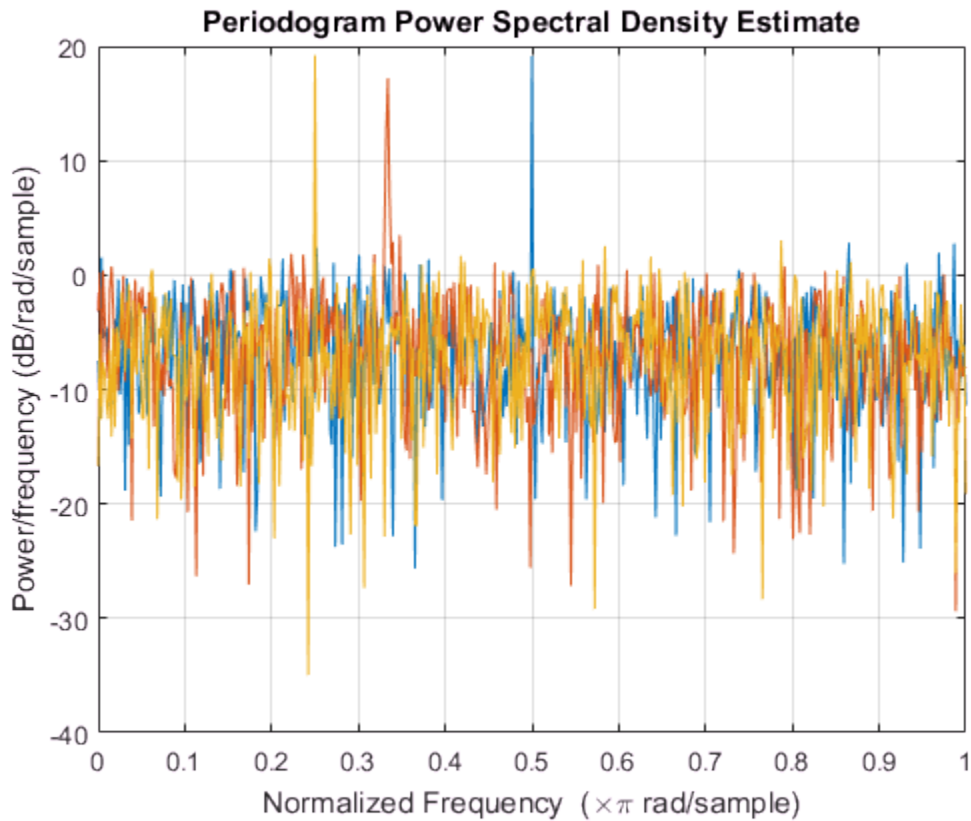

- “Bias and Variability in the Periodogram”
- “Power Spectral Density Estimates Using FFT”

Input Arguments

x — Input signal

vector | matrix

Input signal, specified as a row or column vector, or as a matrix. If **x** is a matrix, then its columns are treated as independent channels.

Example: `cos(pi/4*(0:159))+randn(1,160)` is a single-channel row-vector signal.

Example: `cos(pi./[4;2]*(0:159))'+randn(160,2)` is a two-channel signal.

Data Types: `single` | `double`

Complex Number Support: Yes

window — Window

`rectwin(length(x))` | `kaiser(length(x),38)` | vector | []

Window, specified as a row or column vector with the same length as the input signal. If you specify **window** as empty, then `periodogram` uses a rectangular window. If you specify the `'reassigned'` flag and an empty **window**, then the function uses a Kaiser window with $\beta = 38$.

Data Types: `single` | `double`

nfft — Number of DFT points

`max(256,2^nextpow2(length(x)))` (default) | integer | []

Number of DFT points, specified as a positive integer. For a real-valued input signal, **x**, the PSD estimate, **pxx** has length $(nfft/2 + 1)$ if **nfft** is even, and $(nfft + 1)/2$ if **nfft** is odd. For a complex-valued input signal, **x**, the PSD estimate always has length **nfft**. If **nfft** is specified as empty, the default **nfft** is used.

Data Types: `single` | `double`

fs — Sample rate

positive scalar

Sample rate, specified as a positive scalar. The sample rate is the number of samples per unit time. If the unit of time is seconds, then the sample rate has units of Hz.

w — Normalized frequencies

vector

Normalized frequencies, specified as a row or column vector with at least two elements. Normalized frequencies are in rad/sample.

Example: `w = [pi/4 pi/2]`

Data Types: `double`

f — Frequencies

vector

Frequencies, specified as a row or column vector with at least two elements. The frequencies are in cycles per unit time. The unit time is specified by the sample rate, `fs`. If `fs` has units of samples/second, then `f` has units of Hz.

Example: `fs = 1000; f = [100 200]`

Data Types: `double`

freorange — Frequency range for PSD estimate

`'onesided'` | `'twosided'` | `'centered'`

Frequency range for the PSD estimate, specified as a one of `'onesided'`, `'twosided'`, or `'centered'`. The default is `'onesided'` for real-valued signals and `'twosided'` for complex-valued signals. The frequency ranges corresponding to each option are

- `'onesided'` — returns the one-sided PSD estimate of a real-valued input signal, `x`. If `nfft` is even, `pxx` has length $nfft/2 + 1$ and is computed over the interval $[0, \pi]$ rad/sample. If `nfft` is odd, the length of `pxx` is $(nfft + 1)/2$ and the interval is $[0, \pi)$ rad/sample. When `fs` is optionally specified, the corresponding intervals are $[0, fs/2]$ cycles/unit time and $[0, fs/2)$ cycles/unit time for even and odd length `nfft` respectively.
- `'twosided'` — returns the two-sided PSD estimate for either the real-valued or complex-valued input, `x`. In this case, `pxx` has length `nfft` and is computed over the interval $[0, 2\pi)$ rad/sample. When `fs` is optionally specified, the interval is $[0, fs)$ cycles/unit time.
- `'centered'` — returns the centered two-sided PSD estimate for either the real-valued or complex-valued input, `x`. In this case, `pxx` has length `nfft` and is computed over the interval $(-\pi, \pi]$ rad/sample for even length `nfft` and $(-\pi, \pi)$ rad/sample for odd length `nfft`. When `fs` is optionally specified, the corresponding intervals are $(-fs/2, fs/2]$ cycles/unit time and $(-fs/2, fs/2)$ cycles/unit time for even and odd length `nfft` respectively.

Data Types: `char`

spectrumtype — Power spectrum scaling

'psd' (default) | 'power'

Power spectrum scaling, specified as 'psd' or 'power'. To return the power spectral density, omit `spectrumtype` or specify 'psd'. To obtain an estimate of the power at each frequency, use 'power' instead. Specifying 'power' scales each estimate of the PSD by the equivalent noise bandwidth of the window, except when the 'reassigned' flag is used.

Data Types: char

probability — Confidence interval for PSD estimate

0.95 (default) | scalar in the range (0,1)

Coverage probability for the true PSD, specified as a scalar in the range (0,1). The output, `pxxc`, contains the lower and upper bounds of the `probability` × 100% interval estimate for the true PSD.

Output Arguments

pxx — PSD estimate

vector | matrix

PSD estimate, returned as a real-valued, nonnegative column vector or matrix. Each column of `pxx` is the PSD estimate of the corresponding column of `x`. The units of the PSD estimate are in squared magnitude units of the time series data per unit frequency. For example, if the input data is in volts, the PSD estimate is in units of squared volts per unit frequency. For a time series in volts, if you assume a resistance of 1 Ω and specify the sample rate in hertz, the PSD estimate is in watts per hertz.

Data Types: single | double

w — Normalized frequencies

vector

Normalized frequencies, returned as a real-valued column vector. If `pxx` is a one-sided PSD estimate, `w` spans the interval $[0,\pi]$ if `nfft` is even and $[0,\pi)$ if `nfft` is odd. If `pxx` is a two-sided PSD estimate, `w` spans the interval $[0,2\pi)$. For a DC-centered PSD estimate, `w` spans the interval $(-\pi,\pi]$ for even `nfft` and $(-\pi,\pi)$ for odd `nfft`.

Data Types: double

f — Cyclical frequencies

vector

Cyclical frequencies, returned as a real-valued column vector. For a one-sided PSD estimate, f spans the interval $[0, f_s/2]$ when $nfft$ is even and $[0, f_s/2)$ when $nfft$ is odd. For a two-sided PSD estimate, f spans the interval $[0, f_s)$. For a DC-centered PSD estimate, f spans the interval $(-f_s/2, f_s/2]$ cycles/unit time for even length $nfft$ and $(-f_s/2, f_s/2)$ cycles/unit time for odd length $nfft$.

Data Types: double

pxxc — Confidence bounds

matrix

Confidence bounds, returned as a matrix with real-valued elements. The row size of the matrix is equal to the length of the PSD estimate, pxx . $pxxc$ has twice as many columns as pxx . Odd-numbered columns contain the lower bounds of the confidence intervals, and even-numbered columns contain the upper bounds. Thus, $pxxc(m, 2*n - 1)$ is the lower confidence bound and $pxxc(m, 2*n)$ is the upper confidence bound corresponding to the estimate $pxx(m, n)$. The coverage probability of the confidence intervals is determined by the value of the probability input.

Data Types: single | double

rpxx — Reassigned PSD estimate

vector | matrix

Reassigned PSD estimate, returned as a real-valued, nonnegative column vector or matrix. Each column of $rpxx$ is the reassigned PSD estimate of the corresponding column of x .

fc — Center-of-energy frequencies

vector | matrix

Center-of-energy frequencies, specified as a vector or matrix.

Definitions

Periodogram

The periodogram is a nonparametric estimate of the power spectral density (PSD) of a wide-sense stationary random process. The periodogram is the Fourier transform of the

biased estimate of the autocorrelation sequence. For a signal, x_n , sampled at f_s samples per unit time, the periodogram is defined as

$$\hat{P}(f) = \frac{\Delta t}{N} \left| \sum_{n=0}^{N-1} x_n e^{-i2\pi fn} \right|^2, \quad -1/2\Delta t < f \leq 1/2\Delta t,$$

where Δt is the sampling interval. For a one-sided periodogram, the values at all frequencies except 0 and the Nyquist, $1/2\Delta t$, are multiplied by 2 so that the total power is conserved.

If the frequencies are in radians/sample, the periodogram is defined as

$$\hat{P}(f) = \frac{1}{2\pi N} \left| \sum_{n=0}^{N-1} x_n e^{-i\omega n} \right|^2, \quad -\pi < \omega \leq \pi.$$

The frequency range in the preceding equations has variations depending on the value of the `freqrange` argument. See the description of `freqrange` in “Input Arguments” on page 1-1467.

The integral of the true PSD, $P(f)$, over one period, $1/\Delta t$ for cyclical frequency and 2π for normalized frequency, is equal to the variance of the wide-sense stationary random process:

$$\sigma^2 = \int_{-1/2\Delta t}^{1/2\Delta t} P(f) df.$$

For normalized frequencies, replace the limits of integration appropriately.

Modified Periodogram

The modified periodogram multiplies the input time series by a window function. A suitable window function is nonnegative and decays to zero at the beginning and end points. Multiplying the time series by the window function *tapers* the data gradually on and off and helps to alleviate the leakage in the periodogram. See “Bias and Variability in the Periodogram” for an example.

If h_n is a window function, the modified periodogram is defined by

$$\hat{P}(f) = \frac{\Delta t}{N} \left| \sum_{n=0}^{N-1} h_n x_n e^{-i2\pi f n} \right|^2, \quad -1/2\Delta t < f \leq 1/2\Delta t,$$

where Δt is the sampling interval.

If the frequencies are in radians/sample, the modified periodogram is defined as

$$\hat{P}(f) = \frac{1}{2\pi N} \left| \sum_{n=0}^{N-1} h_n x_n e^{-i\omega n} \right|^2, \quad -\pi < \omega \leq \pi.$$

The frequency range in the preceding equations has variations depending on the value of the `f`reqrange argument. See the description of `f`reqrange in “Input Arguments” on page 1-1467.

Reassigned Periodogram

The reassignment technique sharpens the localization of spectral estimates and produces periodograms that are easier to read and interpret. This technique reassigns each PSD estimate to the center of energy of its bin, away from the bin’s geometric center. It provides exact localization for chirps and impulses.

References

- [1] Fulop, Sean A., and Kelly Fitz. “Algorithms for computing the time-corrected instantaneous frequency (reassigned) spectrogram, with applications.” *Journal of the Acoustical Society of America*. Vol.119, January 2006, pp.360–371.
- [2] Auger, François, and Patrick Flandrin. “Improving the Readability of Time-Frequency and Time-Scale Representations by the Reassignment Method.” *IEEE Transactions on Signal Processing*. Vol.43, May 1995, pp.1068–1089.

See Also

See Also

bandpower | pburg | pcov | plomb | pmcov | pmtm | pwelch | sfdr

Topics

“Bias and Variability in the Periodogram”

“Power Spectral Density Estimates Using FFT”

“Nonparametric Methods”

Introduced before R2006a

phasedelay

Phase delay of digital filter

Syntax

```
[phi,w] = phasedelay(b,a,n)
[phi,w] = phasedelay(sos,n)
[phi,w] = phasedelay(d,n)
[phi,w] = phasedelay(...,n,'whole')
phi = phasedelay(...,w)
[phi,f] = phasedelay(...,n,fs)
[phi,f] = phasedelay(...,n,'whole',fs)
phi = phasedelay(...,f,fs)
[phi,w,s] = phasedelay(...)
[phi,f,s] = phasedelay(...)
phasedelay(...)
```

Description

`[phi,w] = phasedelay(b,a,n)` returns the n -point phase delay response vector, `phi`, and the n -point frequency vector in radians/sample, `w`, of the filter defined by numerator coefficients, `b`, and denominator coefficients, `a`. The phase delay response is evaluated at n equally spaced points around the upper half of the unit circle. If n is omitted, it defaults to 512. For best results, set n to a value greater than the filter order.

`[phi,w] = phasedelay(sos,n)` returns the n -point phase delay response for the second-order sections matrix, `sos`. `sos` is a K -by-6 matrix, where the number of sections, K , must be greater than or equal to 2. If the number of sections is less than 2, `phasedelay` considers the input to be a numerator vector, `b`. Each row of `sos` corresponds to the coefficients of a second order (biquad) filter. The i th row of the `sos` matrix corresponds to `[bi(1) bi(2) bi(3) ai(1) ai(2) ai(3)]`.

`[phi,w] = phasedelay(d,n)` returns the n -point phase delay response of the digital filter, `d`. Use `designfilt` to generate `d` based on frequency-response specifications.

`[phi,w] = phasedelay(...,n,'whole')` uses n equally spaced points around the whole unit circle.

`phi = phasedelay(...,w)` returns the phase delay response at frequencies specified, in radians/sample, in vector `w`. The frequencies are normally between 0 and π . `w` must contain at least two elements.

`[phi,f] = phasedelay(...,n,fs)` and `[phi,f] = phasedelay(...,n,'whole',fs)` return the phase delay vector `f` (in Hz), using the sampling frequency `fs` (in Hz). `f` must contain at least two elements.

`phi = phasedelay(...,f,fs)` returns the phase delay response at the frequencies specified in vector `f` (in Hz), using the sampling frequency `fs` (in Hz).

`[phi,w,s] = phasedelay(...)` and `[phi,f,s] = phasedelay(...)` return plotting information, where `s` is a structure with fields you can change to display different frequency response plots.

`phasedelay(...)` with no output arguments plots the phase delay response versus frequency.

Note: If the input to `phasedelay` is single precision, the phase delay response is calculated using single-precision arithmetic. The output, `phi`, is single precision.

Examples

Phase Delay Response of an FIR Filter

Use constrained least squares to design a lowpass FIR filter of order 54 and normalized cutoff frequency 0.3. Specify the passband ripple and stopband attenuation as 0.02 and 0.08, respectively, expressed in linear units. Compute and plot the phase delay response of the filter.

```
Ap = 0.02;  
As = 0.008;
```

```
b = fircls1(54,0.3,Ap,As);  
phasedelay(b)
```

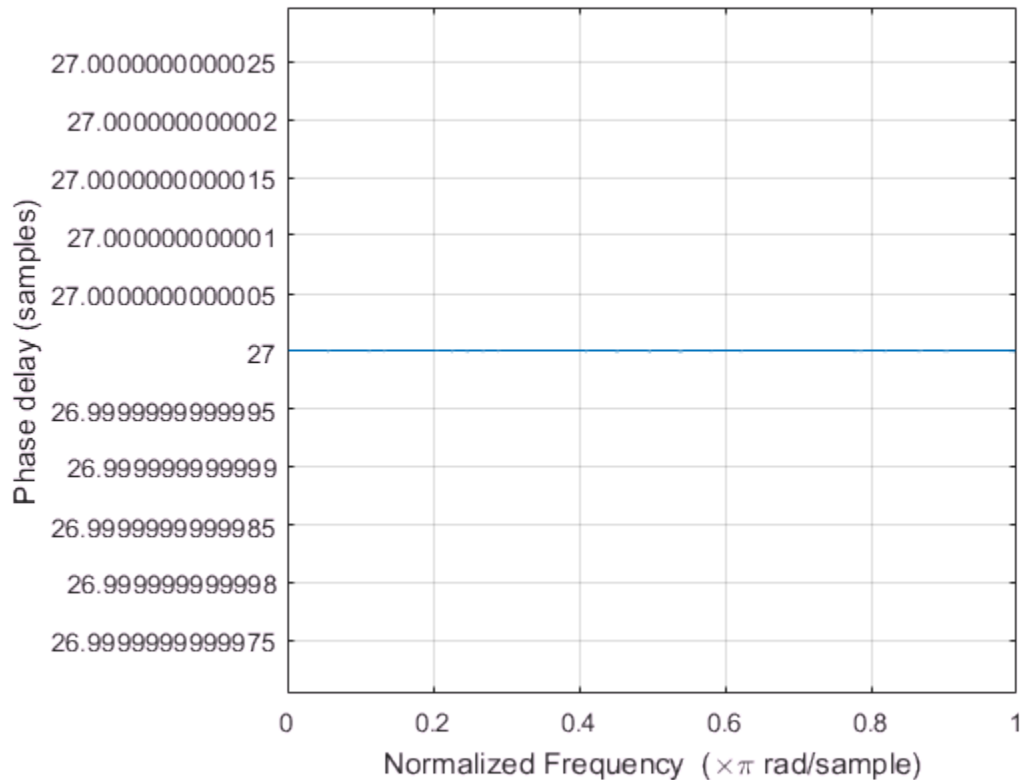

Repeat the example using `designfilt`. Keep in mind that this function expresses the ripples in decibels.

```
Apd = 40*log10((1+Ap)/(1-Ap));
Asd = -20*log10(As);

d = designfilt('lowpassfir','FilterOrder',54,'CutoffFrequency',0.3, ...
              'PassbandRipple',Apd,'StopbandAttenuation',Asd);
phasedelay(d)
```

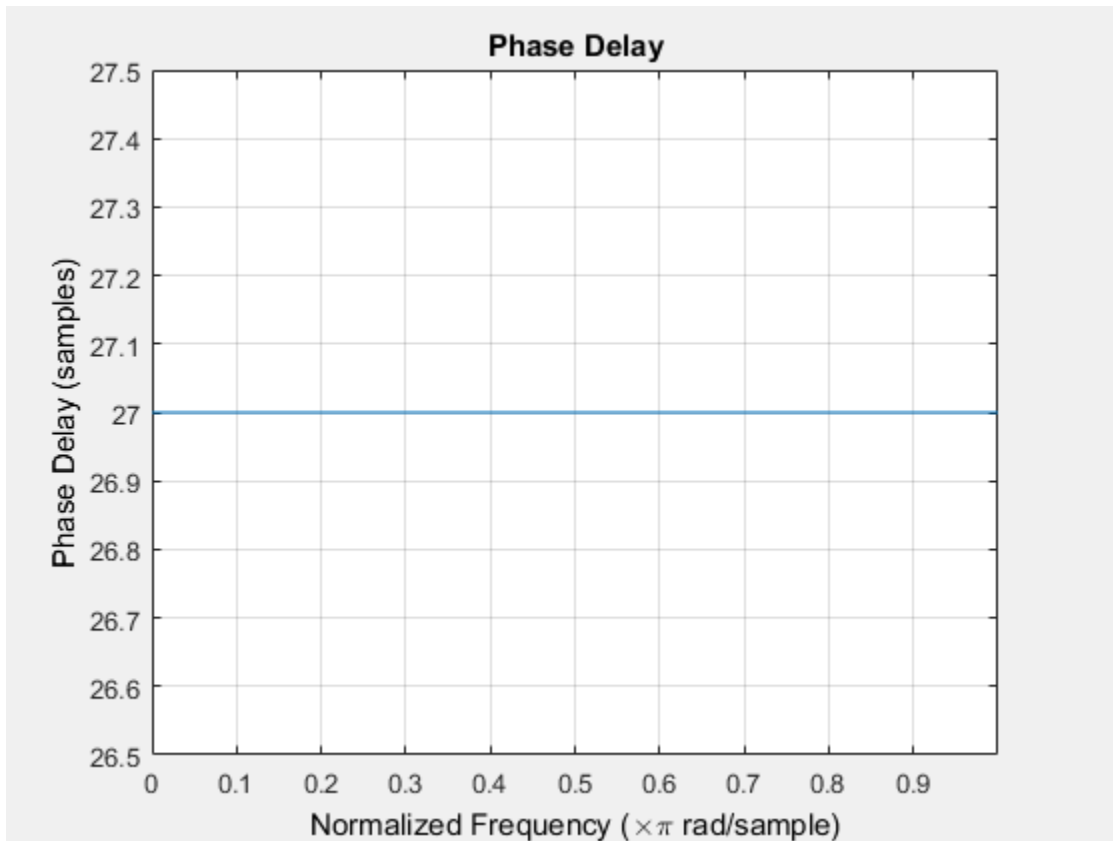

Phase Delay Response of an Elliptic Filter

Design an elliptic filter of order 10 and normalized passband frequency 0.4. Specify a passband ripple of 0.5 dB and a stopband attenuation of 20 dB. Display the phase delay response of the filter over the complete unit circle.

```
[b,a] = ellip(10,0.5,20,0.4);  
phasedelay(b,a,512,'whole')
```

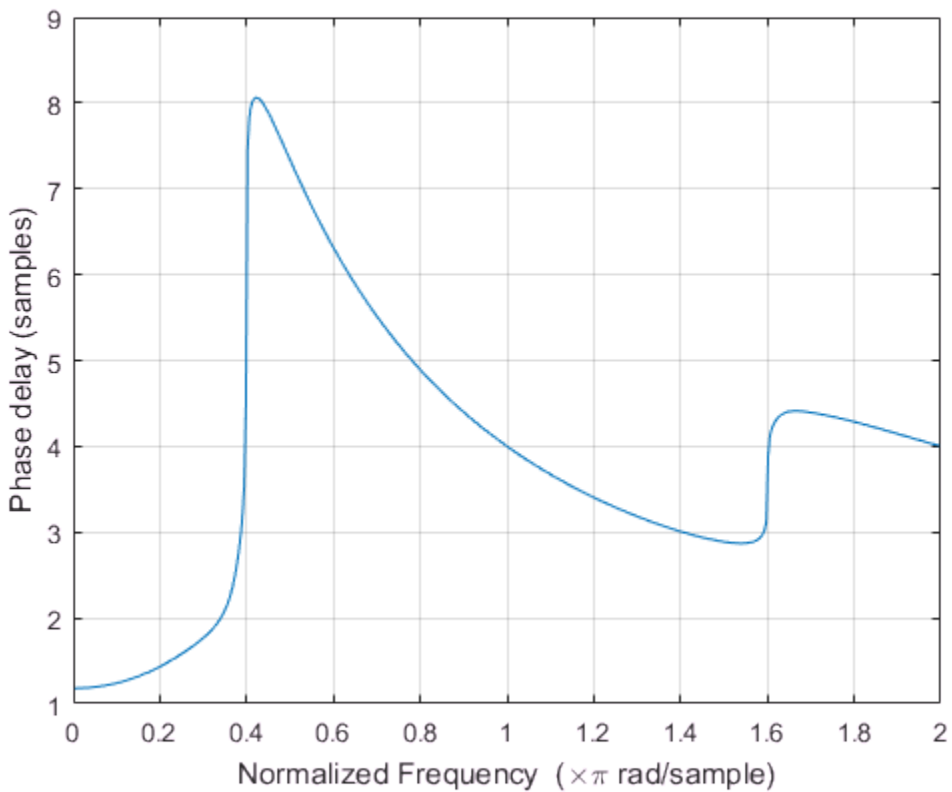

Repeat the example using `designfilt`.

```
d = designfilt('lowpassiir','DesignMethod','ellip','FilterOrder',10, ...  
              'PassbandFrequency',0.4, ...  
              'PassbandRipple',0.5,'StopbandAttenuation',20);  
phasedelay(d,512,'whole')
```

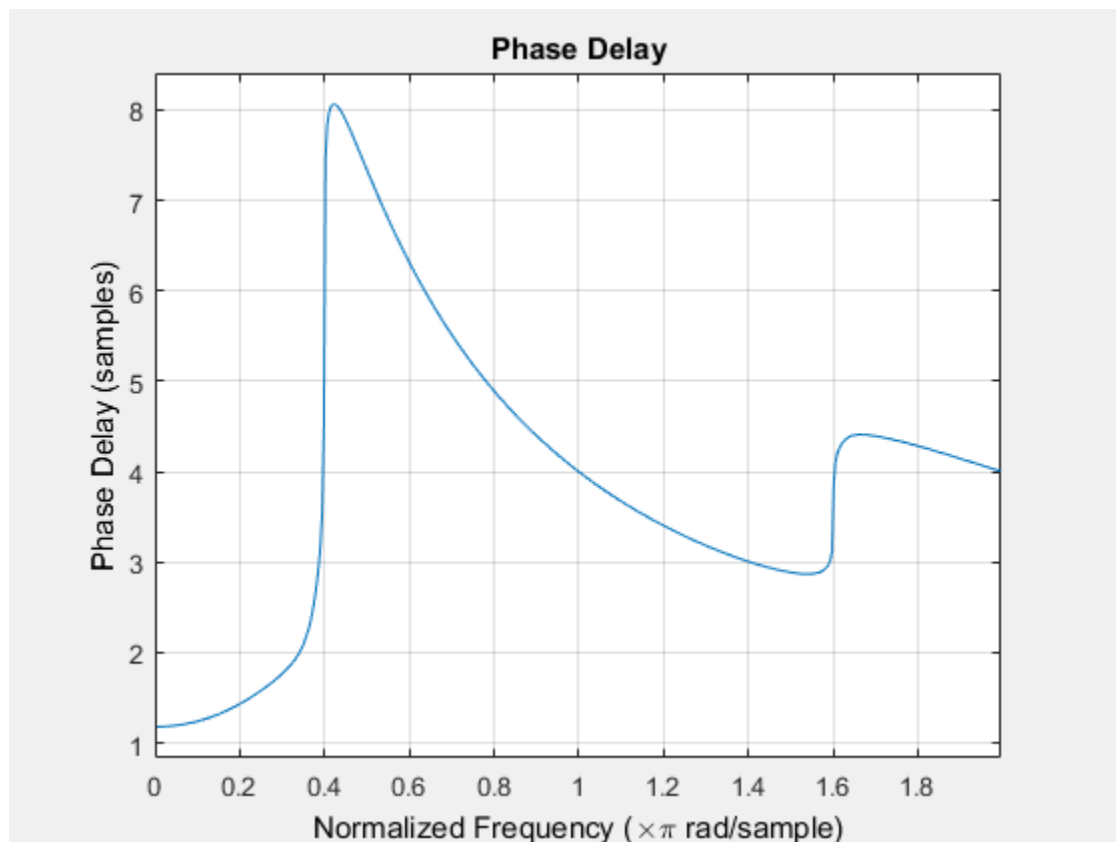

See Also

[designfilt](#) | [digitalFilter](#) | [freqz](#) | [fvtool](#) | [phasez](#) | [grpdelay](#)

Introduced before R2006a

phasez

Phase response of digital filter

Syntax

```
[phi,w] = phasez(b,a,n)
[phi,w] = phasez(sos,n)
[phi,w] = phasez(d,n)
[phi,w] = phasez(...,n,'whole')
phi = phasez(...,w)
[phi,f] = phasez(...,n,fs)
phi = phasez(...f,fs)
[phi,w,s] = phasez(...)
phasez(...)
```

Description

`[phi,w] = phasez(b,a,n)` returns the n -point unwrapped phase response vector, `phi`, in radians and the frequency vector, `w`, in radians/sample for the filter coefficients specified in `b` and `a`. The values of the frequency vector, `w`, range from 0 to π . If `n` is omitted, the length of the phase response vector defaults to 512. For best results, set `n` to a value greater than the filter order.

`[phi,w] = phasez(sos,n)` returns the unwrapped phase response for the second order sections matrix, `sos`. `sos` is a K -by-6 matrix, where the number of sections, K , must be greater than or equal to 2. If the number of sections is less than 2, `phasez` considers the input to be the numerator vector, `b`. Each row of `sos` corresponds to the coefficients of a second-order (biquad) filter. The i th row of the `sos` matrix corresponds to `[bi(1) bi(2) bi(3) ai(1) ai(2) ai(3)]`.

`[phi,w] = phasez(d,n)` returns the unwrapped phase response for the digital filter, `d`. Use `designfilt` to generate `d` based on frequency-response specifications.

`[phi,w] = phasez(...,n,'whole')` returns frequency and unwrapped phase response vectors evaluated at n equally-spaced points around the unit circle from 0 to 2π radians/sample.

`phi = phasez(...,w)` returns the unwrapped phase response in radians at frequencies specified in `w` (radians/sample). The frequencies are normally between 0 and π . The vector `w` must have at least two elements.

`[phi,f] = phasez(...,n,fs)` return the unwrapped phase vector `phi` in radians and the frequency vector in hertz. The frequency vector ranges from 0 to the Nyquist frequency, `fs/2`. If the 'whole' option is used, the frequency vector ranges from 0 to the sampling frequency.

`phi = phasez(...,f,fs)` return the phase response in radians at the frequencies specified in the vector `f` (in hertz) using the sampling frequency `fs` (in hertz). The vector `f` must have at least two elements.

`[phi,w,s] = phasez(...)` return plotting information, where `s` is a structure array with fields you can change to display different frequency response plots.

`phasez(...)` with no output arguments plots the phase response of the filter. If you input the filter coefficients or second order sections matrix, the current figure window is used. If you input a `digitalFilter`, the step response is displayed in `fvtool`.

Note: If the input to `phasez` is single precision, the phase response is calculated using single-precision arithmetic. The output, `phi`, is single precision.

Examples

Phase Response of an FIR Filter

Use `designfilt` to design an FIR filter of order 54, normalized cutoff frequency 0.3π rad/s, passband ripple 0.7 dB, and stopband attenuation 42 dB. Use the method of constrained least squares. Display the phase response of the filter.

```
Nf = 54;
Fc = 0.3;
Ap = 0.7;
As = 42;
```

```
d = designfilt('lowpassfir','CutoffFrequency',Fc,'FilterOrder',Nf, ...
               'PassbandRipple',Ap,'StopbandAttenuation',As, ...
```

```
phasez(d) 'DesignMethod','cls');
```

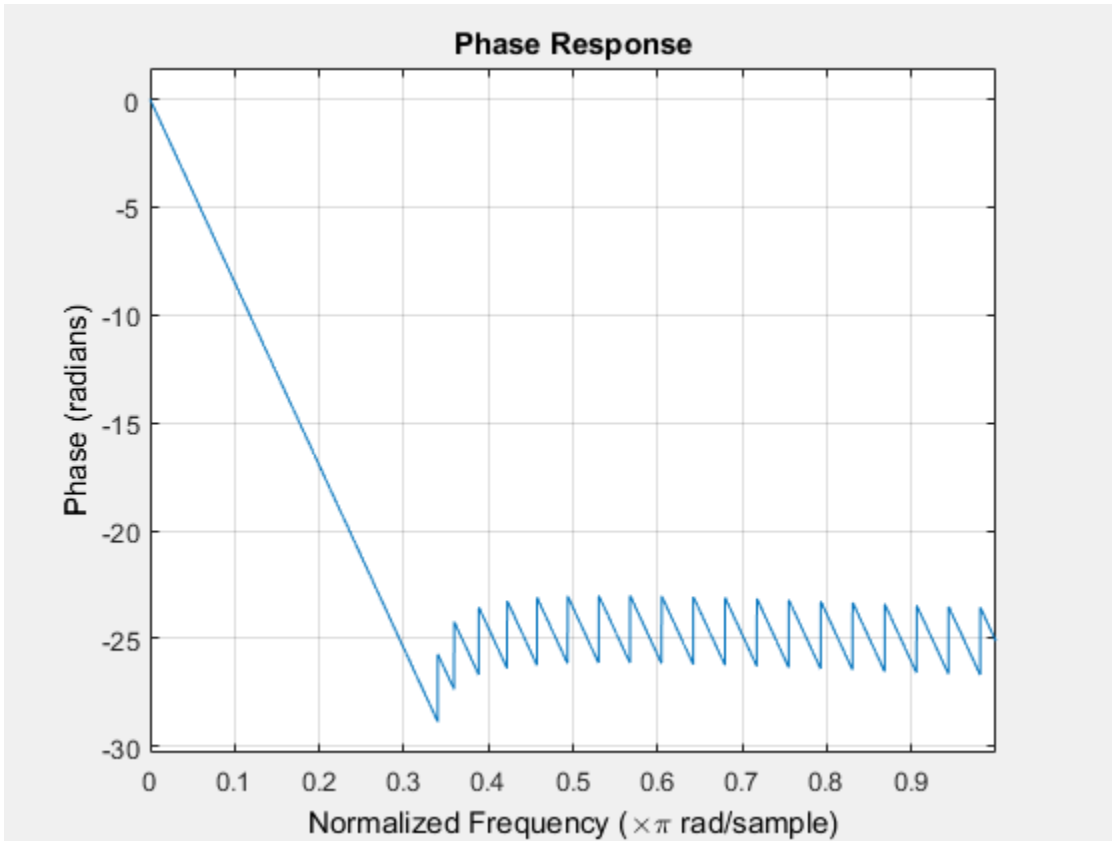

Design the same filter using `fircls1`. Keep in mind that `fircls1` uses linear units to measure the ripple and attenuation.

```
pAp = 10^(Ap/40);
Ap1 = (pAp-1)/(pAp+1);

pAs = 10^(As/20);
As1 = 1/pAs;

b = fircls1(Nf,Fc,Ap1,As1);
phasez(b)
```

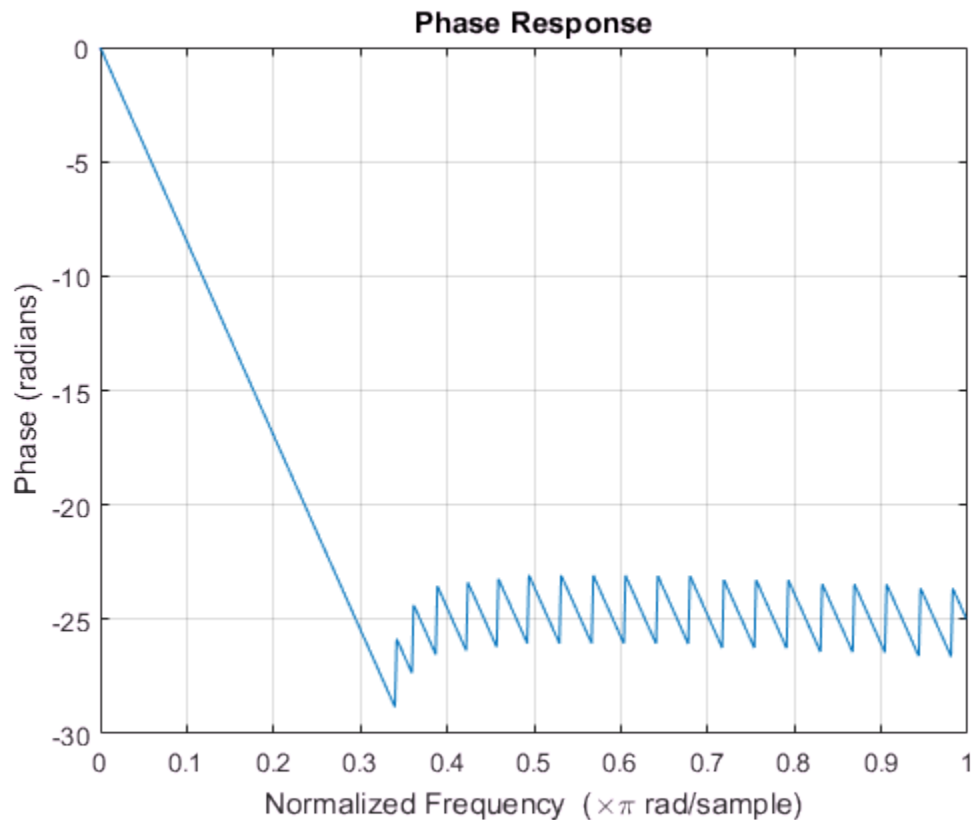
Phase Response of an Equiripple Filter

Design a lowpass equiripple filter with normalized passband frequency 0.45π rad/s, normalized stopband frequency 0.55π rad/s, passband ripple 1 dB, and stopband attenuation 60 dB. Display the phase response of the filter.

```
d = designfilt('lowpassfir', ...
              'PassbandFrequency',0.45,'StopbandFrequency',0.55, ...
              'PassbandRipple',1,'StopbandAttenuation',60, ...
              'DesignMethod','equiripple');
phasez(d)
```

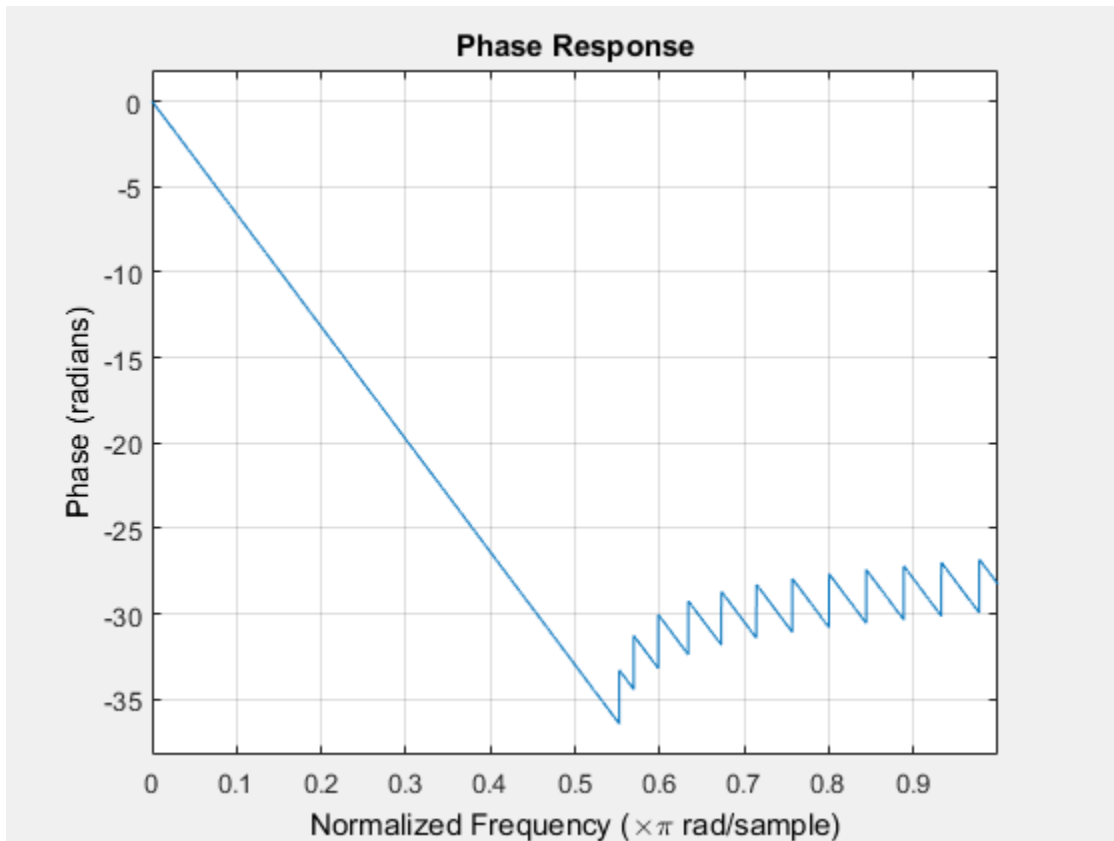

Phase Response of an Elliptic Filter

Design an elliptic lowpass IIR filter with normalized passband frequency 0.4π rad/s, normalized stopband frequency 0.5π rad/s, passband ripple 1 dB, and stopband attenuation 60 dB. Display the phase response of the filter.

```
d = designfilt('lowpassiir', ...
              'PassbandFrequency',0.4,'StopbandFrequency',0.5, ...
              'PassbandRipple',1,'StopbandAttenuation',60, ...
              'DesignMethod','ellip');
phasez(d)
```

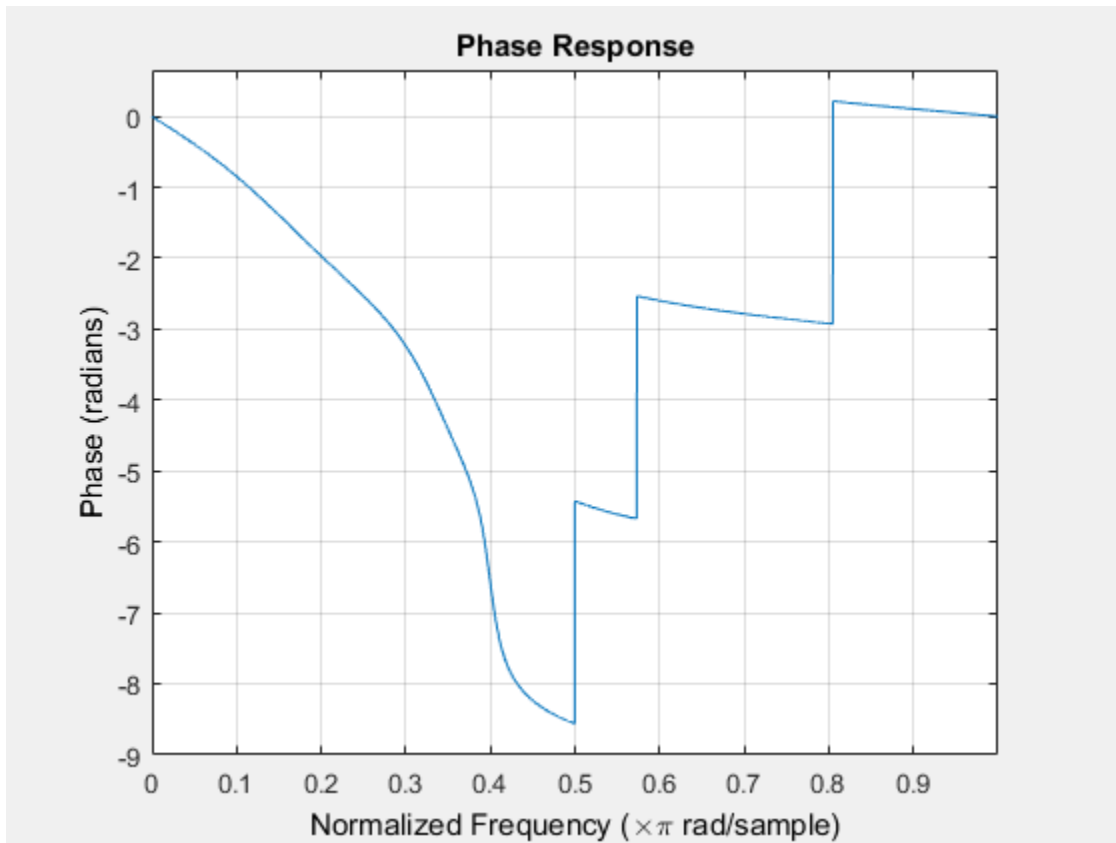

See Also

[designfilt](#) | [digitalFilter](#) | [freqz](#) | [fvtool](#) | [phasedelay](#) | [grpdelay](#)

Introduced before R2006a

plomb

Lomb-Scargle periodogram

Syntax

```
[pxx,f] = plomb(x,t)
[pxx,f] = plomb(x,fs)

[pxx,f] = plomb( ____,fmax)
[pxx,f] = plomb( ____,fmax,ofac)

[pxx,fvec] = plomb( ____,fvec)

[ ____ ] = plomb( ____,spectrumtype)

[ ____,pth] = plomb( ____, 'Pd',pdvec)

[pxx,w] = plomb(x)

plomb( ____ )
```

Description

`[pxx,f] = plomb(x,t)` returns the Lomb-Scargle power spectral density (PSD) estimate, `pxx`, of a signal, `x`, that is sampled at the instants specified in `t`. `t` must increase monotonically but need not be uniformly spaced. All elements of `t` must be nonnegative. `pxx` is evaluated at the frequencies returned in `f`.

- If `x` is a vector, it is treated as a single channel.
- If `x` is a matrix, then `plomb` computes the PSD independently for each column and returns it in the corresponding column of `pxx`.

`x` or `t` can contain NaNs or NaTs. These values are treated as missing data and excluded from the spectrum computation.

`[pxx,f] = plomb(x,fs)` treats the case where the signal is sampled uniformly, at a rate `fs`, but has missing samples. Specify the missing data using NaNs.

`[pxx, f] = plomb(____, fmax)` estimates the PSD up to a maximum frequency, `fmax`, using any of the input arguments from previous syntaxes. If the signal is sampled at N non-NaN instants, and Δt is the time difference between the first and the last of them, then `pxx` is returned at `round(fmax / fmin)` points, where $f_{\min} = 1/(4 \times N \times t_s)$ is the smallest frequency at which `pxx` is computed and the average sample time is $t_s = \Delta t / (N - 1)$. `fmax` defaults to $1/(2 \times t_s)$, which for uniformly sampled signals corresponds to the Nyquist frequency.

`[pxx, f] = plomb(____, fmax, ofac)` specifies an integer oversampling factor, `ofac`. The use of `ofac` to interpolate or smooth a spectrum resembles the zero-padding technique for FFT-based methods. `pxx` is again returned at `round(fmax/fmin)` frequency points, but the minimum frequency considered in this case is $1/(ofac \times N \times t_s)$. `ofac` defaults to 4.

`[pxx, fvec] = plomb(____, fvec)` estimates the PSD of `x` at the frequencies specified in `fvec`. `fvec` must have at least two elements. The second output argument is the same as the input `fvec`.

You cannot specify a maximum frequency or an oversampling factor if you use this syntax.

`[____] = plomb(____, spectrumtype)` specifies the normalization of the periodogram.

- Set `spectrumtype` to `'psd'`, or leave it unspecified, to obtain `pxx` as a power spectral density.
- Set `spectrumtype` to `'power'` to get the power spectrum of the input signal.
- Set `spectrumtype` to `'normalized'` to get the standard Lomb-Scargle periodogram, which is scaled by two times the variance of `x`.

`[____, pth] = plomb(____, 'Pd', pdvec)` returns the power-level threshold, `pth`, such that a peak with a value larger than `pth` has a probability `pdvec` of being a true signal peak and not the result of random fluctuations. `pdvec` can be a vector. Every element of `pdvec` must be greater than 0 and smaller than 1. Each row of `pth` corresponds to an element of `pdvec`. `pth` has the same number of channels as `x`. This option is not available if you specify the output frequencies in `fvec`.

`[pxx, w] = plomb(x)` returns the PSD estimate of `x` evaluated at a set of evenly spaced normalized frequencies, `w`, spanning the Nyquist interval. Use NaNs to specify missing

samples. All of the above options are available for normalized frequencies. To access them, specify an empty array as the second input.

`plomb(___)` with no output arguments plots the Lomb-Scargle periodogram PSD estimate in the current figure window.

Examples

Irregularly Sampled Signal and Signal with Missing Samples

The Lomb-Scargle method can handle signals that have been sampled unevenly or have missing samples.

Generate a two-channel sinusoidal signal sampled at 1 kHz for about 0.5 s. The sinusoid frequencies are 175 Hz and 400 Hz. Embed the signal in white noise with variance

$$\sigma^2 = 1/4.$$

```
Fs = 1000;  
f0 = 175;  
f1 = 400;
```

```
t = 0:1/Fs:0.5;
```

```
wgn = randn(length(t),2)/2;
```

```
sigOrig = sin(2*pi*[f0;f1]*t)' + wgn;
```

Compute and plot the periodogram of the signal. Use `periodogram` with the default settings.

```
periodogram(sigOrig,[],[],Fs)
```

```
axisLim = axis;  
title('Periodogram')
```

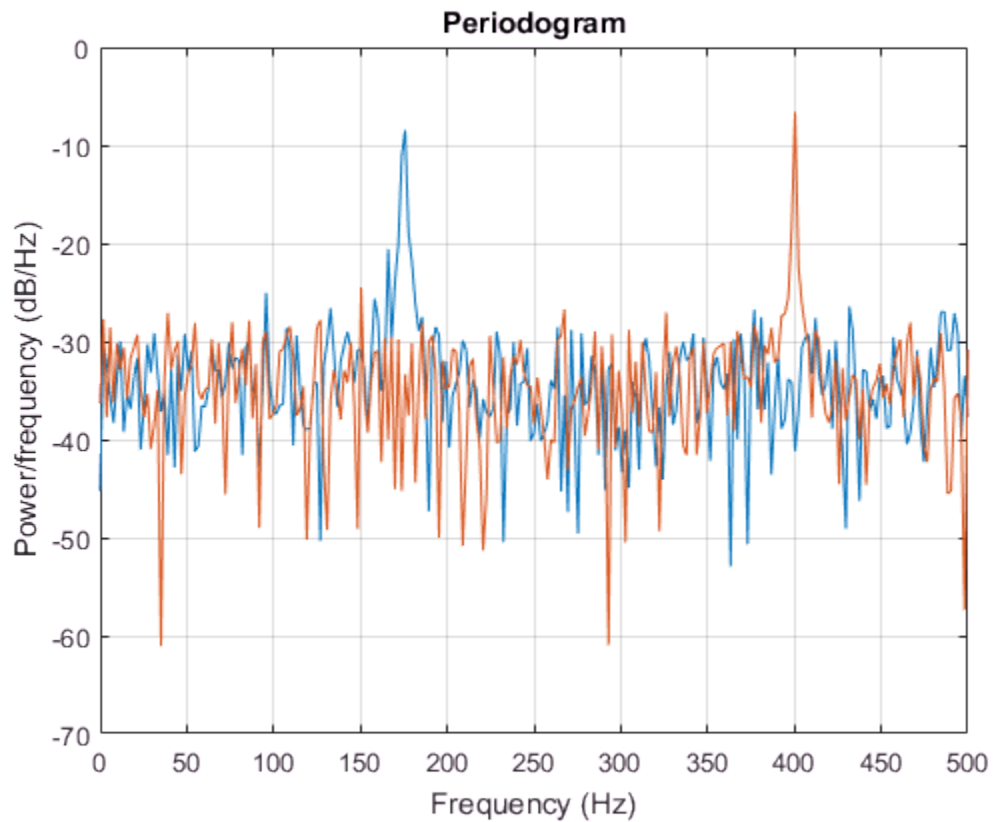

Use `plomb` with the default settings to estimate and plot the PSD of the signal. Use the axis limits from the previous plot.

```
plomb(sigOrig,t)

axis(axisLim)
title('Lomb-Scargle')
```

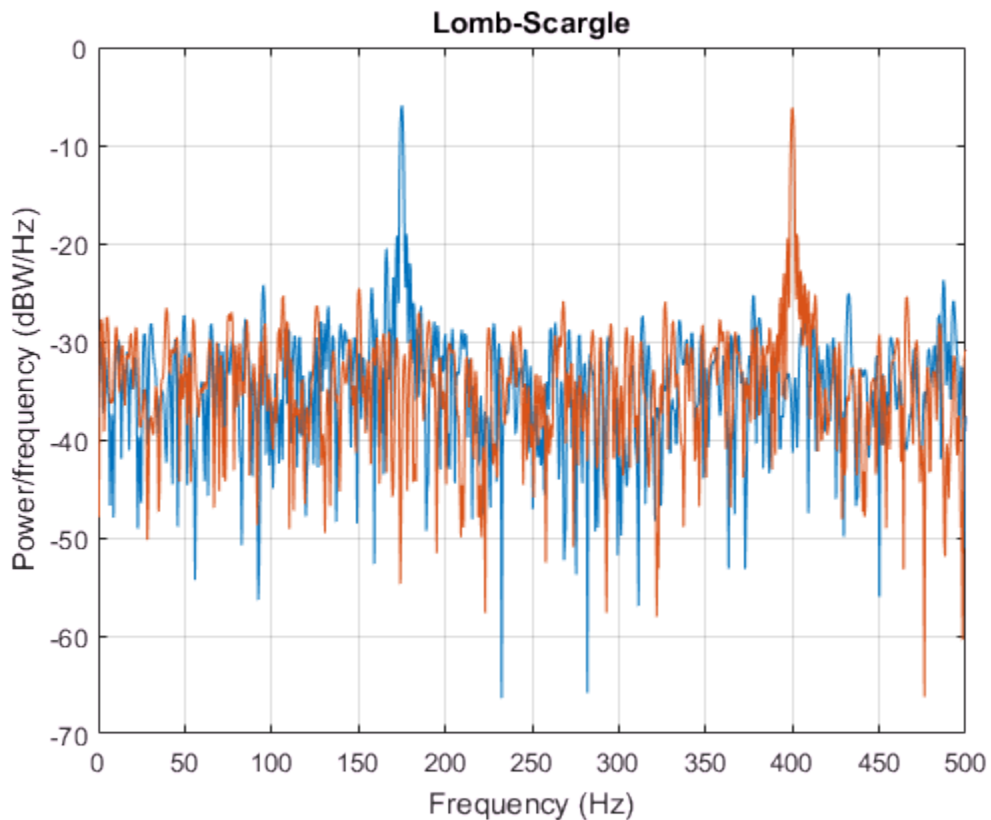

Suppose the signal is missing 10% of the original samples. Place NaN's in random locations to simulate the missing data points. Use `plomb` to estimate and plot the PSD of the signal with missing samples.

```
sinMiss = sigOrig;  
  
misfrac = 0.1;  
nTime = length(t)*2;  
  
sinMiss(randperm(nTime,round(nTime*misfrac))) = NaN;  
  
plomb(sinMiss,t)  
  
axis(axisLim)
```



```
title('Missing Samples')
```

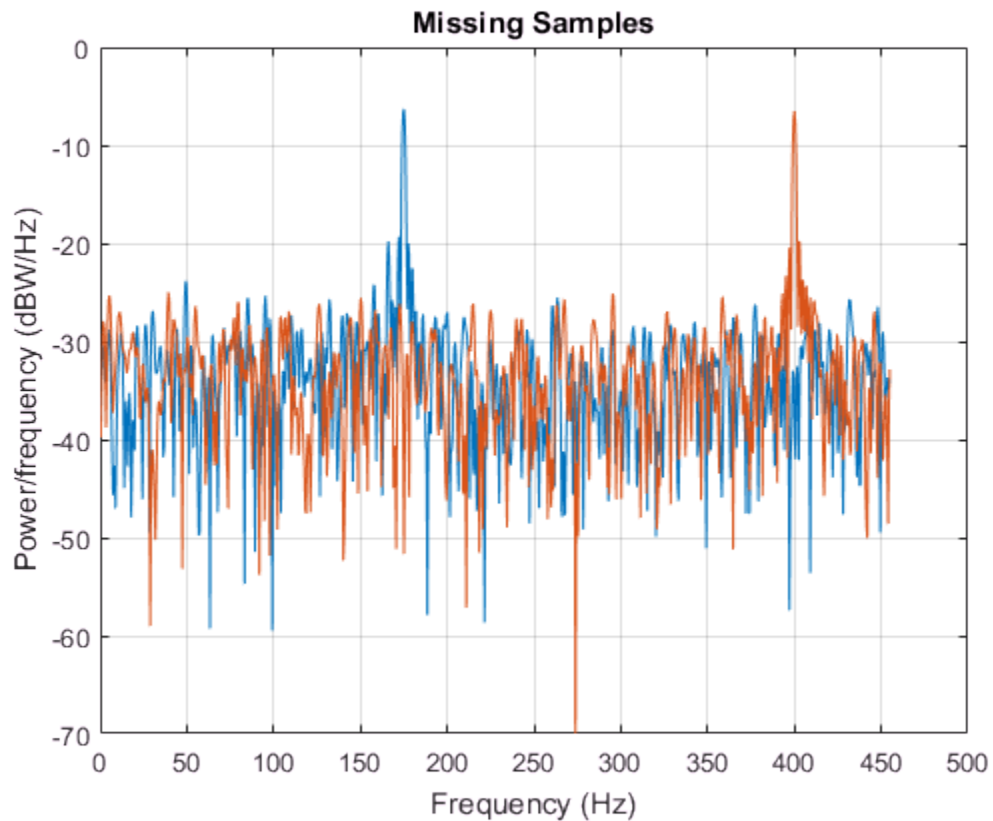

Sample the original signal, but make the sampling nonuniform by adding jitter (uncertainty) to the time measurements. The first instant continues to be at zero. Use `plomb` to estimate and plot the PSD of the nonuniformly sampled signal.

```
tirr = t + (1/2-rand(size(t)))/Fs/2;
tirr(1) = 0;

sinIrreg = sin(2*pi*[f0;f1]*tirr)' + wgn;

plomb(sinIrreg,tirr)

axis(axisLim)
```

```
title('Nonuniform Sampling')
```

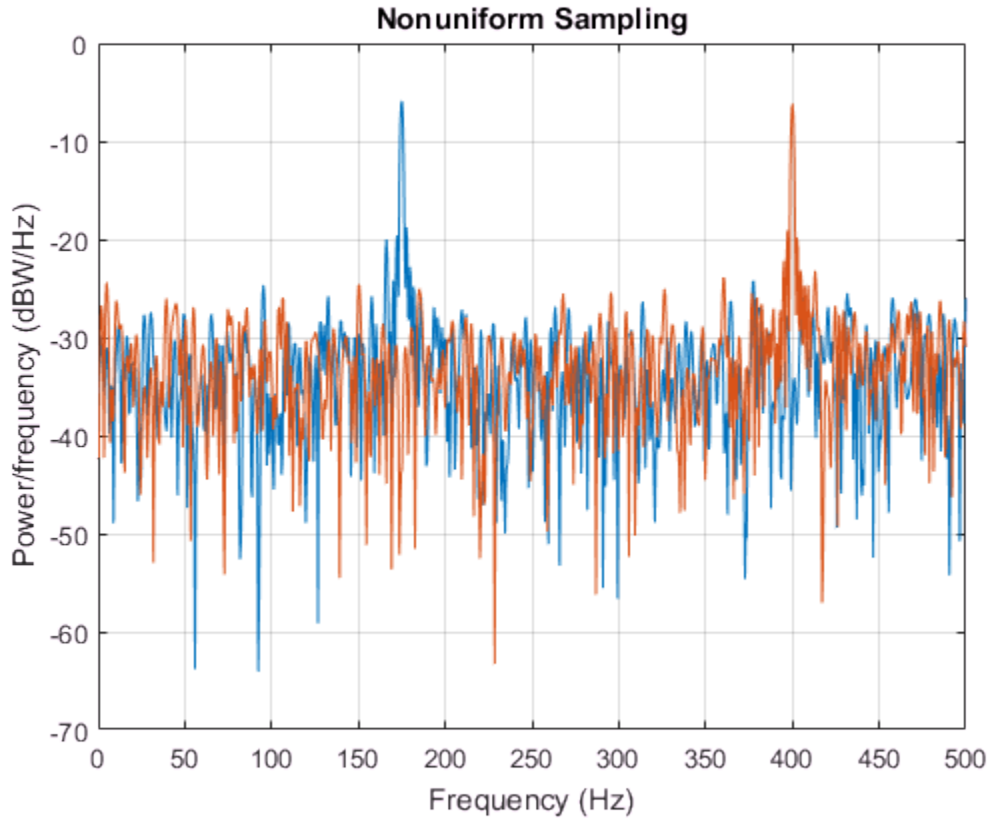

Periodogram of Data Set with Missing Samples

Galileo Galilei observed the motion of Jupiter's four largest satellites during the winter of 1610. When the weather allowed, Galileo recorded the satellites' locations. Use his observations to estimate the orbital period of one of the satellites, Callisto.

Callisto's angular position is measured in minutes of arc. Missing data due to cloudy conditions are specified using NaNs. The first observation is dated January 15. Generate a `datetime` array of observation times.

```
yg = [10.5 NaN 11.5 10.5 NaN NaN NaN -5.5 -10.0 -12.0 -11.5 -12.0 -7.5 ...  
      NaN NaN NaN NaN 8.5 12.5 12.5 10.5 NaN NaN NaN -6.0 -11.5 -12.5 ...  
      -12.5 -10.5 -6.5 NaN 2.0 8.5 10.5 NaN 13.5 NaN 10.5 NaN NaN NaN ...  
      -8.5 -10.5 -10.5 -10.0 -8.0]';
```

```
obsv = datetime(1610,1,14+(1:length(yg)));
```

```
plot(yg, 'o')
```

```
ax = gca;  
nights = [1 18 32 46];  
ax.XTick = nights;  
ax.XTickLabel = char(obsv(nights));  
grid
```

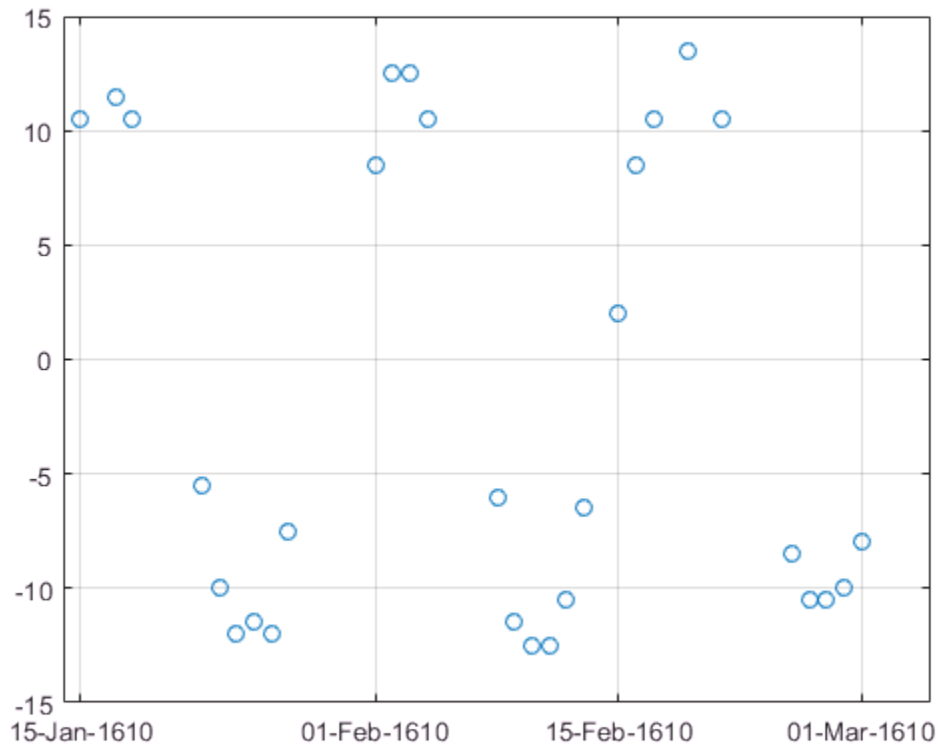

Estimate the power spectrum of the data using `plomb`. Specify an oversampling factor of 10. Express the resulting frequencies in inverse days.

```
[pxx,f] = plomb(yg,obsv,[],10,'power');  
f = f*86400;
```

Use `findpeaks` to determine the location of the only prominent peak of the spectrum. Plot the power spectrum and show the peak.

```
[pk,f0] = findpeaks(pxx,f,'MinPeakHeight',10);  
  
plot(f,pxx,f0,pk,'o')  
xlabel('Frequency (day-1)')  
title('Power Spectrum and Prominent Peak')  
grid
```

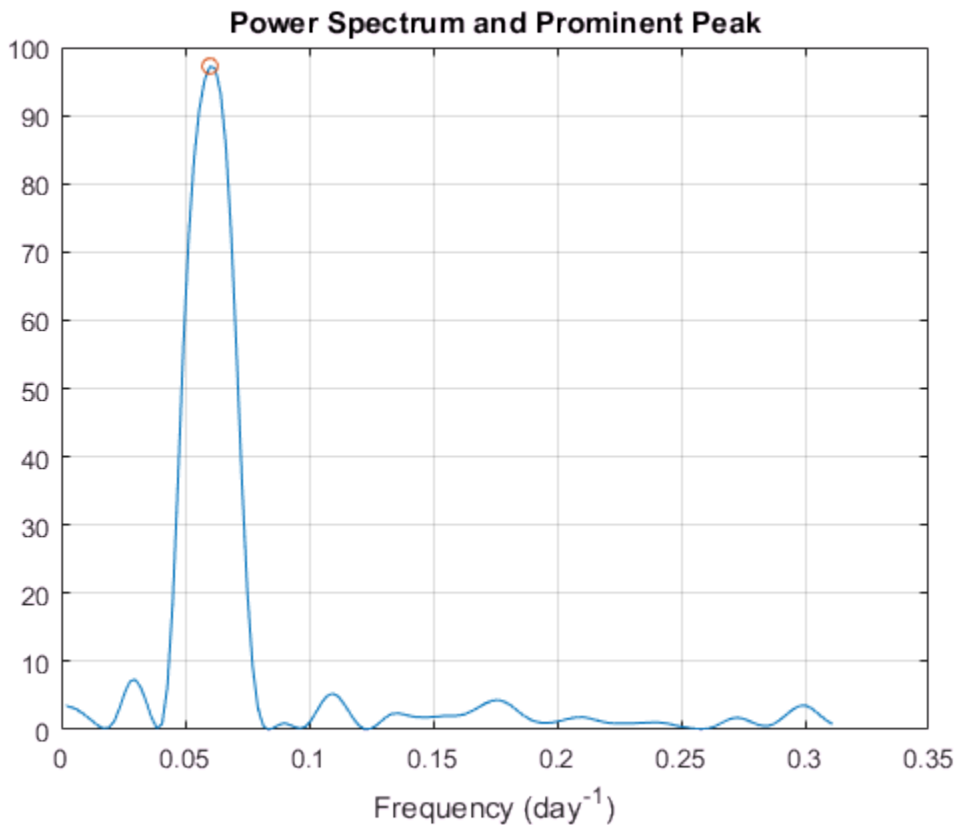

Determine Callisto's orbital period (in days) as the inverse of the frequency of maximum energy. The result differs by less than 1% from the value published by NASA.

```
Period = 1/f0
```

```
Period = 16.6454
```

```
NASA = 16.6890184;
```

```
PercentDiscrep = (Period-NASA)/NASA*100
```

```
PercentDiscrep = -0.2613
```

Periodogram of Data Set with Irregular Sampling

Galileo Galilei discovered Jupiter's four largest satellites in January of 1610 and recorded their locations every clear night until March of that year. Use Galileo's data to find the orbital period of Callisto, the outermost of the four satellites.

Galileo's observations of Callisto's angular position are in minutes of arc. There are several gaps due to cloudy conditions. Generate a `duration` array of observation times.

```
t = [0 2 3 7 8 9 10 11 12 17 18 19 20 24 25 26 27 28 29 31 32 33 35 37 ...
     41 42 43 44 45]';
```

```
td = days(t);
```

```
yg = [10.5 11.5 10.5 -5.5 -10.0 -12.0 -11.5 -12.0 -7.5 8.5 12.5 12.5 ...
     10.5 -6.0 -11.5 -12.5 -12.5 -10.5 -6.5 2.0 8.5 10.5 13.5 10.5 -8.5 ...
     -10.5 -10.5 -10.0 -8.0]';
```

```
plot(td,yg, 'o')
```

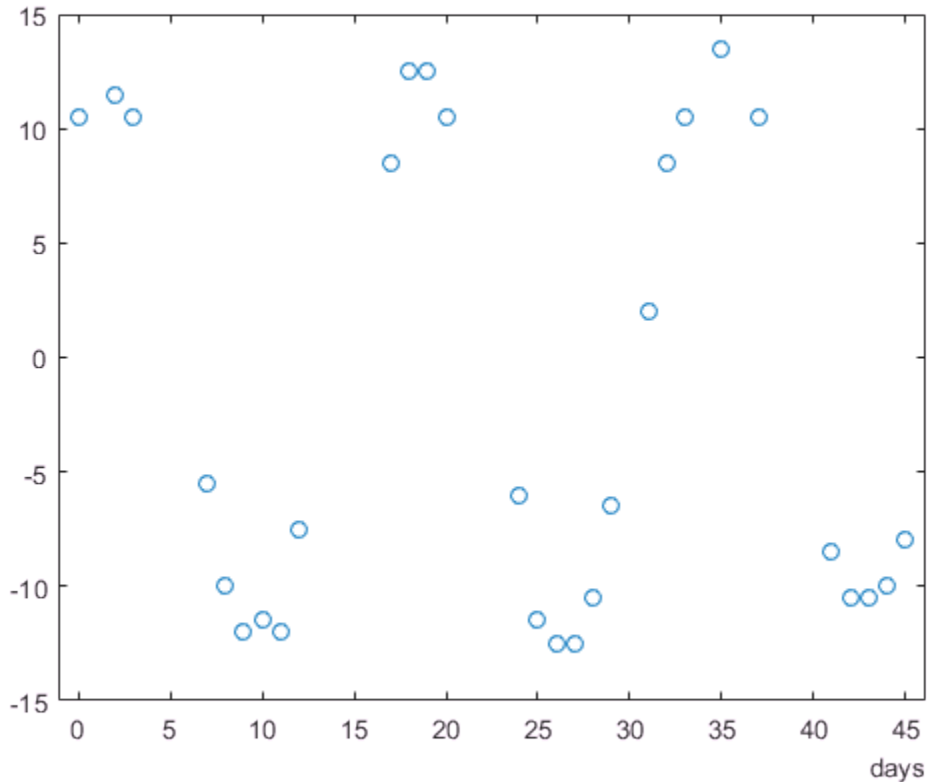

Use `plomb` to compute the periodogram of the data. Estimate the power spectrum up to a frequency of 0.5 day^{-1} . Specify an oversampling factor of 10. Choose the standard Lomb-Scargle normalization.

```
oneday = seconds(days(1));
[pxx,f] = plomb(yg,td,0.5/oneday,10,'normalized');
f = f*oneday;
```

The periodogram has one clear maximum. Name the peak frequency f_0 . Plot the periodogram and annotate the peak.

```
[pmax,lmax] = max(pxx);
f0 = f(lmax);

plot(f,pxx,f0,pmax,'o')
xlabel('Frequency (day-1)')
```

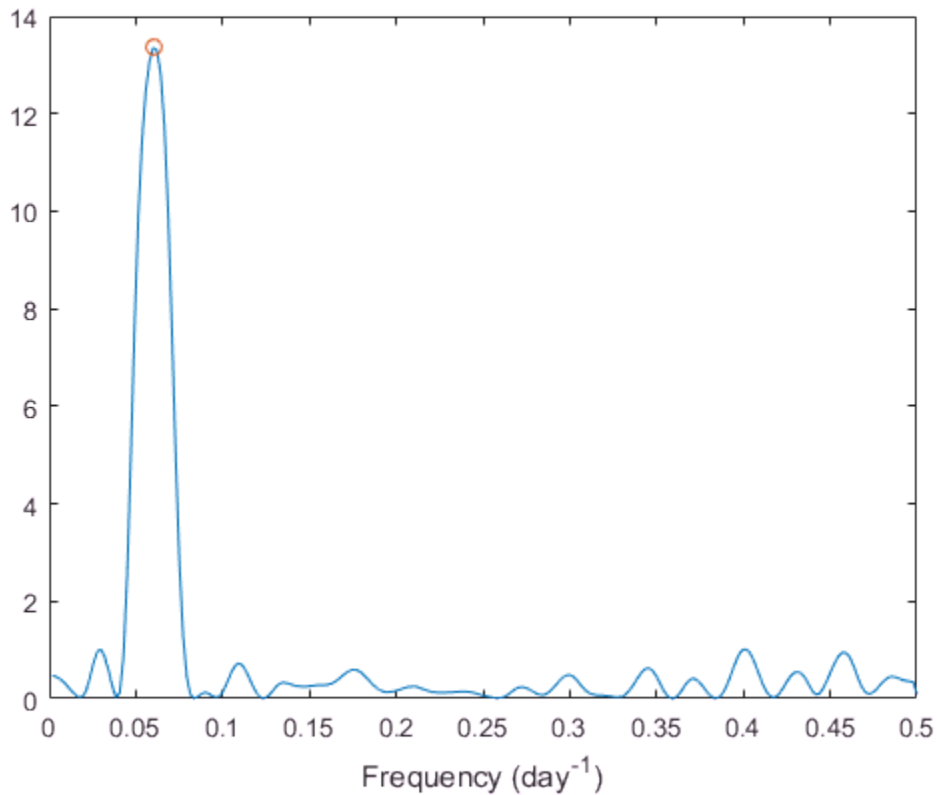

Use linear least squares to fit to the data a function of the form

$$y(t) = A + B \cos 2\pi f_0 t + C \sin 2\pi f_0 t.$$

The fitting parameters are the amplitudes A , B , and C .

```
ft = 2*pi*f0*t;
```

```
ABC = [ones(size(ft)) cos(ft) sin(ft)] \ yg
```

```
ABC =
```

```
    0.4243  
   10.4444  
    6.6137
```

Use the fitting parameters to construct the fitting function on a 200-point interval. Plot the data and overlay the fit.

```
x = linspace(t(1),t(end),200)';  
fx = 2*pi*f0*x;  
  
y = [ones(size(fx)) cos(fx) sin(fx)] * ABC;  
  
plot(td,yg,'o',days(x),y)
```

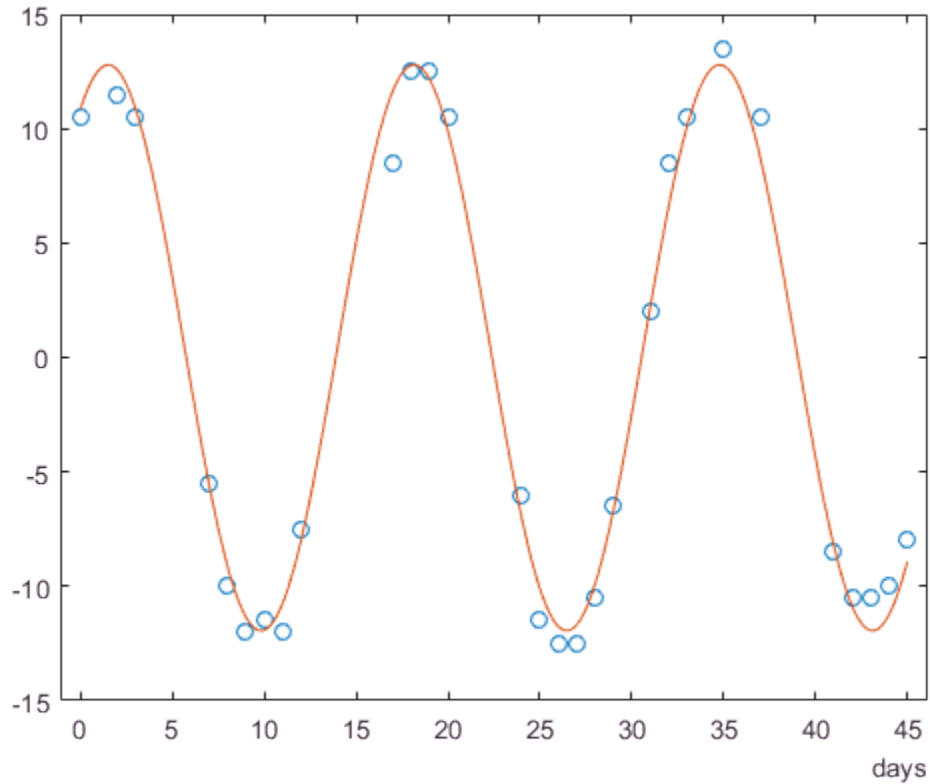
Irregular Sampling and Aliasing

Sample a 0.8 Hz sinusoid at 1 Hz for 100 s. Embed the sinusoid in white noise with a variance of 1/100. Reset the random number generator for repeatable results.

```
f0 = 0.8;
```

```
rng default
```

```
wgn = randn(1,100)/10;
```

```
ts = 1:100;
```

```
s = sin(2*pi*f0*ts) + wgn;
```

Compute and plot the power spectral density estimate up to the sample rate. Specify an oversampling factor of 10.

```
plomb(s,ts,1,10)
```

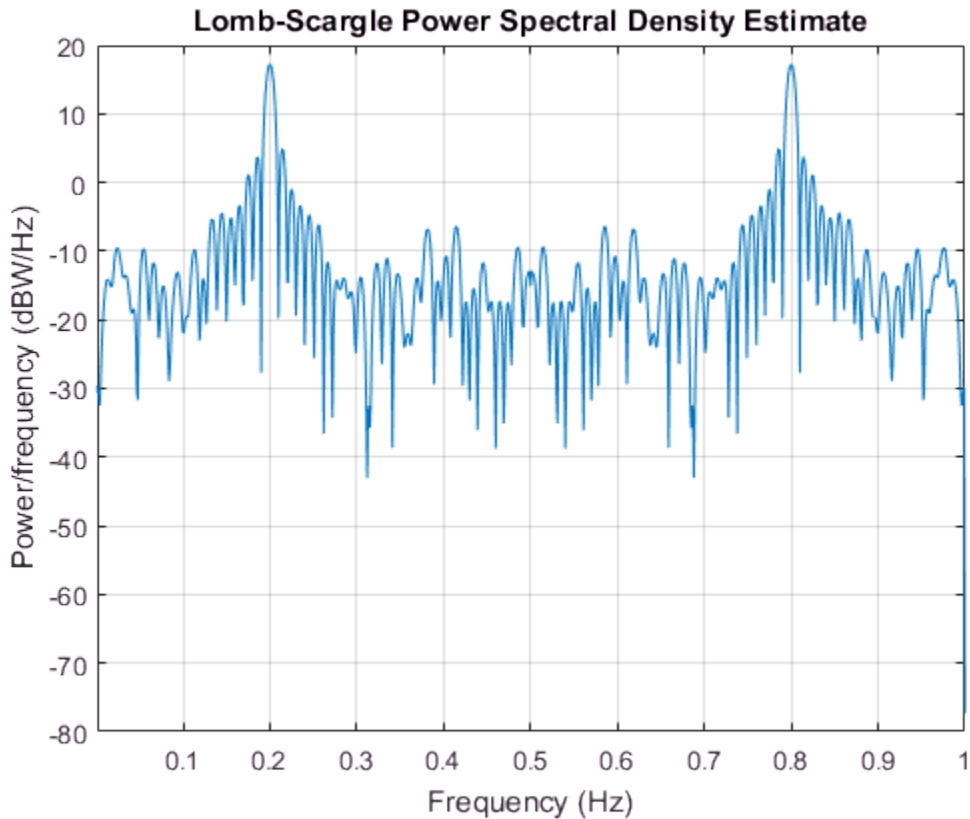

There is aliasing because the frequency of the sinusoid is greater than the Nyquist frequency.

Repeat the calculation, but now sample the sinusoid at random times. Include frequencies up to 1 Hz. Specify an oversampling factor of 2. Plot the PSD.

```
tn = sort(100*rand(1,100));
n = sin(2*pi*f0*tn) + wgn;
```

```
ofac = 2;  
plomb(n,tn,1,ofac)
```

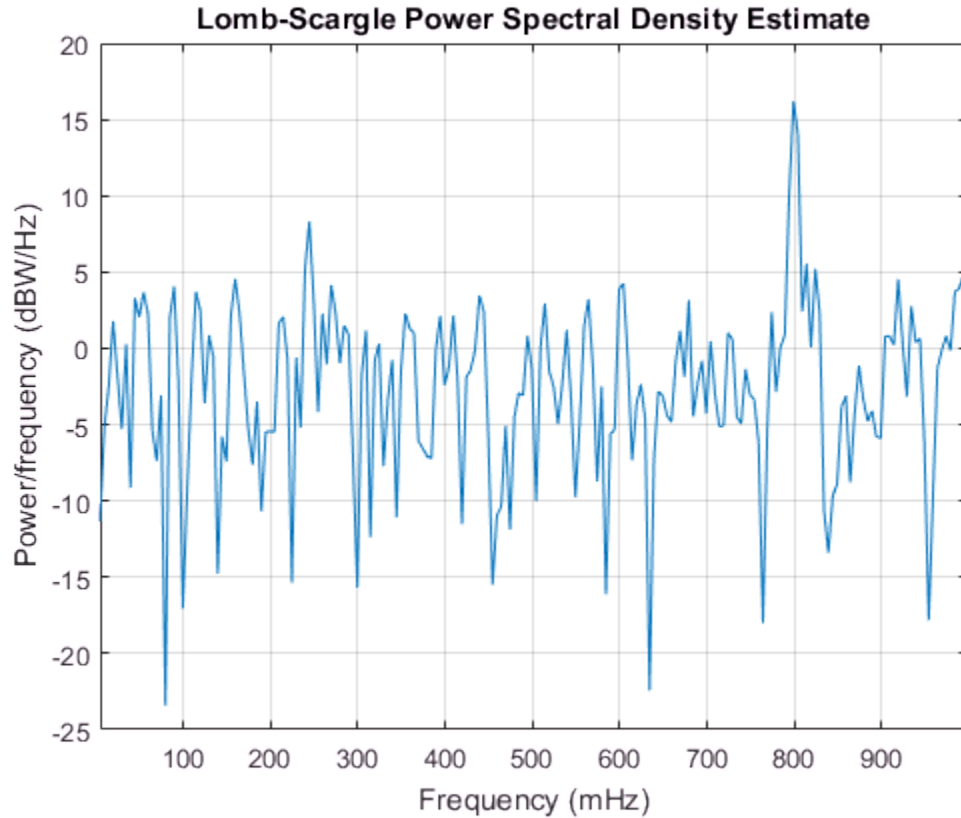

The aliasing disappears. The irregular sampling increases the effective sample rate by shrinking some time intervals.

Zoom in on the frequencies around 0.8 Hz. Use a fine grid with a spacing of 0.001 Hz. You cannot specify an oversampling factor or a maximum frequency in this case.

```
df = 0.001;  
fvec = 0.7:df:0.9;
```

```
hold on
plomb(n,tn,fvec)
legend('ofac = 2','df = 0.001')
```

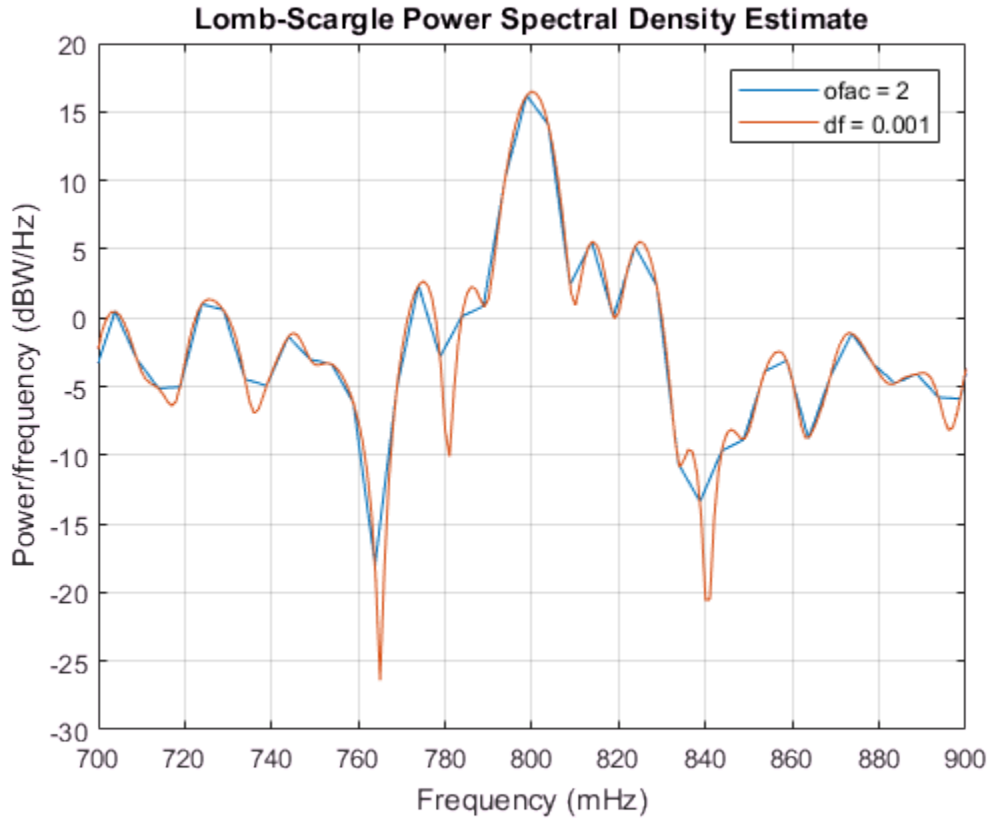

Exponential Distribution

Generate $N = 1024$ samples of white noise with variance $\sigma = 1$, given a sample rate of 1 Hz. Compute the power spectrum of the white noise. Choose the Lomb-Scargle

normalization and specify an oversampling factor $ofac = 15$. Reset the random number generator for repeatable results.

```

rng default

N = 1024;
t = (1:N)';
wgn = randn(N,1);

ofac = 15;
[pwgn,f] = plomb(wgn,t,[],ofac,'normalized');

```

Verify that the Lomb-Scargle power spectrum estimate of white noise has an exponential distribution with unit mean. Plot a histogram of the values of `pwgn` and a histogram of a set of exponentially distributed random numbers generated using the distribution function $f(z|1) = e^{-z}$. To normalize the histograms, recall that the total number of periodogram samples is $N \times \text{ofac}/2$. Specify a bin width of 0.25. Overlay a plot of the theoretical distribution function.

```

dx = 0.25;
br = 0:dx:5;

Nf = N*ofac/2;

hpwgn = histcounts(pwgn,br)';
hRand = histcounts(-log(rand(Nf,1)),br)';

bend = br(1:end-1);

bar(bend,[hpwgn hRand]/Nf/dx,'histc')
hold on
plot(br,exp(-br))
legend('wgn','Empirical pdf','Theoretical pdf')
hold off

```

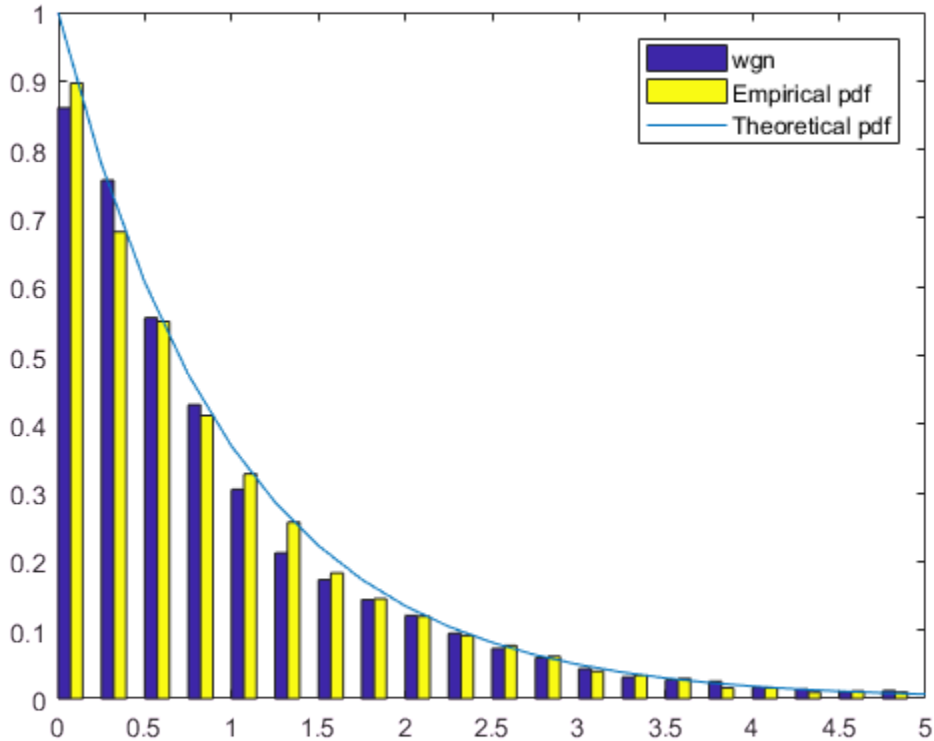

Embed in the noise a sinusoidal signal of frequency 0.1 Hz. Use a signal-to-noise ratio of $\xi = 0.01$. Specify the sinusoid amplitude, x_0 , using the relation $x_0 = \sigma \sqrt{2\xi}$. Compute the power spectrum of the signal and plot its histogram alongside the empirical and theoretical distribution functions.

```
SNR = 0.01;
x0 = sqrt(2*SNR);
sigsmall = wgn + x0*sin(2*pi/10*t);

[psigsmall,f] = plomb(sigsmall,t,[],ofac,'normalized');

hpsigsmall = histcounts(psigsmall,br)';
```

```

bar(bend,[hpsigsmall hRand]/Nf/dx,'histc')
hold on
plot(br,exp(-br))
legend('sigsmall','Empirical pdf','Theoretical pdf')
hold off

```

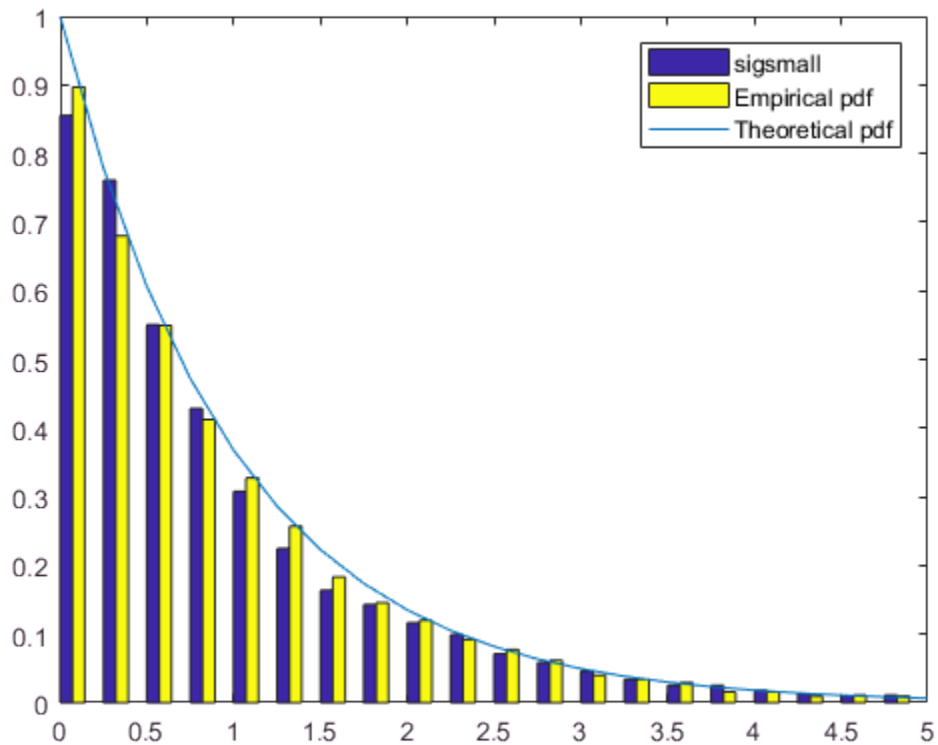

Repeat the calculation using $\xi = 1$. The distribution now differs noticeably.

```

SNR = 1;
x0 = sqrt(2*SNR);
siglarge = wgn + x0*sin(2*pi/10*t);

[psiglarge,f] = plomb(siglarge,t,[],ofac,'normalized');

```

```

hpsiglarge = histcounts(psiglarge,br)';

bar(bend,[hpsiglarge hRand]/Nf/dx,'histc')
hold on
plot(br,exp(-br))
legend('siglarge','Empirical pdf','Theoretical pdf')
hold off

```

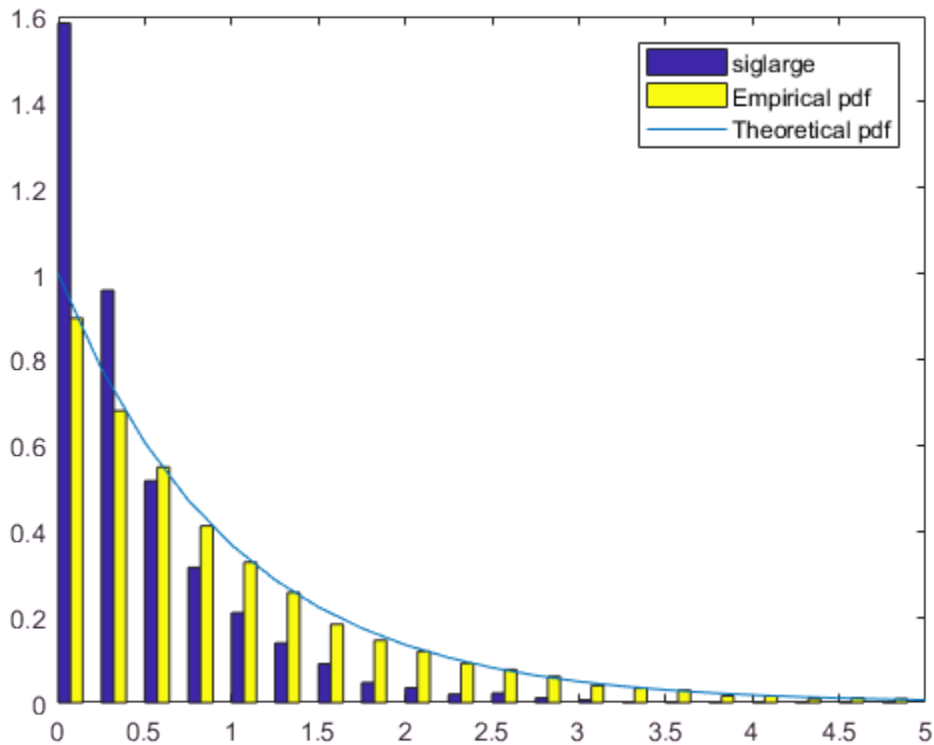

False-Alarm Probabilities

Generate 100 samples of a sinusoidal signal at a sample rate of 1 Hz. Specify an amplitude of 0.75 and a frequency of $0.6/2\pi \approx 0.096$ Hz. Embed the signal in white noise of variance 0.902. Reset the random number generator for repeatable results.

```
rng default
```

```
X0 = 0.75;  
f0 = 0.6;  
vr = 0.902;
```

```
Nsamp = 100;  
t = 1:Nsamp;  
X = X0*cos(f0*(1:Nsamp))+randn(1,Nsamp)*sqrt(vr);
```

Discard 10% of the samples at random. Plot the signal.

```
X(randperm(Nsamp,Nsamp/10)) = NaN;
```

```
plot(t,X,'o')
```

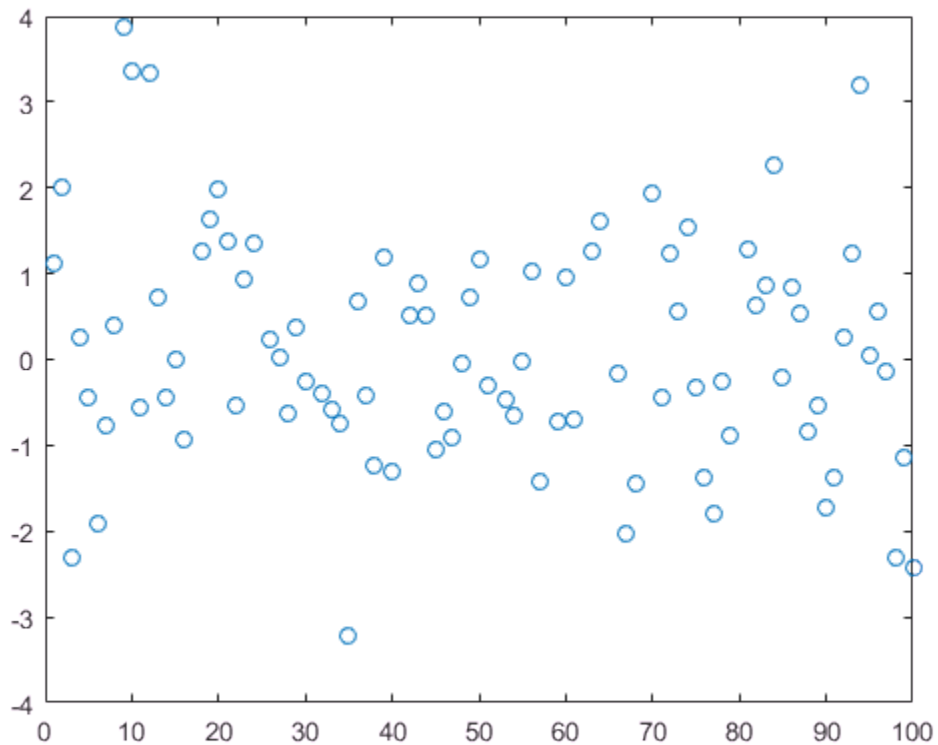

Compute and plot the normalized power spectrum. Annotate the levels that correspond to false-alarm probabilities of 50%, 10%, 1%, and 0.01%. If you generate many 90-sample white noise signals with variance 0.902, then half of them have one or more peaks higher than the 50% line, 10% have one or more peaks higher than the 10% line, and so on.

```
Pfa = [50 10 1 0.01]/100;
Pd = 1-Pfa;

[pxx,f,pth] = plomb(X,1:Nsamp,'normalized','Pd',Pd);

plot(f,pxx,f,pth*ones(size(f')))
xlabel('f')
text(0.3*[1 1 1 1],pth-.5,[repmat('P_{fa} = ',[4 1]) num2str(Pfa')])
```

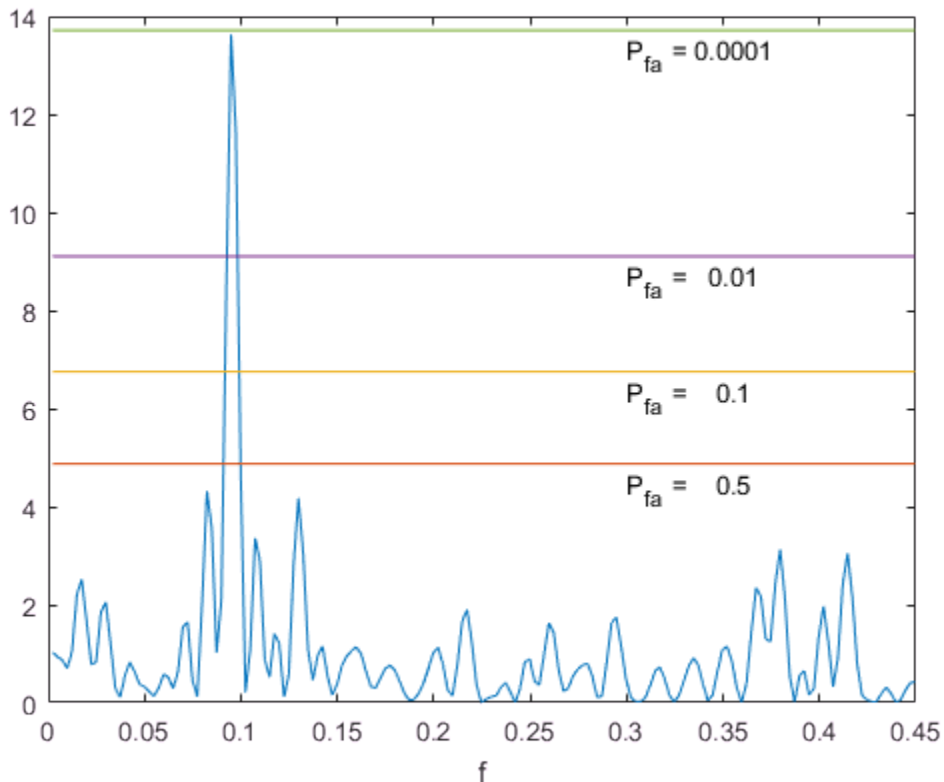

In this case, the peak is high enough that only about 0.01% of the possible signals can attain it.

Use `plomb` with no output arguments to repeat the calculation. The plot is now logarithmic, and the levels are drawn in terms of detection probabilities.

```
plomb(X,1:Nsamp,'normalized','Pd',Pd)
```

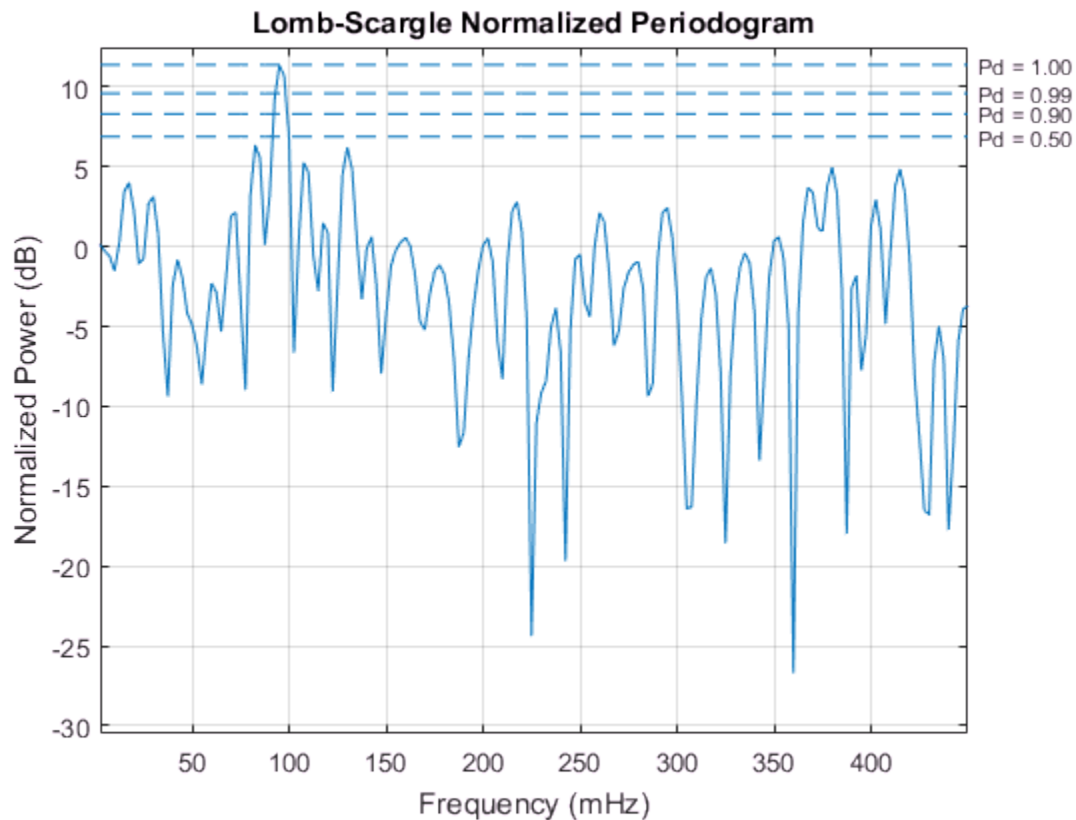

Lomb-Scargle Periodogram of Noisy Sinusoids

When given a data vector as the only input, `plomb` estimates the power spectral density using normalized frequencies.

Generate 128 samples of a sinusoid of normalized frequency $\pi/2$ rad/sample embedded in white Gaussian noise of variance 1/100.

```
t = (0:127)';  
x = sin(2*pi*t/4);  
x = x + randn(size(x))/10;
```

Estimate the PSD using the Lomb-Scargle procedure. Repeat the calculation with periodogram.

```
[p,f] = plomb(x);  
[pper,fper] = periodogram(x);
```

Plot the PSD estimates in decibels. Verify that the results are equivalent.

```
plot(f/pi,pow2db(p))  
hold on  
plot(fper/pi,pow2db(pper))  
  
axis([0 1 -40 20])  
xlabel('\omega / \pi')  
ylabel('PSD')  
legend('plomb','periodogram')
```

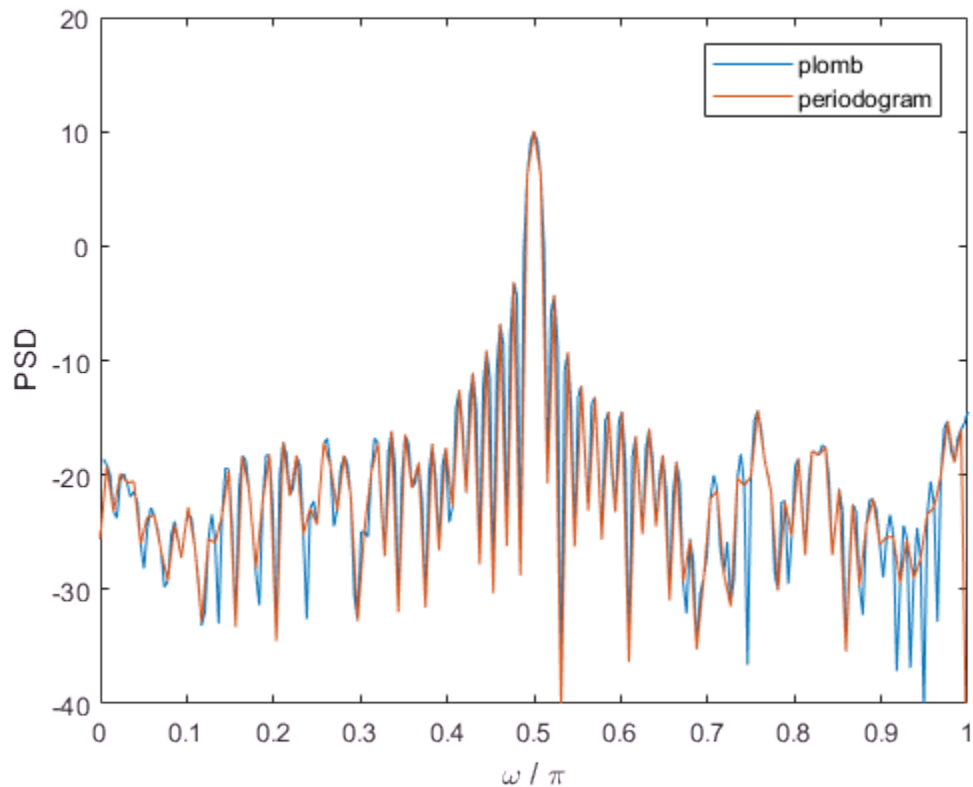

Estimate the Lomb-Scargle PSD of a three-channel signal composed of sinusoids. Specify the frequencies as $2\pi/3$ rad/sample, $\pi/2$ rad/sample, and $2\pi/5$ rad/sample. Add white Gaussian noise of variance 1/100. Use `plomb` with no output arguments to compute and plot the PSD estimate in decibels.

```
x3 = [sin(2*pi*t/3) sin(2*pi*t/4) sin(2*pi*t/5)];
x3 = x3 + randn(size(x3))/10;
```

```
figure
plomb(x3)
```

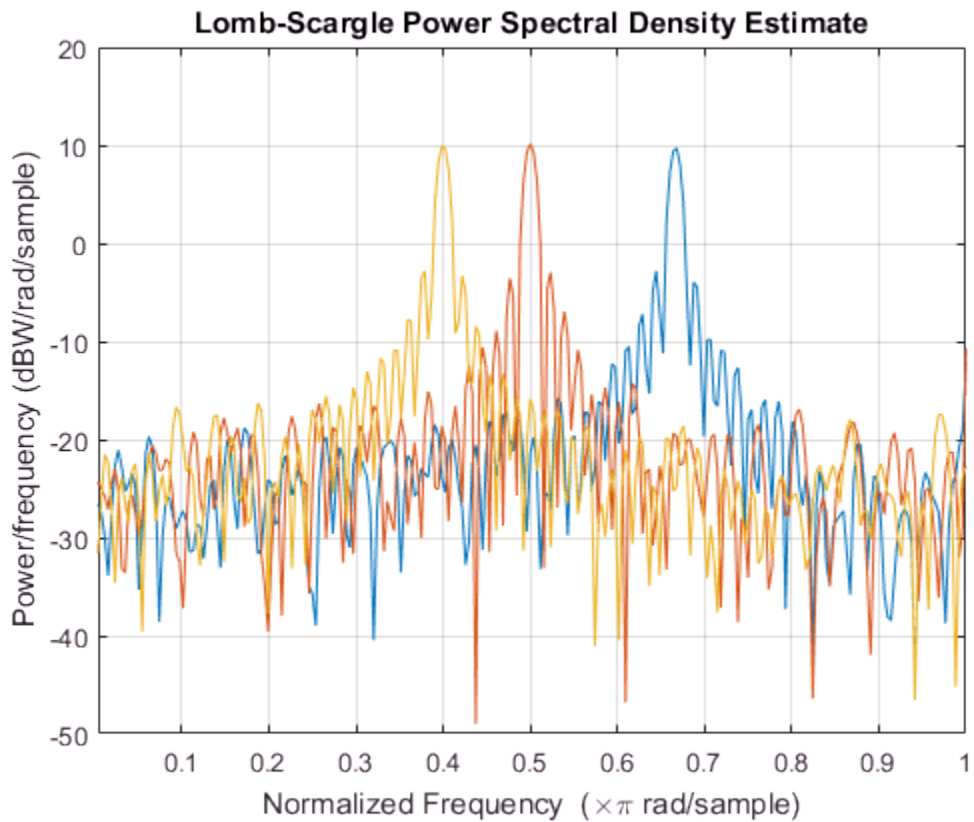

Compute the PSD estimate again, but now remove 25% of the data at random.

```
x3(randperm(numel(x3),0.25*numel(x3))) = NaN;
```

```
plomb(x3)
```

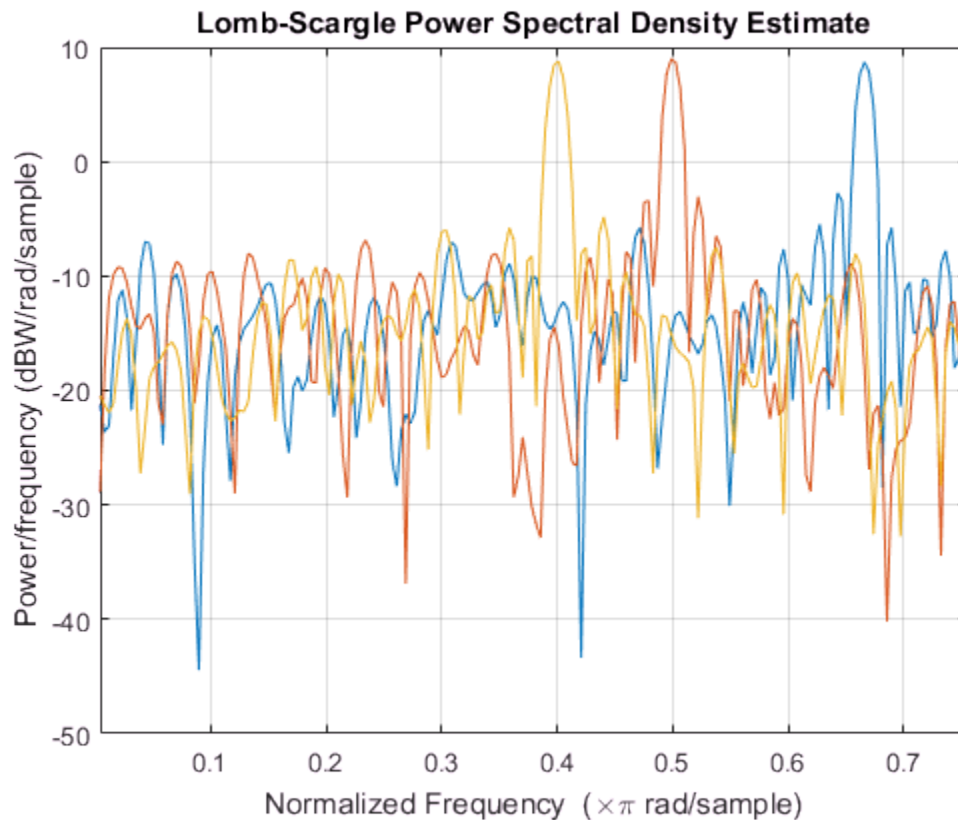

Power Spectral Density of Signal with Missing Samples

If you do not have a time vector, use NaN's to specify missing samples in a signal.

Generate 1024 samples of a sinusoid of normalized frequency $2\pi/5$ rad/sample embedded in white noise of variance 1/100. Estimate the power spectral density using the Lomb-Scargle procedure. Use `plomb` with no output arguments to plot the estimate.

```
t = (0:1023)';
x = sin(2*pi*t/5);
x = x + randn(size(x))/10;
```

```
[pxx,f] = plomb(x);
```

```
plomb(x)
```

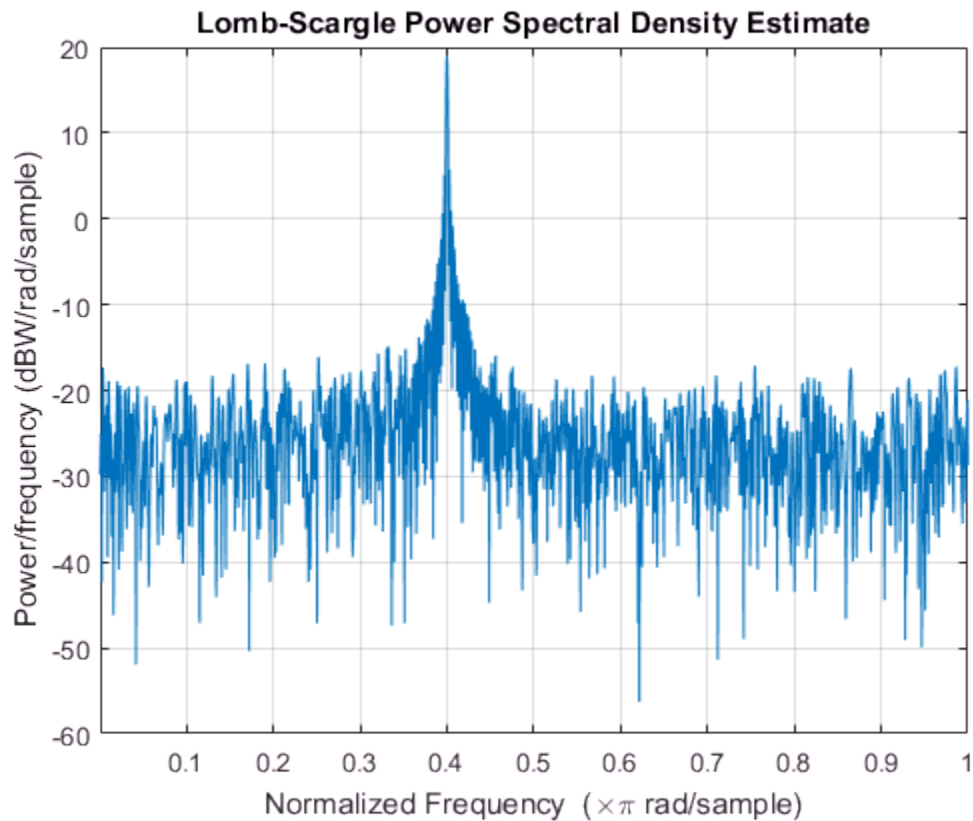

Remove every other sample by assigning NaN's. Use `plomb` to compute and plot the PSD. The periodogram peaks at the same frequency because the time axis is unchanged.

```
xnew = x;  
xnew(2:2:end) = NaN;
```

```
plomb(xnew)
```

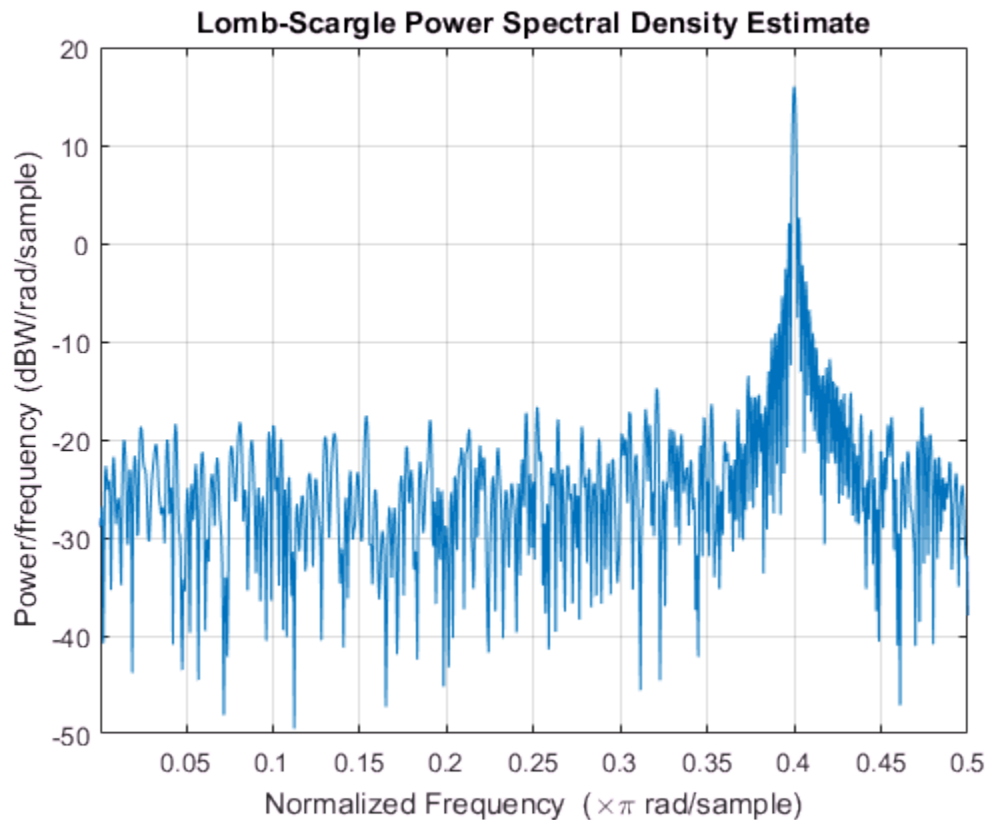
Remove every other sample by downsampling. The function now estimates the periodicity at twice the original frequency. This is probably not the result you want.

```
xdec = x(1:2:end);
```

```
plomb(xdec)
```

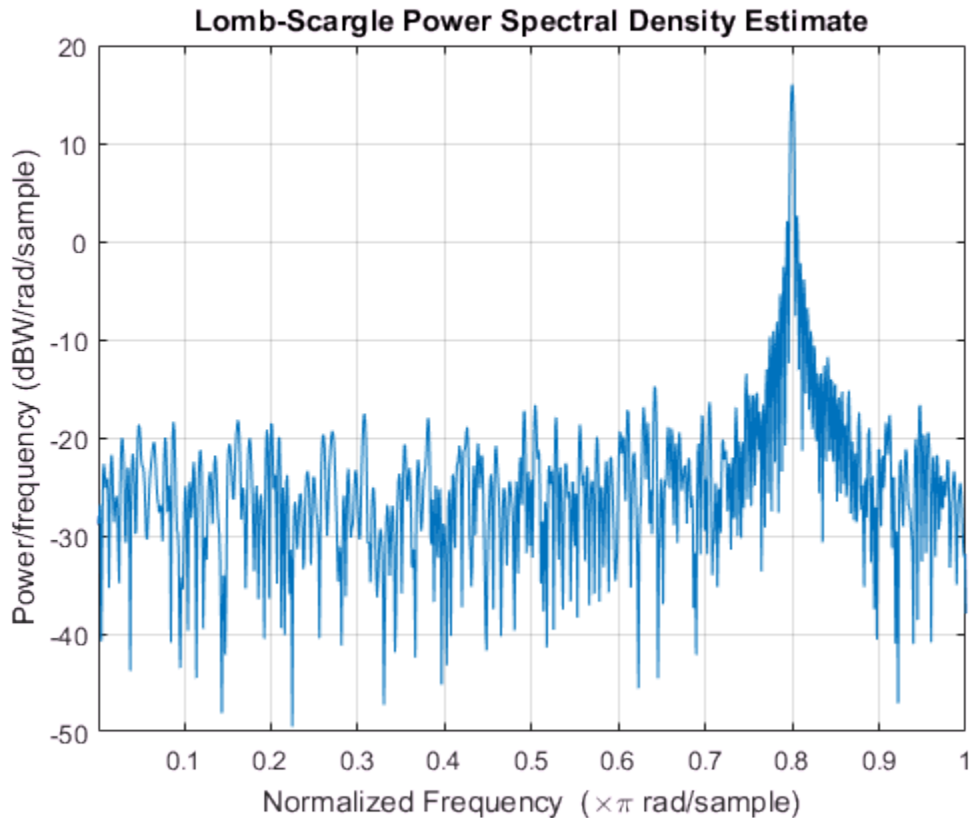

- “Detect Periodicity in a Signal with Missing Samples”
- “Spectral Analysis of Nonuniformly Sampled Signals”

Input Arguments

x — Input signal

vector | matrix

Input signal, specified as a vector or matrix. If **x** is a vector, it is treated as a single channel. If **x** is a matrix, then `plomb` computes the PSD estimate independently for each

column and returns it in the corresponding column of `pxx`. `x` can contain NaNs. NaNs are treated as missing data and are excluded from the spectrum computation.

Data Types: `single` | `double`

t — Time instants

nonnegative real vector | `datetime` array | `duration` array

Time instants, specified as a nonnegative real vector, a `datetime` array, or a `duration` array. `t` must increase monotonically but need not be uniformly spaced. `t` can contain NaNs or NATs. These values are treated as missing data and excluded from the spectrum computation.

Data Types: `single` | `double` | `datetime` | `duration`

fs — Sample rate

positive scalar

Sample rate, specified as a positive scalar. The sample rate is the number of samples per unit time. If the unit of time is seconds, the sample rate has units of hertz.

Data Types: `single` | `double`

fmax — Maximum frequency

positive scalar

Maximum frequency, specified as a positive scalar. `fmax` can be higher than the Nyquist frequency.

Data Types: `single` | `double`

ofac — Oversampling factor

4 (default) | positive integer scalar

Oversampling factor, specified as a positive integer scalar.

Data Types: `single` | `double`

fvec — Input frequencies

vector

Input frequencies, specified as a vector. `fvec` must have at least two elements.

Data Types: `single` | `double`

spectrumtype — Power spectrum scaling

'psd' (default) | 'power' | 'normalized'

Power spectrum scaling, specified as one of 'psd', 'power', or 'normalized'. Omitting **spectrumtype**, or specifying 'psd', returns the power spectral density estimate. Specifying 'power' scales each estimate of the PSD by the equivalent noise bandwidth of the window. Specify 'power' to obtain an estimate of the power at each frequency. Specifying 'normalized' scales **pxx** by two times the variance of **x**.

Data Types: char

pdvec — Probabilities of detection

scalar | vector

Probabilities of detection, specified as the comma-separated pair consisting of 'Pd' and a scalar or a vector of real values between 0 and 1, exclusive. The probability of detection is the probability that a peak in the spectrum is not due to random fluctuations.

Data Types: single | double

Output Arguments

pxx — Lomb-Scargle periodogram

vector | matrix

Lomb-Scargle periodogram, returned as a vector or matrix. When the input signal, **x**, is a vector, then **pxx** is a vector. When **x** is a matrix, the function treats each column of **x** as an independent channel and computes the periodogram of each channel.

f — Frequencies

vector

Frequencies, returned as a vector.

Data Types: single | double

w — Normalized frequencies

vector

Normalized frequencies, returned as a vector.

Data Types: single | double

pth — Power-level thresholds

vector | matrix

Power-level thresholds, returned as a vector or matrix. The power-level threshold is the amplitude that a peak in the spectrum must exceed so it can be ruled out (with probability `pvec`) that the peak is due to random fluctuations. Each row of `pth` corresponds to an element of `pvec`. `pth` has the same number of channels as `x`.

Data Types: single | double

Definitions**Lomb-Scargle Periodogram**

The Lomb-Scargle periodogram lets you find and test weak periodic signals in otherwise random, unevenly sampled data.

Consider N observations, x_k , taken at times t_k , where $k = 1, \dots, N$. The Lomb-Scargle periodogram is defined by [1]

$$P_{\text{LS}}(f) = \frac{1}{2\sigma^2} \left\{ \frac{\left[\sum_{k=1}^N (x_k - \bar{x}) \cos(2\pi f(t_k - \tau)) \right]^2}{\sum_{k=1}^N \cos^2(2\pi f(t_k - \tau))} + \frac{\left[\sum_{k=1}^N (x_k - \bar{x}) \sin(2\pi f(t_k - \tau)) \right]^2}{\sum_{k=1}^N \sin^2(2\pi f(t_k - \tau))} \right\},$$

where

$$\bar{x} = \frac{1}{N} \sum_{k=1}^N x_k$$

and

$$\sigma^2 = \frac{1}{N-1} \sum_{k=1}^N (x_k - \bar{x})^2$$

are respectively the mean and the variance of the data.

The time offset, τ , is chosen as

$$\tan(2(2\pi f)\tau) = \frac{\sum_{k=1}^N \sin(2(2\pi f)t_k)}{\sum_{k=1}^N \cos(2(2\pi f)t_k)}$$

to guarantee the time invariance of the computed spectrum. Any shift $t_k \rightarrow t_k + T$ in the time measurements results in an identical shift in the offset: $\tau \rightarrow \tau + T$. Moreover, the choice ensures that “a maximum in the periodogram occurs at the same frequency which minimizes the sum of squares of the residuals of the fit of a sine wave to the data.” [2] The offset depends only on the measurement times and vanishes when the times are equally spaced.

If the input signal consists of white Gaussian noise, then $P_{LS}(f)$ follows an exponential probability distribution with unit mean [3].

References

- [1] Lomb, Nicholas R. “Least-Squares Frequency Analysis of Unequally Spaced Data.” *Astrophysics and Space Science*. Vol. 39, 1976, pp.447–462.
- [2] Scargle, Jeffrey D. “Studies in Astronomical Time Series Analysis. II. Statistical Aspects of Spectral Analysis of Unevenly Spaced Data.” *Astrophysical Journal*. Vol. 263, 1982, pp.835–853.
- [3] Press, William H., and George B. Rybicki. “Fast Algorithm for Spectral Analysis of Unevenly Sampled Data.” *Astrophysical Journal*. Vol. 338, 1989, pp.277–280.
- [4] Horne, James H., and Sallie L. Baliunas. “A Prescription for Period Analysis of Unevenly Sampled Time Series.” *Astrophysical Journal*. Vol. 302, 1986, pp.757–763.

See Also

See Also

bandpower | pburg | pcov | peig | periodogram | pmcov | pmtm | pmusic |
pwelch | pyulear | spectrogram

Topics

“Detect Periodicity in a Signal with Missing Samples”

“Spectral Analysis of Nonuniformly Sampled Signals”

Introduced in R2014b

pmcov

Autoregressive power spectral density estimate — modified covariance method

Syntax

```
pxx = pmcov(x,order)
pxx = pmcov(x,order,nfft)

[pxx,w] = pmcov( ___ )
[pxx,f] = pmcov( ___ ,fs)

[pxx,w] = pmcov(x,order,w)
[pxx,f] = pmcov(x,order,f,fs)

[ ___ ] = pmcov(x,order, ___ ,freqrange)

[ ___ ,pxxc] = pmcov( ___ ,'ConfidenceLevel',probability)

pmcov( ___ )
```

Description

`pxx = pmcov(x,order)` returns the power spectral density estimate, `pxx`, of a discrete-time signal, `x`, found using the modified covariance method. When `x` is a vector, it is treated as a single channel. When `x` is a matrix, the PSD is computed independently for each column and stored in the corresponding column of `pxx`. `pxx` is the distribution of power per unit frequency. The frequency is expressed in units of rad/sample. `order` is the order of the autoregressive (AR) model used to produce the PSD estimate.

`pxx = pmcov(x,order,nfft)` uses `nfft` points in the discrete Fourier transform (DFT). For real `x`, `pxx` has length $(nfft/2+1)$ if `nfft` is even, and $(nfft+1)/2$ if `nfft` is odd. For complex-valued `x`, `pxx` always has length `nfft`. If you omit `nfft`, or specify it as empty, then `pmcov` uses a default DFT length of 256.

`[pxx,w] = pmcov(___)` returns the vector of normalized angular frequencies, `w`, at which the PSD is estimated. `w` has units of rad/sample. For real-valued signals, `w` spans the interval $[0,\pi]$ when `nfft` is even and $[0,\pi)$ when `nfft` is odd. For complex-valued signals, `w` always spans the interval $[0,2\pi)$.

`[pxx,f] = pmcov(____, fs)` returns a frequency vector, `f`, in cycles per unit time. The sampling frequency, `fs`, is the number of samples per unit time. If the unit of time is seconds, then `f` is in cycles/second (Hz). For real-valued signals, `f` spans the interval `[0,fs/2]` when `nfft` is even and `[0,fs/2)` when `nfft` is odd. For complex-valued signals, `f` spans the interval `[0,fs)`.

`[pxx,w] = pmcov(x,order,w)` returns the two-sided AR PSD estimates at the normalized frequencies specified in the vector, `w`. The vector, `w`, must contain at least two elements.

`[pxx,f] = pmcov(x,order,f,fs)` returns the two-sided AR PSD estimates at the frequencies specified in the vector, `f`. The vector, `f`, must contain at least two elements. The frequencies in `f` are in cycles per unit time. The sampling frequency, `fs`, is the number of samples per unit time. If the unit of time is seconds, then `f` is in cycles/second (Hz).

`[____] = pmcov(x,order, ____, freqrange)` returns the AR PSD estimate over the frequency range specified by `freqrange`. Valid options for `freqrange` are: `'onesided'`, `'twosided'`, or `'centered'`.

`[____,pxxc] = pmcov(____, 'ConfidenceLevel',probability)` returns the `probability` × 100% confidence intervals for the PSD estimate in `pxxc`.

`pmcov(____)` with no output arguments plots the AR PSD estimate in dB per unit frequency in the current figure window.

Examples

Modified-Covariance PSD Estimate of AR(4) Process

Create a realization of an AR(4) wide-sense stationary random process. Estimate the PSD using the modified covariance method. Compare the PSD estimate based on a single realization to the true PSD of the random process.

Create an AR(4) system function. Obtain the frequency response and plot the PSD of the system.

```
A = [1 -2.7607 3.8106 -2.6535 0.9238];
[H,F] = freqz(1,A,[],1);
plot(F,20*log10(abs(H)))
```

```
xlabel('Frequency (Hz)')  
ylabel('PSD (dB/Hz)')
```

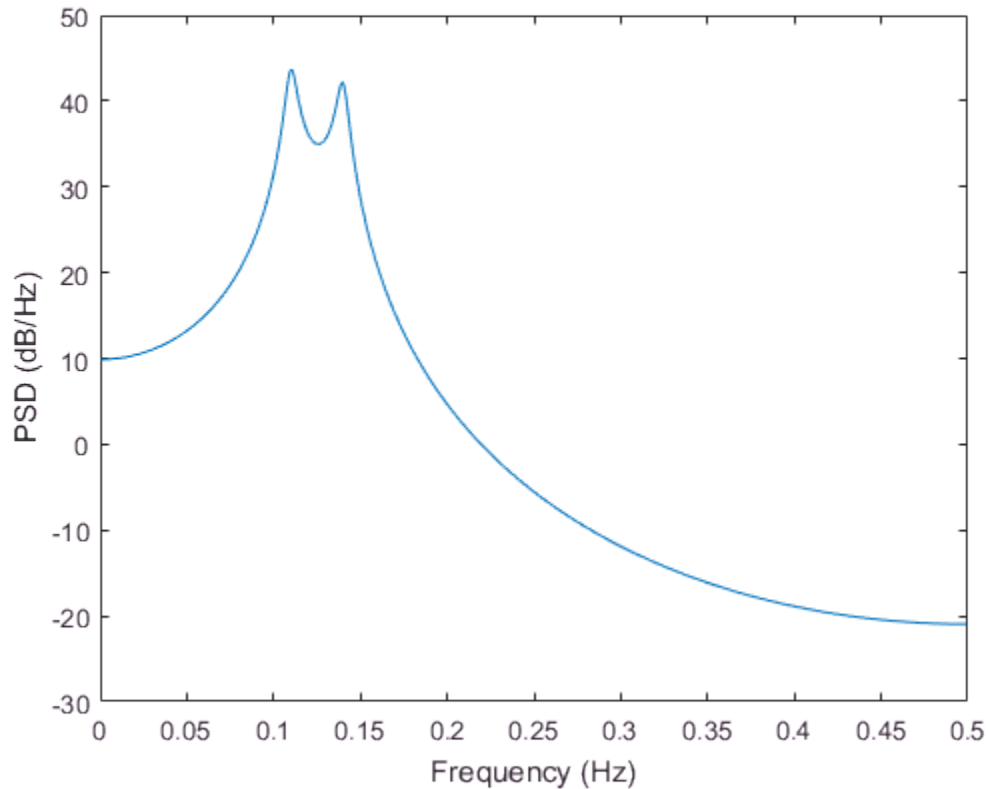

Create a realization of the AR(4) random process. Set the random number generator to the default settings for reproducible results. The realization is 1000 samples in length. Assume a sampling frequency of 1 Hz. Use `pmcov` to estimate the PSD for a 4th-order process. Compare the PSD estimate with the true PSD.

```
rng default  
  
x = randn(1000,1);  
y = filter(1,A,x);  
[Pxx,F] = pmcov(y,4,1024,1);
```

```

hold on
plot(F,10*log10(Pxx))
legend('True Power Spectral Density','pmcov PSD Estimate')

```

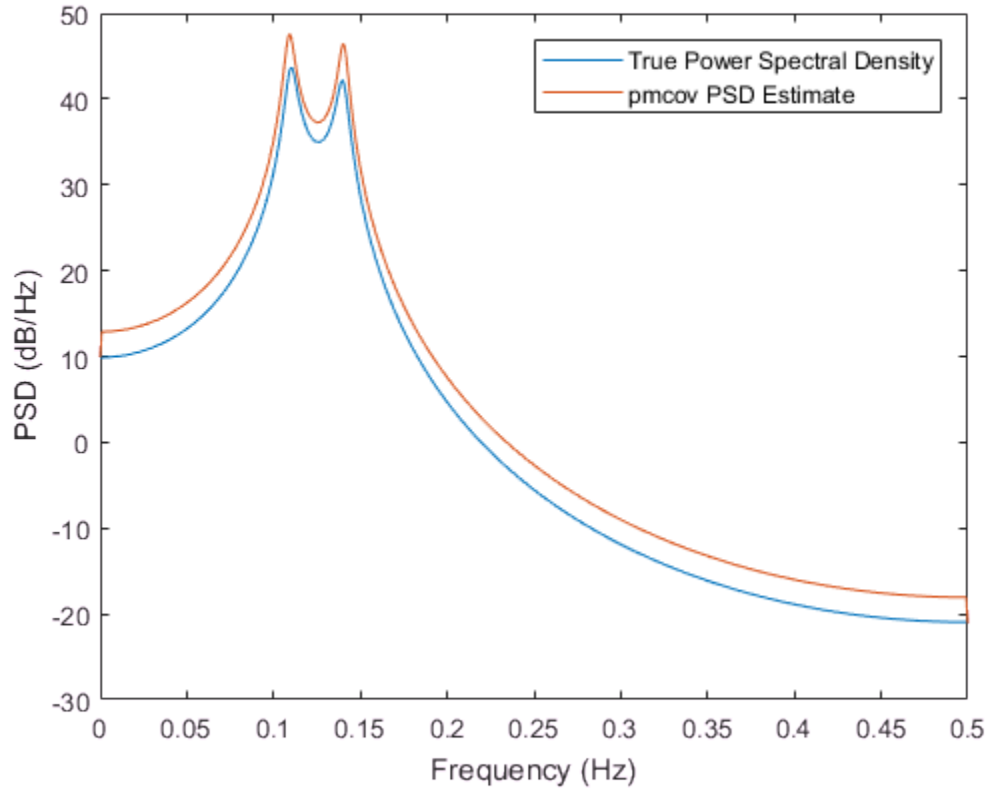

Modified-Covariance PSD Estimate of a Multichannel Signal

Create a multichannel signal consisting of three sinusoids in additive $N(0, 1)$ white Gaussian noise. The sinusoids' frequencies are 100 Hz, 200 Hz, and 300 Hz. The sampling frequency is 1 kHz, and the signal has a duration of 1 s.

$F_s = 1000;$

```
t = 0:1/Fs:1-1/Fs;
f = [100;200;300];
x = cos(2*pi*f*t)' + randn(length(t),3);
```

Estimate the PSD of the signal using the modified covariance method with a 12th-order autoregressive model. Use the default DFT length. Plot the estimate.

```
morder = 12;
pmcov(x,morder,[],Fs)
```

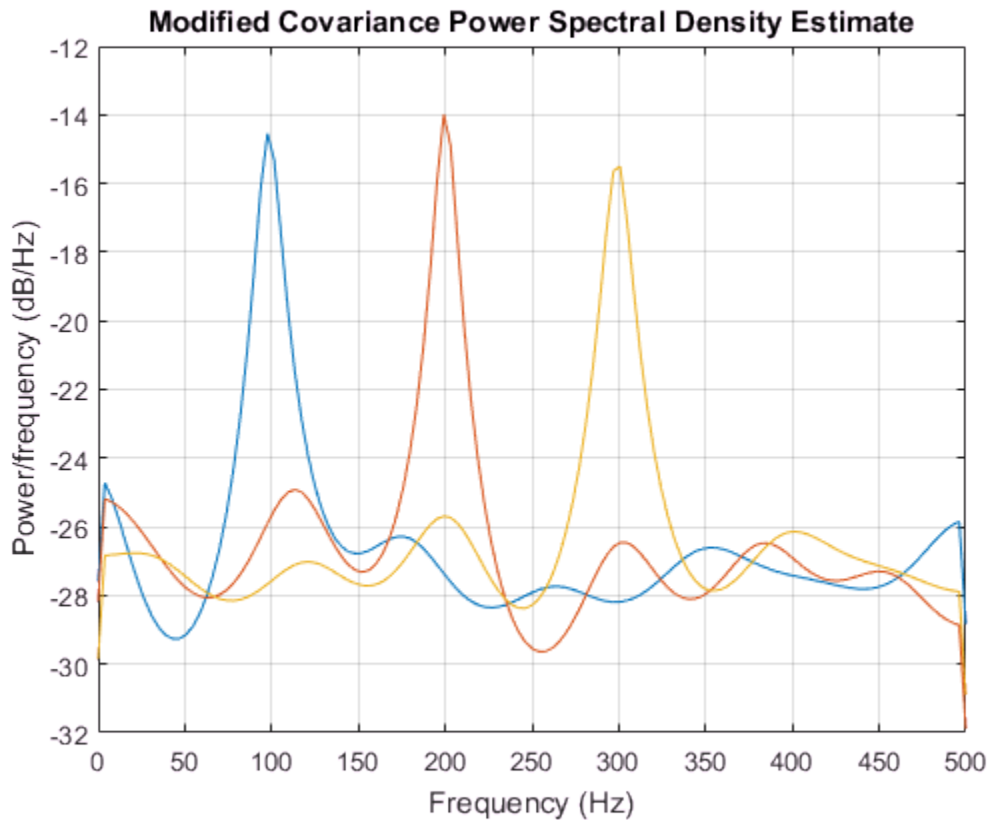

Input Arguments

x — Input signal

vector | matrix

Input signal, specified as a row or column vector, or as a matrix. If **x** is a matrix, then its columns are treated as independent channels.

Example: `cos(pi/4*(0:159))+randn(1,160)` is a single-channel row-vector signal.

Example: `cos(pi./[4;2]*(0:159))'+randn(160,2)` is a two-channel signal.

Data Types: `single` | `double`

Complex Number Support: Yes

order — Order of autoregressive model

positive integer

Order of the autoregressive model, specified as a positive integer.

Data Types: `double`

nfft — Number of DFT points

256 (default) | integer | []

Number of DFT points, specified as a positive integer. For a real-valued input signal, **x**, the PSD estimate, **pxx** has length $(nfft/2+1)$ if **nfft** is even, and $(nfft+1)/2$ if **nfft** is odd. For a complex-valued input signal, **x**, the PSD estimate always has length **nfft**. If **nfft** is specified as empty, the default **nfft** is used.

Data Types: `single` | `double`

fs — Sample rate

positive scalar

Sample rate, specified as a positive scalar. The sample rate is the number of samples per unit time. If the unit of time is seconds, then the sample rate has units of Hz.

w — Normalized frequencies

vector

Normalized frequencies, specified as a row or column vector with at least two elements. Normalized frequencies are in rad/sample.

Example: `w = [pi/4 pi/2]`

Data Types: double

f — Frequencies

vector

Frequencies, specified as a row or column vector with at least two elements. The frequencies are in cycles per unit time. The unit time is specified by the sample rate, `fs`. If `fs` has units of samples/second, then `f` has units of Hz.

Example: `fs = 1000; f = [100 200]`

Data Types: double

freqrange — Frequency range for PSD estimate

'onesided' | 'twosided' | 'centered'

Frequency range for the PSD estimate, specified as a one of 'onesided', 'twosided', or 'centered'. The default is 'onesided' for real-valued signals and 'twosided' for complex-valued signals. The frequency ranges corresponding to each option are

- 'onesided' — returns the one-sided PSD estimate of a real-valued input signal, `x`. If `nfft` is even, `pxx` has length $nfft/2 + 1$ and is computed over the interval $[0, \pi]$ rad/sample. If `nfft` is odd, the length of `pxx` is $(nfft + 1)/2$ and the interval is $[0, \pi)$ rad/sample. When `fs` is optionally specified, the corresponding intervals are $[0, fs/2]$ cycles/unit time and $[0, fs/2)$ cycles/unit time for even and odd length `nfft` respectively.
- 'twosided' — returns the two-sided PSD estimate for either the real-valued or complex-valued input, `x`. In this case, `pxx` has length `nfft` and is computed over the interval $[0, 2\pi)$ rad/sample. When `fs` is optionally specified, the interval is $[0, fs)$ cycles/unit time.
- 'centered' — returns the centered two-sided PSD estimate for either the real-valued or complex-valued input, `x`. In this case, `pxx` has length `nfft` and is computed over the interval $(-\pi, \pi]$ rad/sample for even length `nfft` and $(-\pi, \pi)$ rad/sample for odd length `nfft`. When `fs` is optionally specified, the corresponding intervals are $(-fs/2, fs/2]$ cycles/unit time and $(-fs/2, fs/2)$ cycles/unit time for even and odd length `nfft` respectively.

Data Types: char

probability — Confidence interval for PSD estimate

0.95 (default) | scalar in the range (0,1)

Coverage probability for the true PSD, specified as a scalar in the range (0,1). The output, `pxxc`, contains the lower and upper bounds of the `probability × 100%` interval estimate for the true PSD.

Output Arguments

pxx — PSD estimate

vector | matrix

PSD estimate, returned as a real-valued, nonnegative column vector or matrix. Each column of `pxx` is the PSD estimate of the corresponding column of `x`. The units of the PSD estimate are in squared magnitude units of the time series data per unit frequency. For example, if the input data is in volts, the PSD estimate is in units of squared volts per unit frequency. For a time series in volts, if you assume a resistance of 1Ω and specify the sample rate in hertz, the PSD estimate is in watts per hertz.

Data Types: `single` | `double`

w — Normalized frequencies

vector

Normalized frequencies, returned as a real-valued column vector. If `pxx` is a one-sided PSD estimate, `w` spans the interval $[0, \pi]$ if `nfft` is even and $[0, \pi)$ if `nfft` is odd. If `pxx` is a two-sided PSD estimate, `w` spans the interval $[0, 2\pi)$. For a DC-centered PSD estimate, `w` spans the interval $(-\pi, \pi]$ for even `nfft` and $(-\pi, \pi)$ for odd `nfft`.

Data Types: `double`

f — Cyclical frequencies

vector

Cyclical frequencies, returned as a real-valued column vector. For a one-sided PSD estimate, `f` spans the interval $[0, fs/2]$ when `nfft` is even and $[0, fs/2)$ when `nfft` is odd. For a two-sided PSD estimate, `f` spans the interval $[0, fs)$. For a DC-centered PSD estimate, `f` spans the interval $(-fs/2, fs/2]$ cycles/unit time for even length `nfft` and $(-fs/2, fs/2)$ cycles/unit time for odd length `nfft`.

Data Types: `double`

pxxc — Confidence bounds

matrix

Confidence bounds, returned as a matrix with real-valued elements. The row size of the matrix is equal to the length of the PSD estimate, `pxx`. `pxxc` has twice as many columns as `pxx`. Odd-numbered columns contain the lower bounds of the confidence intervals, and even-numbered columns contain the upper bounds. Thus, `pxxc(m, 2*n - 1)` is the lower confidence bound and `pxxc(m, 2*n)` is the upper confidence bound corresponding to the estimate `pxx(m, n)`. The coverage probability of the confidence intervals is determined by the value of the `probability` input.

Data Types: `single` | `double`

See Also

See Also

`pburg` | `pcov` | `pyulear`

Introduced before R2006a

pmtm

Multitaper power spectral density estimate

Syntax

```

pxx = pmtm(x)
pxx = pmtm(x,nw)
pxx = pmtm(x,nw,nfft)

[pxx,w] = pmtm(____)
[pxx,f] = pmtm(____,fs)

[pxx,w] = pmtm(x,nw,w)
[pxx,f] = pmtm(x,nw,f,fs)

[____] = pmtm(____,method)

[____] = pmtm(x,e,v)
[____] = pmtm(x,dpss_params)

[____] = pmtm(____,'DropLastTaper',dropflag)
[____] = pmtm(____,freqrange)
[____,pxxc] = pmtm(____,'ConfidenceLevel',probability)

pmtm(____)

```

Description

`pxx = pmtm(x)` returns Thomson's multitaper power spectral density (PSD) estimate, `pxx`, of the input signal, `x`. When `x` is a vector, it is treated as a single channel. When `x` is a matrix, the PSD is computed independently for each column and stored in the corresponding column of `pxx`. The tapers are the discrete prolate spheroidal (DPSS), or Slepian, sequences. The time-halfbandwidth, `nw`, product is 4. By default, `pmtm` uses the first $2nw - 1$ DPSS sequences. If `x` is real-valued, `pxx` is a one-sided PSD estimate. If `x` is complex-valued, `pxx` is a two-sided PSD estimate. The number of points, `nfft`, in the

discrete Fourier transform (DFT) is the maximum of 256 or the next power of two greater than the signal length.

`pxx = pmtm(x, nw)` use the time-halfbandwidth product, `nw`, to obtain the multitaper PSD estimate. The time-halfbandwidth product controls the frequency resolution of the multitaper estimate. `pmtm` uses $2nw - 1$ Slepian tapers in the PSD estimate.

`pxx = pmtm(x, nw, nfft)` uses `nfft` points in the DFT. If `nfft` is greater than the signal length, `x` is zero-padded to length `nfft`. If `nfft` is less than the signal length, the signal is wrapped modulo `nfft`.

`[pxx, w] = pmtm(___)` returns the normalized frequency vector, `w`. If `pxx` is a one-sided PSD estimate, `w` spans the interval $[0, \pi]$ if `nfft` is even and $[0, \pi)$ if `nfft` is odd. If `pxx` is a two-sided PSD estimate, `w` spans the interval $[0, 2\pi)$.

`[pxx, f] = pmtm(___, fs)` returns a frequency vector, `f`, in cycles per unit time. The sampling frequency, `fs`, is the number of samples per unit time. If the unit of time is seconds, then `f` is in cycles/sec (Hz). For real-valued signals, `f` spans the interval $[0, fs/2]$ when `nfft` is even and $[0, fs/2)$ when `nfft` is odd. For complex-valued signals, `f` spans the interval $[0, fs)$. `fs` must be the fourth input to `pmtm`. To input a sample rate and still use the default values of the preceding optional arguments, specify these arguments as empty, `[]`.

`[pxx, w] = pmtm(x, nw, w)` returns the two-sided multitaper PSD estimates at the normalized frequencies specified in the vector, `w`. `w` must contain at least two elements.

`[pxx, f] = pmtm(x, nw, f, fs)` returns the two-sided multitaper PSD estimates at the frequencies specified in the vector, `f`. `f` must contain at least two elements. The frequencies in `f` are in cycles per unit time. The sampling frequency, `fs`, is the number of samples per unit time. If the unit of time is seconds, then `f` is in cycles/second (Hz).

`[___] = pmtm(___, method)` combines the individual tapered PSD estimates using the method, `method`. `method` can be one of: 'adapt' (default), 'eigen', or 'unity'.

`[___] = pmtm(x, e, v)` uses the tapers in the N-by-K matrix `e` with concentrations `v` in the frequency band $[-w, w]$. `N` is the length of the input signal, `x`. Use `dpss` to obtain the Slepian tapers and corresponding concentrations.

`[___] = pmtm(x, dpss_params)` uses the cell array, `dpss_params`, to pass input arguments to `dpss` except the number of elements in the sequences. The number of

elements in the sequences is the first input argument to `dpss` and is not included in `dpss_params`. An example of this usage is `pxx = pmtm(randn(1000,1),{2.5,3})`.

`[___] = pmtm(___, 'DropLastTaper', dropflag)` specifies whether `pmtm` drops the last taper in the computation of the multitaper PSD estimate. `dropflag` is a logical. The default value of `dropflag` is `true` and the last taper is not used in the PSD estimate.

`[___] = pmtm(___, freqrange)` returns the multitaper PSD estimate over the frequency range specified by `freqrange`. Valid options for `freqrange` are `'onesided'`, `'twosided'`, and `'centered'`.

`[___, pxxc] = pmtm(___, 'ConfidenceLevel', probability)` returns the `probability` \times 100% confidence intervals for the PSD estimate in `pxxc`.

`pmtm(___)` with no output arguments plots the multitaper PSD estimate in the current figure window.

Examples

Multitaper Estimate Using Default Inputs

Obtain the multitaper PSD estimate of an input signal consisting of a discrete-time sinusoid with an angular frequency of $\pi/4$ rad/sample with additive $N(0,1)$ white noise.

Create a sine wave with an angular frequency of $\pi/4$ rad/sample with additive $N(0,1)$ white noise. The signal is 320 samples in length. Obtain the multitaper PSD estimate using the default time-halfbandwidth product of 4 and DFT length. The default number of DFT points is 512. Because the signal is real-valued, the PSD estimate is one-sided and there are $512/2+1$ points in the PSD estimate.

```
n = 0:319;
x = cos(pi/4*n)+randn(size(n));
pxx = pmtm(x);
```

Plot the multitaper PSD estimate.

```
pmtm(x)
```

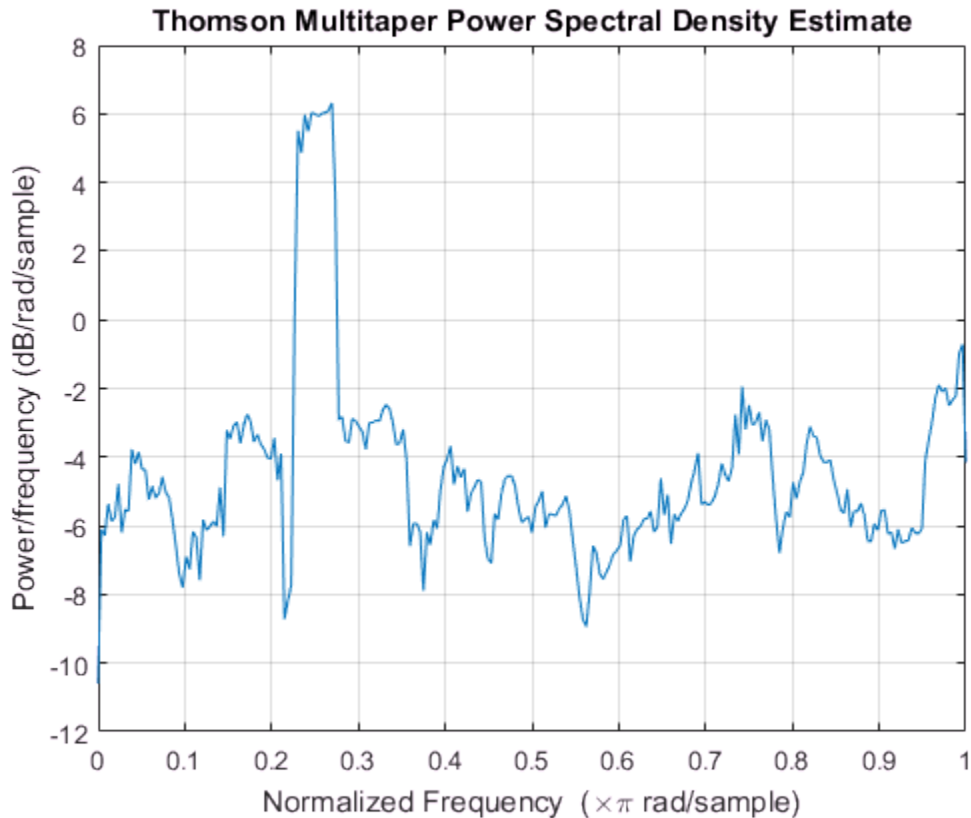

Specify Time-Halfbandwidth Product

Obtain the multitaper PSD estimate with a specified time-halfbandwidth product.

Create a sine wave with an angular frequency of $\pi/4$ rad/sample with additive $N(0,1)$ white noise. The signal is 320 samples in length. Obtain the multitaper PSD estimate with a time-halfbandwidth product of 2.5. The resolution bandwidth is $[-2.5\pi/320, 2.5\pi/320]$ rad/sample. The default number of DFT points is 512. Because the signal is real-valued, the PSD estimate is one-sided and there are $512/2+1$ points in the PSD estimate.

```
n = 0:319;
```

```
x = cos(pi/4*n)+randn(size(n));
pmtm(x,2.5)
```

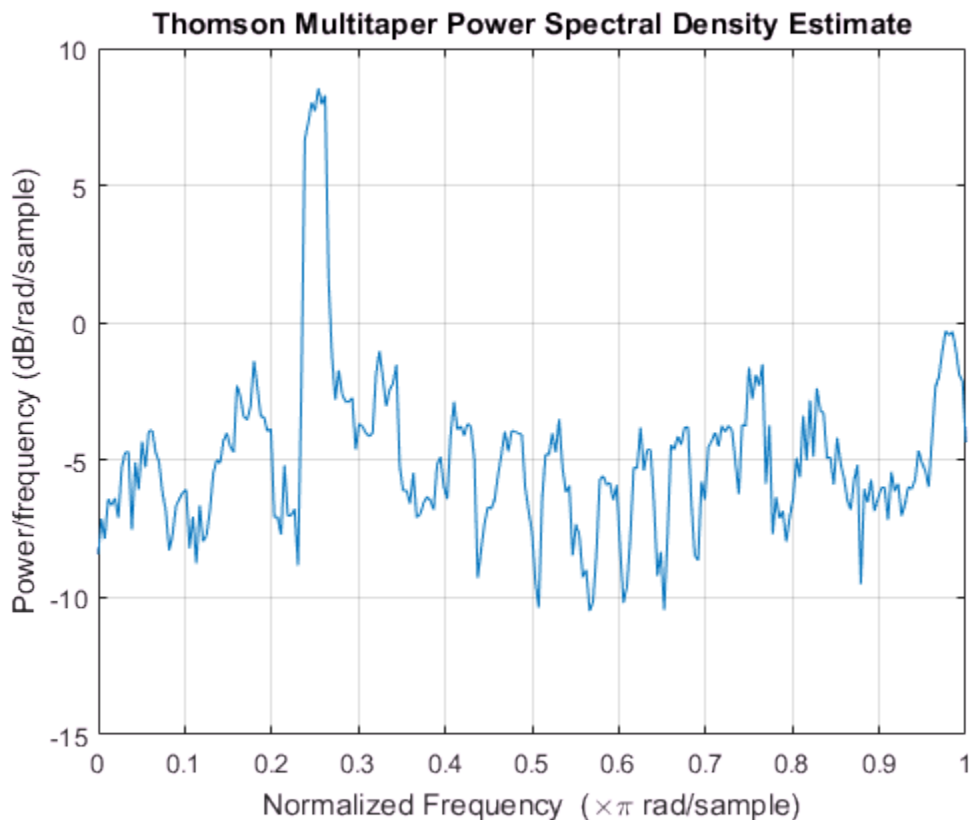

DFT Length Equal to Signal Length

Obtain the multitaper PSD estimate of an input signal consisting of a discrete-time sinusoid with an angular frequency of $\pi/4$ rad/sample with additive $N(0,1)$ white noise. Use a DFT length equal to the signal length.

Create a sine wave with an angular frequency of $\pi/4$ rad/sample with additive $N(0,1)$ white noise. The signal is 320 samples in length. Obtain the multitaper PSD estimate

with a time-halfbandwidth product of 3 and a DFT length equal to the signal length. Because the signal is real-valued, the one-sided PSD estimate is returned by default with a length equal to $320/2+1$.

```
n = 0:319;
x = cos(pi/4*n)+randn(size(n));
pmtm(x,3,length(x))
```

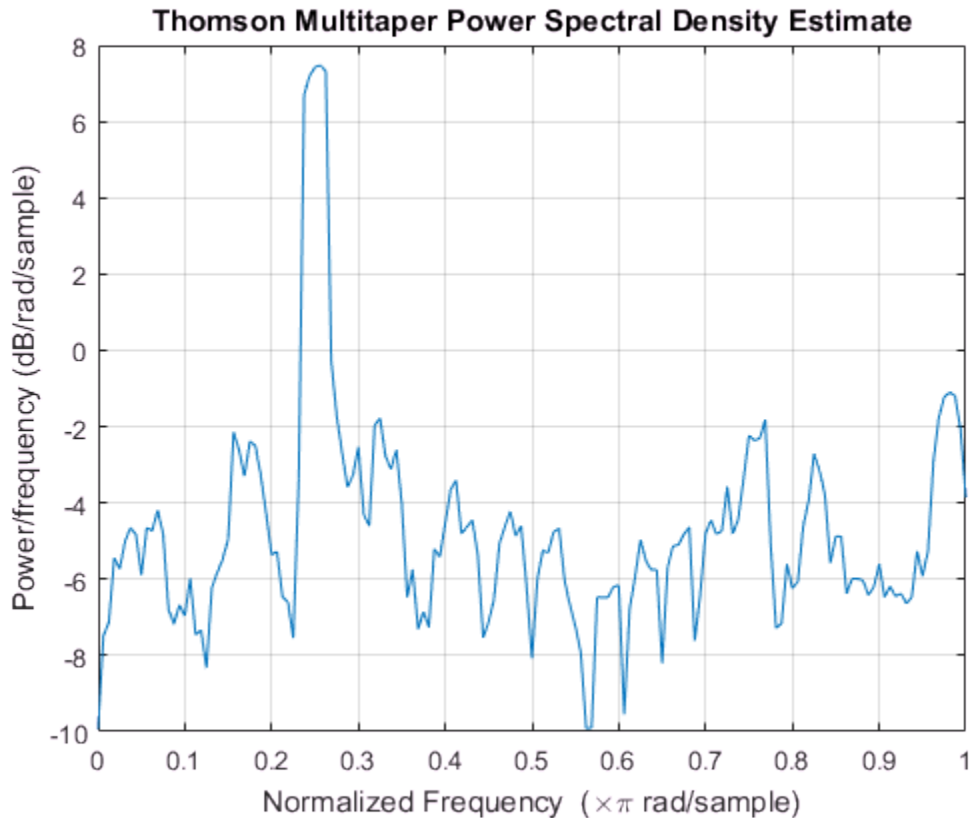

Multitaper Estimate with Sample Rate

Obtain the multitaper PSD estimate of a signal sampled at 1 kHz. The signal is a 100 Hz sine wave in additive $N(0,1)$ white noise. The signal duration is 2 s. Use a time-halfbandwidth product of 3 and DFT length equal to the signal length.

```
fs = 1000;  
t = 0:1/fs:2-1/fs;  
x = cos(2*pi*100*t)+randn(size(t));  
[pxx,f] = pmtm(x,3,length(x),fs);
```

Plot the multitaper PSD estimate.

```
pmtm(x,3,length(x),fs)
```

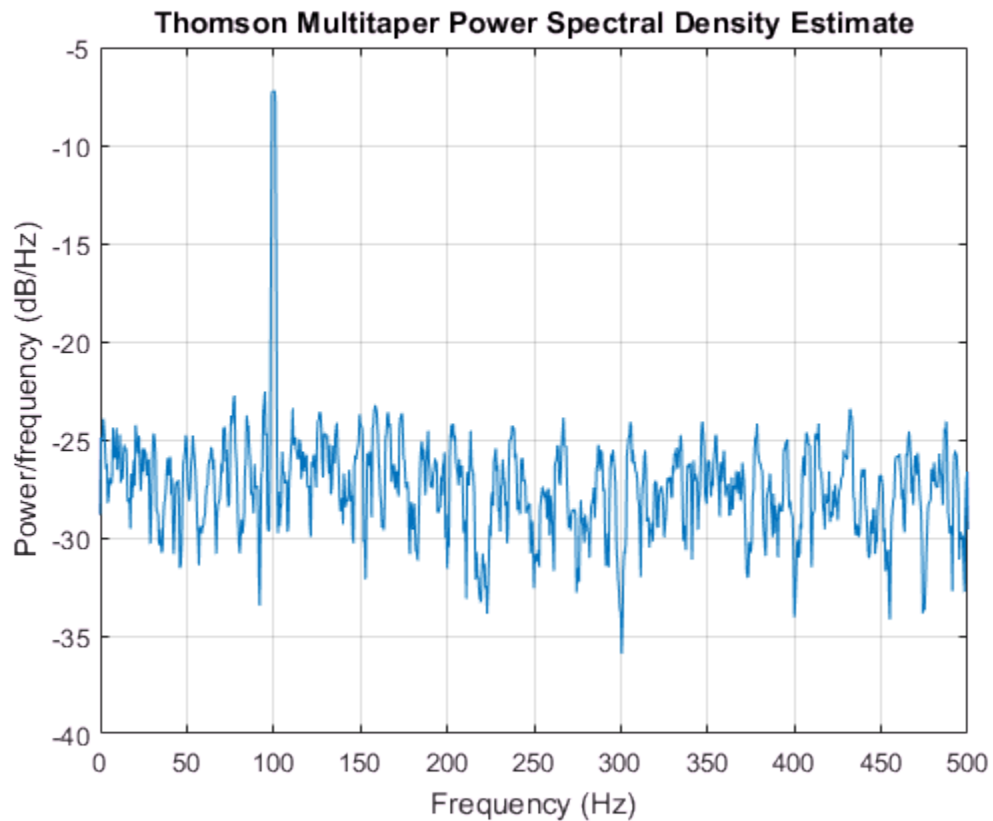

Average Single-Taper Estimates with Unity Weights

Obtain a multitaper PSD estimate where the individual tapered direct spectral estimates are given equal weight in the average.

Obtain the multitaper PSD estimate of a signal sampled at 1 kHz. The signal is a 100 Hz sine wave in additive $N(0,1)$ white noise. The signal duration is 2 s. Use a time-halfbandwidth product of 3 and a DFT length equal to the signal length. Use the 'unity' option to give equal weight in the average to each of the individual tapered direct spectral estimates.

```
fs = 1000;  
t = 0:1/fs:2-1/fs;  
x = cos(2*pi*100*t)+randn(size(t));  
[pxx,f] = pmtm(x,3,length(x),fs,'unity');
```

Plot the multitaper PSD estimate.

```
pmtm(x,3,length(x),fs,'unity')
```

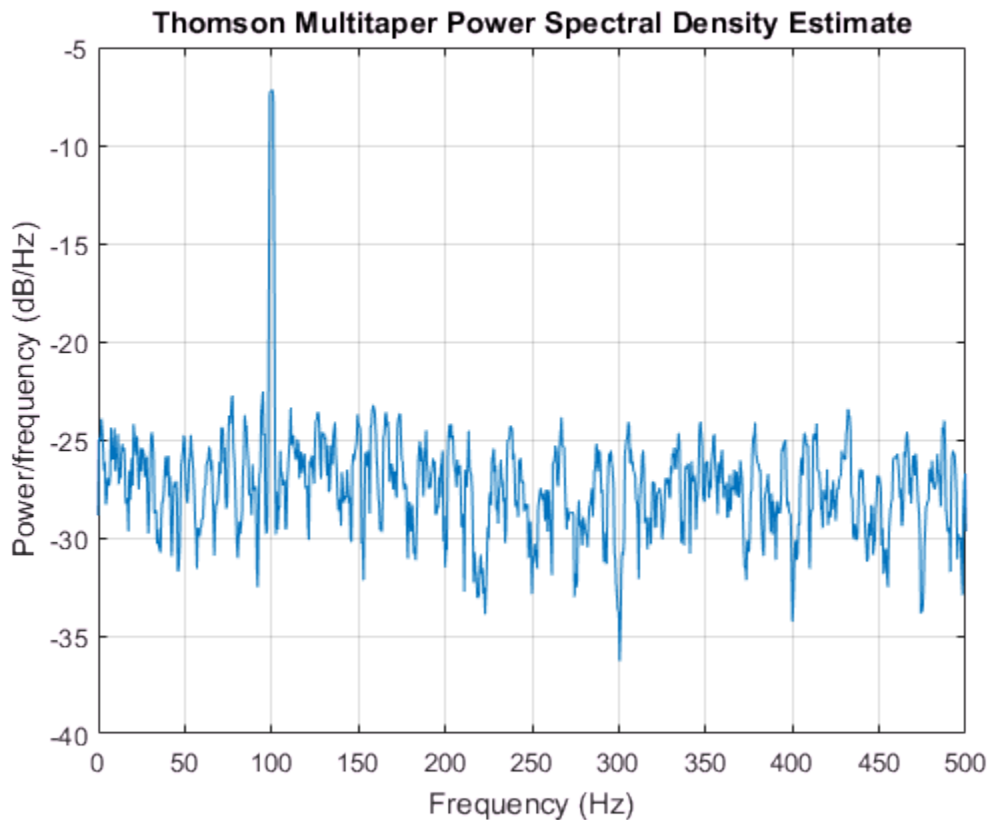

DPSS Sequences and Their Frequency-Domain Concentrations

This example examines the frequency-domain concentrations of the DPSS sequences. The example produces a multitaper PSD estimate of an input signal by precomputing the Slepian sequences and selecting only those with more than 99% of their energy concentrated in the resolution bandwidth.

The signal is a 100 Hz sine wave in additive $N(0,1)$ white noise. The signal duration is 2 s.

```
fs = 1000;  
t = 0:1/fs:2-1/fs;  
x = cos(2*pi*100*t)+randn(size(t));
```

Set the time-halfbandwidth product to 3.5. For the signal length of 2000 samples and a sampling interval of 0.001 seconds, this results in a resolution bandwidth of $[-1.75, 1.75]$ Hz. Calculate the first 10 Slepian sequences and examine their frequency concentrations in the specified resolution bandwidth.

```
[e,v] = dpss(length(x),3.5,10);  
stem(1:length(v),v,'filled')  
ylim([0 1.2])  
title('Proportion of Energy in [-w,w] of k-th Slepian Sequence')
```

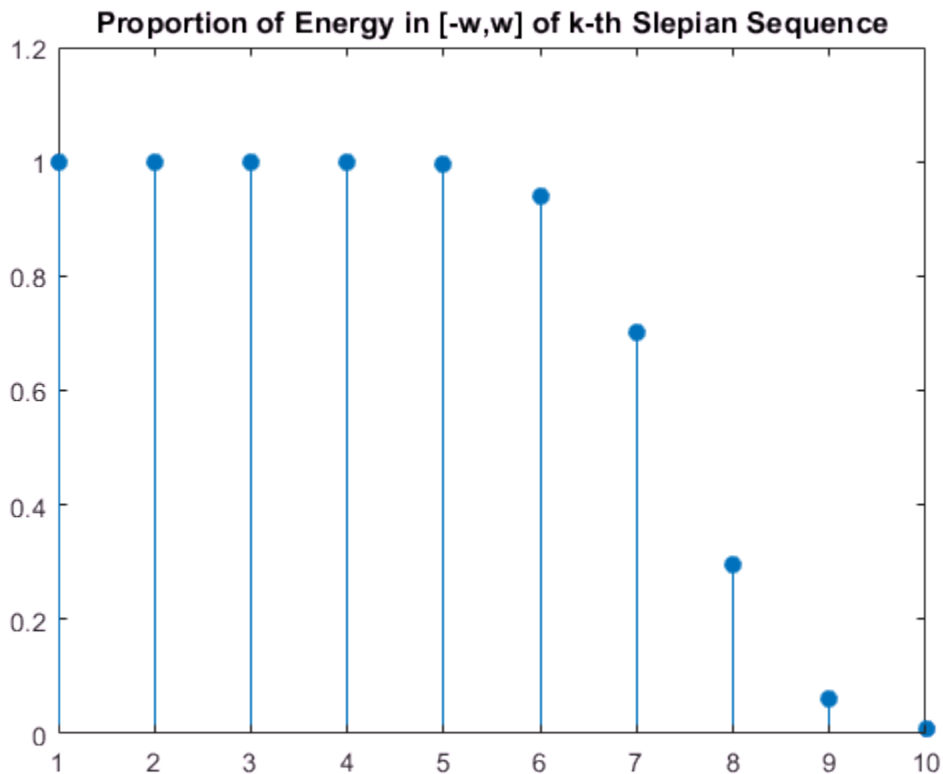

Determine the number of Slepian sequences with energy concentrations greater than 99%. Using the selected DPSS sequences, obtain the multitaper PSD estimate. Set 'DropLastTaper' to false to use all the selected tapers.

```
hold on  
plot(1:length(v),0.99*ones(length(v),1))
```

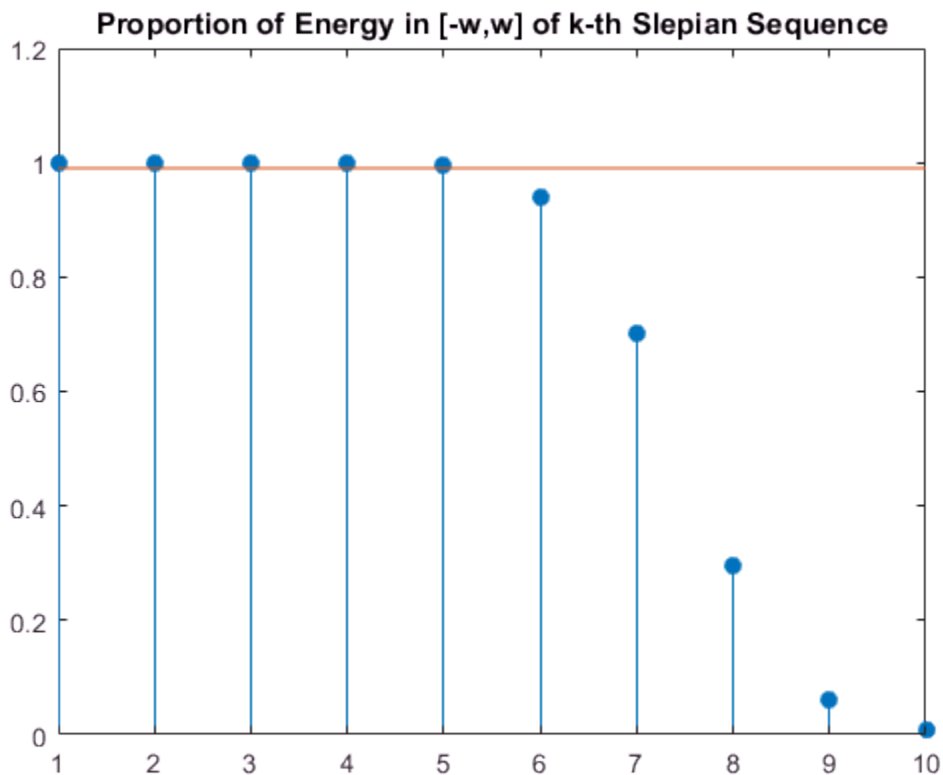

```
idx = find(v>0.99,1,'last')
```

```
idx = 5
```

```
[pxx,f] = pmtm(x,e(:,1:idx),v(1:idx),length(x),fs,'DropLastTaper',false);
```

Plot the multitaper PSD estimate.

```
figure
```

```
pmtm(x,e(:,1:idx),v(1:idx),length(x),fs,'DropLastTaper',false)
```

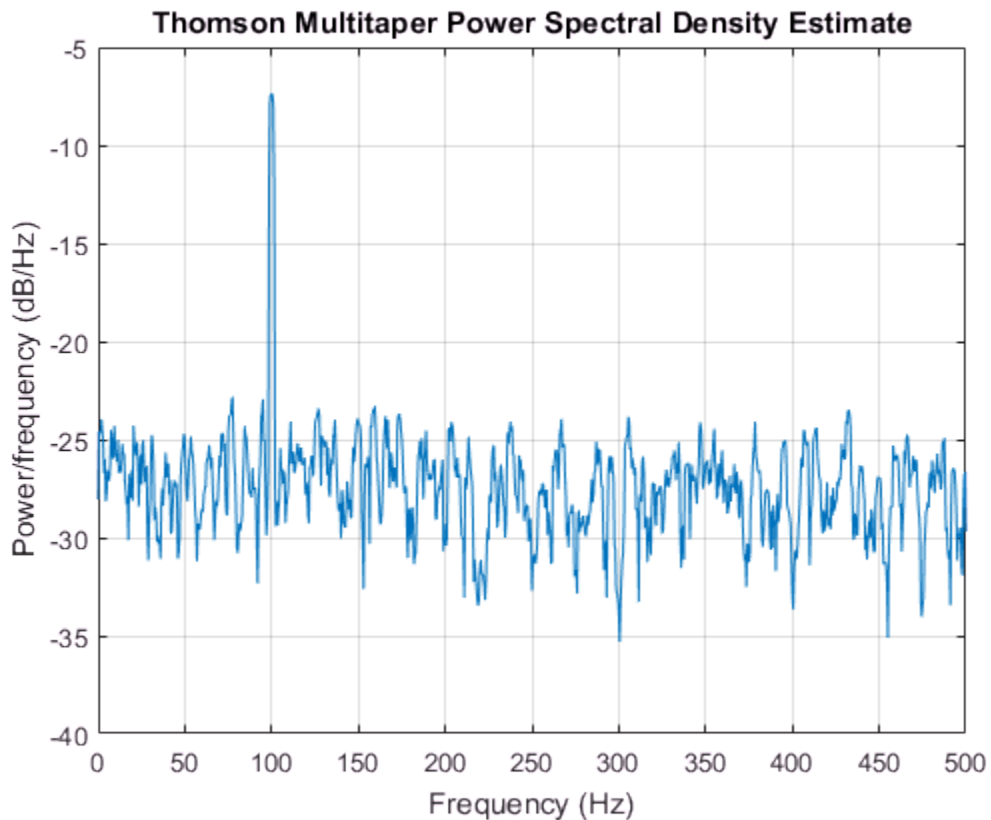

DC-Centered Multitaper PSD Estimate

Obtain the multitaper PSD estimate of a 100 Hz sine wave in additive $N(0,1)$ noise. The data are sampled at 1 kHz. Use the 'centered' option to obtain the DC-centered PSD.

```
fs = 1000;
t = 0:1/fs:2-1/fs;
x = cos(2*pi*100*t)+randn(size(t));
[pxx,f] = pmtm(x,3.5,length(x),fs,'centered');
```

Plot the DC-centered PSD estimate.

```
pmtm(x,3.5,length(x),fs,'centered')
```

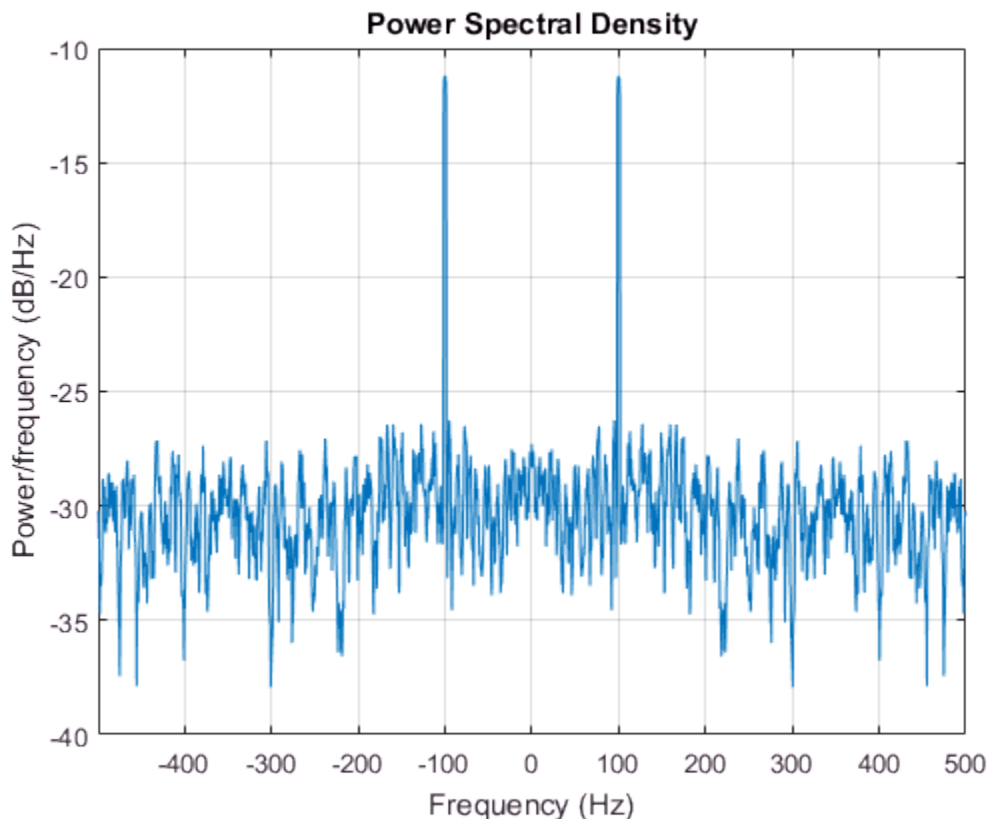

Upper and Lower 95%-Confidence Bounds

The following example illustrates the use of confidence bounds with the multitaper PSD estimate. While not a necessary condition for statistical significance, frequencies in the multitaper PSD estimate where the lower confidence bound exceeds the upper confidence bound for surrounding PSD estimates clearly indicate significant oscillations in the time series.

Create a signal consisting of the superposition of 100-Hz and 150-Hz sine waves in additive white $N(0,1)$ noise. The amplitude of the two sine waves is 1. The sampling frequency is 1 kHz. The signal is 2 s in duration.

```
fs = 1000;
t = 0:1/fs:2-1/fs;
x = cos(2*pi*100*t)+cos(2*pi*150*t)+randn(size(t));
```

Obtain the multitaper PSD estimate with 95%-confidence bounds. Plot the PSD estimate along with the confidence interval and zoom in on the frequency region of interest near 100 and 150 Hz.

```
[pxx,f,pxxc] = pmtm(x,3.5,length(x),fs,'ConfidenceLevel',0.95);

plot(f,10*log10(pxx))
hold on
plot(f,10*log10(pxxc),'r-.')
xlim([85 175])
xlabel('Hz')
ylabel('dB')
title('Multitaper PSD Estimate with 95%-Confidence Bounds')
```

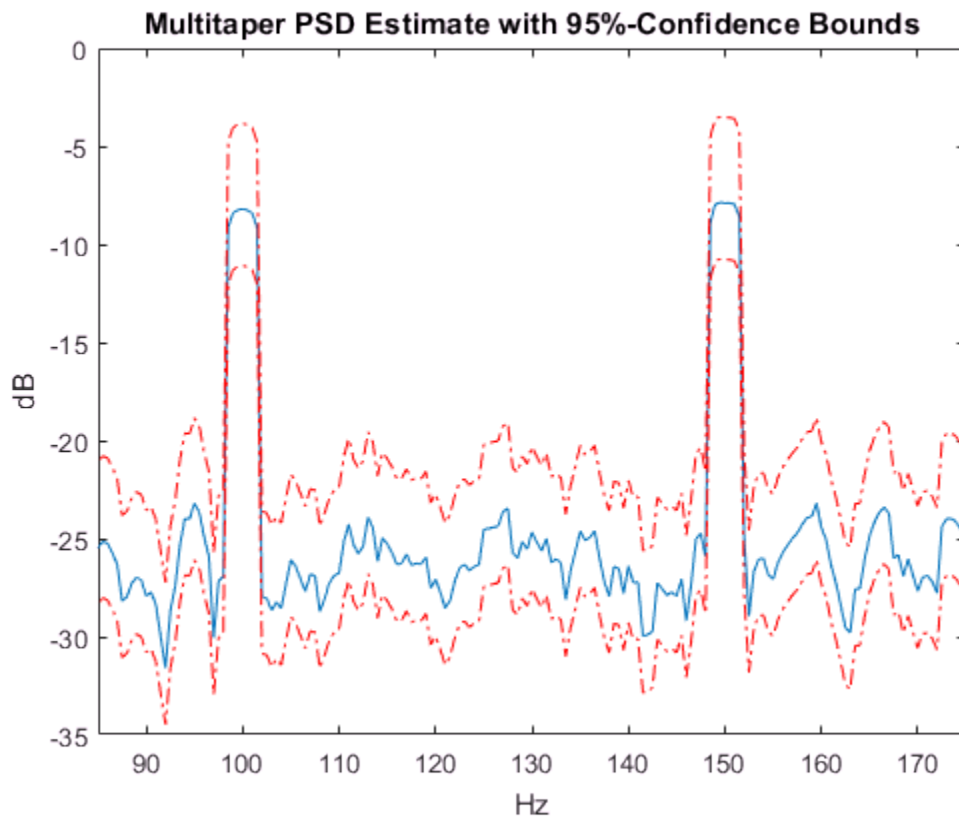

The lower confidence bound in the immediate vicinity of 100 and 150 Hz is significantly above the upper confidence bound outside the vicinity of 100 and 150 Hz.

Multitaper PSD Estimate of a Multichannel Signal

Generate 1024 samples of a multichannel signal consisting of three sinusoids in additive $N(0, 1)$ white Gaussian noise. The sinusoids' frequencies are $\pi/2$, $\pi/3$, and $\pi/4$ rad/sample. Estimate the PSD of the signal using Thomson's multitaper method and plot it.

```
N = 1024;
n = 0:N-1;
```

```
w = pi./[2;3;4];  
x = cos(w*n)' + randn(length(n),3);  
  
pmtm(x)
```

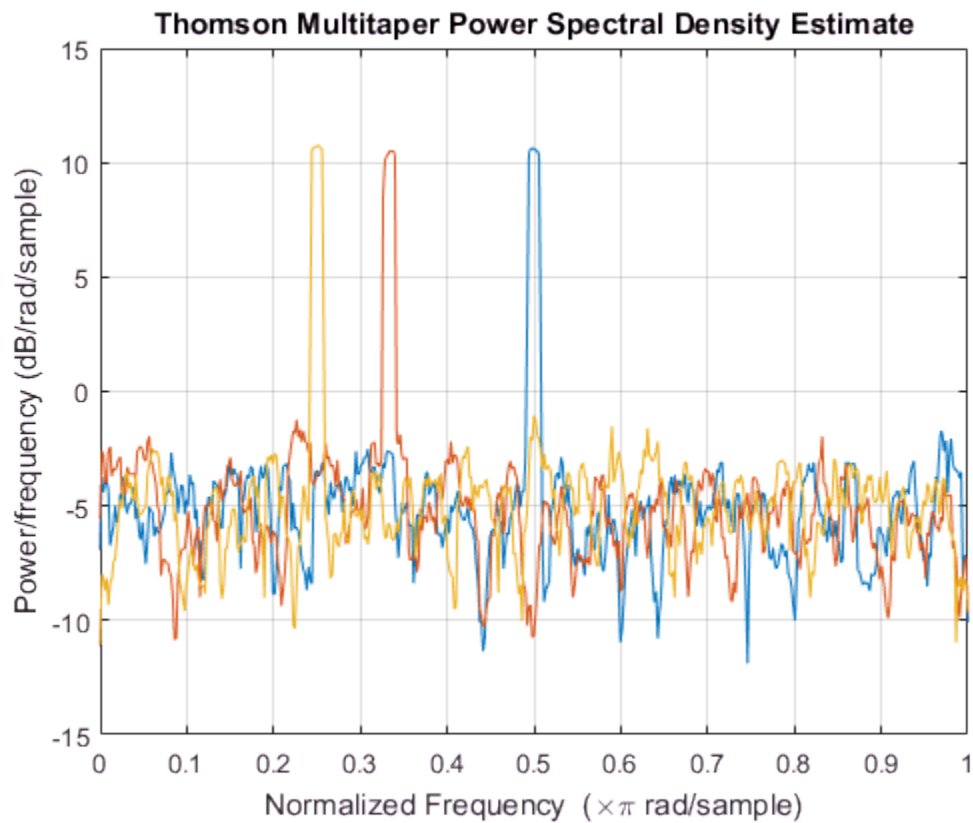

Input Arguments

x — Input signal
vector | matrix

Input signal, specified as a row or column vector, or as a matrix. If x is a matrix, then its columns are treated as independent channels.

Example: `cos(pi/4*(0:159))+randn(1,160)` is a single-channel row-vector signal.

Example: `cos(pi./[4;2]*(0:159))'+randn(160,2)` is a two-channel signal.

Data Types: `single` | `double`

Complex Number Support: Yes

nw — Time-halfbandwidth product

4 (default) | positive scalar

Time-halfbandwidth product, specified as a positive scalar. In multitaper spectral estimation, the user specifies the resolution bandwidth of the multitaper estimate $[-W, W]$ where $W = k/N\Delta t$ for some small $k > 1$. Equivalently, W is some small multiple of the frequency resolution of the DFT. The time-halfbandwidth product is the product of the resolution halfbandwidth and the number of samples in the input signal, N . The number of Slepian tapers whose Fourier transforms are well-concentrated in $[-W, W]$ (eigenvalues close to unity) is $2NW - 1$.

nfft — Number of DFT points

`max(256, 2^nextpow2(length(x)))` (default) | integer | []

Number of DFT points, specified as a positive integer. For a real-valued input signal, x , the PSD estimate, `pxx` has length $(nfft/2 + 1)$ if $nfft$ is even, and $(nfft + 1)/2$ if $nfft$ is odd. For a complex-valued input signal, x , the PSD estimate always has length $nfft$. If $nfft$ is specified as empty, the default $nfft$ is used.

Data Types: `single` | `double`

fs — Sample rate

positive scalar

Sample rate, specified as a positive scalar. The sample rate is the number of samples per unit time. If the unit of time is seconds, then the sample rate has units of Hz.

w — Normalized frequencies

vector

Normalized frequencies, specified as a row or column vector with at least two elements. Normalized frequencies are in rad/sample.

Example: `w = [pi/4 pi/2]`

Data Types: double

f — Frequencies

vector

Frequencies, specified as a row or column vector with at least two elements. The frequencies are in cycles per unit time. The unit time is specified by the sample rate, `fs`. If `fs` has units of samples/second, then `f` has units of Hz.

Example: `fs = 1000; f = [100 200]`

Data Types: double

method — Weights on individual tapered PSD estimates

'adapt' (default) | 'eigen' | 'unity'

Weights on individual tapered PSD estimates, specified as one of 'adapt', 'eigen', or 'unity'. The default is Thomson's adaptive frequency-dependent weights, 'adapt'. The calculation of these weights is detailed on pp. 368–370 in [1]. The 'eigen' method weights each tapered PSD estimate by the eigenvalue (frequency concentration) of the corresponding Slepian taper. The 'unity' method weights each tapered PSD estimate equally.

e — DPSS (Slepian) sequences

matrix

DPSS (Slepian) sequences, specified as a N-by-K matrix where N is the length of the input signal, `x`. The matrix `e` is the output of `dpss`.

v — Eigenvalues for DPSS (Slepian) sequences

vector

Eigenvalues for DPSS (Slepian) sequences, specified as a column vector. The eigenvalues for the DPSS sequences indicate the proportion of the sequence energy concentrated in the resolution bandwidth, $[-W, W]$. The eigenvalues range lie in the interval (0,1) and generally the first $2NW-1$ eigenvalues are close to 1 and then decrease toward 0.

dpss_params — Input arguments for dpss

cell array

Input arguments for `dpss`, specified as a cell array. The first input argument to `dpss` is the length of the DPSS sequences and is omitted from `dpss_params`. The length of the DPSS sequences is obtained from the length of the input signal, `x`.

Example: {3.5,5}

dropflag — Flag indicating whether to drop or keep the last DPSS sequence

true (default) | false

Flag indicating whether to drop or keep the last DPSS sequence, specified as a logical. The default is `true` and `pmtm` drops the last taper. In a multitaper estimate, the first $2NW - 1$ DPSS sequences have eigenvalues close to unity. If you use less than $2NW - 1$ sequences, it is likely that all the tapers have eigenvalues close to 1 and you can specify `dropflag` as `false` to keep the last taper.

freqrange — Frequency range for PSD estimate

'onesided' | 'twosided' | 'centered'

Frequency range for the PSD estimate, specified as a one of 'onesided', 'twosided', or 'centered'. The default is 'onesided' for real-valued signals and 'twosided' for complex-valued signals. The frequency ranges corresponding to each option are

- 'onesided' — returns the one-sided PSD estimate of a real-valued input signal, x . If `nfft` is even, `pxx` has length $nfft/2 + 1$ and is computed over the interval $[0, \pi]$ rad/sample. If `nfft` is odd, the length of `pxx` is $(nfft + 1)/2$ and the interval is $[0, \pi)$ rad/sample. When `fs` is optionally specified, the corresponding intervals are $[0, fs/2]$ cycles/unit time and $[0, fs/2)$ cycles/unit time for even and odd length `nfft` respectively.
- 'twosided' — returns the two-sided PSD estimate for either the real-valued or complex-valued input, x . In this case, `pxx` has length `nfft` and is computed over the interval $[0, 2\pi)$ rad/sample. When `fs` is optionally specified, the interval is $[0, fs)$ cycles/unit time.
- 'centered' — returns the centered two-sided PSD estimate for either the real-valued or complex-valued input, x . In this case, `pxx` has length `nfft` and is computed over the interval $(-\pi, \pi]$ rad/sample for even length `nfft` and $(-\pi, \pi)$ rad/sample for odd length `nfft`. When `fs` is optionally specified, the corresponding intervals are $(-fs/2, fs/2]$ cycles/unit time and $(-fs/2, fs/2)$ cycles/unit time for even and odd length `nfft` respectively.

Data Types: char

probability — Confidence interval for PSD estimate

0.95 (default) | scalar in the range (0,1)

Coverage probability for the true PSD, specified as a scalar in the range (0,1). The output, `pxxc`, contains the lower and upper bounds of the `probability × 100%` interval estimate for the true PSD.

Output Arguments

`pxx` — PSD estimate

vector | matrix

PSD estimate, returned as a real-valued, nonnegative column vector or matrix. Each column of `pxx` is the PSD estimate of the corresponding column of `x`. The units of the PSD estimate are in squared magnitude units of the time series data per unit frequency. For example, if the input data is in volts, the PSD estimate is in units of squared volts per unit frequency. For a time series in volts, if you assume a resistance of 1 Ω and specify the sample rate in hertz, the PSD estimate is in watts per hertz.

Data Types: `single` | `double`

`w` — Normalized frequencies

vector

Normalized frequencies, returned as a real-valued column vector. If `pxx` is a one-sided PSD estimate, `w` spans the interval $[0,\pi]$ if `nfft` is even and $[0,\pi)$ if `nfft` is odd. If `pxx` is a two-sided PSD estimate, `w` spans the interval $[0,2\pi)$. For a DC-centered PSD estimate, `w` spans the interval $(-\pi,\pi]$ for even `nfft` and $(-\pi,\pi)$ for odd `nfft`.

Data Types: `double`

`f` — Cyclical frequencies

vector

Cyclical frequencies, returned as a real-valued column vector. For a one-sided PSD estimate, `f` spans the interval $[0,fs/2]$ when `nfft` is even and $[0,fs/2)$ when `nfft` is odd. For a two-sided PSD estimate, `f` spans the interval $[0,fs)$. For a DC-centered PSD estimate, `f` spans the interval $(-fs/2, fs/2]$ cycles/unit time for even length `nfft` and $(-fs/2, fs/2)$ cycles/unit time for odd length `nfft`.

Data Types: `double`

`pxxc` — Confidence bounds

matrix

Confidence bounds, returned as a matrix with real-valued elements. The row size of the matrix is equal to the length of the PSD estimate, `pxx`. `pxxc` has twice as many columns as `pxx`. Odd-numbered columns contain the lower bounds of the confidence intervals, and even-numbered columns contain the upper bounds. Thus, `pxxc(m, 2*n-1)` is the lower confidence bound and `pxxc(m, 2*n)` is the upper confidence bound corresponding to the estimate `pxx(m, n)`. The coverage probability of the confidence intervals is determined by the value of the `probability` input.

Data Types: `single` | `double`

Definitions

Discrete Prolate Spheroidal (Slepian) Sequences

The derivation of the Slepian sequences proceeds from the discrete-time — continuous frequency concentration problem. For all ℓ^2 sequences index-limited to $0, 1, \dots, N-1$, the problem seeks the sequence having the maximal concentration of its energy in a frequency band $[-W, W]$ with $|W| < 1/2\Delta t$.

This amounts to finding the eigenvalues and corresponding eigenvectors of an N -by- N self-adjoint positive semi-definite operator. Therefore, the eigenvalues are real and nonnegative and eigenvectors corresponding to distinct eigenvalues are mutually orthogonal. In this particular problem, the eigenvalues are bounded by 1 and the eigenvalue is the measure of the sequence's energy concentration in the frequency interval $[-W, W]$.

The eigenvalue problem is given by

$$\sum_{n=0}^{N-1} \frac{\sin(2\pi W(n-m))}{\pi(n-m)} g_n = \lambda_k(N, W) g_m \quad m = 0, 1, 2, \dots, N-1$$

The 0th-order DPSS sequence, g_0 is the eigenvector corresponding to the largest eigenvalue. The 1-st order DPSS sequence, g_1 is the eigenvector corresponding to the next largest eigenvalue and is orthogonal to the 0-th order sequence. The 2nd-order DPSS sequence, g_2 , is the eigenvector corresponding to the third largest eigenvalue and is orthogonal to the 0-th order and 1-st order DPSS sequences. Because the operator is N -by- N , there are N eigenvectors. However, it can be shown that for a given sequence

length N and a specified bandwidth $[-W, W]$, there are approximately $2NW - 1$ DPSS sequences with eigenvalues very close to unity.

Multitaper Spectral Estimation

The periodogram is not a consistent estimator of the true power spectral density of a wide-sense stationary process. To produce a consistent estimate of the PSD, the multitaper method averages modified periodograms obtained using a family of mutually orthogonal tapers (windows). In addition to mutual orthogonality, the tapers also have optimal time-frequency concentration properties. Both the orthogonality and time-frequency concentration of the tapers is critical to the success of the multitaper technique. See “Discrete Prolate Spheroidal (Slepian) Sequences” on page 1-1551 for a brief description of the Slepian sequences used in Thomson’s multitaper method.

The multitaper method uses K modified periodograms with each one obtained using a different Slepian sequence as the window. Let

$$S_k(f) = \Delta t \left| \sum_{n=0}^{N-1} g_{k,n} x_n e^{-i2\pi f n \Delta t} \right|^2$$

denote the modified periodogram obtained with the k -th Slepian sequence, $g_{k,n}$.

In the simplest form, the multitaper method simply averages the K modified periodograms to produce the multitaper PSD estimate.

$$S^{(\text{MT})}(f) = \frac{1}{K} \sum_{k=0}^{K-1} S_k(f)$$

Note the difference between the multitaper PSD estimate and Welch’s method. Both methods reduce the variability in the periodogram by averaging over approximately uncorrelated estimates of the PSD. However, the two approaches differ in how they produce these uncorrelated PSD estimates. The multitaper method uses the entire signal in each modified periodogram. The orthogonality of the Slepian tapers decorrelates the different modified periodograms. Welch’s overlapped segment averaging approach uses segments of the signal in each modified periodogram and the segmenting decorrelates the different modified periodograms.

The preceding equation corresponds to the 'unity' option in `pmtm`. However, as explained in “Discrete Prolate Spheroidal (Slepian) Sequences” on page 1-1551, the

Slepian sequences do not possess equal energy concentration in the frequency band of interest. The higher the order of the Slepian sequence, the less concentrated the sequence energy is in the band $[-W, W]$ with the concentration given by the eigenvalue. Consequently, it can be beneficial to use the eigenvalues to weight the K modified periodograms prior to averaging. This corresponds to the 'eigen' option in pmtm.

Using the sequence eigenvalues to produce a weighted average of modified periodograms accounts for the frequency concentration properties of the Slepian sequences. However, it does not account for the interaction between the power spectral density of the random process and the frequency concentration of the Slepian sequences. Specifically, frequency regions where the random process has little power are less reliably estimated in the modified periodograms using higher order Slepian sequences. This argues for an frequency-dependent adaptive process, which accounts not only for the frequency concentration of the Slepian sequence, but also for the power distribution in the time series. This adaptive weighting corresponds to the 'adapt' option in pmtm and is the default for computing the multitaper estimate.

References

- [1] Percival, D. B., and A. T. Walden, *Spectral Analysis for Physical Applications: Multitaper and Conventional Univariate Techniques*. Cambridge, UK: Cambridge University Press, 1993.
- [2] Thomson, D. J., "Spectrum estimation and harmonic analysis." *Proceedings of the IEEE*. Vol.70, 1982, pp.1055–1096.

See Also

See Also

dpss | periodogram | pwelch

Introduced before R2006a

pmusic

Pseudospectrum using MUSIC algorithm

Syntax

```
[S,w] = pmusic(x,p)
[S,w] = pmusic(x,p,w)
[S,w] = pmusic(...,nfft)
[S,f] = pmusic(x,p,nfft,fs)
[S,f] = pmusic(x,p,f,fs)
[S,f] = pmusic(...,'corr')
[S,f] = pmusic(x,p,nfft,fs,nwin,overlap)
[...] = pmusic(...,freqrange)
[... ,v,e] = pmusic(...)
pmusic(...)
```

Description

`[S,w] = pmusic(x,p)` implements the MUSIC (Multiple Signal Classification) algorithm and returns **S**, the pseudospectrum estimate of the input signal **x**, and a vector **w** of normalized frequencies (in rad/sample) at which the pseudospectrum is evaluated. The pseudospectrum is calculated using estimates of the eigenvectors of a correlation matrix associated with the input data **x**, where **x** is specified as either:

- A row or column vector representing one observation of the signal
- A rectangular array for which each row of **x** represents a separate observation of the signal (for example, each row is one output of an array of sensors, as in array processing), such that $\mathbf{x}' * \mathbf{x}$ is an estimate of the correlation matrix

Note You can use the output of `corrmtx` to generate such an array **x**.

You can specify the second input argument **p** as either:

- A scalar integer. In this case, the signal subspace dimension is **p**.

- A two-element vector. In this case, $p(2)$, the second element of p , represents a threshold that is multiplied by λ_{\min} , the smallest estimated eigenvalue of the signal's correlation matrix. Eigenvalues below the threshold $\lambda_{\min} * p(2)$ are assigned to the noise subspace. In this case, $p(1)$ specifies the maximum dimension of the signal subspace.

Note: If the inputs to `pmusic` are real sinusoids, set the value of p to double the number of input signals. If the inputs are complex sinusoids, set p equal to the number of inputs.

The extra threshold parameter in the second entry in p provides you more flexibility and control in assigning the noise and signal subspaces.

S and w have the same length. In general, the length of the FFT and the values of the input x determine the length of the computed S and the range of the corresponding normalized frequencies. The following table indicates the length of S (and w) and the range of the corresponding normalized frequencies for this syntax.

S Characteristics for an FFT Length of 256 (Default)

Real/Complex Input Data	Length of S and w	Range of the Corresponding Normalized Frequencies
Real-valued	129	$[0, \pi]$
Complex-valued	256	$[0, 2\pi]$

$[S, w] = \text{pmusic}(x, p, w)$ returns the pseudospectrum in the vector S computed at the normalized frequencies specified in vector w , which has two or more elements

$[S, w] = \text{pmusic}(\dots, nfft)$ specifies the integer length of the FFT `nfft` used to estimate the pseudospectrum. The default value for `nfft` (entered as an empty vector `[]`) is 256.

The following table indicates the length of S and w , and the frequency range for w in this syntax.

S and Frequency Vector Characteristics

Real/Complex Input Data	nfft Even/Odd	Length of S and w	Range of w
Real-valued	Even	$(nfft/2 + 1)$	$[0, \pi]$

Real/Complex Input Data	nfft Even/Odd	Length of S and w	Range of w
Real-valued	Odd	$(nfft + 1) / 2$	$[0, \pi)$
Complex-valued	Even or odd	nfft	$[0, 2\pi)$

`[S, f] = pmusic(x, p, nfft, fs)` returns the pseudospectrum in the vector **S** evaluated at the corresponding vector of frequencies **f** (in Hz). You supply the sampling frequency **fs** in Hz. If you specify **fs** with the empty vector `[]`, the sampling frequency defaults to 1 Hz.

The frequency range for **f** depends on **nfft**, **fs**, and the values of the input **x**. The length of **S** (and **f**) is the same as in the **S** and Frequency Vector Characteristics above. The following table indicates the frequency range for **f** for this syntax.

S and Frequency Vector Characteristics with fs Specified

Real/Complex Input Data	nfft Even/Odd	Range of f
Real-valued	Even	$[0, fs/2]$
Real-valued	Odd	$[0, fs/2)$
Complex-valued	Even or odd	$[0, fs)$

`[S, f] = pmusic(x, p, f, fs)` returns the pseudospectrum in the vector **S** computed at the frequencies specified in vector **f**, which has two or more elements

`[S, f] = pmusic(..., 'corr')` forces the input argument **x** to be interpreted as a correlation matrix rather than matrix of signal data. For this syntax **x** must be a square matrix, and all of its eigenvalues must be nonnegative.

`[S, f] = pmusic(x, p, nfft, fs, nwin, noverlap)` allows you to specify **nwin**, a scalar integer indicating a rectangular window length, or a real-valued vector specifying window coefficients. Use the scalar integer **noverlap** in conjunction with **nwin** to specify the number of input sample points by which successive windows overlap. **noverlap** is not used if **x** is a matrix. The default value for **nwin** is $2 \times p(1)$ and **noverlap** is **nwin** - 1.

With this syntax, the input data **x** is segmented and windowed before the matrix used to estimate the correlation matrix eigenvalues is formulated. The segmentation of the data depends on **nwin**, **noverlap**, and the form of **x**. Comments on the resulting windowed segments are described in the following table.

Windowed Data Depending on x and nwin

Input data x	Form of $nwin$	Windowed Data
Data vector	Scalar	Length is $nwin$
Data vector	Vector of coefficients	Length is $length(nwin)$
Data matrix	Scalar	Data is not windowed.
Data matrix	Vector of coefficients	$length(nwin)$ must be the same as the column length of x , and $noverlap$ is not used.

See the Eigenvector Length Depending on Input Data and Syntax below for related information on this syntax.

Note The arguments $nwin$ and $noverlap$ are ignored when you include 'corr' in the syntax.

$[...] = pmusic(..., freqrange)$ specifies the range of frequency values to include in f or w . $freqrange$ can be either:

- 'half' — returns half the spectrum for a real input signal, x . If $nfft$ is even, then S has length $nfft/2 + 1$ and is computed over the interval $[0, \pi]$. If $nfft$ is odd, the length of S is $(nfft + 1)/2$ and the frequency interval is $[0, \pi]$. When you specify fs , the intervals are $[0, fs/2)$ and $[0, fs/2]$ for even and odd $nfft$, respectively.
- 'whole' — returns the whole spectrum for either real or complex input, x . In this case, S has length $nfft$ and is computed over the interval $[0, 2\pi]$. When you specify fs , the frequency interval is $[0, fs)$.
- 'centered' — returns the centered whole spectrum for either real or complex input, x . In this case, S has length $nfft$ and is computed over the interval $(-\pi, \pi]$ for even $nfft$ and $(-\pi, \pi)$ for odd $nfft$. When you specify fs , the frequency intervals are $(-fs/2, fs/2]$ and $(-fs/2, fs/2)$ for even and odd $nfft$, respectively.

Note You can put the arguments $freqrange$ or 'corr' anywhere in the input argument list after p .

$[..., v, e] = pmusic(...)$ returns the matrix v of noise eigenvectors, along with the associated eigenvalues in the vector e . The columns of v span the noise subspace of

dimension `size(v,2)`. The dimension of the signal subspace is `size(v,1) - size(v,2)`. For this syntax, `e` is a vector of estimated eigenvalues of the correlation matrix.

`pmusic(...)` with no output arguments plots the pseudospectrum in the current figure window.

Examples

pmusic with no Sampling Specified

This example analyzes a signal vector, `x`, assuming that two real sinusoidal components are present in the signal subspace. In this case, the dimension of the signal subspace is 4, because each real sinusoid is the sum of two complex exponentials.

```
n = 0:199;
x = cos(0.257*pi*n) + sin(0.2*pi*n) + 0.01*randn(size(n));
pmusic(x,4)      % Set p to 4 because there are two real inputs
```

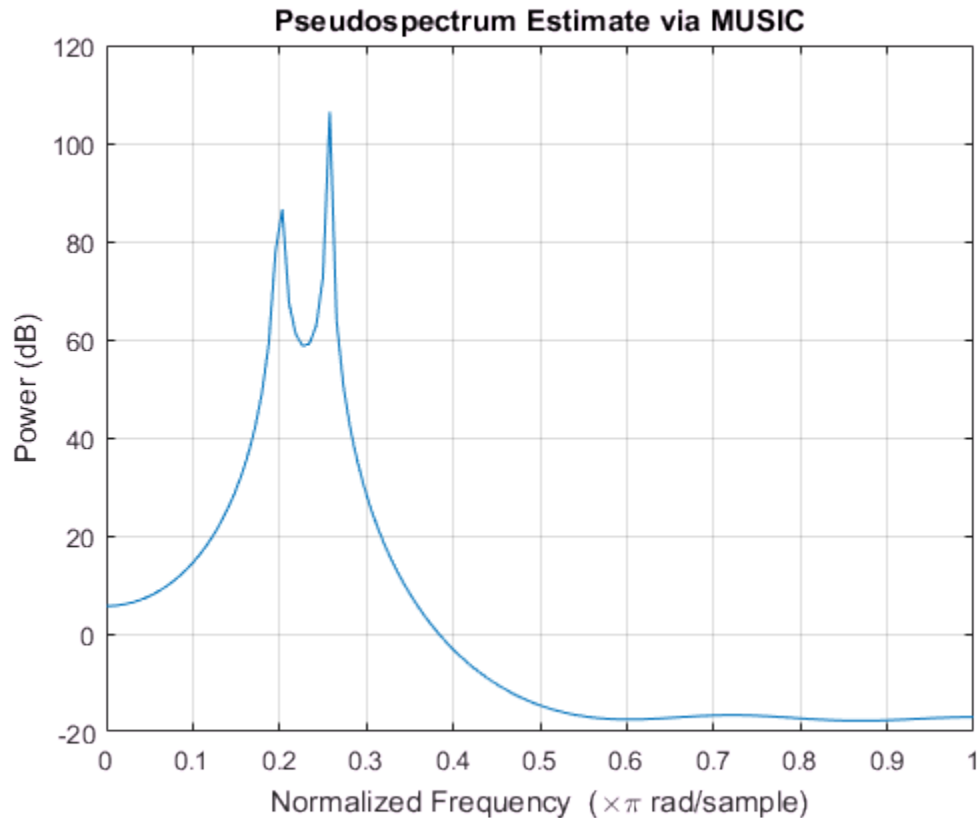

Specifying Sampling Frequency and Subspace Dimensions

This example analyzes the same signal vector, x , with an eigenvalue cutoff of 10% above the minimum. Setting $p(1) = \text{Inf}$ forces the signal/noise subspace decision to be based on the threshold parameter, $p(2)$. Specify the eigenvectors of length 7 using the `nwin` argument, and set the sampling frequency, `fs`, to 8 kHz:

```
rng default
n = 0:199;
x = cos(0.257*pi*n) + sin(0.2*pi*n) + 0.01*randn(size(n));
[P,f] = pmusic(x,[Inf,1.1],[],8000,7); % Window length = 7
plot(f,20*log10(abs(P)))
```

```
xlabel 'Frequency (Hz)', ylabel 'Power (dB)'
title 'Pseudospectrum Estimate via MUSIC', grid on
```

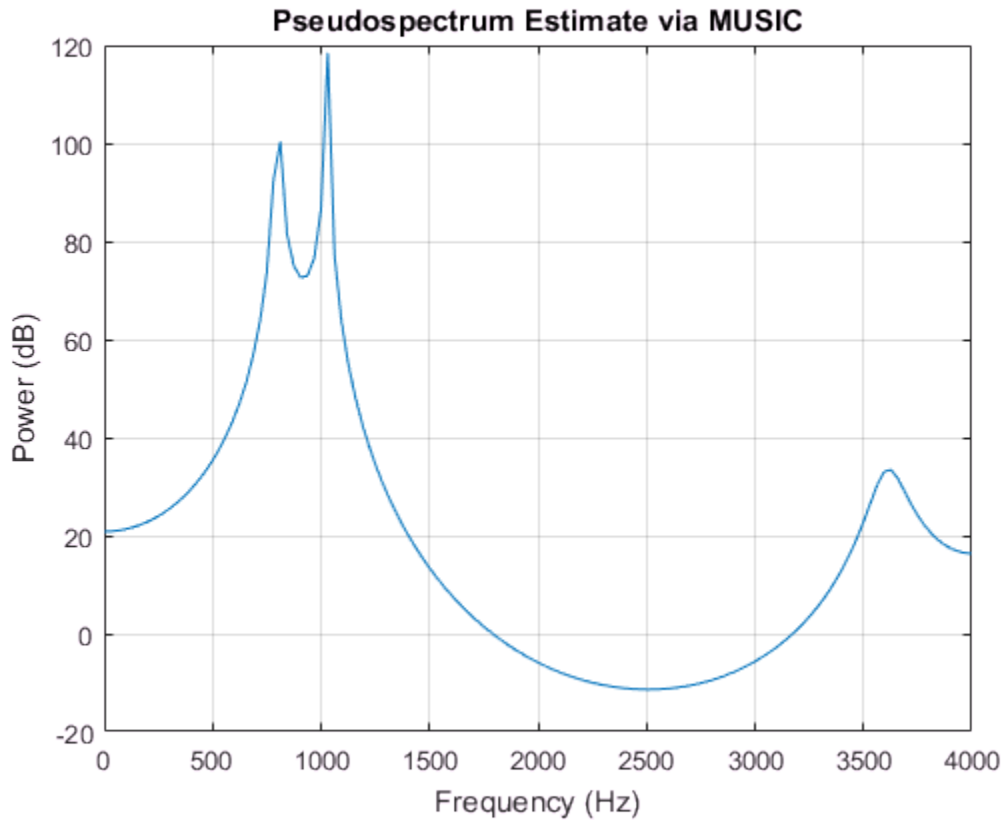

Entering a Correlation Matrix

Supply a positive definite correlation matrix, R , for estimating the spectral density. Use the default 256 samples.

```
R = toeplitz(cos(0.1*pi*(0:6))) + 0.1*eye(7);
pmusic(R,4,'corr')
```

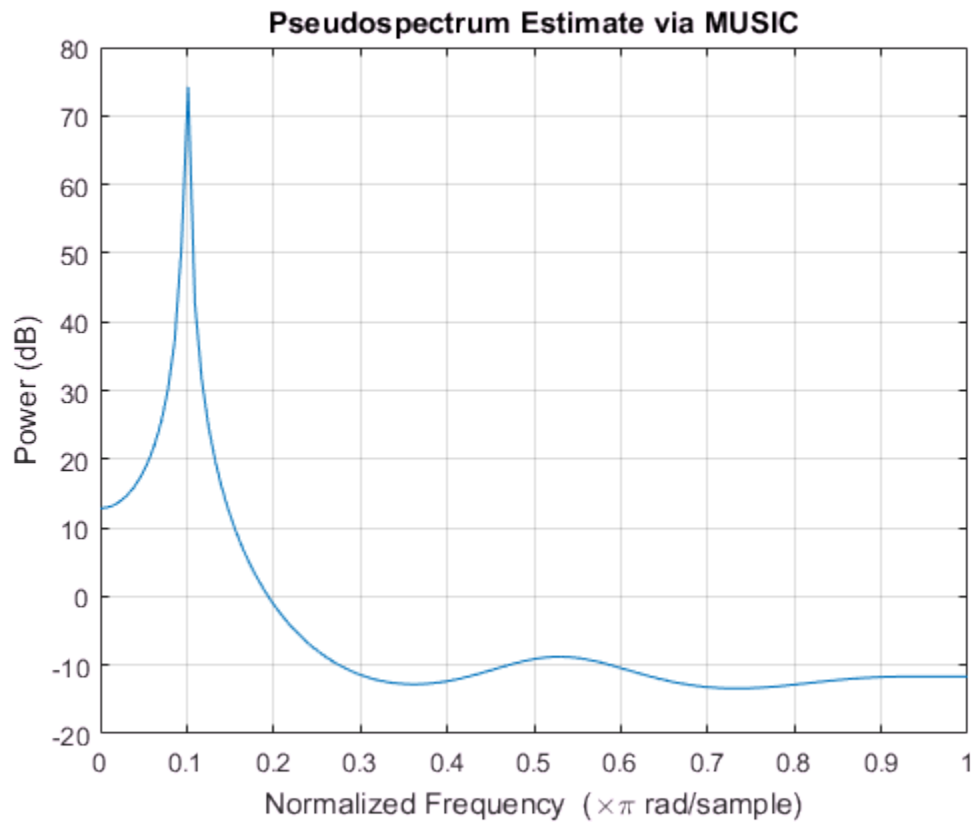

Entering a Signal Data Matrix Generated from corrmtx

Enter a signal data matrix, X_m , generated from data using `corrmtx`.

```
n = 0:699;  
x = cos(0.257*pi*(n)) + 0.1*randn(size(n));  
Xm = corrmtx(x,7,'mod');  
pmusic(Xm,2)
```

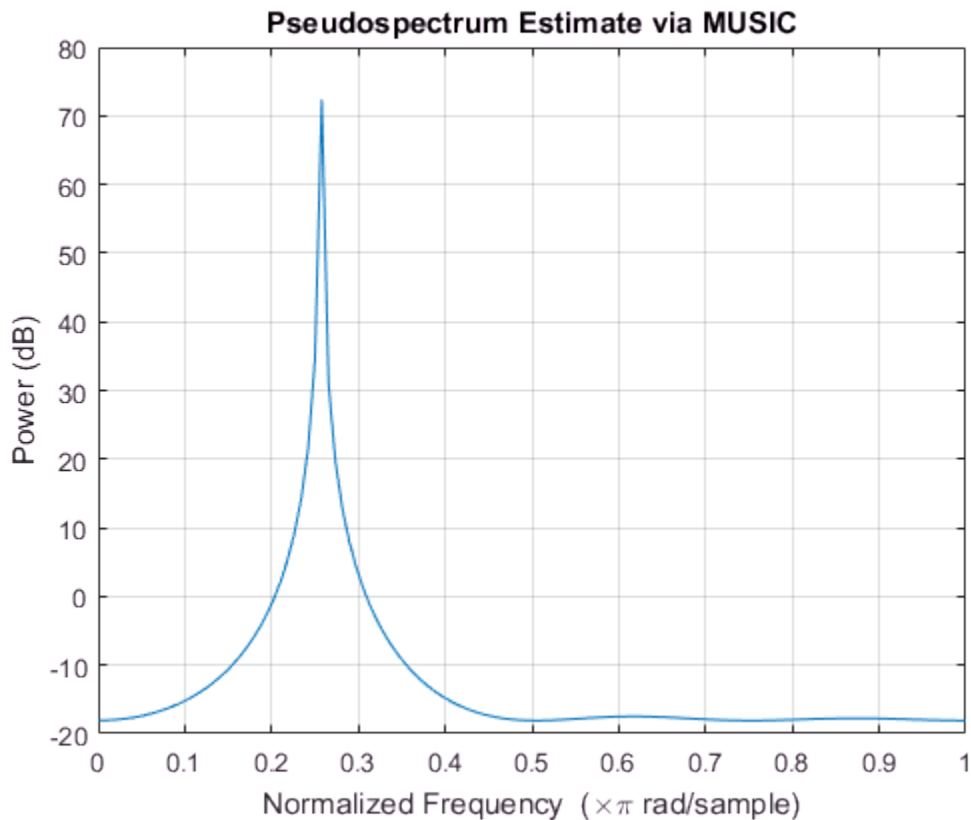

Using Windowing to Create the Effect of a Signal Data Matrix

Use the same signal, but let `pmusic` form the 100-by-7 data matrix using its windowing input arguments. In addition, specify an FFT of length 512.

```
n = 0:699;  
x = cos(0.257*pi*(n)) + 0.1*randn(size(n));  
[PP,ff] = pmusic(x,2,512,[],7,0);  
pmusic(x,2,512,[],7,0)
```

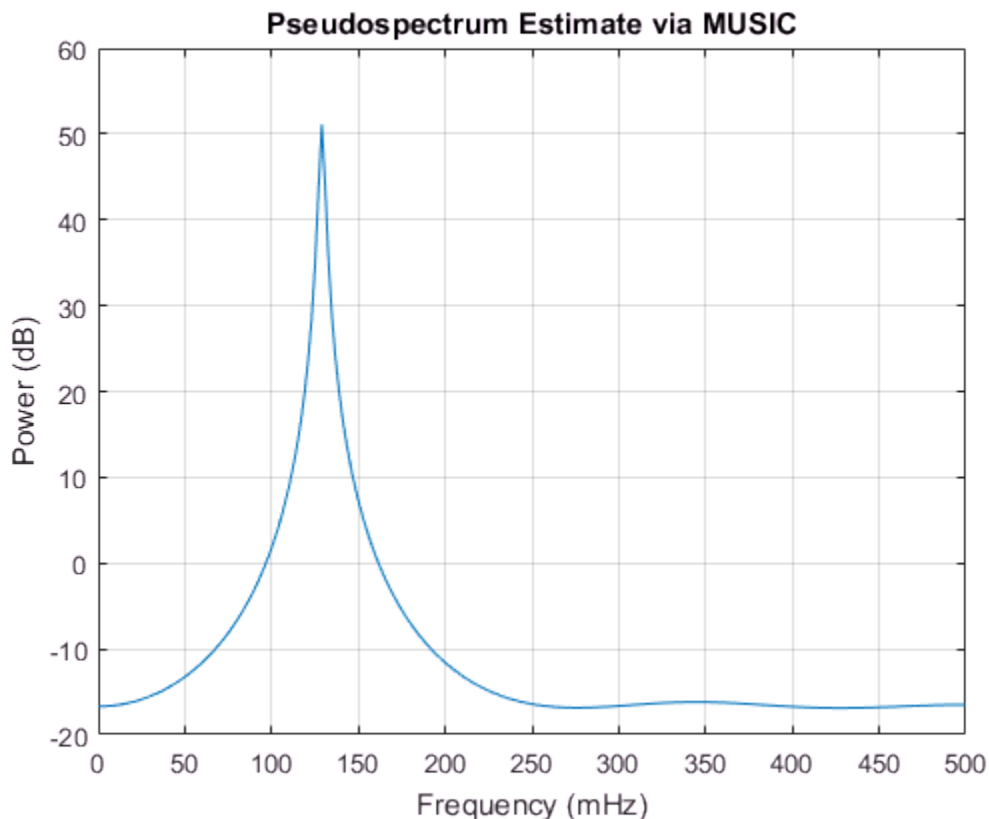
Tips

In the process of estimating the pseudospectrum, `pmusic` computes the noise and signal subspaces from the estimated eigenvectors v_j and eigenvalues λ_j of the signal's correlation matrix. The smallest of these eigenvalues is used in conjunction with the threshold parameter `p(2)` to affect the dimension of the noise subspace in some cases.

The length n of the eigenvectors computed by `pmusic` is the sum of the dimensions of the signal and noise subspaces. This eigenvector length depends on your input (signal data or correlation matrix) and the syntax you use.

The following table summarizes the dependency of the eigenvector length on the input argument.

Eigenvector Length Depending on Input Data and Syntax

Form of Input Data x	Comments on the Syntax	Length n of Eigenvectors
Row or column vector	$nwin$ is specified as a scalar integer.	$nwin$
Row or column vector	$nwin$ is specified as a vector.	$length(nwin)$
Row or column vector	$nwin$ is not specified.	$2 \times p(1)$
l -by- m matrix	If $nwin$ is specified as a scalar, it is not used. If $nwin$ is specified as a vector, $length(nwin)$ must equal m .	m
m -by- m nonnegative definite matrix	'corr' is specified and $nwin$ is not used.	m

You should specify $nwin > p(1)$ or $length(nwin) > p(1)$ if you want $p(2) > 1$ to have any effect.

Algorithms

The name MUSIC is an acronym for MULTiple SIGNAL Classification. The MUSIC algorithm estimates the pseudospectrum from a signal or a correlation matrix using Schmidt's eigenspace analysis method [1]. The algorithm performs eigenspace analysis of the signal's correlation matrix in order to estimate the signal's frequency content. This algorithm is particularly suitable for signals that are the sum of sinusoids with additive white Gaussian noise. The eigenvalues and eigenvectors of the signal's correlation matrix are estimated if you don't supply the correlation matrix.

The MUSIC pseudospectrum estimate is given by

$$P_{\text{MUSIC}}(f) = \frac{1}{e^H(f) \left(\sum_{k=p+1}^N v_k v_k^H \right) e(f)} = \frac{1}{\sum_{k=p+1}^N |v_k^H e(f)|^2}$$

where N is the dimension of the eigenvectors and \mathbf{v}_k is the k -th eigenvector of the correlation matrix. The integer p is the dimension of the signal subspace, so the eigenvectors \mathbf{v}_k used in the sum correspond to the smallest eigenvalues and also span the noise subspace. The vector $\mathbf{e}(f)$ consists of complex exponentials, so the inner product

$$\mathbf{v}_k^H \mathbf{e}(f)$$

amounts to a Fourier transform. This is used for computation of the pseudospectrum estimate. The FFT is computed for each \mathbf{v}_k and then the squared magnitudes are summed.

References

- [1] Marple, S. Lawrence. *Digital Spectral Analysis*. Englewood Cliffs, NJ: Prentice-Hall, 1987, pp.373–378.
- [2] Schmidt, R. O. “Multiple Emitter Location and Signal Parameter Estimation.” *IEEE Transactions on Antennas and Propagation*. Vol.AP-34, March, 1986, pp.276–280.
- [3] Stoica, Petre, and Randolph L. Moses. *Spectral Analysis of Signals*. Upper Saddle River, NJ: Prentice Hall, 2005.

See Also

corrmtx | pmtm | prony | pwelch | pburg | peig | periodogram | rooteig | rootmusic

Introduced before R2006a

poly2ac

Convert prediction filter polynomial to autocorrelation sequence

Syntax

```
r = poly2ac(a,efinal)
```

Description

`r = poly2ac(a,efinal)` returns the autocorrelation vector, `r`, corresponding to the autoregressive prediction filter polynomial, `a`, and the final prediction error, `efinal`. `r` is approximately equal to the autocorrelation of the output of a prediction filter with coefficients `a`. If `a(1)` is not equal to 1, `poly2ac` normalizes the prediction filter polynomial by `a(1)`. `a(1)` cannot be 0.

Examples

Autocorrelation Sequence from Prediction Filter

Given a prediction filter polynomial, `a`, and a final prediction error, `efinal`, find the autocorrelation sequence.

```
a = [1.0000 0.6147 0.9898 0.0004 0.0034 -0.0077];  
efinal = 0.2;  
r = poly2ac(a,efinal)
```

```
r =  
  
    5.5917  
   -1.7277  
   -4.4231  
    4.3985  
    1.6426  
   -5.3126
```

Tips

You can apply this function to both real and complex polynomials.

References

[1] Kay, Steven M. *Modern Spectral Estimation*. Englewood Cliffs, NJ: Prentice-Hall, 1988.

See Also

ac2poly | rc2ac | poly2rc

Introduced before R2006a

poly2lsf

Convert prediction filter coefficients to line spectral frequencies

Syntax

```
lsf = poly2lsf(a)
```

Description

`lsf = poly2lsf(a)` returns a vector, `lsf`, of line spectral frequencies from a vector, `a`, of prediction filter coefficients.

Examples

Generate Line Spectral Frequencies

Given a vector, `a`, of prediction filter coefficients, generate the corresponding line spectral frequencies.

```
a = [1.0000 0.6149 0.9899 0.0000 0.0031 -0.0082];
```

```
lsf = poly2lsf(a)
```

```
lsf =
```

```
0.7842
```

```
1.5605
```

```
1.8776
```

```
1.8984
```

```
2.3593
```

References

[1] Deller, John R., John G. Proakis, and John H. L. Hansen. *Discrete-Time Processing of Speech Signals*. New York: Macmillan, 1993.

[2] Rabiner, Lawrence R., and Ronald W. Schafer. *Digital Processing of Speech Signals*. Englewood Cliffs, NJ: Prentice-Hall, 1978.

See Also

lsf2poly

Introduced before R2006a

poly2rc

Convert prediction filter polynomial to reflection coefficients

Syntax

```
k = poly2rc(a)
[k,r0] = poly2rc(a,efinal)
```

Description

`k = poly2rc(a)` converts the prediction filter polynomial `a` to the reflection coefficients of the corresponding lattice structure. `a` can be real or complex, and `a(1)` cannot be 0. If `a(1)` is not equal to 1, `poly2rc` normalizes the prediction filter polynomial by `a(1)`. `k` is a row vector of size `length(a) - 1`.

`[k,r0] = poly2rc(a,efinal)` returns the zero-lag autocorrelation, `r0`, based on the final prediction error, `efinal`.

Examples

Find Reflection Coefficients from Prediction Filter Polynomial

Given a prediction filter polynomial, `a`, and a final prediction error, `efinal`, determine the reflection coefficients of the corresponding lattice structure and the zero-lag autocorrelation.

```
a = [1.0000 0.6149 0.9899 0.0000 0.0031 -0.0082];
efinal = 0.2;
[k,r0] = poly2rc(a,efinal)
```

```
k =
    0.3090
    0.9801
    0.0031
```



```
0.0081
-0.0082
```

```
r0 = 5.6032
```

Limitations

If $\text{abs}(k(i)) == 1$ for any i , finding the reflection coefficients is an ill-conditioned problem. `poly2rc` returns some NaNs and provides a warning message in those cases.

Tips

A simple, fast way to check if \mathbf{a} has all of its roots inside the unit circle is to check if each of the elements of \mathbf{k} has magnitude less than 1.

```
stable = all(abs(poly2rc(a))<1)
```

Algorithms

`poly2rc` implements this recursive relationship:

$$k(n) = a_n(n)$$

$$a_{n-1}(m) = \frac{a_n(m) - k(n)a_n(n-m)}{1 - k(n)^2}, \quad m = 1, 2, \dots, n-1$$

This relationship is based on Levinson's recursion [1]. To implement it, `poly2rc` loops through \mathbf{a} in reverse order after discarding its first element. For each loop iteration i , the function:

- 1 Sets $k(i)$ equal to $a(i)$
- 2 Applies the second relationship above to elements 1 through i of the vector \mathbf{a} .

```
a = (a-k(i)*fliplr(a))/(1-k(i)^2);
```

References

- [1] Kay, Steven M. *Modern Spectral Estimation*. Englewood Cliffs, NJ: Prentice-Hall, 1988.

See Also

`ac2rc` | `latc2tf` | `latcfilt` | `poly2ac` | `rc2poly` | `tf2latc`

Introduced before R2006a

polyscale

Scale roots of polynomial

Syntax

```
b = polyscale(a,alpha)
```

Description

`b = polyscale(a,alpha)` scales the roots of a polynomial in the z -plane, where `a` is a vector containing the polynomial coefficients and `alpha` is the scaling factor.

If `alpha` is a real value in the range `[0 1]`, then the roots of `a` are radially scaled toward the origin in the z -plane. Complex values for `alpha` allow arbitrary changes to the root locations.

Examples

Roots of Unity

Express the solutions to the equation $x^7 = 1$ as the roots of a polynomial. Plot the roots in the complex plane.

```
pp = [1 0 0 0 0 0 0 -1];  
zplane(pp,1)
```

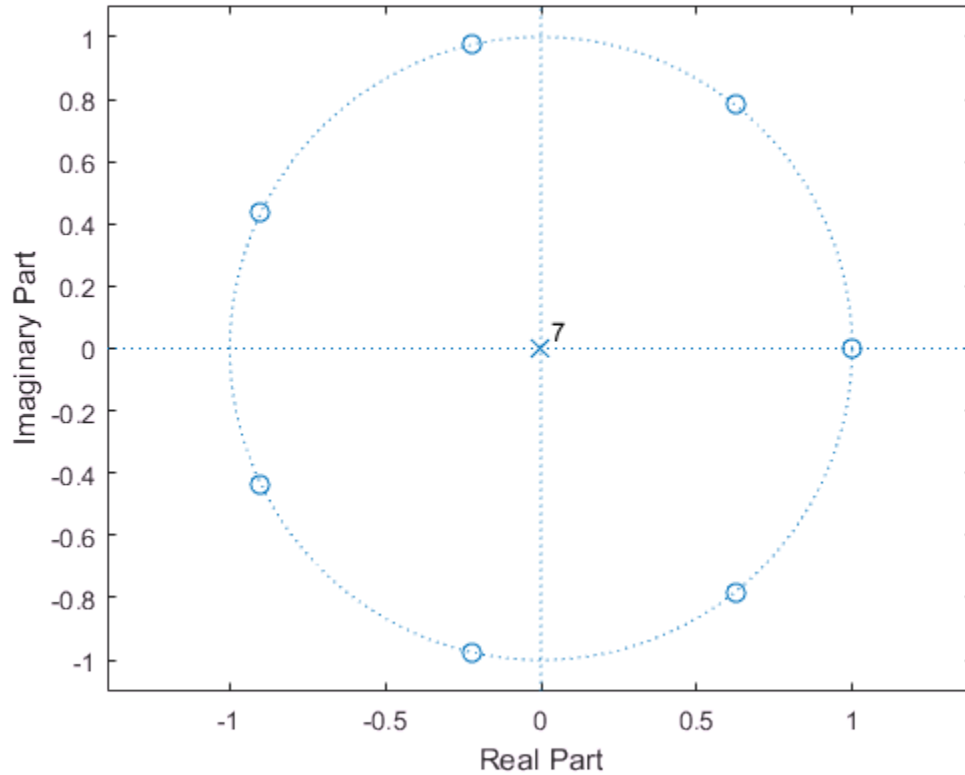

Scale the roots of p in and out of the unit circle. Plot the results.

```
hold on
for sc = [1:-0.2:0.2 1.2 1.4];
    b = polyscale(pp,sc);
    plot(roots(b), 'o')
end
axis([-1 1 -1 1]*1.5)
hold off
```

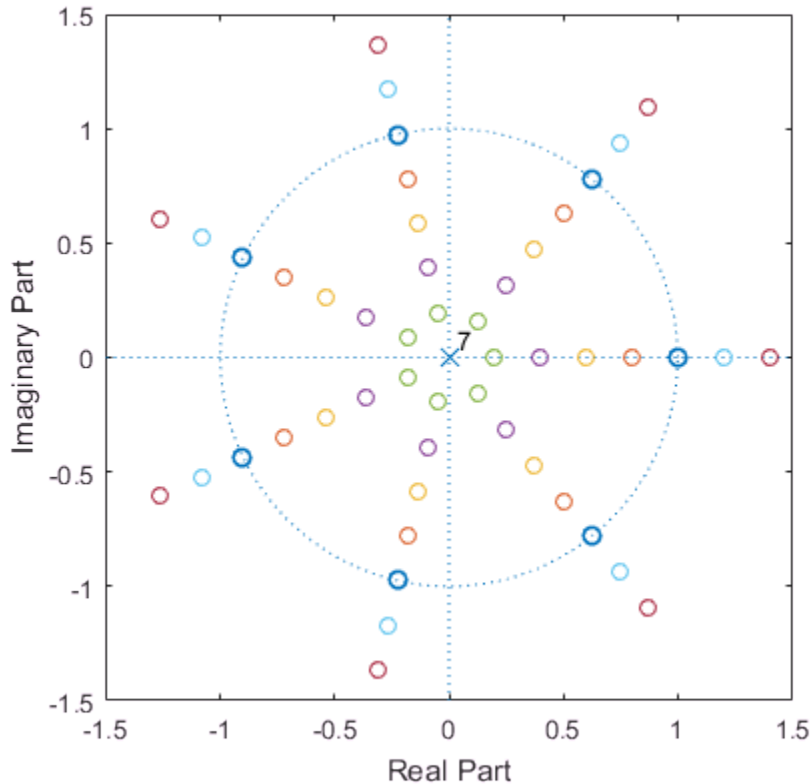

Bandwidth Expansion of LPC Speech Spectrum

Load a speech signal sampled at $F_s = 7418$ Hz. The file contains a recording of a female voice saying the word "MATLAB@."

```
load mtlb
```

Model a 100-sample section of the signal using a 12th-order autoregressive polynomial.

```
Ao = lpc(mtlb(1000:1100),12);
Ax = polyscale(Ao,0.85);
```

Perform bandwidth expansion of the signal by scaling the roots of the autoregressive polynomial by 0.85. Plot the zeros, poles, and frequency responses of the models.

```
subplot(2,2,1)
zplane(1,Ao)
title('Original')

subplot(2,2,3)
zplane(1,Ax)
title('Flattened')

subplot(1,2,2)
[ho,w] = freqz(1,Ao);
[hx,w] = freqz(1,Ax);
plot(w/pi,abs([ho hx]))
legend('Original','Flattened')
```

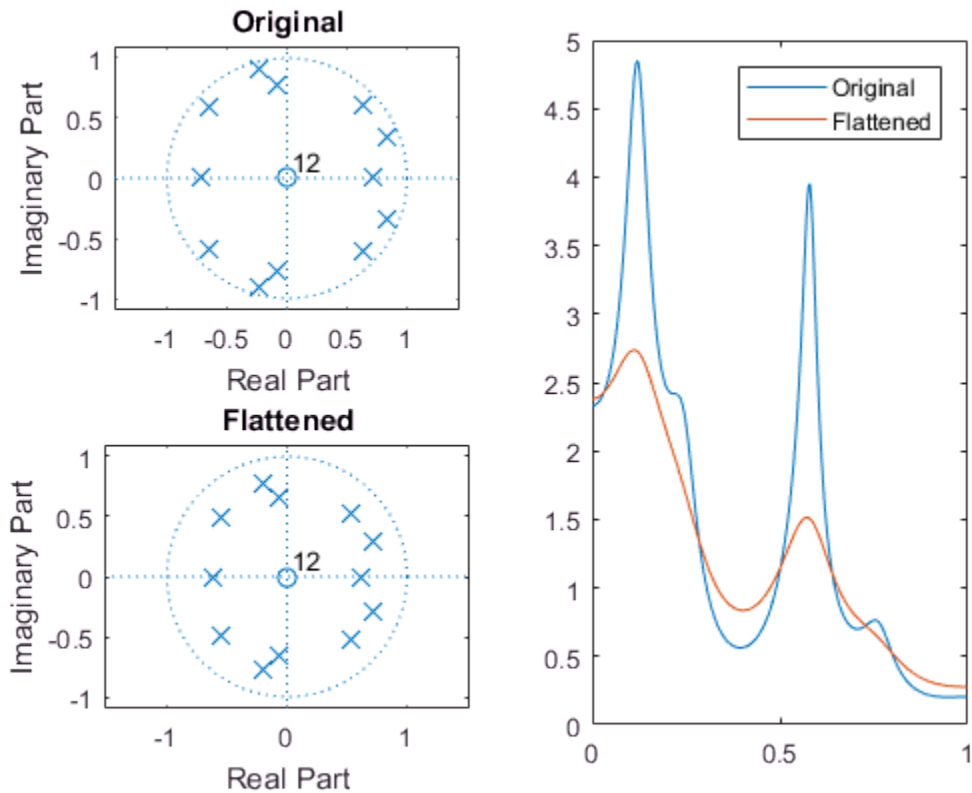

Tips

By reducing the radius of the roots in an autoregressive polynomial, the bandwidth of the spectral peaks in the frequency response is expanded (flattened). This operation is often referred to as *bandwidth expansion*.

See Also

polystab | roots

Introduced before R2006a

polystab

Stabilize polynomial

Syntax

```
b = polystab(a)
```

Description

`polystab` stabilizes a polynomial with respect to the unit circle; it reflects roots with magnitudes greater than 1 inside the unit circle.

`b = polystab(a)` returns a row vector **b** containing the stabilized polynomial. **a** is a vector of polynomial coefficients, normally in the z -domain:

$$A(z) = a(1) + a(2)z^{-1} + \dots + a(m+1)z^{-m}.$$

Examples

Convert Linear-Phase Filter to Minimum-Phase

Use the window method to design a 25th-order FIR filter with normalized cutoff frequency 0.4π rad/sample. Verify that it has linear phase but not minimum phase.

```
h = fir1(25,0.4);  
h_linphase = islinphase(h)  
h_linphase = logical  
1  
  
h_minphase = isminphase(h)
```

```
h_minphase = logical  
0
```

Use `polystab` to convert the linear-phase filter into a minimum-phase filter. Plot the phase responses of the filters.

```
hmin = polystab(h)*norm(h)/norm(polystab(h));
```

```
hmin_linphase = islinphase(hmin)
```

```
hmin_linphase = logical  
0
```

```
hmin_minphase = isminphase(hmin)
```

```
hmin_minphase = logical  
1
```

```
hfvt = fvtool(h,1,hmin,1,'Analysis','phase');  
legend(hfvt,'h','hmin')
```

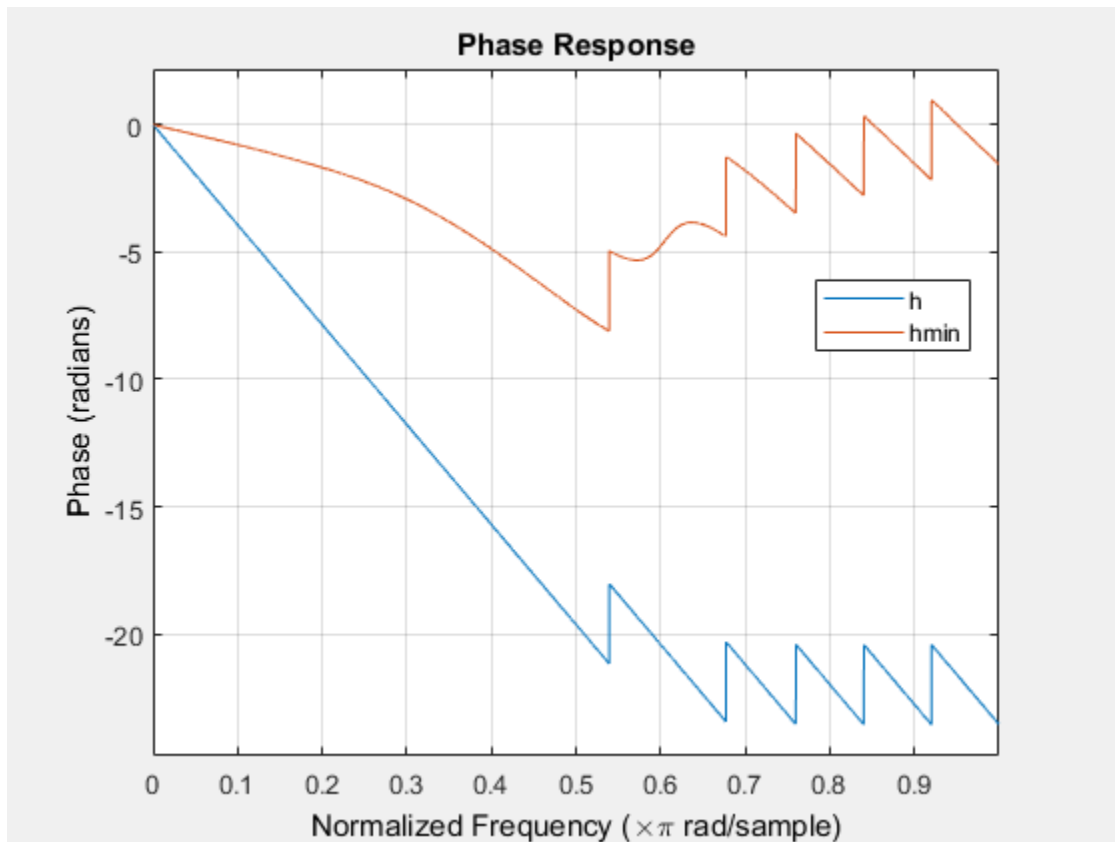

Verify that the two filters have identical magnitude responses.

```
hfvt = fvtool(h,1,hmin,1);  
legend(hfvt,'h','hmin')
```

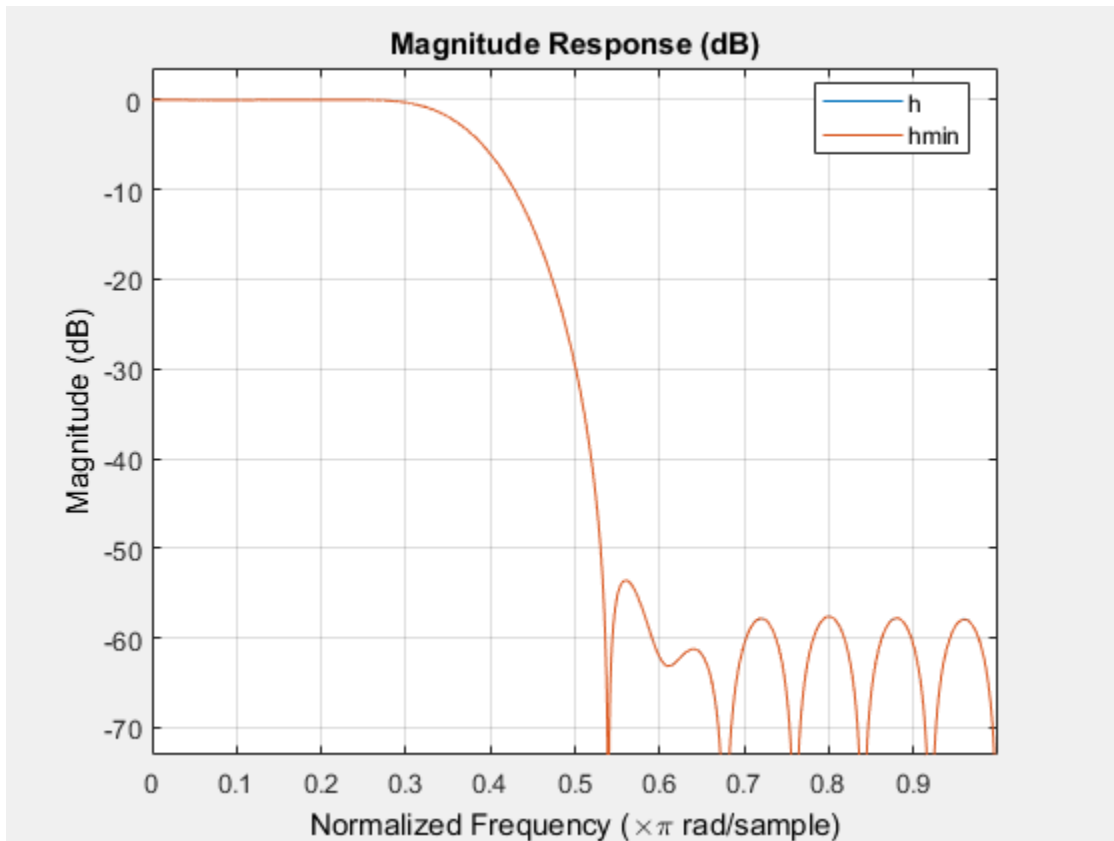

Algorithms

`polystab` finds the roots of the polynomial and maps those roots found outside the unit circle to the inside of the unit circle:

```
v = roots(a);  
vs = 0.5*(sign(abs(v)-1)+1);  
v = (1-vs).*v + vs./conj(v);  
b = a(1)*poly(v);
```

See Also

roots

Introduced before R2006a

pow2db

Convert power to decibels

Syntax

```
ydb = pow2db(y)
```

Description

`ydb = pow2db(y)` expresses in decibels (dB) the power measurements specified in `y`. The relationship between power and decibels is $ydb = 10 \log_{10}(y)$.

Examples

Power Spectrum of a Noisy Sinusoid

Generate 1024 samples of a noisy sinusoid having a normalized frequency of $2\pi/3$ rad/sample. Estimate the power spectrum of the signal using `pwelch`. Express the estimate in decibels and plot it.

```
n = 0:1024-1;  
x = cos(2*pi*n/3) + randn(size(n));  
  
[pxx,w] = pwelch(x, 'power');  
  
dB = pow2db(pxx);  
  
plot(w/pi, dB)  
xlabel('\omega / \pi')  
ylabel('Power (dB)')
```

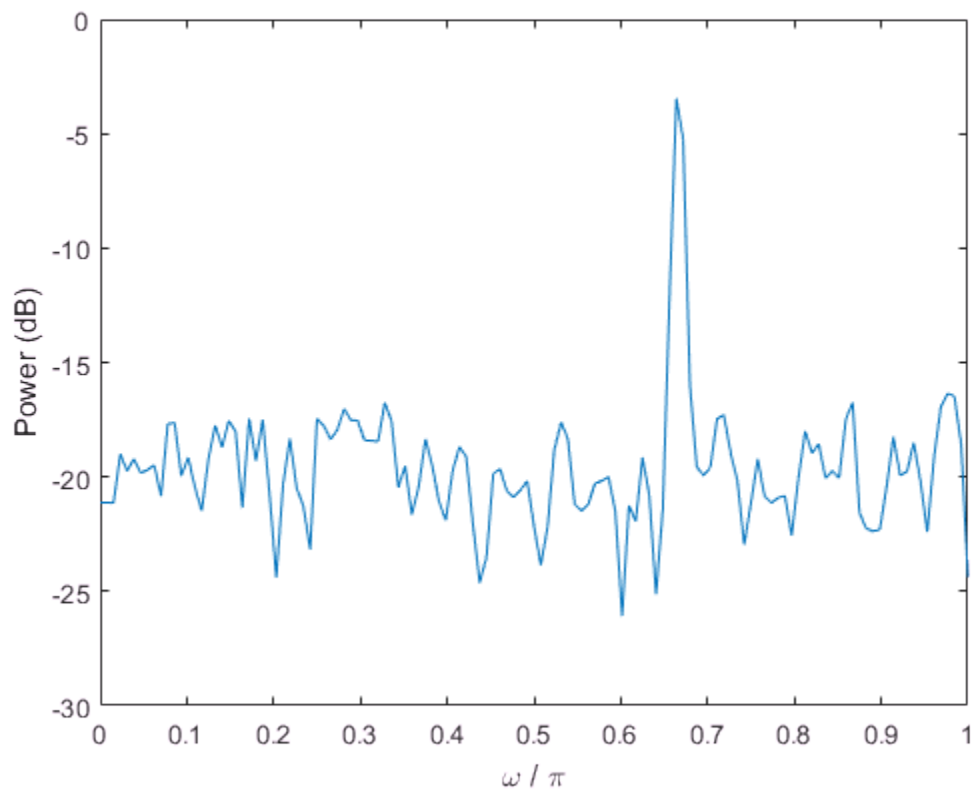

Repeat the computation using `pwelch` without output arguments.

```
pwelch(x, 'power')
```

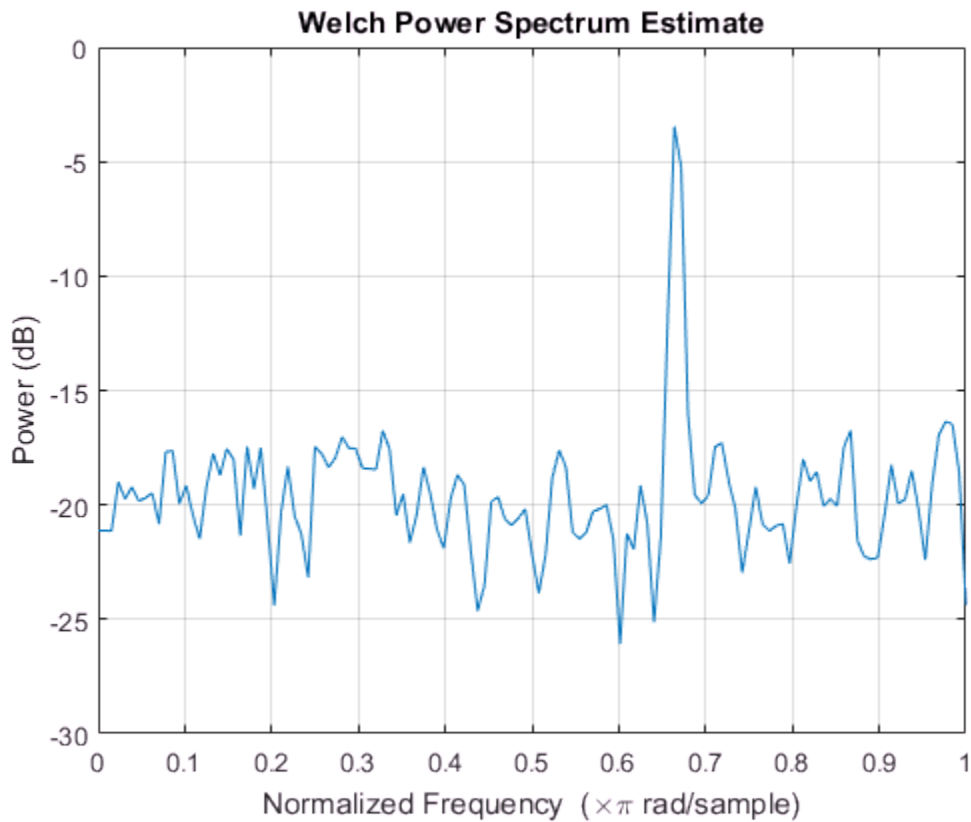

Input Arguments

y — Input array

scalar | vector | matrix | N-D array

Input array, specified as a scalar, vector, matrix, or N-D array. When **y** is nonscalar, `pow2db` is an element-wise operation.

Data Types: `single` | `double`

Output Arguments

ydb — Power measurements in decibels

scalar | vector | matrix | N-D array

Power measurements in decibels, returned as a scalar, vector, matrix, or N-D array of the same size as *y*.

Extended Capabilities

C/C++ Code Generation

Generate C and C++ code using MATLAB® Coder™.

See Also

See Also

db | db2mag | db2pow | mag2db

Introduced in R2007b

powerbw

Power bandwidth

Syntax

```
bw = powerbw(x)
bw = powerbw(x, fs)

bw = powerbw(pxx, f)
bw = powerbw(sxx, f, rbw)

bw = powerbw( ____, freqrange, r)

[bw, flo, fhi, power] = powerbw( ____)

powerbw( ____)
```

Description

`bw = powerbw(x)` returns the 3-dB (half-power) bandwidth, `bw`, of the input signal, `x`.

`bw = powerbw(x, fs)` returns the 3-dB bandwidth in terms of the sample rate, `fs`.

`bw = powerbw(pxx, f)` returns the 3-dB bandwidth of the power spectral density (PSD) estimate, `pxx`. The frequencies, `f`, correspond to the estimates in `pxx`.

`bw = powerbw(sxx, f, rbw)` computes the 3-dB bandwidth of the power spectrum estimate, `sxx`. The frequencies, `f`, correspond to the estimates in `sxx`. `rbw` is the resolution bandwidth used to integrate each power estimate.

`bw = powerbw(____, freqrange, r)` specifies the frequency interval over which to compute the reference level, using any of the input arguments from previous syntaxes. `freqrange` must lie within the target band.

If you also specify `r`, the function computes the difference in frequency between the points where the spectrum drops below the reference level by `r` dB or reaches an endpoint.

`[bw, flo, fhi, power] = powerbw(___)` also returns the lower and upper bounds of the power bandwidth and the power within those bounds.

`powerbw(___)` with no output arguments plots the PSD or power spectrum in the current figure window and annotates the bandwidth.

Examples

3-dB Bandwidth of Chirps

Generate 1024 samples of a chirp sampled at 1024 kHz. The chirp has an initial frequency of 50 kHz and reaches 100 kHz at the end of the sampling. Add white Gaussian noise such that the signal-to-noise ratio is 40 dB. Reset the random number generator for reproducible results.

```
nSamp = 1024;  
Fs = 1024e3;  
SNR = 40;  
rng default  
  
t = (0:nSamp-1)'/Fs;  
  
x = chirp(t,50e3,nSamp/Fs,100e3);  
x = x+randn(size(x))*std(x)/db2mag(SNR);
```

Estimate the 3-dB bandwidth of the signal and annotate it on a plot of the power spectral density (PSD).

```
powerbw(x,Fs)  
  
ans = 4.4386e+04
```

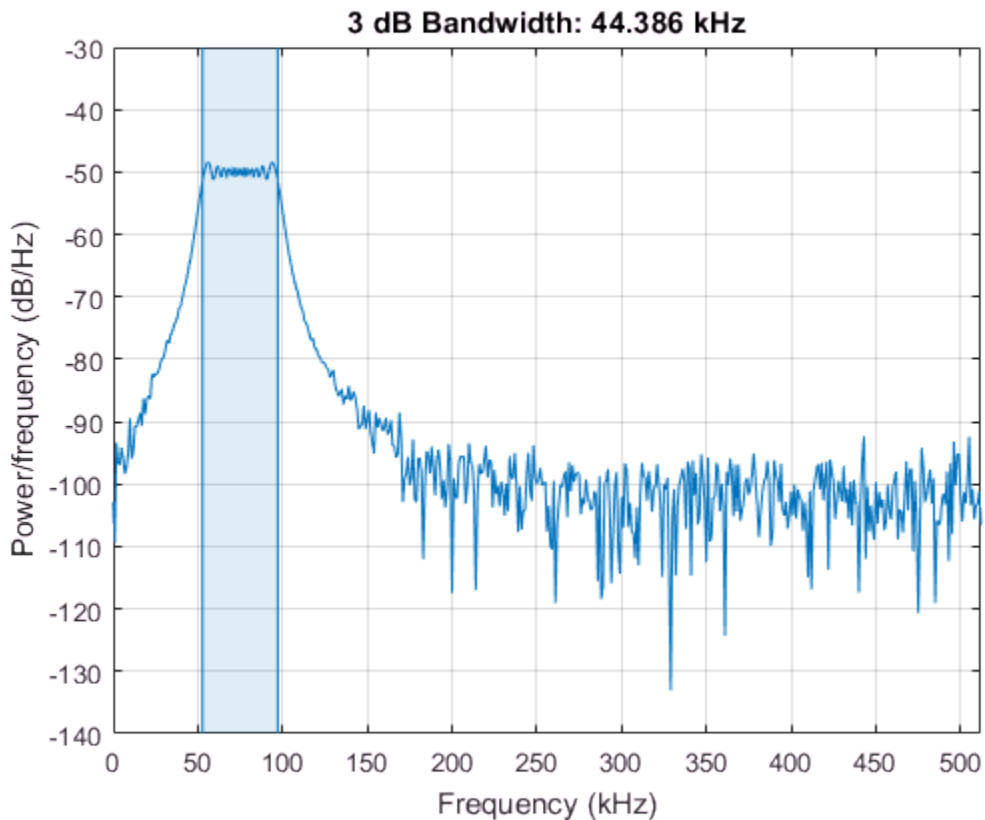

Generate another chirp. Specify an initial frequency of 200 kHz, a final frequency of 300 kHz, and an amplitude that is twice that of the first signal. Add white Gaussian noise.

```
x2 = 2*chirp(t,200e3,nSamp/Fs,300e3);
x2 = x2+randn(size(x2))*std(x2)/db2mag(SNR);
```

Concatenate the chirps to produce a two-channel signal. Estimate the 3-dB bandwidth of each channel.

```
y = powerbw([x x2],Fs)
```

```
y =
```

```
1.0e+04 *
```

4.4386 9.2208

Annotate the 3-dB bandwidths of the two channels on a plot of the PSDs.

```
powerbw([x x2],Fs);
```

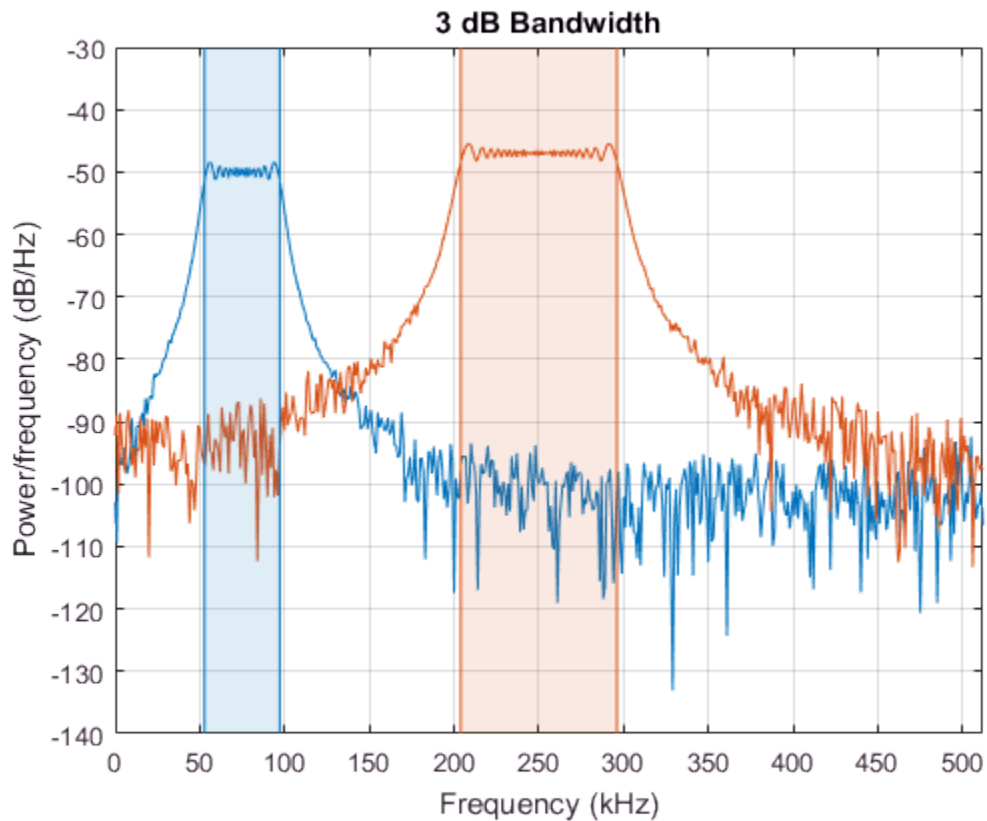

Add the two channels to form a new signal. Plot the PSD and annotate the 3-dB bandwidth.

```
powerbw(x+x2,Fs)
```

```
ans = 9.2243e+04
```

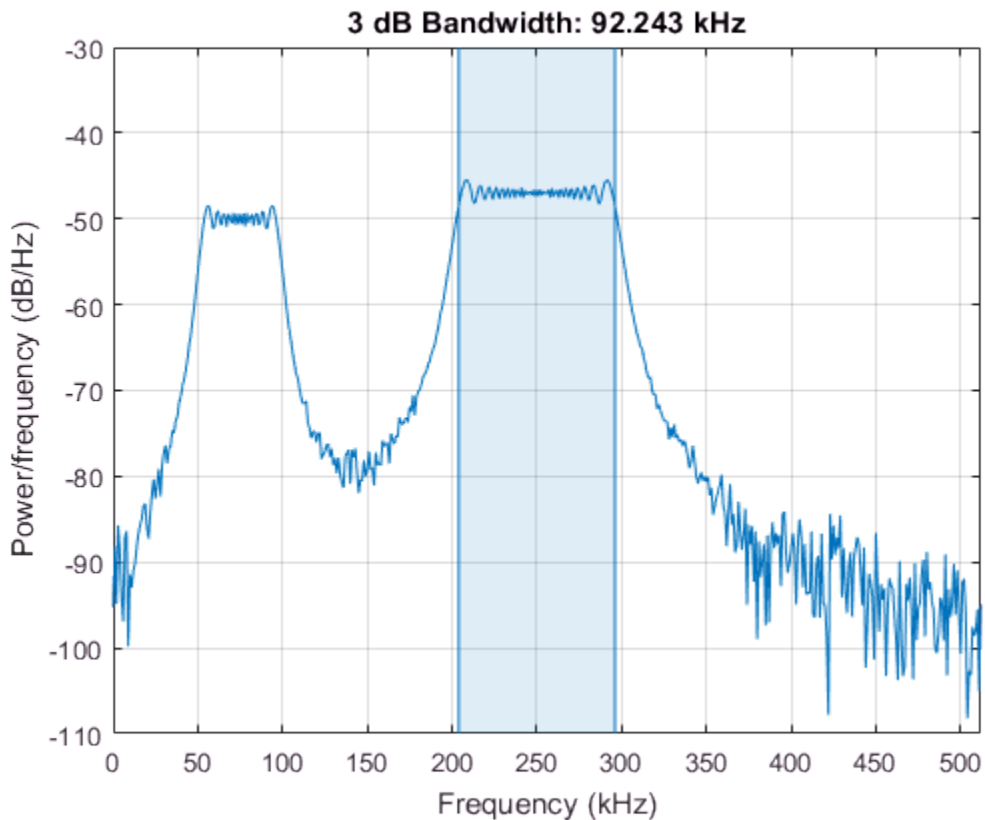

3-dB Bandwidth of Sinusoids

Generate 1024 samples of a 100.123 kHz sinusoid sampled at 1024 kHz. Add white Gaussian noise such that the signal-to-noise ratio is 40 dB. Reset the random number generator for reproducible results.

```
nSamp = 1024;  
Fs = 1024e3;  
SNR = 40;  
rng default
```

```
t = (0:nSamp-1)'/Fs;
```

```
x = sin(2*pi*t*100.123e3);
x = x + randn(size(x))*std(x)/db2mag(SNR);
```

Use the `periodogram` function to compute the power spectral density (PSD) of the signal. Specify a Kaiser window with the same length as the signal and a shape factor of 38. Estimate the 3-dB bandwidth of the signal and annotate it on a plot of the PSD.

```
[Pxx,f] = periodogram(x,kaiser(nSamp,38),[],Fs);
powerbw(Pxx,f);
```

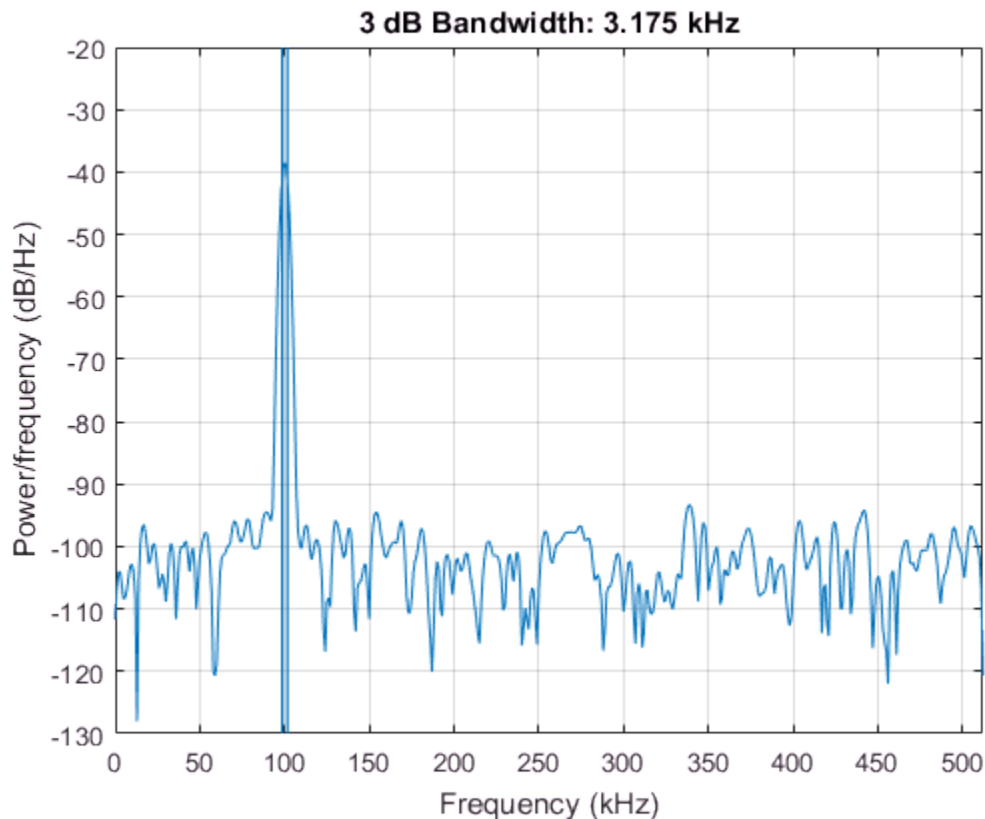

Generate another sinusoid, this one with a frequency of 257.321 kHz and an amplitude that is twice that of the first sinusoid. Add white Gaussian noise.

```
x2 = 2*sin(2*pi*t*257.321e3);  
x2 = x2 + randn(size(x2))*std(x2)/db2mag(SNR);
```

Concatenate the sinusoids to produce a two-channel signal. Estimate the PSD of each channel and use the result to determine the 3-dB bandwidth.

```
[Pyy,f] = periodogram([x x2],kaiser(nSamp,38),[],Fs);
```

```
y = powerbw(Pyy,f)
```

```
y =
```

```
1.0e+03 *  
3.1753    3.3015
```

Annotate the 3-dB bandwidths of the two channels on a plot of the PSDs.

```
powerbw(Pyy,f);
```

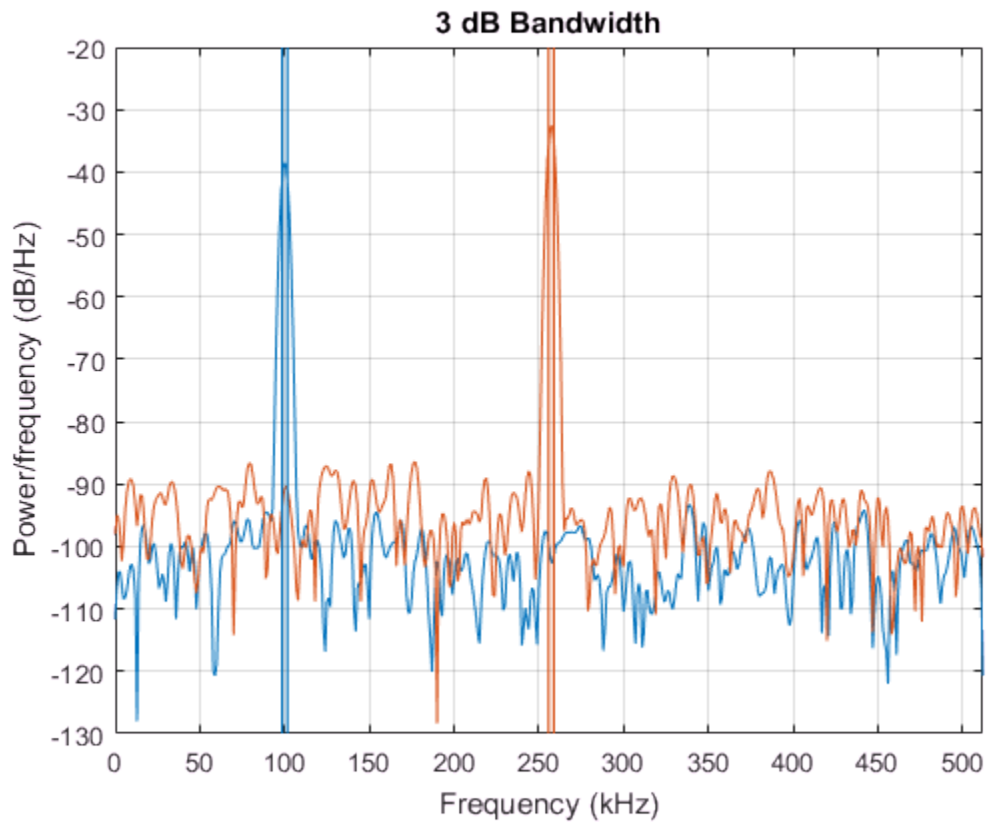
Add the two channels to form a new signal. Estimate the PSD and annotate the 3-dB bandwidth.

```
[Pzz,f] = periodogram(x+x2,kaiser(nSamp,38),[],Fs);
```

```
powerbw(Pzz,f);
```

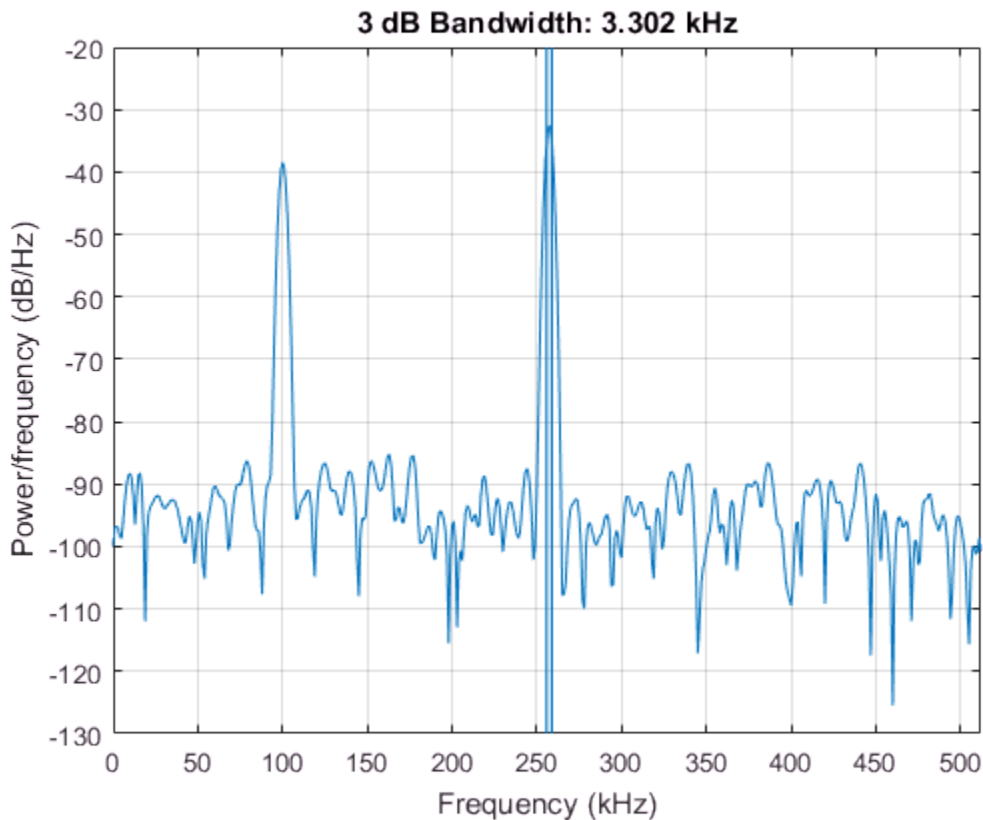

Bandwidth of Bandlimited Signals

Generate a signal whose PSD resembles the frequency response of an 88th-order bandpass FIR filter with normalized cutoff frequencies 0.25π rad/sample and 0.45π rad/sample.

```
d = fir1(88,[0.25 0.45]);
```

Compute the 3-dB occupied bandwidth of the signal. Specify as a reference level the average power in the band between 0.2π rad/sample and 0.6π rad/sample. Plot the PSD and annotate the bandwidth.

```
powerbw(d,[],[0.2 0.6]*pi,3);
```

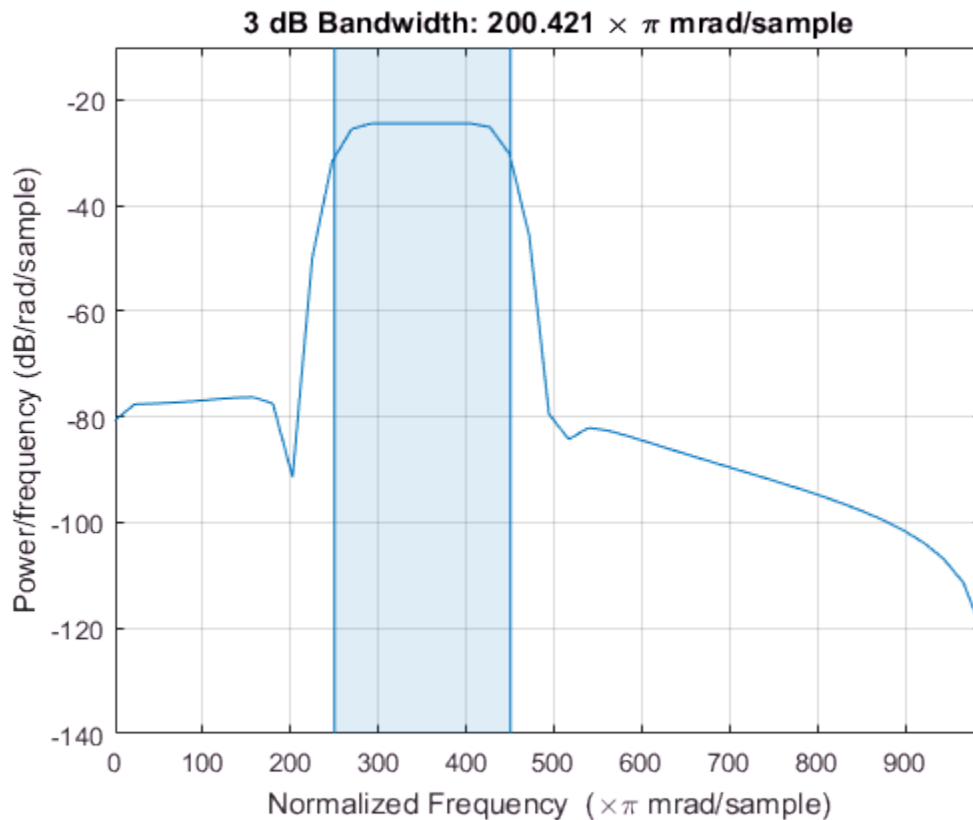

Output the bandwidth, its lower and upper bounds, and the band power. Specifying a sample rate of 2π is equivalent to leaving the rate unset.

```
[bw,flo,fhi,power] = powerbw(d,2*pi,[0.2 0.6]*pi);
fprintf('bw = %.3f*pi, flo = %.3f*pi, fhi = %.3f*pi \n', ...
        [bw flo fhi]/pi)
bw = 0.200*pi, flo = 0.250*pi, fhi = 0.450*pi
fprintf('power = %.1f%% of total',power/bandpower(d)*100)
```

```
power = 96.9% of total
```

Add a second channel with normalized cutoff frequencies 0.5π rad/sample and 0.8π rad/sample and an amplitude that is one-tenth that of the first channel.

```
d = [d;fir1(88,[0.5 0.8])/10]';
```

Compute the 6-dB bandwidth of the two-channel signal. Specify as a reference level the maximum power level of the spectrum.

```
powerbw(d,[],[],6);
```

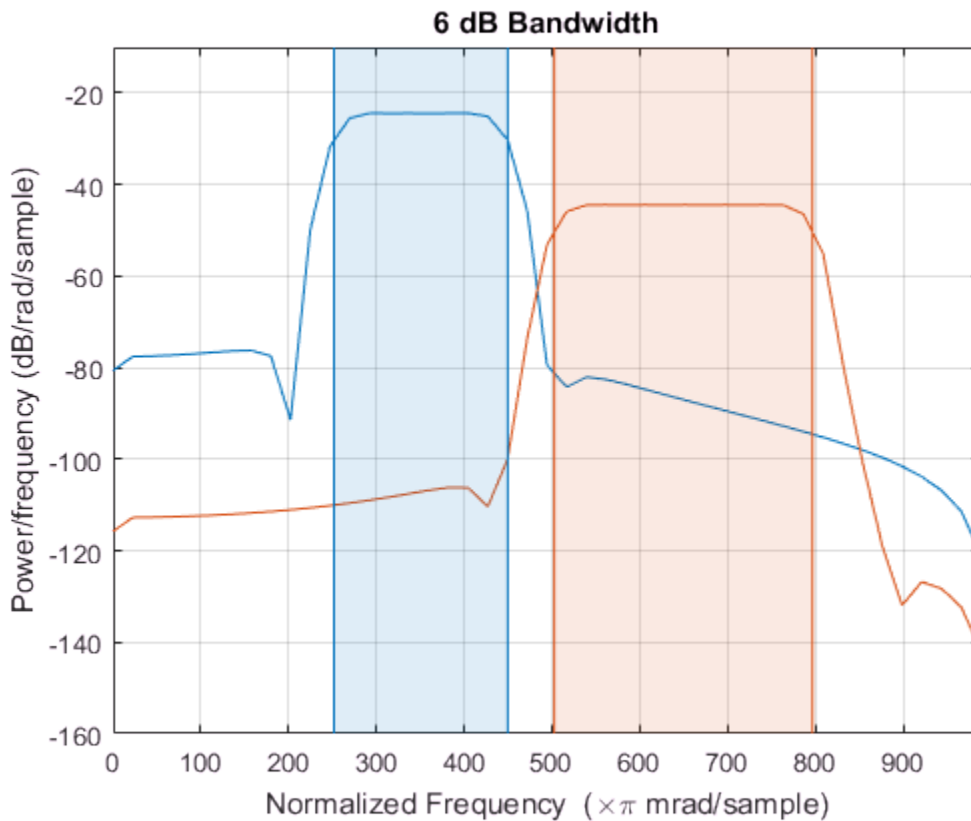

Output the 6-dB bandwidth of each channel and the lower and upper bounds.

```
[bw,flo,fhi] = powerbw(d,[],[],6);
bds = [bw;flo;fhi];

fprintf('One: bw = %.3f*pi, flo = %.3f*pi, fhi = %.3f*pi \n',bds(:,1)/pi)
One: bw = 0.198*pi, flo = 0.252*pi, fhi = 0.450*pi
fprintf('Two: bw = %.3f*pi, flo = %.3f*pi, fhi = %.3f*pi \n',bds(:,2)/pi)
Two: bw = 0.294*pi, flo = 0.503*pi, fhi = 0.797*pi
```

Input Arguments

x — Input signal

vector | matrix

Input signal, specified as a vector or matrix. If **x** is a vector, it is treated as a single channel. If **x** is a matrix, then **powerbw** computes the power bandwidth independently for each column. **x** must be finite-valued.

Example: `cos(pi/4*(0:159))+randn(1,160)` is a single-channel row-vector signal.

Example: `cos(pi./[4;2]*(0:159))'+randn(160,2)` is a two-channel signal.

Data Types: `single` | `double`

fs — Sample rate

positive real scalar

Sample rate, specified as a positive real scalar. The sample rate is the number of samples per unit time. If the time is measured in seconds, then the sample rate is in hertz.

Data Types: `single` | `double`

pxx — Power spectral density

vector | matrix

Power spectral density (PSD) estimate, specified as a vector or matrix. If **pxx** is a one-sided estimate, then it must correspond to a real signal. If **pxx** is a matrix, then **powerbw** computes the bandwidth of each column of **pxx** independently.

Example: `periodogram(cos(pi./[4;2]*(0:159))'+randn(160,2))` is the periodogram PSD estimate of a two-channel sinusoid embedded in white Gaussian noise.

Data Types: `single` | `double`

f — Frequencies

vector

Frequencies, specified as a vector. If the first element of `f` is 0, then `powerbw` assumes that the spectrum is a one-sided spectrum of a real signal. In other words, the function doubles the power value in the zero-frequency bin as it seeks the 3-dB point.

Data Types: `single` | `double`

sxx — Power spectrum estimate

vector | matrix

Power spectrum estimate, specified as a vector or matrix. If `sxx` is a matrix, then `obw` computes the bandwidth of each column of `sxx` independently.

Example: `periodogram(cos(pi./[4;2]*(0:159))'+randn(160,2),'power')` is the periodogram power spectrum estimate of a two-channel sinusoid embedded in white Gaussian noise.

Data Types: `single` | `double`

rbw — Resolution bandwidth

positive scalar

Resolution bandwidth, specified as a positive scalar. The resolution bandwidth is the product of two values: the frequency resolution of the discrete Fourier transform and the equivalent noise bandwidth of the window used to compute the PSD.

Data Types: `single` | `double`

freqrange — Frequency range

two-element vector

Frequency range, specified as a two-element vector of real values. If you specify `freqrange`, then the reference level is the average power level in the reference band. If you do not specify `freqrange`, then the reference level is the maximum power level of the spectrum.

Data Types: `single` | `double`

r — Power level drop

$10 \log_{10} 2$ (default) | positive real scalar

Power level drop, specified as a positive real scalar expressed in dB.

Data Types: `single` | `double`

Output Arguments

bw — Power bandwidth

scalar | vector

Power bandwidth, returned as a scalar or vector.

- If you specify a sample rate, then **bw** has the same units as **fs**.
- If you do not specify a sample rate, then **bw** has units of rad/sample.

f1o, f1i — Bandwidth frequency bounds

scalars | vectors

Bandwidth frequency bounds, returned as scalars.

power — Power stored in bandwidth

scalar | vector

Power stored in bandwidth, returned as a scalar or vector.

Algorithms

To determine the 3-dB bandwidth, `powerbw` computes a periodogram power spectrum estimate using a rectangular window and takes the maximum of the estimate as a reference level. The bandwidth is the difference in frequency between the points where the spectrum drops at least 3 dB below the reference level. If the signal reaches one of its endpoints before dropping by 3 dB, then `powerbw` uses the endpoint to compute the difference.

See Also

See Also

`bandpower` | `obw` | `periodogram` | `plomb` | `pwelch`

Introduced in R2015a

prony

Prony method for filter design

Syntax

```
[Num,Den] = prony(impulse_resp,num_ord,denom_ord)
```

Description

`[Num,Den] = prony(impulse_resp,num_ord,denom_ord)` returns the numerator Num and denominator Den coefficients for a causal rational system function with impulse response `impulse_resp`. The system function has numerator order `num_ord` and denominator order `denom_ord`. The lengths of Num and Den are `num_ord+1` and `denom_ord+1`. If the length of `impulse_resp` is less than the largest order (`num_ord` or `denom_ord`), `impulse_resp` is padded with zeros. Enter 0 in `num_ord` for an all-pole system function. For an all-zero system function, enter a 0 for `denom_ord`.

Examples

Filter Responses via Prony's Method

Fit a 4th-order IIR model to the impulse response of a lowpass filter. Plot the original and Prony-designed impulse responses.

```
d = designfilt('lowpassiir','NumeratorOrder',4,'DenominatorOrder',4, ...
    'HalfPowerFrequency',0.2,'DesignMethod','butter');

impulse_resp = filter(d,[1 zeros(1,31)]);
denom_order = 4;
num_order = 4;
[Num,Den] = prony(impulse_resp,num_order,denom_order);

subplot(2,1,1)
stem(impz(Num,Den,length(impulse_resp)))
title 'Impulse Response with Prony Design'

subplot(2,1,2)
```

```
stem(impulse_resp)
title 'Input Impulse Response'
```

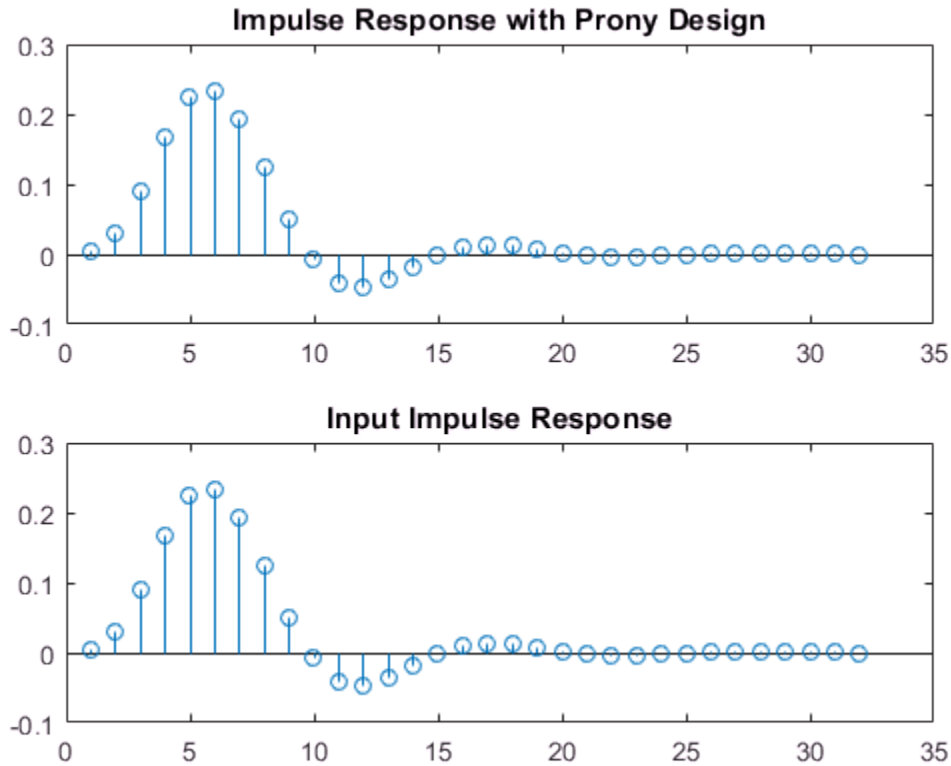

Fit a 10th-order FIR model to the impulse response of a highpass filter. Plot the original and Prony-designed frequency responses.

```
d = designfilt('highpassfir', 'FilterOrder', 10, 'CutoffFrequency', .8);

impulse_resp = filter(d,[1 zeros(1,31)]);
num_order = 10;
denom_order = 0;
[Num,Den] = prony(impulse_resp,num_order,denom_order);

fvt = fvtool(Num,Den,d);
```

```
legend(fvt, 'Prony', 'Original')
```

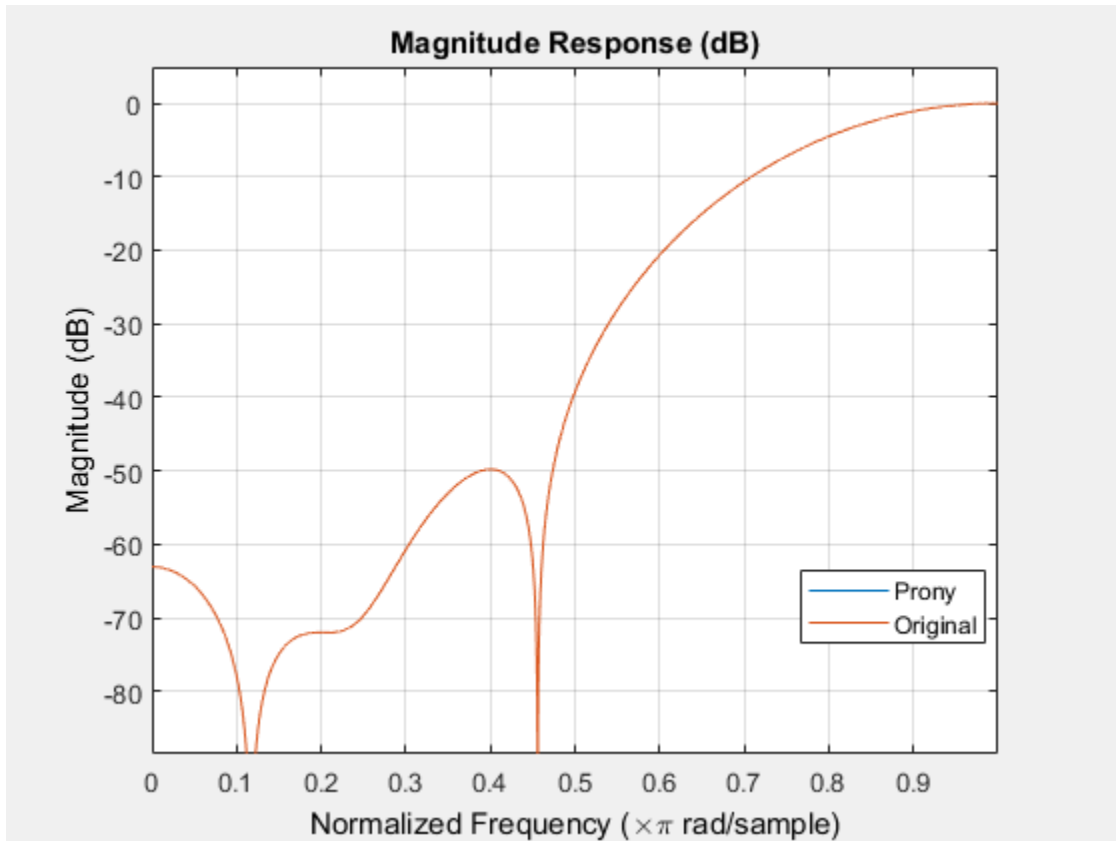

Definitions

System Function

The *system function* is the z-transform of the impulse response $h[n]$:

$$H(z) = \sum_{n=-\infty}^{\infty} h[n]z^{-n}$$

A *rational system function* is a ratio of polynomials in z^{-1} . By convention the numerator polynomial is $B(z)$ and the denominator is $A(z)$. The following equation describes a causal rational system function of numerator order q and denominator order p :

$$H(z) = \frac{\sum_{k=0}^q b[k] z^{-k}}{1 + \sum_{l=1}^p a[l] z^{-l}}$$

where $a[0] = 1$.

References

Parks, Thomas W., and C. Sidney Burrus. *Digital Filter Design*. New York: John Wiley & Sons, 1987, pp 226–228.

See Also

`designfilt` | `lpc` | `impz` | `levinson`

Topics

“Parametric Modeling”

Introduced before R2006a

pulseperiod

Period of bilevel pulse

Syntax

```
P = pulseperiod(X)
P = pulseperiod(X,FS)
P = pulseperiod(X,T)
[P,INITCROSS] = pulseperiod(...)
[P,INITCROSS,FINALCROSS] = pulseperiod(...)
[P,INITCROSS,FINALCROSS,NEXTCROSS] = pulseperiod(...)
[P,INITCROSS,FINALCROSS,NEXTCROSS,MIDLEV] = pulseperiod(...)
[P,INITCROSS,FINALCROSS,NEXTCROSS,MIDLEV] = pulseperiod(...,
Name,Value)
pulseperiod(...)
```

Description

`P = pulseperiod(X)` returns a vector, `P`, containing the difference between the mid-reference level instants of the initial transition of each positive-polarity pulse and the next positive-going transition in the bilevel waveform, `X`. If `pulseperiod` does not find two positive-polarity transitions, `P` is empty. To determine the transitions for each pulse, `pulseperiod` estimates the state levels of the input waveform by a histogram method and identifies all regions which cross the upper-state boundary of the low state and the lower-state boundary of the high state. The low-state and high-state boundaries are expressed as the state level plus or minus a multiple of the difference between the state levels. See “State-Level Tolerances” on page 1-1614. Because `pulseperiod` uses interpolation to determine the mid-reference level instants, `P` may contain values that do not correspond to sampling instants of the bilevel waveform, `X`.

`P = pulseperiod(X,FS)` specifies the sampling rate in hertz as a positive scalar. The first sample instant in `X` corresponds to $t=0$. Because `pulseperiod` uses interpolation to determine the mid-reference level instants, `P` may contain values that do not correspond to sampling instants of the bilevel waveform, `X`.

`P = pulseperiod(X,T)` specifies the sampling instants in a vector equal in length to `X`. Because `pulseperiod` uses interpolation to determine the mid-reference level

instants, **P** may contain values that do not correspond to sampling instants of the bilevel waveform, **X**.

[P, INITCROSS] = `pulseperiod(...)` returns the mid-reference level instants of the first transition of each pulse.

[P, INITCROSS, FINALCROSS] = `pulseperiod(...)` returns the mid-reference level instants of the final transition of each pulse.

[P, INITCROSS, FINALCROSS, NEXTCROSS] = `pulseperiod(...)` returns the mid-reference level instants of next detected transition after each pulse.

[P, INITCROSS, FINALCROSS, NEXTCROSS, MIDLEV] = `pulseperiod(...)` returns the mid-reference level, **MIDLEV**.

[P, INITCROSS, FINALCROSS, NEXTCROSS, MIDLEV] = `pulseperiod(..., Name, Value)` returns the pulse periods with additional options specified by one or more **Name, Value** pair arguments.

`pulseperiod(...)` plots the signal and darkens every other identified pulse. It marks the location of the mid crossings, and their associated reference level. The state levels and their associated lower and upper boundaries (adjustable by the **Name, Value** pair with name 'Tolerance') are also plotted.

Input Arguments

X

Bilevel waveform. If the waveform, **X**, does not contain at least two transitions, `pulseperiod` outputs an empty matrix.

FS

Sample rate in hertz.

T

Vector of sample instants. The length of **T** must equal the length of the bilevel waveform, **X**.

Name-Value Pair Arguments

'MidPercentReferenceLevel'

Mid-reference level as a percentage of the waveform amplitude.

Default: 50

'Polarity'

Pulse polarity. Specify the polarity as `'positive'` or `'negative'`. If you specify `'positive'`, `pulseperiod` looks for pulses whose initial transition is positive-going (positive polarity). If you specify `'negative'`, `pulseperiod` looks for pulses whose initial transition is negative-going (negative polarity).

Default: `'positive'`

'StateLevels'

Low- and high-state levels. `StateLevels` is a 1-by-2 real-valued vector. The first element is the low-state level. The second element is the high-state level. If you do not specify low and high-state levels, `pulseperiod` estimates the state levels from the input waveform using the histogram method.

'Tolerance'

Tolerance levels (lower and upper state boundaries) expressed as a percentage. See “State-Level Tolerances” on page 1-1614.

Default: 2

Output Arguments

P

Pulse period in seconds. The pulse period is defined as the time between the mid-reference level instants of two consecutive transitions.

INITCROSS

Mid-reference level instant of initial transition.

FINALCROSS

Mid-reference level instant of final transition.

NEXTCROSS

Mid-reference level instant of the first pulse transition after the final transition of the preceding pulse.

MIDLEV

Waveform value that corresponds to the mid-reference level.

Examples

Pulse Period of Bilevel Waveform

Compute the pulse period of a bilevel waveform with two positive-polarity transitions. The sample rate is 4 MHz.

```
load('pulseex.mat','x','t')
```

```
p = pulseperiod(x,t)
```

```
p = 5.0030e-06
```

Annotate the pulse period on a plot of the waveform.

```
pulseperiod(x,t);
```

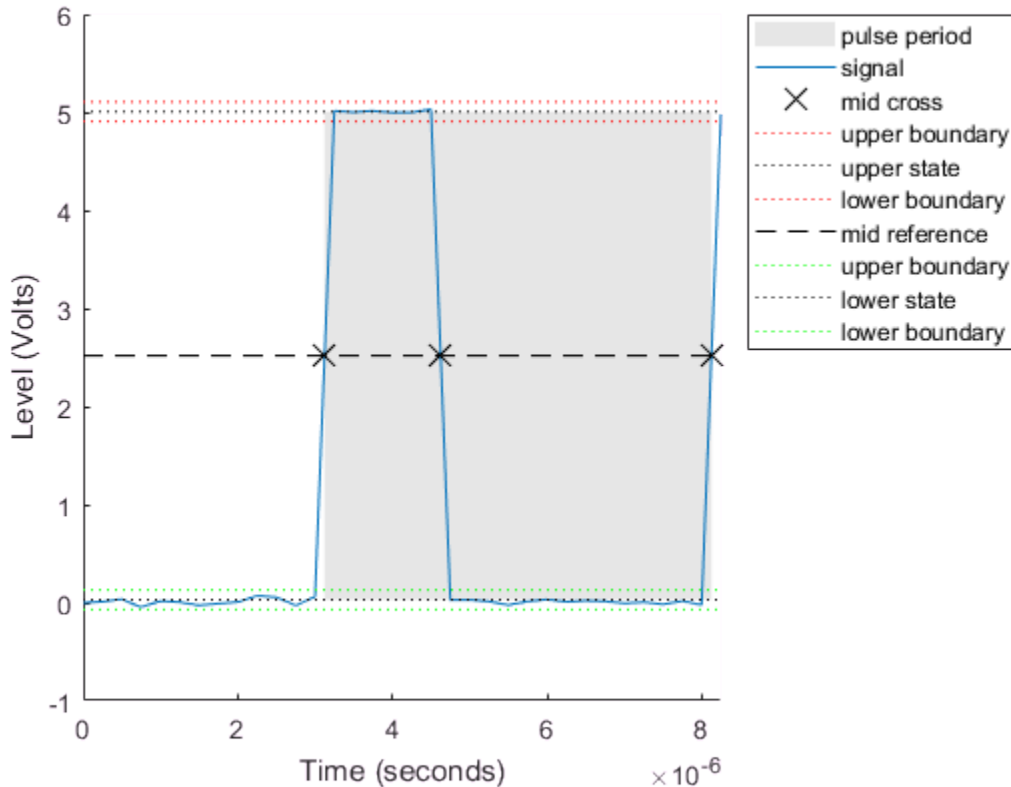
Mid-Reference Level Instants of Pulse Period

Determine the mid-reference level instants that define the pulse period for a bilevel waveform.

```
load('pulseex.mat','x','t')
[~,initcross,~,nextcross] = pulseperiod(x,t)

initcross = 3.1240e-06
nextcross = 8.1270e-06
```

Output the pulse period. Mark the mid-reference level instants on a plot of the data.

```
pulseperiod(x,t)
```

```
ans = 5.0030e-06
```

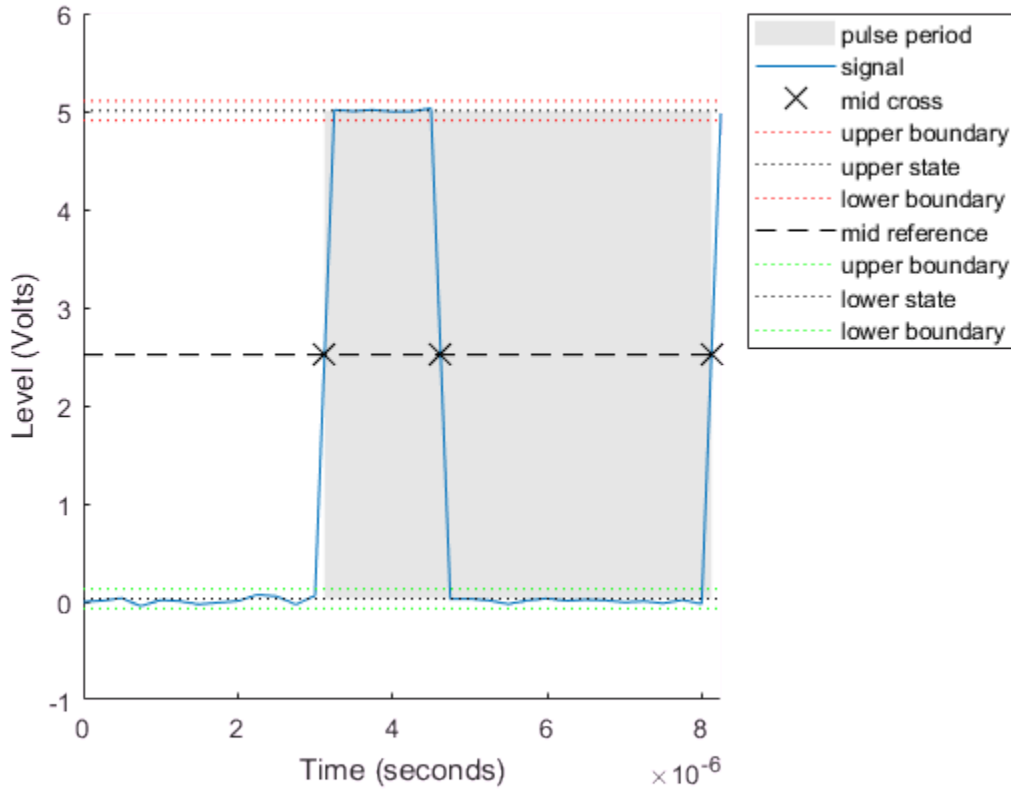

Definitions

Mid-Reference Level

The mid-reference level in a bilevel waveform with low-state level, S_1 , and high- state level, S_2 , is

$$S_1 + \frac{1}{2}(S_2 - S_1)$$

Mid-Reference Level Instant

Let $y_{50\%}$ denote the mid-reference level.

Let $t_{50\%_-}$ and $t_{50\%_+}$ denote the two consecutive sampling instants corresponding to the waveform values nearest in value to $y_{50\%}$.

Let $y_{50\%_-}$ and $y_{50\%_+}$ denote the waveform values at $t_{50\%_-}$ and $t_{50\%_+}$.

The mid-reference level instant is

$$t_{50\%} = t_{50\%_-} + \left(\frac{t_{50\%_+} - t_{50\%_-}}{y_{50\%_+} - y_{50\%_-}} \right) (y_{50\%_+} - y_{50\%_-})$$

Pulse Polarity

If the initial transition of a pulse is positive-going, the pulse has positive polarity. The following figure shows a positive-polarity pulse.

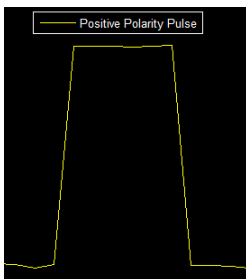

Equivalently, a positive-polarity (positive-going) pulse has a terminating state more positive than the originating state.

If the initial transition of a pulse is negative-going, the pulse has negative polarity. The following figure shows a negative-polarity pulse.

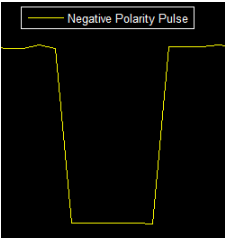

Equivalently, a negative-polarity (negative-going) pulse has a originating state more positive than the terminating state.

State-Level Tolerances

Each state level can have associated lower- and upper-state boundaries. These state boundaries are defined as the state level plus or minus a scalar multiple of the difference between the high state and the low state. To provide a useful tolerance region, the scalar is typically a small number such as 2/100 or 3/100. In general, the $\alpha\%$ region for the low state is defined as

$$S_1 \pm \frac{\alpha}{100}(S_2 - S_1),$$

where S_1 is the low-state level and S_2 is the high-state level. Replace the first term in the equation with S_2 to obtain the $\alpha\%$ tolerance region for the high state.

The following figure illustrates lower and upper 2% state boundaries (tolerance regions) for a positive-polarity bilevel waveform. The red dashed lines indicate the estimated state levels.

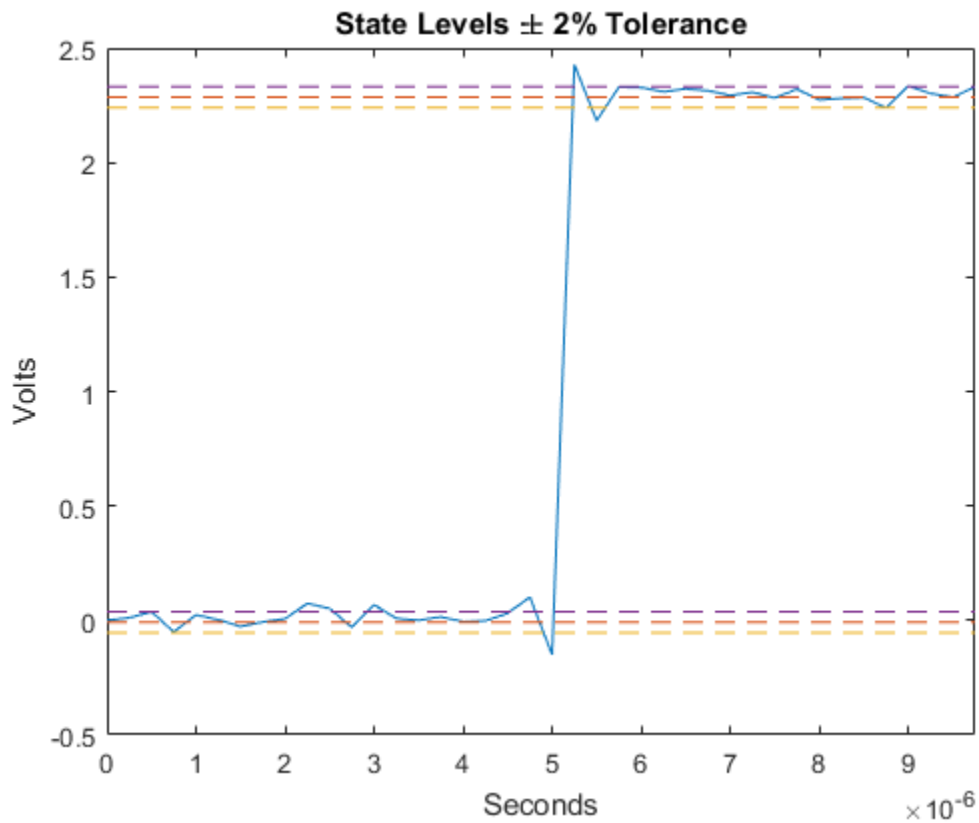

References

- [1] *IEEE Standard on Transitions, Pulses, and Related Waveforms*, IEEE Standard 181, 2003.

See Also

See Also

dutycycle | pulsesep | pulsewidth | statelevels

Introduced in R2012a

pulsesep

Separation between bilevel waveform pulses

Syntax

```

S = pulsesep(X)
S = pulsesep(X,FS)
S = pulsesep(X,T)
[S,INITCROSS] = pulsesep(...)
[S,INITCROSS,FINALCROSS] = pulsesep(...)
[S,INITCROSS,FINALCROSS,NEXTCROSS] = pulsesep(...)
[S,INITCROSS,FINALCROSS,NEXTCROSS,MIDLEV] = pulsesep(...)
[S,INITCROSS,FINALCROSS,NEXTCROSS,MIDLEV] = pulsesep(...,Name,Value)
pulsesep(...)

```

Description

`S = pulsesep(X)` returns the differences, `S`, between the mid-reference level instants of the final negative-going transitions of every positive-polarity pulse and the next positive-going transition. `X` is a bilevel waveform. To determine the transitions that compose each pulse, `pulsesep` estimates the state levels of `X` by a histogram method. `pulsesep` identifies all regions that cross the upper-state boundary of the low state and the lower-state boundary of the high state. The low-state and high-state boundaries are expressed as the state level plus or minus a multiple of the difference between the state levels. See “State-Level Tolerances” on page 1-1624. Because `pulsesep` uses interpolation to determine the mid-reference level instants, `S` may contain values that do not correspond to sampling instants of the bilevel waveform, `X`.

`S = pulsesep(X,FS)` specifies the sampling rate, `FS`, in Hz as a positive scalar. The first time instant corresponds to `t=0`. Because `pulsesep` uses interpolation to determine the mid-reference level instants, `S` may contain values that do not correspond to sampling instants of the bilevel waveform, `X`.

`S = pulsesep(X,T)` specifies the sampling instants, `T`, in a vector equal in length to `X`. Because `pulsesep` uses interpolation to determine the mid-reference level instants, `S`

may contain values that do not correspond to sampling instants of the bilevel waveform, X .

`[S, INITCROSS] = pulsesep(...)` returns the mid-reference level instants, `INITCROSS`, of the first positive-polarity transitions.

`[S, INITCROSS, FINALCROSS] = pulsesep(...)` returns the mid-reference level instants, `FINALCROSS`, of the final transition of each pulse.

`[S, INITCROSS, FINALCROSS, NEXTCROSS] = pulsesep(...)` returns the mid-reference level instants, `NEXTCROSS`, of the next detected transition after each pulse.

`[S, INITCROSS, FINALCROSS, NEXTCROSS, MIDLEV] = pulsesep(...)` returns the mid-reference level, `MIDLEV`.

`[S, INITCROSS, FINALCROSS, NEXTCROSS, MIDLEV] = pulsesep(..., Name, Value)` returns the pulse separations with additional options specified by one or more `Name, Value` pair arguments.

`pulsesep(...)` plots the signal and darkens the regions between each pulse where pulse separation is computed. It marks the location of the mid crossings, and their associated reference level. The state levels and their associated lower and upper boundaries (adjustable by the `Name, Value` pair with name `'Tolerance'`) are also plotted.

Input Arguments

X

Bilevel waveform. If the waveform, X , does not contain at least two transitions, `pulsesep` outputs an empty matrix.

FS

Sample rate in hertz.

T

Vector of sample instants. The length of T must equal the length of the bilevel waveform, X .

Name-Value Pair Arguments

'MidPercentReferenceLevel'

Mid-reference level as a percentage of the waveform amplitude.

Default: 50

'Polarity'

Pulse polarity. Specify the polarity as 'positive' or 'negative'. If you specify 'positive', `pulsesep` looks for pulses with positive-going (positive polarity) initial transitions. If you specify 'negative', `pulsesep` looks for pulses with negative-going (negative polarity) initial transitions. See “Pulse Polarity” on page 1-1623.

Default: 'positive'

'StateLevels'

Low- and high-state levels. `StateLevels` is a 1-by-2 real-valued vector. The first element is the low-state level. The second element is the high-state level. If you do not specify low- and high-state levels, `pulsesep` estimates the state levels from the input waveform using the histogram method.

'Tolerance'

Tolerance levels (lower- and upper-state boundaries) expressed as a percentage. See “State-Level Tolerances” on page 1-1624.

Default: 2

Output Arguments

s

Pulse separations in seconds. The *pulse separation* is defined as the time between the mid-reference level instants of the final transition of one pulse and the initial transition of the next pulse. See “Pulse Separation” on page 1-1625.

INITCROSS

Mid-reference level instants of initial transition.

FINALCROSS

Mid-reference level instants of final transition.

NEXTCROSS

Mid-reference level instants of the initial transition after the final transition of the preceding pulse.

MIDLEV

Waveform value that corresponds to the mid-reference level.

Examples

Pulse Separation in Bilevel Waveform

Compute the pulse separation in a bilevel waveform with two positive-polarity transitions. The sample rate is 4 MHz.

```
load('pulseex.mat','x','t')
```

```
s = pulsesep(x,t)
```

```
s = 3.5014e-06
```

Plot the waveform and annotate the pulse separation.

```
pulsesep(x,t);
```

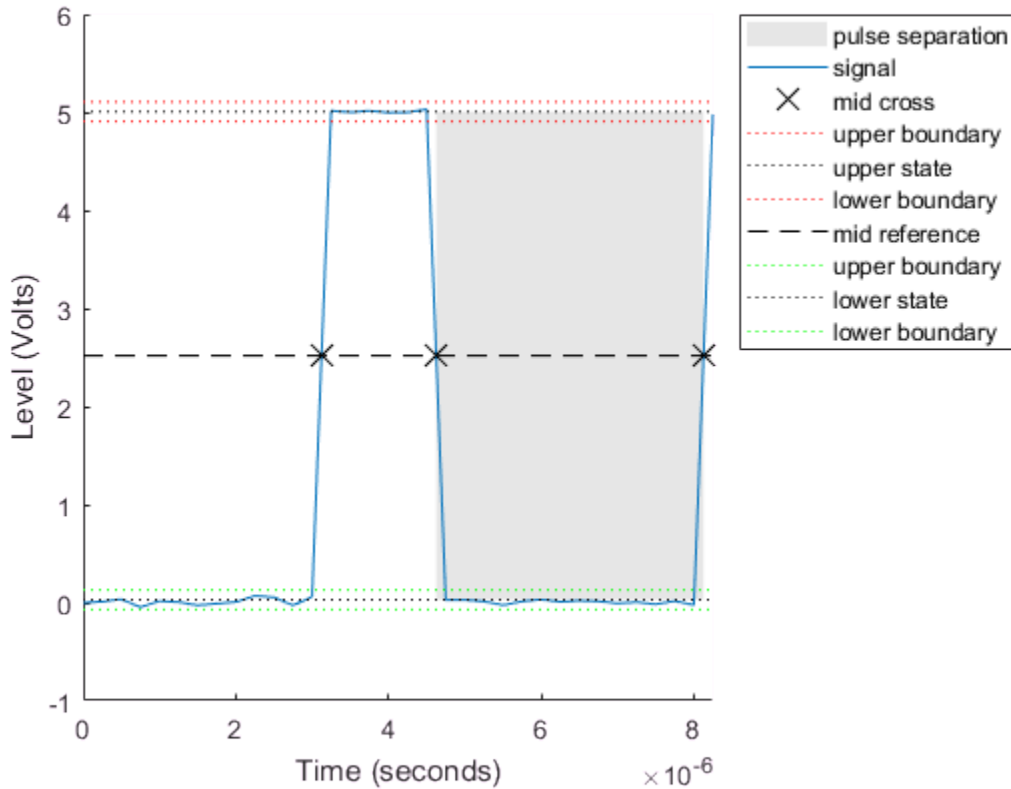

Mid-Reference Level Instants Defining Pulse Separation

Determine the mid-reference level instants that define the pulse separation for a bilevel waveform.

```
load('pulseex.mat','x','t')
```

```
[~,~,finalcross,nextcross] = pulsesep(x,t)
```

```
finalcross = 4.6256e-06
```

```
nextcross = 8.1270e-06
```

Return the pulse separation. Annotate the mid-reference level instants on a plot of the data.

```
pulsesep(x,t)
```

```
ans = 3.5014e-06
```

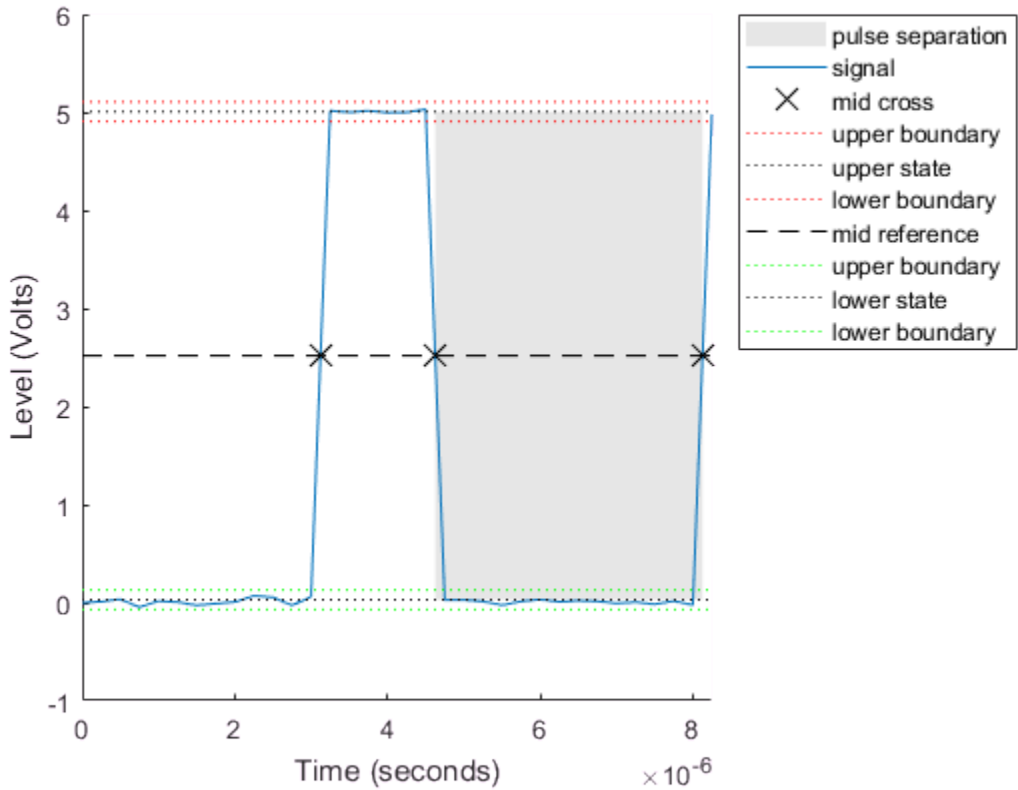

Definitions

Mid-Reference Level

The mid-reference level in a bilevel waveform with low-state level, S_1 , and high-state level, S_2 , is

$$S_1 + \frac{1}{2}(S_2 - S_1)$$

Mid-Reference Level Instant

Let $y_{50\%}$ denote the mid-reference level.

Let $t_{50\%_-}$ and $t_{50\%_+}$ denote the two consecutive sampling instants corresponding to the waveform values nearest in value to $y_{50\%}$.

Let $y_{50\%_-}$ and $y_{50\%_+}$ denote the waveform values at $t_{50\%_-}$ and $t_{50\%_+}$.

The mid-reference level instant is

$$t_{50\%} = t_{50\%_-} + \left(\frac{t_{50\%_+} - t_{50\%_-}}{y_{50\%_+} - y_{50\%_-}} \right) (y_{50\%_+} - y_{50\%_-})$$

Pulse Polarity

If the pulse has an initial positive-going transition, the pulse has positive polarity. The following figure shows a positive-polarity pulse.

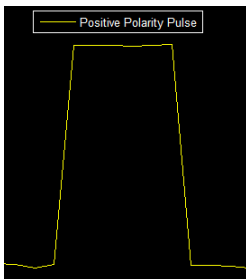

Equivalently, a positive-polarity (positive-going) pulse has a terminating state more positive than the originating state.

If the pulse has an initial negative-going transition, the pulse has negative polarity. The following figure shows a negative-polarity pulse.

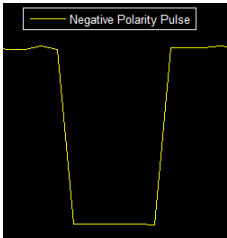

Equivalently, a negative-polarity (negative-going) pulse has a originating state more positive than the terminating state.

State-Level Tolerances

Each state level can have associated lower- and upper-state boundaries. These state boundaries are defined as the state level plus or minus a scalar multiple of the difference between the high state and the low state. To provide a useful tolerance region, the scalar is typically a small number such as 2/100 or 3/100. In general, the $\alpha\%$ region for the low state is defined as

$$S_1 \pm \frac{\alpha}{100}(S_2 - S_1),$$

where S_1 is the low-state level and S_2 is the high-state level. Replace the first term in the equation with S_2 to obtain the $\alpha\%$ tolerance region for the high state.

The following figure illustrates lower and upper 2% state boundaries (tolerance regions) for a positive-polarity bilevel waveform. The red dashed lines indicate the estimated state levels.

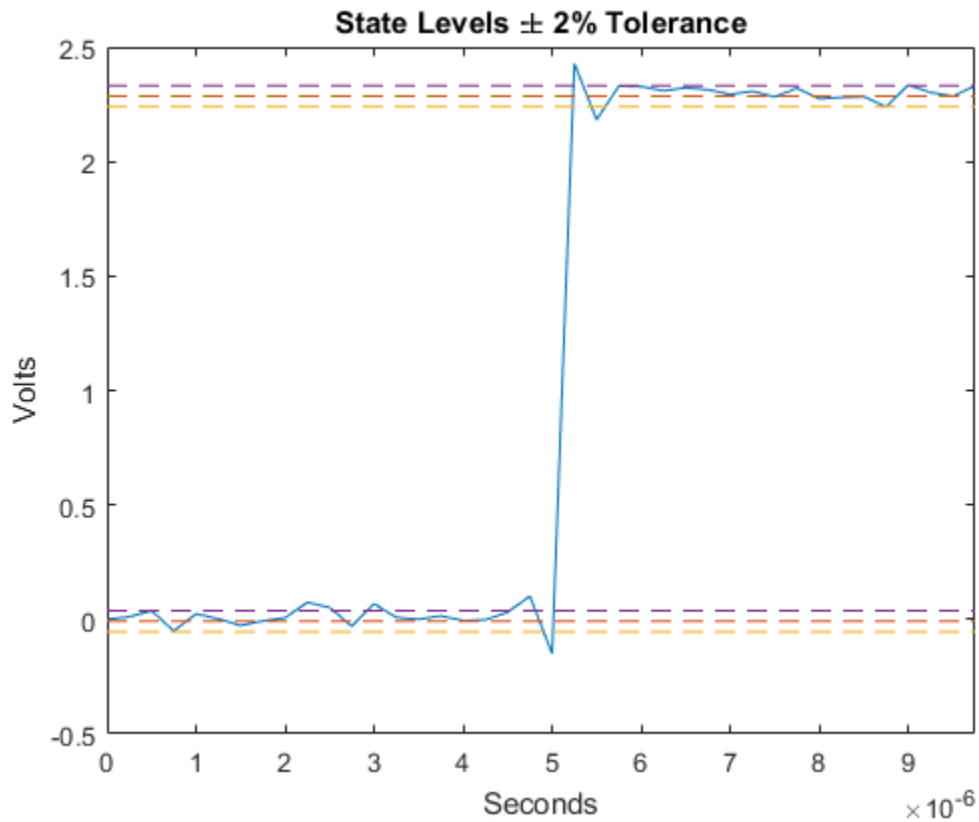

Pulse Separation

Pulse separation is the time difference between the mid-reference level instant of the final transition of one pulse and the mid-reference level instant of the initial transition of the next pulse. The following figure illustrates pulse separation.

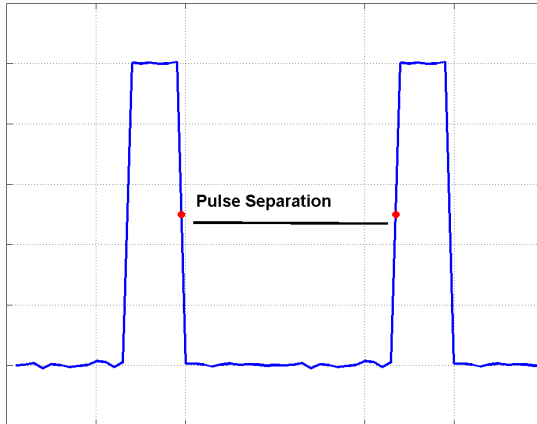

References

- [1] *IEEE Standard on Transitions, Pulses, and Related Waveforms*, IEEE Standard 181, 2003.

See Also

See Also

`dutycycle` | `pulseperiod` | `pulsewidth` | `statelevels`

Introduced in R2012a

pulsewidth

Bilevel waveform pulse width

Syntax

```
W = pulsewidth(X)
W = pulsewidth(X,FS)
W = pulsewidth(X,T)
[W,INITCROSS] = pulsewidth(...)
[W,INITCROSS,FINALCROSS] = pulsewidth(...)
[W,INITCROSS,FINALCROSS,MIDLEV] = pulsewidth(...)
W = pulsewidth(...,Name,Value)
pulsewidth(...)
```

Description

`W = pulsewidth(X)` returns a vector, `W`, containing the time differences between the mid-reference level instants of the initial and final transitions of each positive-polarity pulse in the bilevel waveform, `X`. To determine the transitions, `pulsewidth` estimates the low- and high-state levels of `X` by a histogram method. `pulsewidth` identifies all regions that cross the upper-state boundary of the low state and the lower-state boundary of the high state. The low-state and high-state boundaries are expressed as the state level plus or minus a multiple of the difference between the state levels. See “State-Level Tolerances” on page 1-1635. Because `pulsewidth` uses interpolation to determine the mid-reference level instants, `W` may contain values that do not correspond to sampling instants of the bilevel waveform, `X`.

`W = pulsewidth(X,FS)` specifies the sample rate, `FS`, in hertz as a positive scalar. The first sample in the waveform corresponds to $t=0$. Because `pulsewidth` uses interpolation to determine the mid-reference level instants, `W` may contain values that do not correspond to sampling instants of the bilevel waveform, `X`.

`W = pulsewidth(X,T)` specifies the sample instants, `T`, as a vector with the same number of elements as `X`. Because `pulsewidth` uses interpolation to determine the mid-reference level instants, `W` may contain values that do not correspond to sampling instants of the bilevel waveform, `X`.

`[W,INITCROSS] = pulsewidth(...)` returns a column vector, `INITCROSS`, whose elements correspond to the mid-reference level instants of the initial transition of each pulse.

`[W,INITCROSS,FINALCROSS] = pulsewidth(...)` returns a column vector, `FINALCROSS`, whose elements correspond to the mid-reference level instants of the final transition of each pulse.

`[W,INITCROSS,FINALCROSS,MIDLEV] = pulsewidth(...)` returns the waveform value, `MIDLEV`, which corresponds to the mid-reference level.

`W = pulsewidth(...,Name,Value)` returns the pulse widths with additional options specified by one or more `Name,Value` pair arguments.

`pulsewidth(...)` plots the signal and darkens the regions of each pulse where pulse width is computed. It marks the location of the mid crossings, and their associated reference level. The state levels and their associated lower and upper boundaries (adjustable by the `Name,Value` pair with name `'Tolerance'`) are also plotted.

Input Arguments

X

Bilevel waveform. `X` is a real-valued row or column vector.

FS

Sample rate in hertz.

T

Vector of sample instants. The length of `T` must equal the length of the bilevel waveform, `X`.

Name-Value Pair Arguments

'MidPercentReferenceLevel'

Mid-reference level as percentage of the waveform amplitude. See “Mid-Reference Level” on page 1-1633.

Default: 50

'Polarity'

Pulse polarity. Specify the polarity as 'positive' or 'negative'. If you specify 'positive', pulsewidth looks for pulses with positive-going (positive polarity) initial transitions. If you specify 'negative', pulsewidth looks for pulses with negative-going (negative polarity) initial transitions. See “Pulse Polarity” on page 1-1634.

Default: 'positive'

'StateLevels'

Low- and high-state levels. StateLevels is a 1-by-2 real-valued vector. The first element is the low-state level. The second element is the high-state level. If you do not specify low- and high-state levels, pulsewidth estimates the state levels from the input waveform using the histogram method.

'Tolerance'

Tolerance levels (lower and upper state boundaries) expressed as a percentage. See “State-Level Tolerances” on page 1-1635.

Default: 2

Output Arguments

W

Pulse widths in seconds. The pulse width is the time difference between the initial and final transitions of a pulse. The times of the initial and final transitions are referred to as *transition occurrence instants* in [1].

INITCROSS

Mid-reference level instants of the initial transition

FINALCROSS

Mid-reference level instants of the final transition

MIDLEV

Waveform value corresponding to the mid-reference level

Examples

Pulse Width of Bilevel Waveform

Compute the pulse width of a bilevel waveform sampled at 4 MHz.

```
load('pulseex.mat','x','t')
w = pulsewidth(x,t)
```

```
w = 1.5016e-06
```

Plot the waveform and annotate the pulse width.

```
pulsewidth(x,t);
```

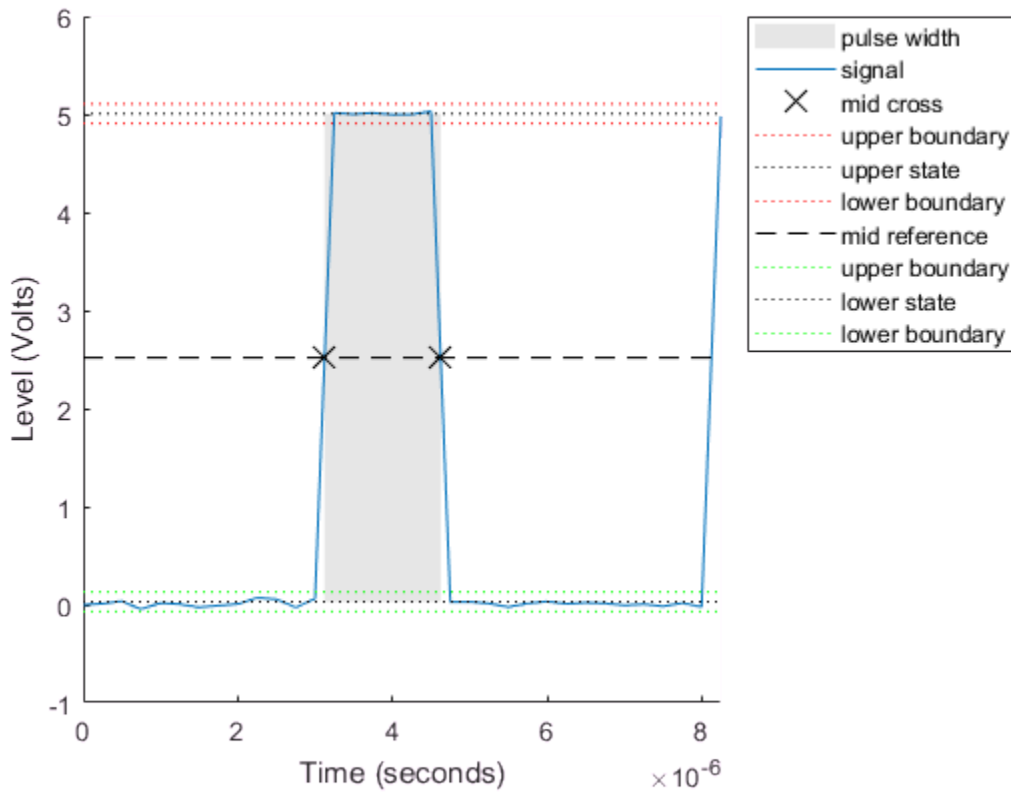

First and Second Transition Times for Bilevel Waveform

Compute the initial and final transition occurrences for a bilevel waveform sampled at 4 MHz.

```
load('pulseex.mat', 'x', 't');
fs = 4e6;
```

```
[w,initcross,finalcross] = pulsewidth(x,fs);
```

Plot the result, annotated with the transition occurrences.

```
pulsewidth(x,fs);
ax = gca;
ax.XTick = [initcross finalcross];
```

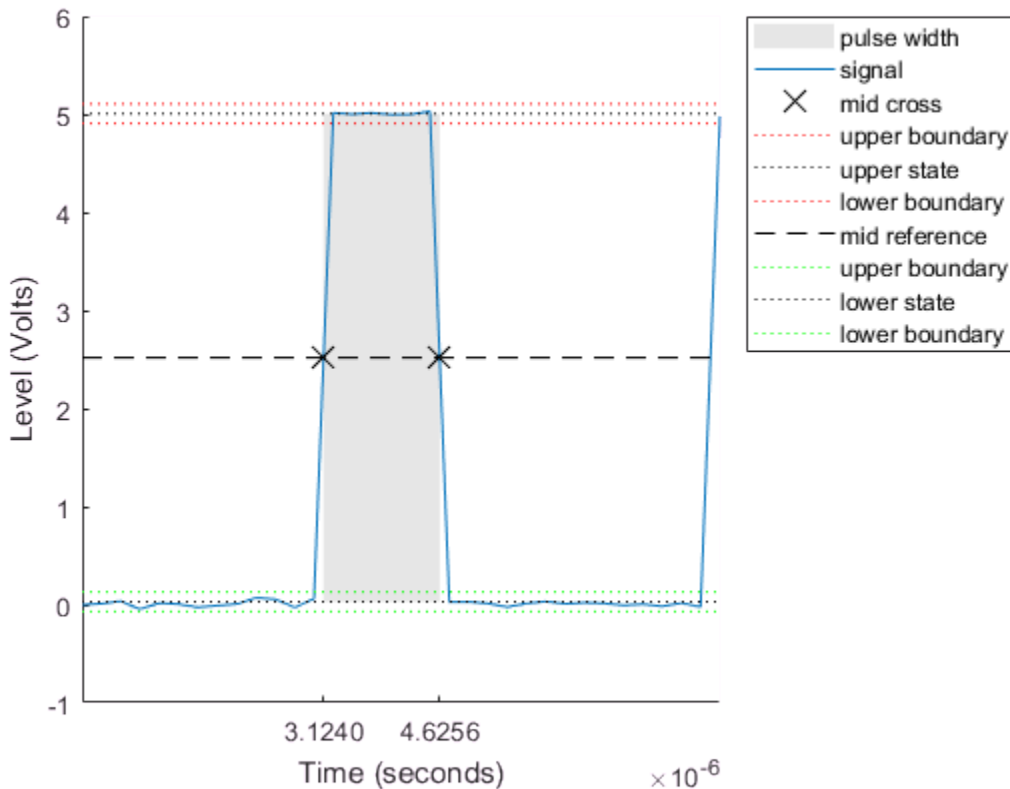

Specify State Levels for Bilevel Waveform

Specify the state levels for the bilevel waveform instead of estimating the levels from the data. Use the 'StateLevels' name-value pair to enter the low-state level as 0 and the high-state level as 5.

```
load('pulseex.mat', 'x', 't')
fs = 4e6;
[w,initcross,finalcross] = pulsewidth(x,fs,'StateLevels',[0 5]);
```

Plot the result annotated with the transition occurrences.

```
pulsewidth(x,fs,'StateLevels',[0 5]);
ax = gca;
ax.XTick = [initcross finalcross];
```

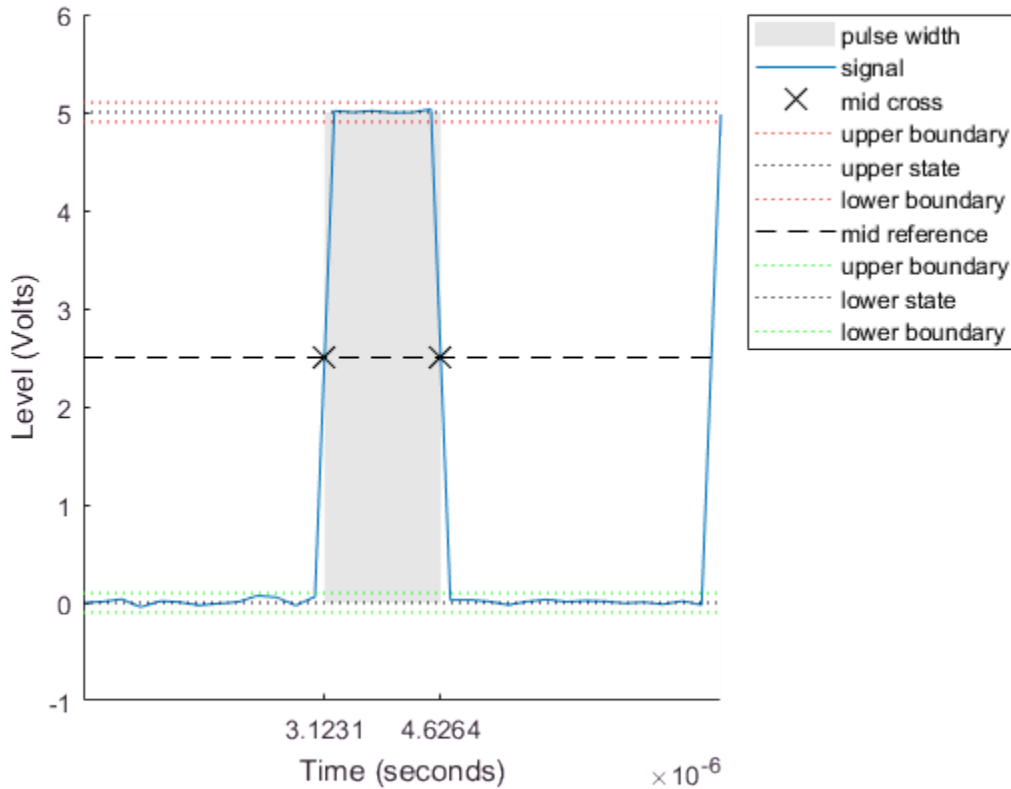

Definitions

Mid-Reference Level

The mid-reference level in a bilevel waveform with low-state level, S_1 , and high-state level, S_2 , is

$$S_1 + \frac{1}{2}(S_2 - S_1)$$

Mid-Reference Level Instant

Let $y_{50\%}$ denote the mid-reference level.

Let $t_{50\%_-}$ and $t_{50\%_+}$ denote the two consecutive sampling instants corresponding to the waveform values nearest in value to $y_{50\%}$.

Let $y_{50\%_-}$ and $y_{50\%_+}$ denote the waveform values at $t_{50\%_-}$ and $t_{50\%_+}$.

The mid-reference level instant is

$$t_{50\%} = t_{50\%_-} + \left(\frac{t_{50\%_+} - t_{50\%_-}}{y_{50\%_+} - y_{50\%_-}} \right) (y_{50\%_+} - y_{50\%_-})$$

Pulse Polarity

If the pulse has a positive-going initial transition, the pulse has positive polarity. The following figure shows a positive-polarity pulse.

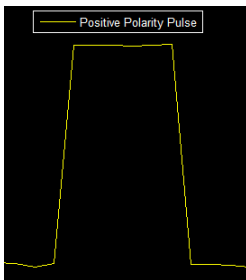

Equivalently, a positive-polarity (positive-going) pulse has a terminating state more positive than the originating state.

If the pulse has a negative-going initial transition, the pulse has negative polarity. The following figure shows a negative-polarity pulse.

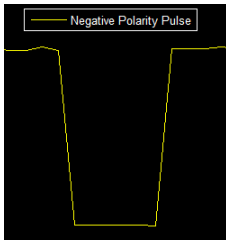

Equivalently, a negative-polarity (negative-going) pulse has a originating state more positive than the terminating state.

State-Level Tolerances

Each state level can have associated lower- and upper-state boundaries. These state boundaries are defined as the state level plus or minus a scalar multiple of the difference between the high state and the low state. To provide a useful tolerance region, the scalar is typically a small number such as 2/100 or 3/100. In general, the $\alpha\%$ region for the low state is defined as

$$S_1 \pm \frac{\alpha}{100}(S_2 - S_1),$$

where S_1 is the low-state level and S_2 is the high-state level. Replace the first term in the equation with S_2 to obtain the $\alpha\%$ tolerance region for the high state.

The following figure illustrates lower and upper 2% state boundaries (tolerance regions) for a positive-polarity bilevel waveform. The red dashed lines indicate the estimated state levels.

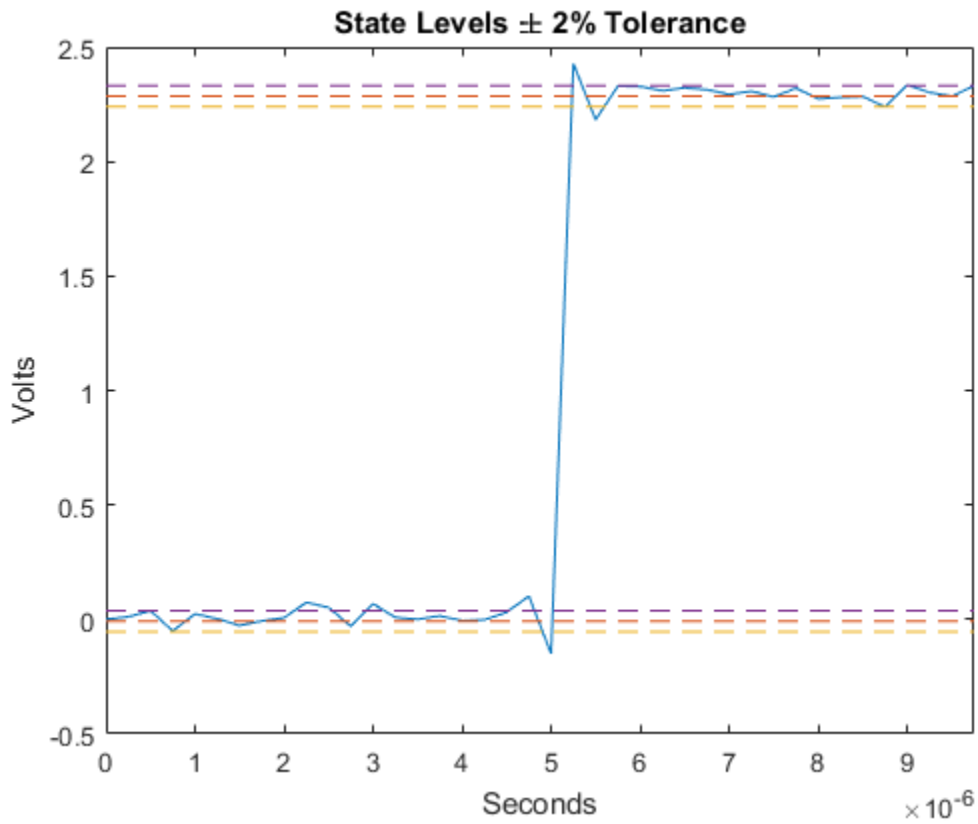

References

- [1] *IEEE Standard on Transitions, Pulses, and Related Waveforms*, IEEE Standard 181, 2003.

See Also

See Also

dutycycle | pulseperiod | pulsesep | statelevels

Introduced in R2012a

pulstran

Pulse train

Syntax

```
pulstran
y = pulstran(t,d,'func')
pulstran(t,d,'func',p1,p2,...)
pulstran(t,d,p,fs)
pulstran(t,d,p)
pulstran(...,'func')
```

Description

`pulstran` generates pulse trains from continuous functions or sampled prototype pulses.

`y = pulstran(t,d,'func')` generates a pulse train based on samples of a continuous function, '*func*', where '*func*' is

- '`gauspuls`', for generating a Gaussian-modulated sinusoidal pulse
- '`rectpuls`', for generating a sampled aperiodic rectangle
- '`tripuls`', for generating a sampled aperiodic triangle

`pulstran` is evaluated `length(d)` times and returns the sum of the evaluations

```
y = func(t-d(1)) + func(t-d(2)) + ...
```

The function is evaluated over the range of argument values specified in array `t`, after removing a scalar argument offset taken from the vector `d`. Note that *func* must be a vectorized function that can take an array `t` as an argument.

An optional gain factor may be applied to each delayed evaluation by specifying `d` as a two-column matrix, with the offset defined in column 1 and associated gain in column 2 of `d`. Note that a row vector will be interpreted as specifying delays only.

`pulstran(t,d,'func',p1,p2,...)` allows additional parameters to be passed to '*func*' as necessary. For example:

```
func(t-d(1),p1,p2,...) + func(t-d(2),p1,p2,...) + ...
```

`pulstran(t,d,p,fs)` generates a pulse train that is the sum of multiple delayed interpolations of the prototype pulse in vector `p`, sampled at the rate `fs`, where `p` spans the time interval `[0,(length(p)-1)/fs]`, and its samples are identically 0 outside this interval. By default, linear interpolation is used for generating delays.

`pulstran(t,d,p)` assumes that the sampling rate `fs` is equal to 1 Hz.

`pulstran(...,'func')` specifies alternative interpolation methods. See `interp1` for a list of available methods.

Examples

Asymmetric Sawtooth Waveform

This example generates an asymmetric sawtooth waveform with a repetition frequency of 3 Hz and a sawtooth width of 0.1 s. The signal length is 1 s and the sample rate is 1 kHz.

```
t = 0 : 1/1e3 : 1;          % 1 kHz sample freq for 1 s
d = 0 : 1/3 : 1;          % 3 Hz repetition frequency
y = pulstran(t,d,'tripuls',0.1,-1);

plot(t,y)
xlabel 'Time (s)', ylabel Waveform
```

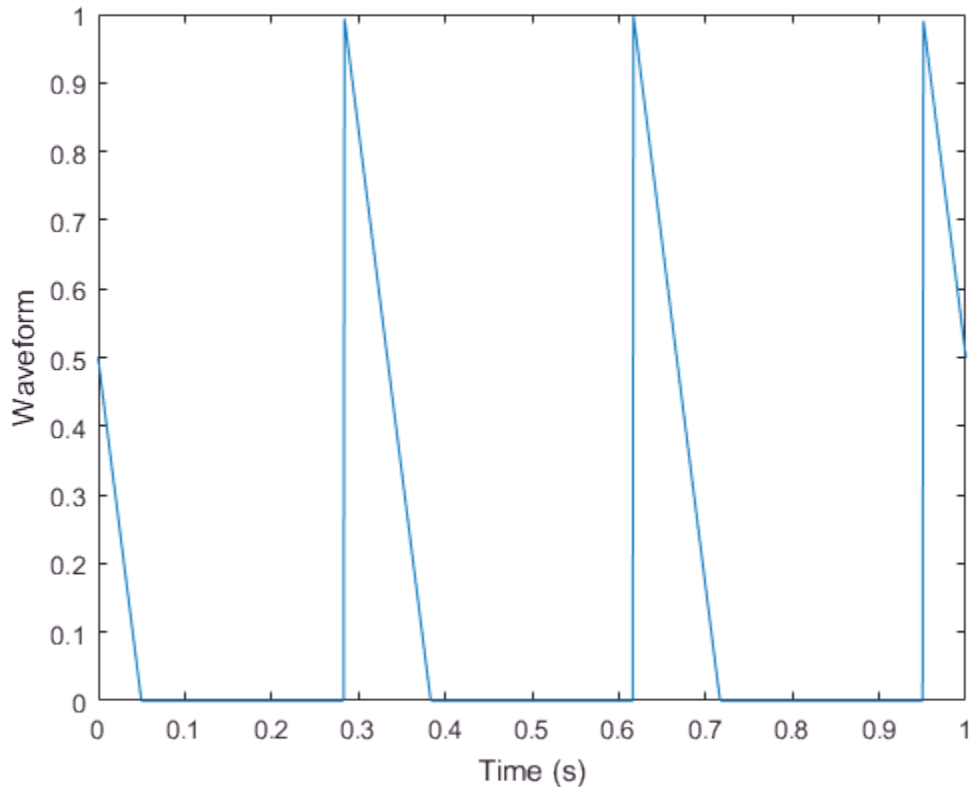

Periodic Gaussian Pulse

This example generates a periodic Gaussian pulse signal at 10 kHz with 50% bandwidth. The pulse repetition frequency is 1 kHz, the sample rate is 50 kHz, and the pulse train length is 10 ms. Each pulse has 80% of the amplitude of the preceding pulse.

```
t = 0 : 1/50e3 : 10e-3;
d = [0 : 1/1e3 : 10e-3 ; 0.8.^(0:10)]';
y = pulstran(t,d,'gauspuls',10e3,0.5);

plot(t,y)
xlabel 'Time (s)', ylabel 'Periodic Gaussian pulse'
```

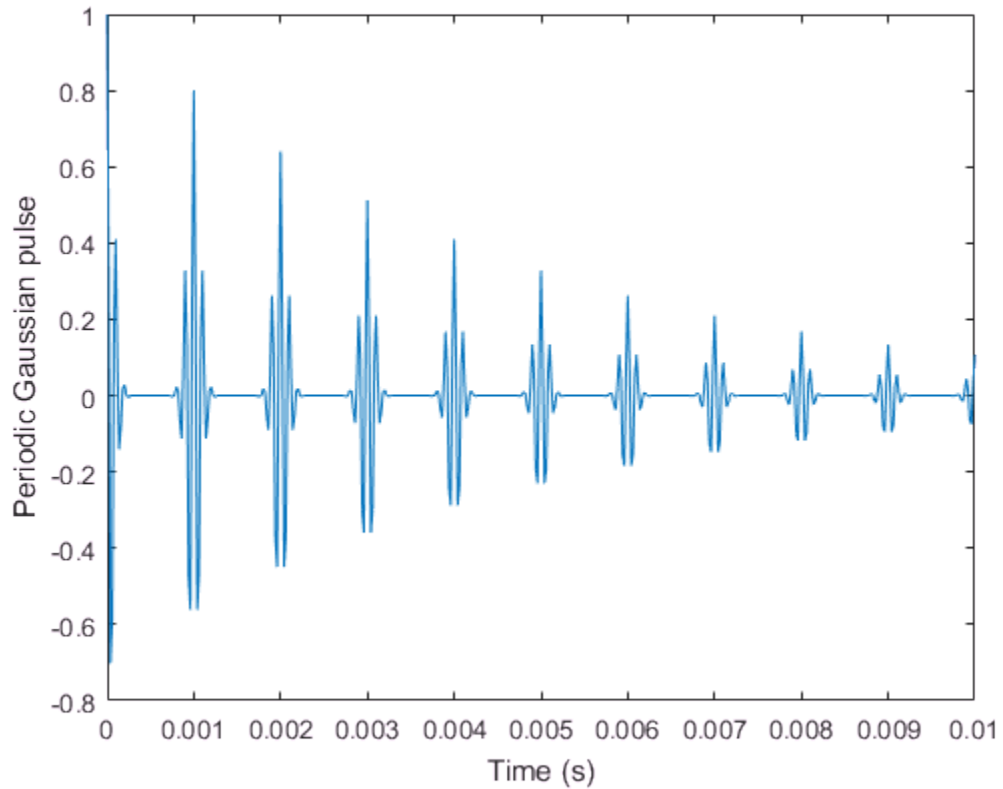

See Also

chirp | cos | diric | gauspuls | rectpuls | sawtooth | sin | sinc | square | tripuls

Introduced before R2006a

pwelch

Welch's power spectral density estimate

Syntax

```
pxx = pwelch(x)
pxx = pwelch(x,window)
pxx = pwelch(x,window,noverlap)
pxx = pwelch(x,window,noverlap,nfft)

[pxx,w] = pwelch( ___ )
[pxx,f] = pwelch( ___ ,fs)

[pxx,w] = pwelch(x,window,noverlap,w)
[pxx,f] = pwelch(x,window,noverlap,f,fs)

[ ___ ] = pwelch(x,window, ___ ,freqrange)
[ ___ ] = pwelch(x,window, ___ ,spectrumtype)
[ ___ ] = pwelch(x,window, ___ ,trace)

[ ___ ,pxxc] = pwelch( ___ ,'ConfidenceLevel',probability)

pwelch( ___ )
```

Description

`pxx = pwelch(x)` returns the power spectral density (PSD) estimate, `pxx`, of the input signal, `x`, found using Welch's overlapped segment averaging estimator. When `x` is a vector, it is treated as a single channel. When `x` is a matrix, the PSD is computed independently for each column and stored in the corresponding column of `pxx`. If `x` is real-valued, `pxx` is a one-sided PSD estimate. If `x` is complex-valued, `pxx` is a two-sided PSD estimate. By default, `x` is divided into the longest possible segments to obtain as close to but not exceed 8 segments with 50% overlap. Each segment is windowed with a Hamming window. The modified periodograms are averaged to obtain the PSD estimate. If you cannot divide the length of `x` exactly into an integer number of segments with 50% overlap, `x` is truncated accordingly.

`pxx = pwelch(x,window)` uses the input vector or integer, `window`, to divide the signal into segments. If `window` is a vector, `pwelch` divides the signal into segments equal in length to the length of `window`. The modified periodograms are computed using the signal segments multiplied by the vector, `window`. If `window` is an integer, the signal is divided into segments of length `window`. The modified periodograms are computed using a Hamming window of length `window`.

`pxx = pwelch(x,window,noverlap)` uses `noverlap` samples of overlap from segment to segment. `noverlap` must be a positive integer smaller than `window` if `window` is an integer. `noverlap` must be a positive integer less than the length of `window` if `window` is a vector. If you do not specify `noverlap`, or specify `noverlap` as empty, the default number of overlapped samples is 50% of the window length.

`pxx = pwelch(x,window,noverlap,nfft)` specifies the number of discrete Fourier transform (DFT) points to use in the PSD estimate. The default `nfft` is the greater of 256 or the next power of 2 greater than the length of the segments.

`[pxx,w] = pwelch(____)` returns the normalized frequency vector, `w`. If `pxx` is a one-sided PSD estimate, `w` spans the interval $[0,\pi]$ if `nfft` is even and $[0,\pi)$ if `nfft` is odd. If `pxx` is a two-sided PSD estimate, `w` spans the interval $[0,2\pi)$.

`[pxx,f] = pwelch(____,fs)` returns a frequency vector, `f`, in cycles per unit time. The sample rate, `fs`, is the number of samples per unit time. If the unit of time is seconds, then `f` is in cycles/sec (Hz). For real-valued signals, `f` spans the interval $[0,fs/2]$ when `nfft` is even and $[0,fs/2)$ when `nfft` is odd. For complex-valued signals, `f` spans the interval $[0,fs)$. `fs` must be the fifth input to `pwelch`. To input a sample rate and still use the default values of the preceding optional arguments, specify these arguments as empty, `[]`.

`[pxx,w] = pwelch(x,window,noverlap,w)` returns the two-sided Welch PSD estimates at the normalized frequencies specified in the vector, `w`. The vector, `w`, must contain at least 2 elements.

`[pxx,f] = pwelch(x,window,noverlap,f,fs)` returns the two-sided Welch PSD estimates at the frequencies specified in the vector, `f`. The vector, `f`, must contain at least 2 elements. The frequencies in `f` are in cycles per unit time. The sample rate, `fs`, is the number of samples per unit time. If the unit of time is seconds, then `f` is in cycles/sec (Hz).

`[____] = pwelch(x,window,____,freqrange)` returns the Welch PSD estimate over the frequency range specified by `freqrange`. Valid options for `freqrange` are: 'onesided', 'twosided', or 'centered'.

[___] = `pwelch(x,window, ___, spectrumtype)` returns the PSD estimate if `spectrumtype` is specified as 'psd' and returns the power spectrum if `spectrumtype` is specified as 'power'.

[___] = `pwelch(x,window, ___, trace)` returns the maximum-hold spectrum estimate if `trace` is specified as 'maxhold' and returns the minimum-hold spectrum estimate if `trace` is specified as 'minhold'.

[___, pxxc] = `pwelch(___, 'ConfidenceLevel', probability)` returns the `probability` × 100% confidence intervals for the PSD estimate in `pxxc`.

`pwelch(___)` with no output arguments plots the Welch PSD estimate in the current figure window.

Examples

Welch Estimate Using Default Inputs

Obtain the Welch PSD estimate of an input signal consisting of a discrete-time sinusoid with an angular frequency of $\pi/4$ rad/sample with additive $N(0,1)$ white noise.

Create a sine wave with an angular frequency of $\pi/4$ rad/sample with additive $N(0,1)$ white noise. Reset the random number generator for reproducible results. The signal is 320 samples in length.

```
rng default
```

```
n = 0:319;  
x = cos(pi/4*n)+randn(size(n));
```

Obtain the Welch PSD estimate using the default Hamming window and DFT length. The default segment length is 71 samples and the DFT length is the 256 points yielding a frequency resolution of $2\pi/256$ rad/sample. Because the signal is real-valued, the periodogram is one-sided and there are $256/2+1$ points.

```
pxx = pwelch(x);  
plot(10*log10(pxx))
```

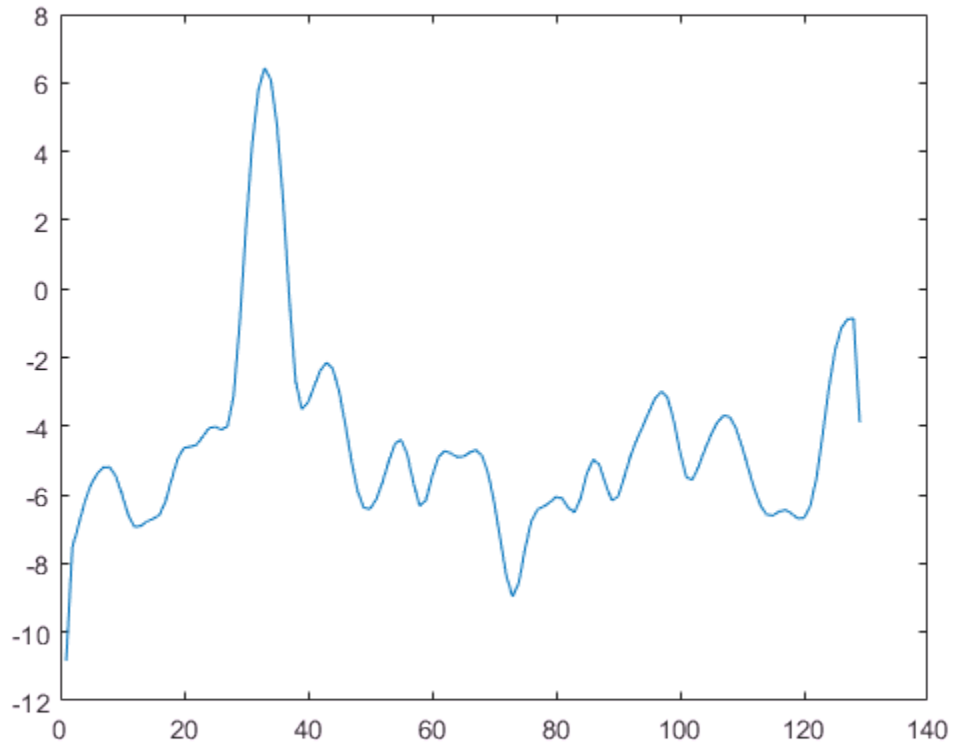

Welch Estimate Using Specified Segment Length

Obtain the Welch PSD estimate of an input signal consisting of a discrete-time sinusoid with an angular frequency of $\pi/4$ rad/sample with additive $N(0,1)$ white noise.

Create a sine wave with an angular frequency of $\pi/4$ rad/sample with additive $N(0,1)$ white noise. Reset the random number generator for reproducible results. The signal is 320 samples in length.

```
rng default
```

```
n = 0:319;
```

```
x = cos(pi/4*n)+randn(size(n));
```

Obtain the Welch PSD estimate dividing the signal into segments 100 samples in length. The signal segments are multiplied by a Hamming window 100 samples in length. The number of overlapped samples is 25. The DFT length is 256 points, yielding a frequency resolution of $2\pi/256$ rad/sample. Because the signal is real-valued, the PSD estimate is one-sided and there are 256/2+1 points.

```
segmentLength = 100;  
noverlap = 25;  
pxx = pwelch(x,segmentLength,noverlap);  
  
plot(10*log10(pxx))
```

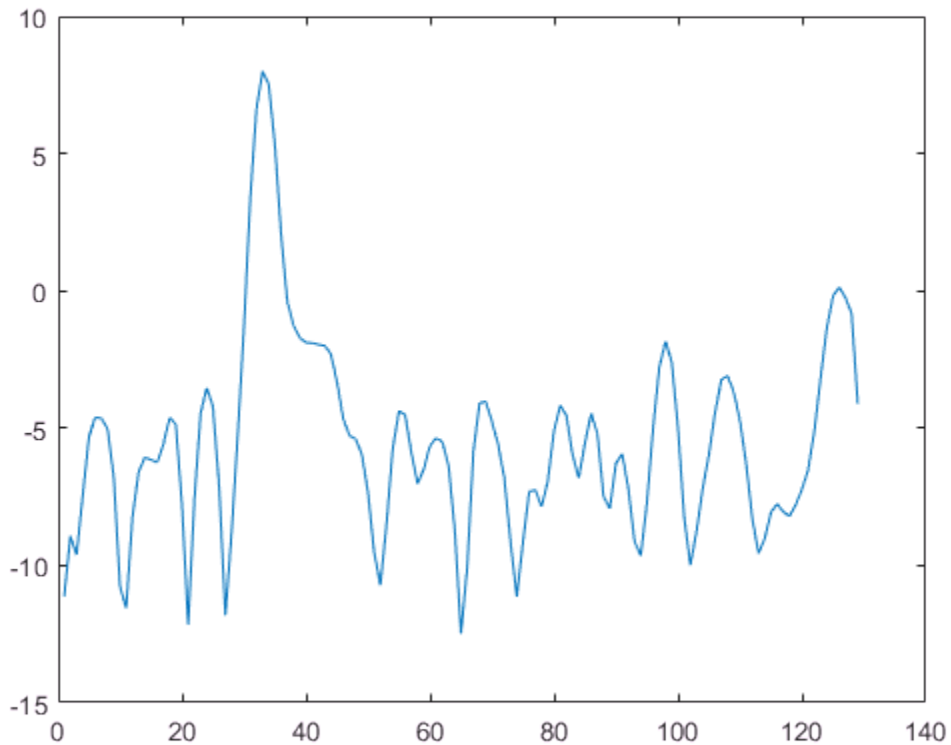

Welch Estimate Specifying Segment Overlap

Obtain the Welch PSD estimate of an input signal consisting of a discrete-time sinusoid with an angular frequency of $\pi/4$ rad/sample with additive $N(0, 1)$ white noise.

Create a sine wave with an angular frequency of $\pi/4$ rad/sample with additive $N(0, 1)$ white noise. Reset the random number generator for reproducible results. The signal is 320 samples in length.

```
rng default
```

```
n = 0:319;  
x = cos(pi/4*n)+randn(size(n));
```

Obtain the Welch PSD estimate dividing the signal into segments 100 samples in length. The signal segments are multiplied by a Hamming window 100 samples in length. The number of overlapped samples is 25. The DFT length is 256 points yielding a frequency resolution of $2\pi/256$ rad/sample. Because the signal is real-valued, the PSD estimate is one-sided and there are $256/2+1$ points.

```
segmentLength = 100;  
noverlap = 25;  
pxx = pwelch(x,segmentLength,noverlap);  
  
plot(10*log10(pxx))
```

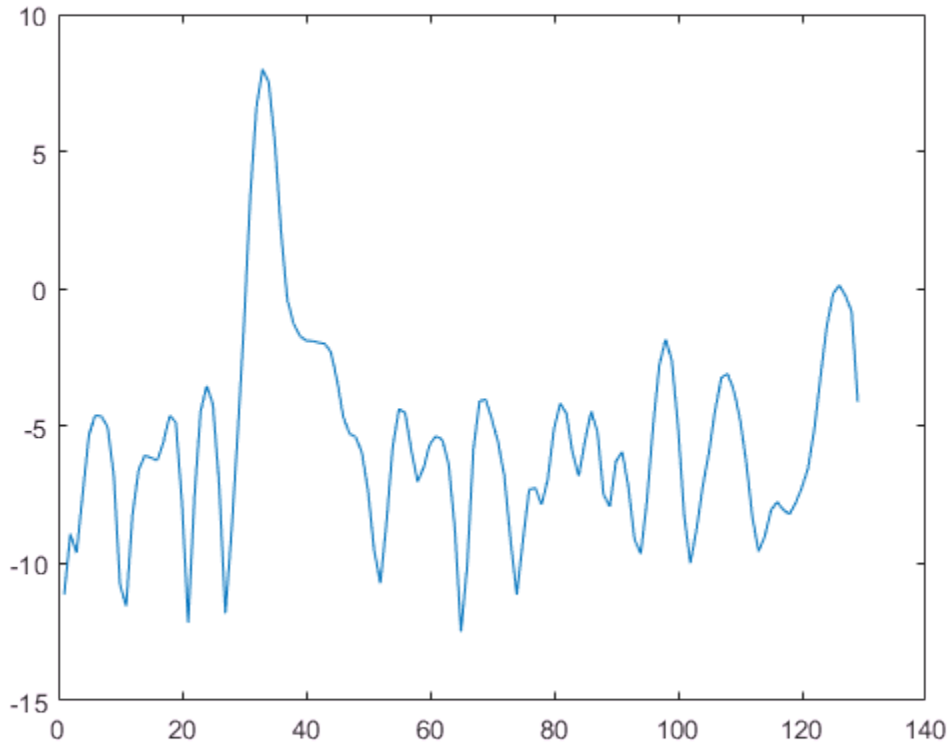

Welch Estimate Using Specified DFT Length

Obtain the Welch PSD estimate of an input signal consisting of a discrete-time sinusoid with an angular frequency of $\pi/4$ rad/sample with additive $N(0,1)$ white noise.

Create a sine wave with an angular frequency of $\pi/4$ rad/sample with additive $N(0,1)$ white noise. Reset the random number generator for reproducible results. The signal is 320 samples in length.

```
rng default
```

```
n = 0:319;
```

```
x = cos(pi/4*n)+randn(size(n));
```

Obtain the Welch PSD estimate dividing the signal into segments 100 samples in length. Use the default overlap of 50%. Specify the DFT length to be 640 points so that the

frequency of $\pi/4$ rad/sample corresponds to a DFT bin (bin 81). Because the signal is real-valued, the PSD estimate is one-sided and there are $640/2+1$ points.

```
segmentLength = 100;  
nfft = 640;  
pxx = pwelch(x,segmentLength,[],nfft);
```

```
plot(10*log10(pxx))  
xlabel('rad/sample')  
ylabel('dB')
```

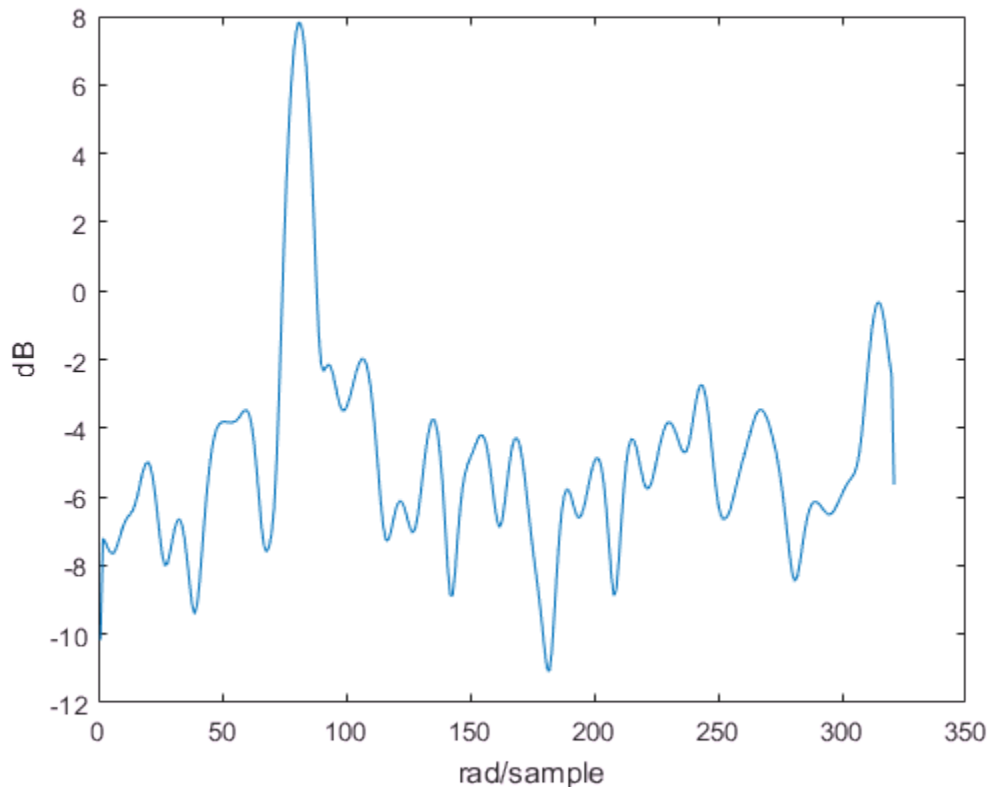

Welch PSD Estimate of Signal with Frequency in Hertz

Create a signal consisting of a 100 Hz sinusoid in additive $N(0, 1)$ white noise. Reset the random number generator for reproducible results. The sample rate is 1 kHz and the signal is 5 seconds in duration.

```
rng default

fs = 1000;
t = 0:1/fs:5-1/fs;
x = cos(2*pi*100*t)+randn(size(t));
```

Obtain Welch's overlapped segment averaging PSD estimate of the preceding signal. Use a segment length of 500 samples with 300 overlapped samples. Use 500 DFT points so that 100 Hz falls directly on a DFT bin. Input the sample rate to output a vector of frequencies in Hz. Plot the result.

```
[pxx,f] = pwelch(x,500,300,500,fs);

plot(f,10*log10(pxx))

xlabel('Frequency (Hz)')
ylabel('Magnitude (dB)')
```

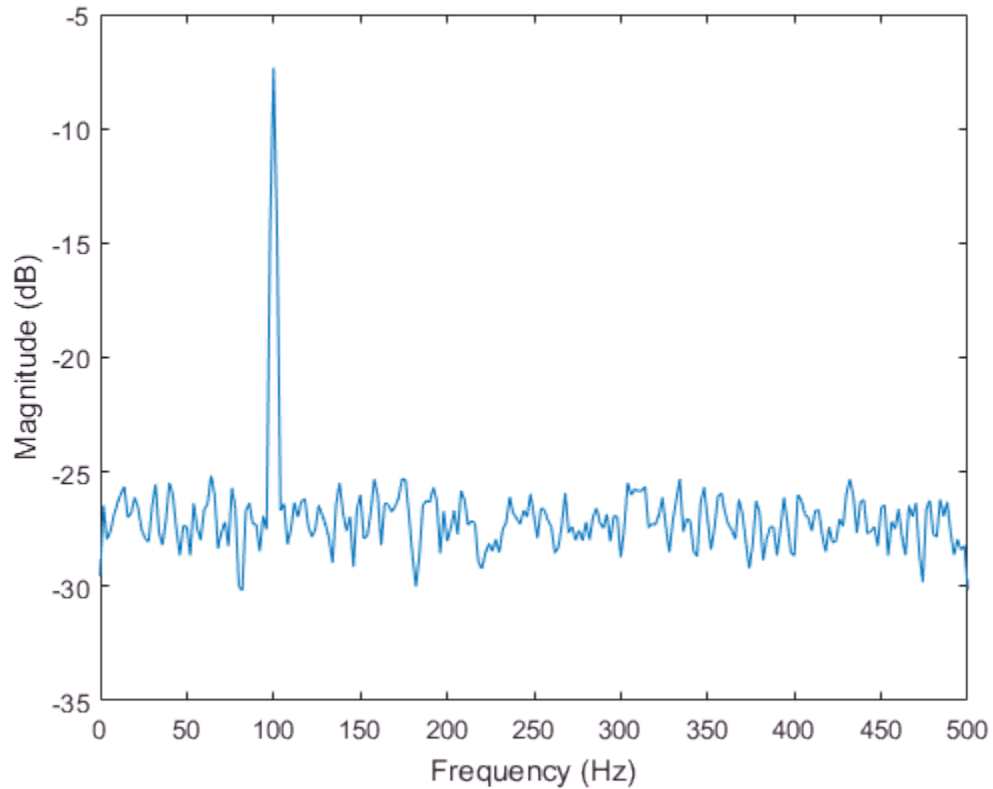
DC-Centered Power Spectrum

Create a signal consisting of a 100 Hz sinusoid in additive $N(0, 1/4)$ white noise. Reset the random number generator for reproducible results. The sample rate is 1 kHz and the signal is 5 seconds in duration.

```
rng default
```

```
fs = 1000;  
t = 0:1/fs:5-1/fs;
```

```
noisevar = 1/4;
x = cos(2*pi*100*t)+sqrt(noisevar)*randn(size(t));
```

Obtain the DC-centered power spectrum using Welch's method. Use a segment length of 500 samples with 300 overlapped samples and a DFT length of 500 points. Plot the result.

```
[pxx,f] = pwelch(x,500,300,500,fs,'centered','power');
plot(f,10*log10(pxx))
xlabel('Frequency (Hz)')
ylabel('Magnitude (dB)')
grid
```

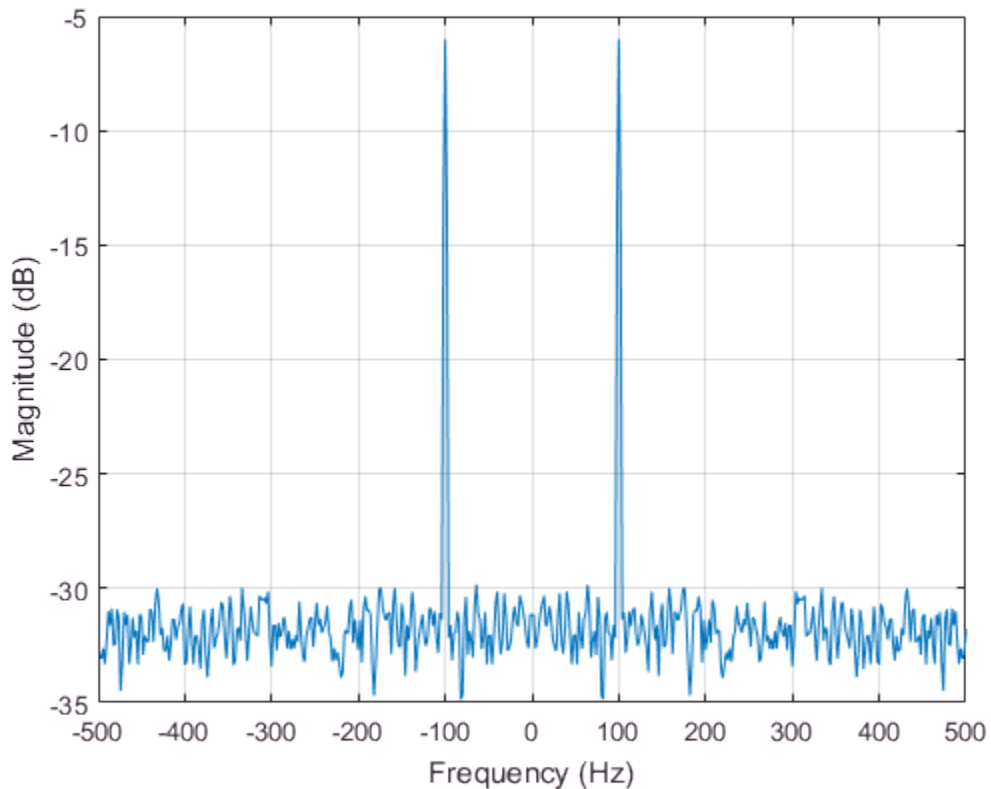

You see that the power at -100 and 100 Hz is close to the expected power of 1/4 for a real-valued sine wave with an amplitude of 1. The deviation from 1/4 is due to the effect of the additive noise.

Maximum-Hold and Minimum-Hold Spectra

Create a signal consisting of three noisy sinusoids and a chirp, sampled at 200 kHz for 0.1 second. The frequencies of the sinusoids are 1 kHz, 10 kHz, and 20 kHz. The sinusoids have different amplitudes and noise levels. The noiseless chirp has a frequency that starts at 20 kHz and increases linearly to 30 kHz during the sampling.

```
Fs = 200e3;
Fc = [1 10 20]'*1e3;
Ns = 0.1*Fs;

t = (0:Ns-1)/Fs;
x = [1 1/10 10]*sin(2*pi*Fc*t)+[1/200 1/2000 1/20]*randn(3,Ns);
x = x+chirp(t,20e3,t(end),30e3);
```

Compute the Welch PSD estimate and the maximum-hold and minimum-hold spectra of the signal. Plot the results.

```
[pxx,f] = pwelch(x,[],[],[],Fs);
pmax = pwelch(x,[],[],[],Fs,'maxhold');
pmin = pwelch(x,[],[],[],Fs,'minhold');

plot(f,pow2db(pxx))
hold on
plot(f,pow2db([pmax pmin]),':')
hold off
xlabel('Frequency (Hz)')
ylabel('PSD (dB/Hz)')
legend('pwelch','maxhold','minhold')
```

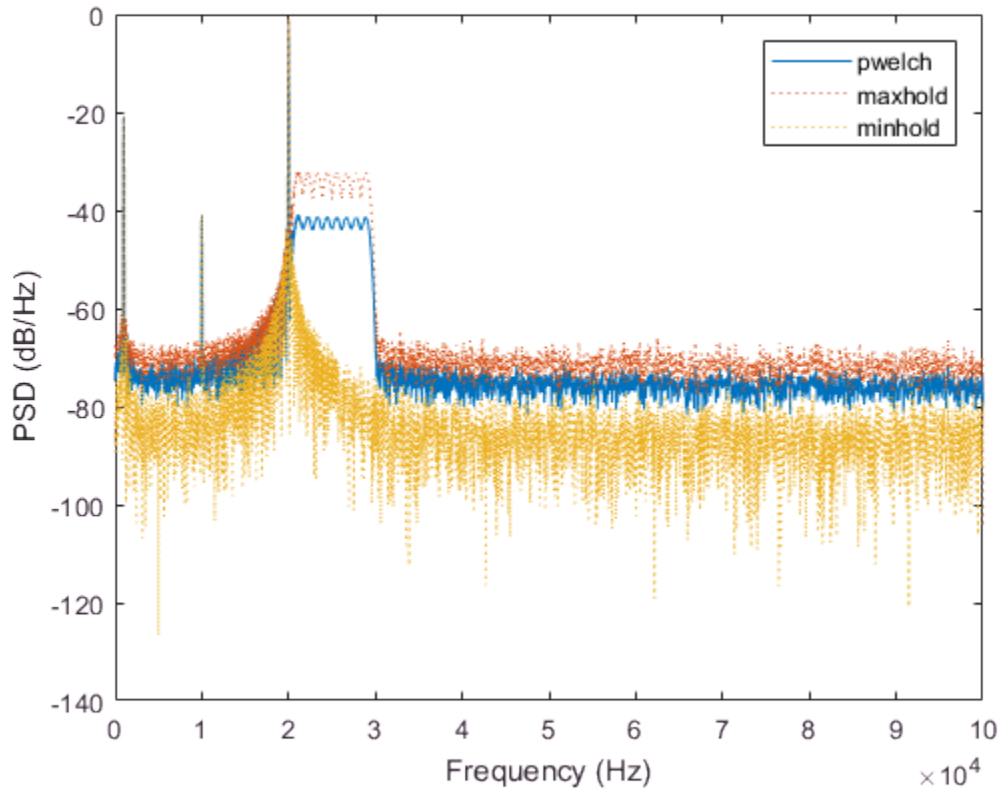

Repeat the procedure, this time computing centered power spectrum estimates.

```
[pxx,f] = pwelch(x,[],[],[],Fs,'centered','power');
pmax = pwelch(x,[],[],[],Fs,'maxhold','centered','power');
pmin = pwelch(x,[],[],[],Fs,'minhold','centered','power');

plot(f,pow2db(pxx))
hold on
plot(f,pow2db([pmax pmin]),':')
hold off
xlabel('Frequency (Hz)')
ylabel('Power (dB)')
legend('pwelch','maxhold','minhold')
```

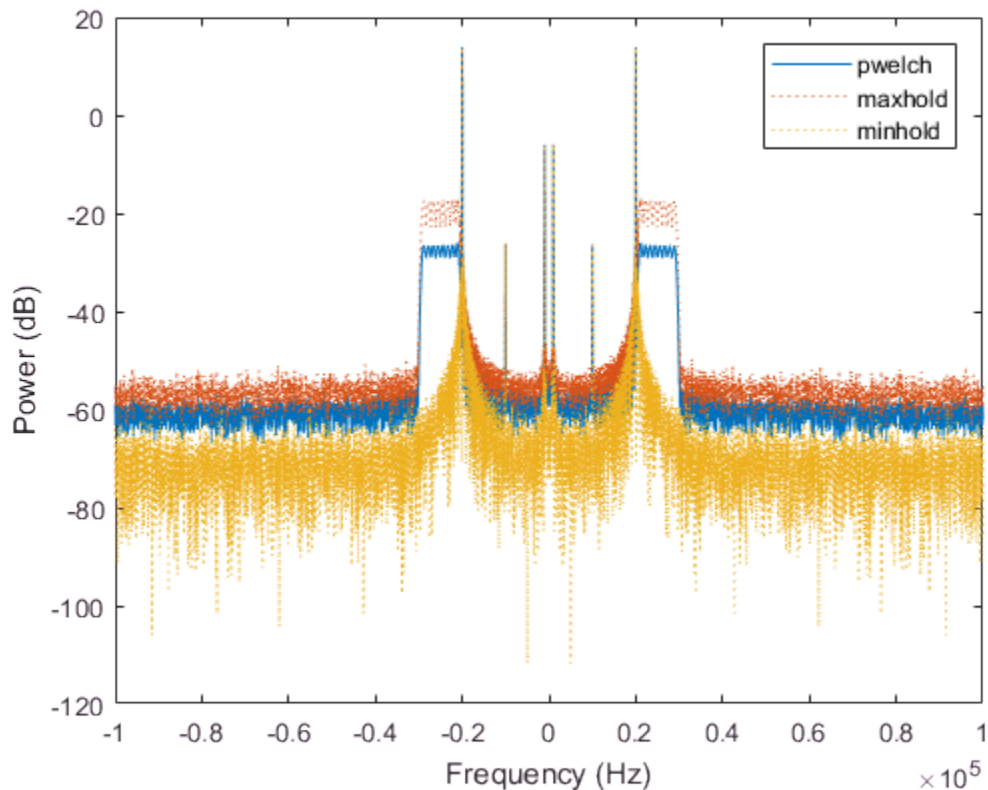

Upper and Lower 95%-Confidence Bounds

This example illustrates the use of confidence bounds with Welch's overlapped segment averaging (WOSA) PSD estimate. While not a necessary condition for statistical significance, frequencies in Welch's estimate where the lower confidence bound exceeds the upper confidence bound for surrounding PSD estimates clearly indicate significant oscillations in the time series.

Create a signal consisting of the superposition of 100 Hz and 150 Hz sine waves in additive white $N(0, 1)$ noise. The amplitude of the two sine waves is 1. The sample rate is 1 kHz. Reset the random number generator for reproducible results.

```
rng default
t = 0:0.001:1-0.001;
fs = 1000;
x = cos(2*pi*100*t)+sin(2*pi*150*t)+randn(size(t));
```

Obtain the WOSA estimate with 95%-confidence bounds. Set the segment length equal to 200 and overlap the segments by 50% (100 samples). Plot the WOSA PSD estimate along with the confidence interval and zoom in on the frequency region of interest near 100 and 150 Hz.

```
L = 200;
noverlap = 100;
[pxx,f,pxxc] = pwelch(x,hamming(L),noverlap,200,fs,...
    'ConfidenceLevel',0.95);

plot(f,10*log10(pxx))
hold on
plot(f,10*log10(pxxc),'r-.')

xlim([25 250])
xlabel('Frequency (Hz)')
ylabel('Magnitude (dB)')
title('Welch Estimate with 95%-Confidence Bounds')
```

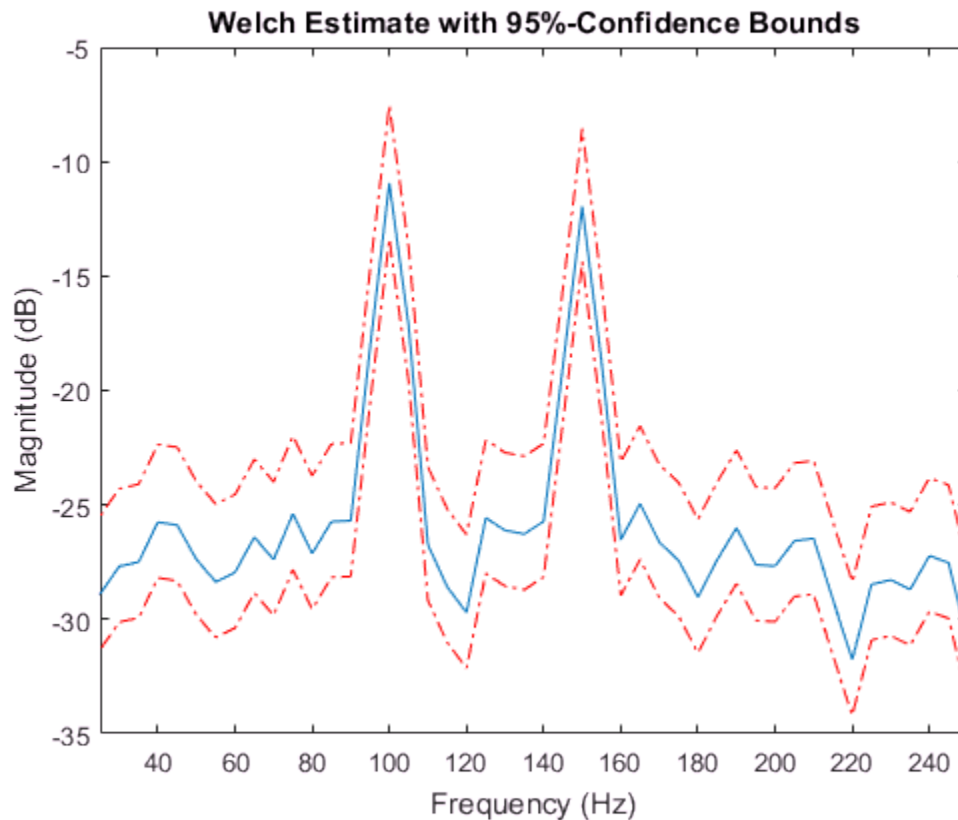

The lower confidence bound in the immediate vicinity of 100 and 150 Hz is significantly above the upper confidence bound outside the vicinity of 100 and 150 Hz.

Welch PSD Estimate of a Multichannel Signal

Generate 1024 samples of a multichannel signal consisting of three sinusoids in additive $N(0, 1)$ white Gaussian noise. The sinusoids' frequencies are $\pi/2$, $\pi/3$, and $\pi/4$ rad/sample. Estimate the PSD of the signal using Welch's method and plot it.

```
N = 1024;
n = 0:N-1;
```

```
w = pi./[2;3;4];  
x = cos(w*n)' + randn(length(n),3);  
  
pwelch(x)
```

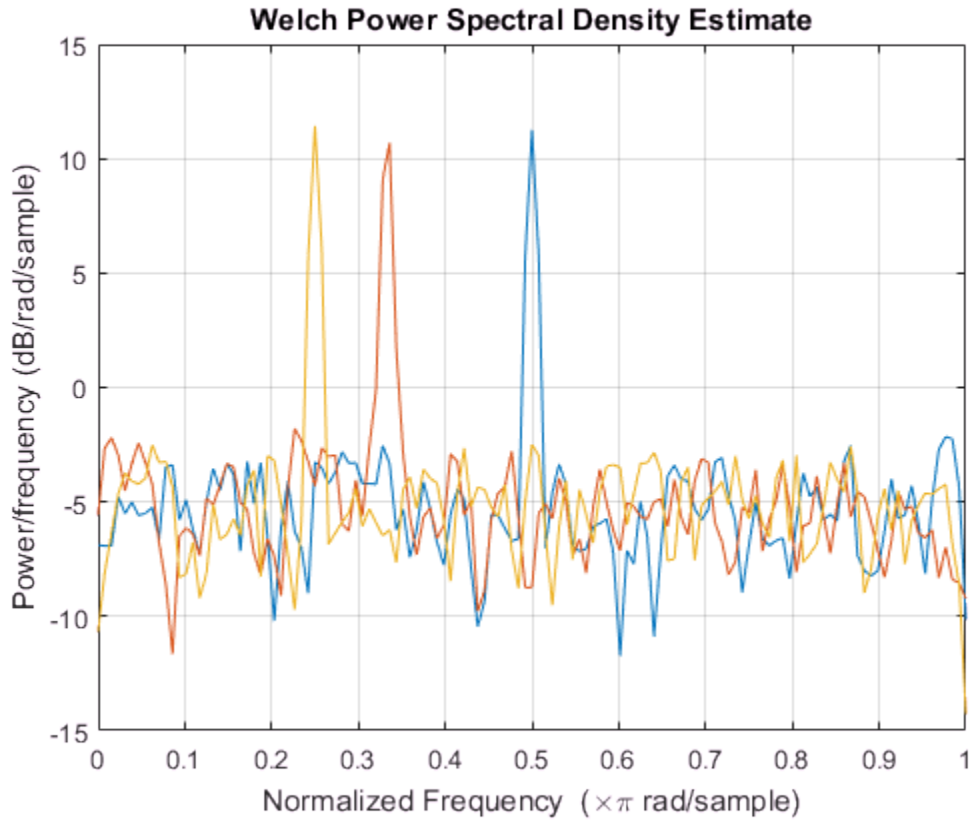

- “Bias and Variability in the Periodogram”

Input Arguments

x — Input signal
vector | matrix

Input signal, specified as a row or column vector, or as a matrix. If x is a matrix, then its columns are treated as independent channels.

Example: `cos(pi/4*(0:159))+randn(1,160)` is a single-channel row-vector signal.

Example: `cos(pi./[4;2]*(0:159))'+randn(160,2)` is a two-channel signal.

Data Types: `single` | `double`

Complex Number Support: Yes

window — Window

`integer` | `vector` | `[]`

Window, specified as a row or column vector or an integer. If `window` is a vector, `pwelch` divides x into overlapping segments of length equal to the length of `window`, and then multiplies each signal segment with the vector specified in `window`. If `window` is an integer, `pwelch` is divided into segments of length equal to the integer value, and a Hamming window of equal length is used. If the length of x cannot be divided exactly into an integer number of segments with `noverlap` number of overlapping samples, x is truncated accordingly. If you specify `window` as empty, the default Hamming window is used to obtain eight segments of x with `noverlap` overlapping samples.

Data Types: `single` | `double`

noverlap — Number of overlapped samples

`positive integer` | `[]`

Number of overlapped samples, specified as a positive integer smaller than the length of `window`. If you omit `noverlap` or specify `noverlap` as empty, a value is used to obtain 50% overlap between segments.

nfft — Number of DFT points

`max(256,2^nextpow2(length(window)))` (default) | `integer` | `[]`

Number of DFT points, specified as a positive integer. For a real-valued input signal, x , the PSD estimate, `pxx` has length $(nfft/2 + 1)$ if `nfft` is even, and $(nfft + 1)/2$ if `nfft` is odd. For a complex-valued input signal, x , the PSD estimate always has length `nfft`. If `nfft` is specified as empty, the default `nfft` is used.

If `nfft` is greater than the segment length, the data is zero-padded. If `nfft` is less than the segment length, the segment is wrapped using `datawrap` to make the length equal to `nfft`.

Data Types: `single` | `double`

fs — Sample rate

positive scalar

Sample rate, specified as a positive scalar. The sample rate is the number of samples per unit time. If the unit of time is seconds, then the sample rate has units of Hz.

w — Normalized frequencies

vector

Normalized frequencies, specified as a row or column vector with at least two elements. Normalized frequencies are in rad/sample.

Example: `w = [pi/4 pi/2]`

Data Types: double

f — Frequencies

vector

Frequencies, specified as a row or column vector with at least two elements. The frequencies are in cycles per unit time. The unit time is specified by the sample rate, `fs`. If `fs` has units of samples/second, then `f` has units of Hz.

Example: `fs = 1000; f = [100 200]`

Data Types: double

freqrang — Frequency range for PSD estimate

'onesided' | 'twosided' | 'centered'

Frequency range for the PSD estimate, specified as a one of 'onesided', 'twosided', or 'centered'. The default is 'onesided' for real-valued signals and 'twosided' for complex-valued signals. The frequency ranges corresponding to each option are

- 'onesided' — returns the one-sided PSD estimate of a real-valued input signal, `x`. If `nfft` is even, `pxx` has length `nfft/2 + 1` and is computed over the interval $[0, \pi]$ rad/sample. If `nfft` is odd, the length of `pxx` is $(nfft + 1)/2$ and the interval is $[0, \pi)$ rad/sample. When `fs` is optionally specified, the corresponding intervals are $[0, fs/2]$ cycles/unit time and $[0, fs/2)$ cycles/unit time for even and odd length `nfft` respectively.
- 'twosided' — returns the two-sided PSD estimate for either the real-valued or complex-valued input, `x`. In this case, `pxx` has length `nfft` and is computed over the interval $[0, 2\pi)$ rad/sample. When `fs` is optionally specified, the interval is $[0, fs)$ cycles/unit time.

- `'centered'` — returns the centered two-sided PSD estimate for either the real-valued or complex-valued input, `x`. In this case, `pxx` has length `nfft` and is computed over the interval $(-\pi, \pi]$ rad/sample for even length `nfft` and $(-\pi, \pi)$ rad/sample for odd length `nfft`. When `fs` is optionally specified, the corresponding intervals are $(-fs/2, fs/2]$ cycles/unit time and $(-fs/2, fs/2)$ cycles/unit time for even and odd length `nfft` respectively.

Data Types: char

spectrumtype — Power spectrum scaling

`'psd'` (default) | `'power'`

Power spectrum scaling, specified as one of `'psd'` or `'power'`. Omitting the `spectrumtype`, or specifying `'psd'`, returns the power spectral density. Specifying `'power'` scales each estimate of the PSD by the equivalent noise bandwidth of the window. Use the `'power'` option to obtain an estimate of the power at each frequency.

Data Types: char

trace — Trace mode

`'mean'` (default) | `'maxhold'` | `'minhold'`

Trace mode, specified as one of `'mean'`, `'maxhold'`, or `'minhold'`. The default is `'mean'`.

- `'mean'` — returns the Welch spectrum estimate of each input channel. `pwelch` computes the Welch spectrum estimate at each frequency bin by averaging the power spectrum estimates of all the segments.
- `'maxhold'` — returns the maximum-hold spectrum of each input channel. `pwelch` computes the maximum-hold spectrum at each frequency bin by keeping the maximum value among the power spectrum estimates of all the segments.
- `'minhold'` — returns the minimum-hold spectrum of each input channel. `pwelch` computes the minimum-hold spectrum at each frequency bin by keeping the minimum value among the power spectrum estimates of all the segments.

probability — Confidence interval for PSD estimate

0.95 (default) | scalar in the range (0,1)

Coverage probability for the true PSD, specified as a scalar in the range (0,1). The output, `pxxc`, contains the lower and upper bounds of the `probability` × 100% interval estimate for the true PSD.

Output Arguments

p_{xx} — PSD estimate

vector | matrix

PSD estimate, returned as a real-valued, nonnegative column vector or matrix. Each column of **p_{xx}** is the PSD estimate of the corresponding column of **x**. The units of the PSD estimate are in squared magnitude units of the time series data per unit frequency. For example, if the input data is in volts, the PSD estimate is in units of squared volts per unit frequency. For a time series in volts, if you assume a resistance of 1 Ω and specify the sample rate in hertz, the PSD estimate is in watts per hertz.

Data Types: `single` | `double`

w — Normalized frequencies

vector

Normalized frequencies, returned as a real-valued column vector. If **p_{xx}** is a one-sided PSD estimate, **w** spans the interval $[0, \pi]$ if `nfft` is even and $[0, \pi]$ if `nfft` is odd. If **p_{xx}** is a two-sided PSD estimate, **w** spans the interval $[0, 2\pi]$. For a DC-centered PSD estimate, **w** spans the interval $(-\pi, \pi]$ for even `nfft` and $(-\pi, \pi)$ for odd `nfft`.

Data Types: `double`

f — Cyclical frequencies

vector

Cyclical frequencies, returned as a real-valued column vector. For a one-sided PSD estimate, **f** spans the interval $[0, fs/2]$ when `nfft` is even and $[0, fs/2)$ when `nfft` is odd. For a two-sided PSD estimate, **f** spans the interval $[0, fs)$. For a DC-centered PSD estimate, **f** spans the interval $(-fs/2, fs/2]$ cycles/unit time for even length `nfft` and $(-fs/2, fs/2)$ cycles/unit time for odd length `nfft`.

Data Types: `double`

p_{xxc} — Confidence bounds

matrix

Confidence bounds, returned as a matrix with real-valued elements. The row size of the matrix is equal to the length of the PSD estimate, **p_{xx}**. **p_{xxc}** has twice as many columns as **p_{xx}**. Odd-numbered columns contain the lower bounds of the confidence intervals, and even-numbered columns contain the upper bounds. Thus, **p_{xxc}(m, 2*n - 1)** is the lower

confidence bound and $\text{pxxc}(m, 2*n)$ is the upper confidence bound corresponding to the estimate $\text{pxx}(m, n)$. The coverage probability of the confidence intervals is determined by the value of the `probability` input.

Data Types: `single` | `double`

Definitions

Welch's Overlapped Segment Averaging Spectral Estimation

The periodogram is not a consistent estimator of the true power spectral density of a wide-sense stationary process. Welch's technique to reduce the variance of the periodogram breaks the time series into segments, usually overlapping.

Welch's method computes a modified periodogram for each segment and then averages these estimates to produce the estimate of the power spectral density. Because the process is wide-sense stationary and Welch's method uses PSD estimates of different segments of the time series, the modified periodograms represent approximately uncorrelated estimates of the true PSD and averaging reduces the variability.

The segments are typically multiplied by a window function, such as a Hamming window, so that Welch's method amounts to averaging modified periodograms. Because the segments usually overlap, data values at the beginning and end of the segment tapered by the window in one segment, occur away from the ends of adjacent segments. This guards against the loss of information caused by windowing.

See Also

See Also

`periodogram` | `pmtm`

Topics

"Bias and Variability in the Periodogram"

"Spectral Analysis"

Introduced before R2006a

pyulear

Autoregressive power spectral density estimate — Yule-Walker method

Syntax

```
pxx = pyulear(x,order)
pxx = pyulear(x,order,nfft)

[pxx,w] = pyulear( ___ )
[pxx,f] = pyulear( ___,fs)

[pxx,w] = pyulear(x,order,w)
[pxx,f] = pyulear(x,order,f,fs)

[ ___ ] = pyulear(x,order, ___,freqrange)

[ ___,pxxc] = pyulear( ___, 'ConfidenceLevel',probability)

pyulear( ___ )
```

Description

`pxx = pyulear(x,order)` returns the power spectral density estimate, `pxx`, of a discrete-time signal, `x`, found using the Yule-Walker method. When `x` is a vector, it is treated as a single channel. When `x` is a matrix, the PSD is computed independently for each column and stored in the corresponding column of `pxx`. `pxx` is the distribution of power per unit frequency. The frequency is expressed in units of rad/sample. `order` is the order of the autoregressive (AR) model used to produce the PSD estimate.

`pxx = pyulear(x,order,nfft)` uses `nfft` points in the discrete Fourier transform (DFT). For real `x`, `pxx` has length $(nfft/2 + 1)$ if `nfft` is even, and $(nfft + 1)/2$ if `nfft` is odd. For complex-valued `x`, `pxx` always has length `nfft`. If you omit `nfft`, or specify it as empty, then `pyulear` uses a default DFT length of 256.

`[pxx,w] = pyulear(___)` returns the vector of normalized angular frequencies, `w`, at which the PSD is estimated. `w` has units of rad/sample. For real-valued signals, `w` spans the interval $[0,\pi]$ when `nfft` is even and $[0,\pi)$ when `nfft` is odd. For complex-valued signals, `w` always spans the interval $[0,2\pi)$.

`[pxx,f] = pyulear(____, fs)` returns a frequency vector, `f`, in cycles per unit time. The sampling frequency, `fs`, is the number of samples per unit time. If the unit of time is seconds, then `f` is in cycles/second (Hz). For real-valued signals, `f` spans the interval `[0,fs/2]` when `nfft` is even and `[0,fs/2)` when `nfft` is odd. For complex-valued signals, `f` spans the interval `[0,fs)`.

`[pxx,w] = pyulear(x,order,w)` returns the two-sided AR PSD estimates at the normalized frequencies specified in the vector, `w`. The vector, `w`, must contain at least two elements.

`[pxx,f] = pyulear(x,order,f,fs)` returns the two-sided AR PSD estimates at the frequencies specified in the vector, `f`. The vector, `f`, must contain at least two elements. The frequencies in `f` are in cycles per unit time. The sampling frequency, `fs`, is the number of samples per unit time. If the unit of time is seconds, then `f` is in cycles/second (Hz).

`[____] = pyulear(x,order, ____, freqrange)` returns the AR PSD estimate over the frequency range specified by `freqrange`. Valid options for `freqrange` are: 'onesided', 'twosided', or 'centered'.

`[____,pxxc] = pyulear(____, 'ConfidenceLevel',probability)` returns the `probability` × 100% confidence intervals for the PSD estimate in `pxxc`.

`pyulear(____)` with no output arguments plots the AR PSD estimate in dB per unit frequency in the current figure window.

Examples

Yule-Walker PSD Estimate of an AR(4) Process

Create a realization of an AR(4) wide-sense stationary random process. Estimate the PSD using the Yule-Walker method. Compare the PSD estimate based on a single realization to the true PSD of the random process.

Create an AR(4) system function. Obtain the frequency response and plot the PSD of the system.

```
A = [1 -2.7607 3.8106 -2.6535 0.9238];
[H,F] = freqz(1,A,[],1);
plot(F,20*log10(abs(H)))
```

```
xlabel('Frequency (Hz)')  
ylabel('PSD (dB/Hz)')
```

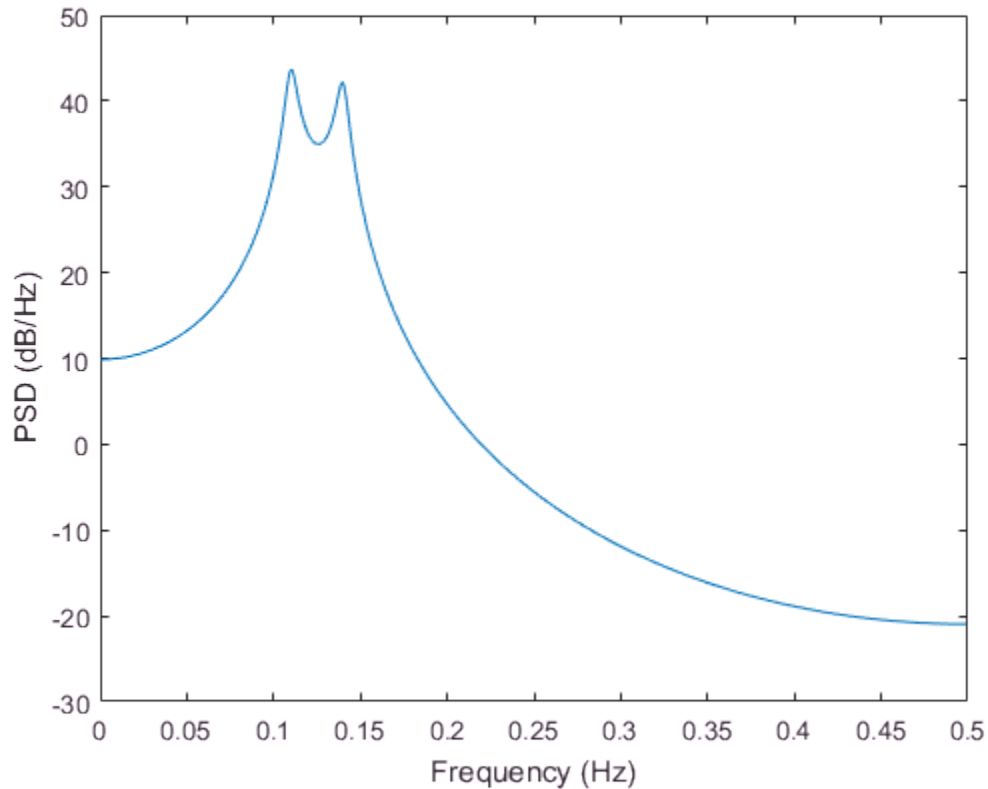

Create a realization of the AR(4) random process. Set the random number generator to the default settings for reproducible results. The realization is 1000 samples in length. Assume a sampling frequency of 1 Hz. Use `pyulear` to estimate the PSD for a 4th-order process. Compare the PSD estimate with the true PSD.

```
rng default  
  
x = randn(1000,1);  
y = filter(1,A,x);  
[Pxx,F] = pyulear(y,4,1024,1);
```



```

hold on
plot(F,10*log10(Pxx))
legend('True Power Spectral Density','pyulear PSD Estimate')

```

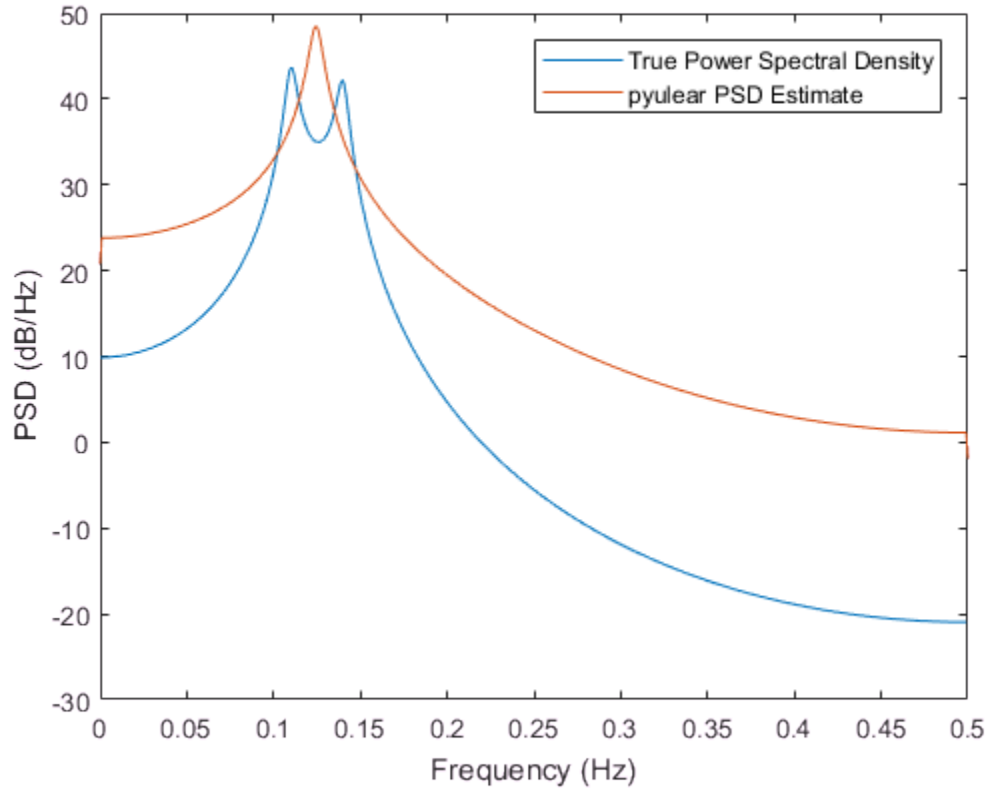

Yule-Walker PSD Estimate of a Multichannel Signal

Create a multichannel signal consisting of three sinusoids in additive $N(0, 1)$ white Gaussian noise. The sinusoids' frequencies are 100 Hz, 200 Hz, and 300 Hz. The sampling frequency is 1 kHz, and the signal has a duration of 1 s.

```
Fs = 1000;
```

```
t = 0:1/Fs:1-1/Fs;  
f = [100;200;300];  
x = cos(2*pi*f*t)' + randn(length(t),3);
```

Estimate the PSD of the signal using the Yule-Walker method with a 12th-order autoregressive model. Use the default DFT length. Plot the estimate.

```
morder = 12;  
pyulear(x,morder,[],Fs)
```

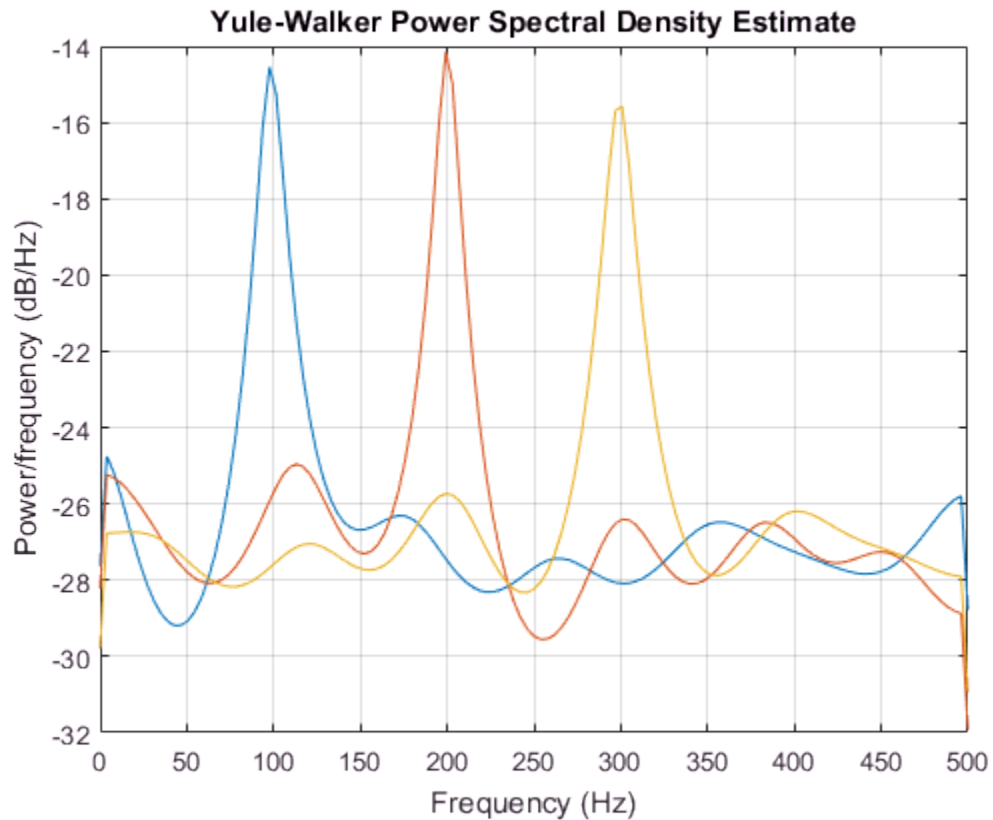

Input Arguments

x — Input signal

vector | matrix

Input signal, specified as a row or column vector, or as a matrix. If **x** is a matrix, then its columns are treated as independent channels.

Example: `cos(pi/4*(0:159))+randn(1,160)` is a single-channel row-vector signal.

Example: `cos(pi./[4;2]*(0:159))'+randn(160,2)` is a two-channel signal.

Data Types: `single` | `double`

Complex Number Support: Yes

order — Order of autoregressive model

positive integer

Order of the autoregressive model, specified as a positive integer.

Data Types: `double`

nfft — Number of DFT points

256 (default) | integer | []

Number of DFT points, specified as a positive integer. For a real-valued input signal, **x**, the PSD estimate, **pxx** has length $(nfft/2+1)$ if **nfft** is even, and $(nfft+1)/2$ if **nfft** is odd. For a complex-valued input signal, **x**, the PSD estimate always has length **nfft**. If **nfft** is specified as empty, the default **nfft** is used.

Data Types: `single` | `double`

fs — Sample rate

positive scalar

Sample rate, specified as a positive scalar. The sample rate is the number of samples per unit time. If the unit of time is seconds, then the sample rate has units of Hz.

w — Normalized frequencies

vector

Normalized frequencies, specified as a row or column vector with at least two elements. Normalized frequencies are in rad/sample.

Example: `w = [pi/4 pi/2]`

Data Types: double

f — Frequencies

vector

Frequencies, specified as a row or column vector with at least two elements. The frequencies are in cycles per unit time. The unit time is specified by the sample rate, `fs`. If `fs` has units of samples/second, then `f` has units of Hz.

Example: `fs = 1000; f = [100 200]`

Data Types: double

freqrang — Frequency range for PSD estimate

'onesided' | 'twosided' | 'centered'

Frequency range for the PSD estimate, specified as a one of 'onesided', 'twosided', or 'centered'. The default is 'onesided' for real-valued signals and 'twosided' for complex-valued signals. The frequency ranges corresponding to each option are

- 'onesided' — returns the one-sided PSD estimate of a real-valued input signal, `x`. If `nfft` is even, `pxx` has length $nfft/2 + 1$ and is computed over the interval $[0, \pi]$ rad/sample. If `nfft` is odd, the length of `pxx` is $(nfft + 1)/2$ and the interval is $[0, \pi)$ rad/sample. When `fs` is optionally specified, the corresponding intervals are $[0, fs/2]$ cycles/unit time and $[0, fs/2)$ cycles/unit time for even and odd length `nfft` respectively.
- 'twosided' — returns the two-sided PSD estimate for either the real-valued or complex-valued input, `x`. In this case, `pxx` has length `nfft` and is computed over the interval $[0, 2\pi)$ rad/sample. When `fs` is optionally specified, the interval is $[0, fs)$ cycles/unit time.
- 'centered' — returns the centered two-sided PSD estimate for either the real-valued or complex-valued input, `x`. In this case, `pxx` has length `nfft` and is computed over the interval $(-\pi, \pi]$ rad/sample for even length `nfft` and $(-\pi, \pi)$ rad/sample for odd length `nfft`. When `fs` is optionally specified, the corresponding intervals are $(-fs/2, fs/2]$ cycles/unit time and $(-fs/2, fs/2)$ cycles/unit time for even and odd length `nfft` respectively.

Data Types: char

probability — Confidence interval for PSD estimate

0.95 (default) | scalar in the range (0,1)

Coverage probability for the true PSD, specified as a scalar in the range (0,1). The output, `pxxc`, contains the lower and upper bounds of the `probability × 100%` interval estimate for the true PSD.

Output Arguments

pxx — PSD estimate

vector | matrix

PSD estimate, returned as a real-valued, nonnegative column vector or matrix. Each column of `pxx` is the PSD estimate of the corresponding column of `x`. The units of the PSD estimate are in squared magnitude units of the time series data per unit frequency. For example, if the input data is in volts, the PSD estimate is in units of squared volts per unit frequency. For a time series in volts, if you assume a resistance of 1Ω and specify the sample rate in hertz, the PSD estimate is in watts per hertz.

Data Types: `single` | `double`

w — Normalized frequencies

vector

Normalized frequencies, returned as a real-valued column vector. If `pxx` is a one-sided PSD estimate, `w` spans the interval $[0, \pi]$ if `nfft` is even and $[0, \pi)$ if `nfft` is odd. If `pxx` is a two-sided PSD estimate, `w` spans the interval $[0, 2\pi)$. For a DC-centered PSD estimate, `w` spans the interval $(-\pi, \pi]$ for even `nfft` and $(-\pi, \pi)$ for odd `nfft`.

Data Types: `double`

f — Cyclical frequencies

vector

Cyclical frequencies, returned as a real-valued column vector. For a one-sided PSD estimate, `f` spans the interval $[0, fs/2]$ when `nfft` is even and $[0, fs/2)$ when `nfft` is odd. For a two-sided PSD estimate, `f` spans the interval $[0, fs)$. For a DC-centered PSD estimate, `f` spans the interval $(-fs/2, fs/2]$ cycles/unit time for even length `nfft` and $(-fs/2, fs/2)$ cycles/unit time for odd length `nfft`.

Data Types: `double`

pxxc — Confidence bounds

matrix

Confidence bounds, returned as a matrix with real-valued elements. The row size of the matrix is equal to the length of the PSD estimate, `pxx`. `pxxc` has twice as many columns as `pxx`. Odd-numbered columns contain the lower bounds of the confidence intervals, and even-numbered columns contain the upper bounds. Thus, `pxxc(m, 2*n - 1)` is the lower confidence bound and `pxxc(m, 2*n)` is the upper confidence bound corresponding to the estimate `pxx(m, n)`. The coverage probability of the confidence intervals is determined by the value of the `probability` input.

Data Types: `single` | `double`

See Also

See Also

`pburg` | `pcov` | `pmcov`

Introduced before R2006a

realizemdl

Simulink subsystem block for filter

Syntax

```
realizemdl(FilterObject)
realizemdl(FilterObject,Name,Value)
```

Description

`realizemdl(FilterObject)` generates a model of the filter object `FilterObject` in a Simulink subsystem block using sum, gain, and delay blocks from Simulink. The properties and values of `FilterObject` define the resulting subsystem block parameters.

`realizemdl` requires Simulink. To accurately realize models of quantized filters, use Fixed-Point Designer.

`realizemdl(FilterObject,Name,Value)` generates the model for `FilterObject` with the associated `Name,Value` pairs, and any other values you set in `FilterObject`.

Note Subsystem filter blocks that you use `realizemdl` to create support sample-based input and output only. You cannot input or output frame-based signals with the block.

Using the optional `propertyname/propertyvalue` pairs lets you control more fully the way the block subsystem model gets built, such as where the block goes, what the name is, or how to optimize the block structure. Valid properties and values for `realizemdl` are listed in this table, with the default value noted and descriptions of what the properties do.

Property Name	Property Values	Description
Destination	'current' (default), 'new' or <i>SubsystemName</i>	Specify whether to add the block to your current Simulink model or create a new model to contain the block. If you provide the name of a current

Property Name	Property Values	Description
		subsystem in <i>SubsystemName</i> , <code>realizemdl</code> adds the new block to the specified subsystem.
Blockname	'filter' (default)	Provides the name for the new subsystem block. By default the block is named 'filter'. To enter a name for the block, set <code>propertyvalue</code> to the name of your choice, enclosed in single quotes.
MapCoeffstoPorts	'off' (default) or 'on'	Specify whether to map the coefficients of the filter to the ports of the block.
MapStates	'off' (default) or 'on'	Specifies whether to apply the current filter states to the realized model. This lets you save states from a filter object you may have used or configured in a specific way. The default setting of 'off' means the states are not transferred to the model. Setting the property to 'on' preserves the current filter states in the realized model.
OverwriteBlock	'off' or 'on'	Specify whether to overwrite an existing block with the same name or create a new block.
OptimizeZeros	'off' (default) or 'on'	Specify whether to remove zero-gain blocks.
OptimizeOnes	'off' (default) or 'on'	Specify whether to replace unity-gain blocks with direct connections.

Property Name	Property Values	Description
OptimizeNegOnes	'off' (default) or 'on'	Specify whether to replace negative unity-gain blocks with a sign change at the nearest sum block.
OptimizeDelayChains	'off' (default) or 'on'	Specify whether to replace cascaded chains of delay blocks with a single integer delay block to provide an equivalent delay.
CoeffNames	{ 'Num' } (default FIR), { 'Num', 'Den' } (default direct form IIR), { 'Num', 'Den', 'g' } (default IIR SOS), { 'K' } (default form lattice)	Specify the coefficient variable names as character vectors in a cell array. <code>MapCoeffsToPorts</code> must be set to 'on' for this property to apply.
InputProcessing	'columnsaschannels' (default), 'elementsaschannels', or 'inherited'	Specify frame-based ('columnsaschannels') or sample-based ('elementsaschannels') processing. The Inherited (this choice will be removed - see release notes) option will be removed in a future release.
RateOption	'enforcesinglerate' (default) or 'allowmultirate'	Specify how the block adjusts the rate at the output to accommodate the reduced number of samples. This parameter applies only when <code>InputProcessing</code> is 'columnsaschannels'.

Examples

Model of Lowpass Butterworth Filter

Create a lowpass Butterworth filter and realize its Simulink® model with coefficients mapped to ports. Call the filter `NewFilter`.

```
[b,a] = butter(4,.25);  
d = dfilt.df1(b,a);  
realizemdl(d, 'MapCoeffsToPorts', 'on', 'BlockName', 'NewFilter')
```



In this case, the filter is an IIR filter with a direct form II second-order sections structure. Setting `MapCoeffstoPorts` to `'on'` exports the numerator coefficients, the denominator coefficients, and the gains to the MATLAB® workspace using the default variable names `Num`, `Den`, and `g`. Each column of `Num` and `Den` represents one second-order section. You can modify the filter coefficients directly in the MATLAB workspace providing tunability to the realized Simulink model.

See Also

See Also

Apps

Filter Designer

Functions

`designfilt` | `fdesign` | `filt2block`

Introduced in R2009b

rc2ac

Convert reflection coefficients to autocorrelation sequence

Syntax

```
r = rc2ac(k,r0)
```

Description

`r = rc2ac(k,r0)` finds the autocorrelation coefficients, `r`, of the output of the discrete-time prediction error filter from the lattice-form reflection coefficients `k` and initial zero-lag autocorrelation `r0`.

Examples

Compute Autocorrelation Sequence

Determine the autocorrelation sequence that corresponds to a given vector, `k`, of reflection coefficients and an initial zero-lag autocorrelation given by `r0`.

```
k = [0.3090 0.9800 0.0031 0.0082 -0.0082];  
r0 = 0.1;  
a = rc2ac(k,r0)
```

```
a =
```

```
    0.1000  
   -0.0309  
   -0.0791  
    0.0787  
    0.0294  
   -0.0950
```

References

- [1] Kay, Steven M. *Modern Spectral Estimation*. Englewood Cliffs, NJ: Prentice-Hall, 1988.

See Also

ac2rc | poly2ac | rc2poly

Introduced before R2006a

rc2is

Convert reflection coefficients to inverse sine parameters

Syntax

```
isin = rc2is(k)
```

Description

`isin = rc2is(k)` returns a vector of inverse sine parameters, `isin`, from a vector of reflection coefficients, `k`.

Examples

Compute Inverse Sine Parameters

Define a vector, `k`, of reflection coefficients and determine the corresponding inverse sine parameters.

```
k = [0.3090 0.9801 0.0031 0.0082 -0.0082];
```

```
isin = rc2is(k)
```

```
isin =
```

```
    0.2000    0.8728    0.0020    0.0052   -0.0052
```

References

- [1] Deller, John R., John G. Proakis, and John H. L. Hansen. *Discrete-Time Processing of Speech Signals*. New York: Macmillan, 1993.

See Also

`is2rc`

Introduced before R2006a

rc2lar

Convert reflection coefficients to log area ratio parameters

Syntax

```
g = rc2lar(k)
```

Description

`g = rc2lar(k)` returns a vector of log area ratio parameters `g` from a vector of reflection coefficients `k`.

Examples

Log Area Ratio Parameters

Define a vector, `k`, of reflection coefficients and compute the log area ratio parameters.

```
k = [0.3090 0.9801 0.0031 0.0082 -0.0082];
```

```
g = rc2lar(k)
```

```
g =
```

```
    0.6389    4.6002    0.0062    0.0164   -0.0164
```

References

- [1] Deller, John R., John G. Proakis, and John H. L. Hansen. *Discrete-Time Processing of Speech Signals*. New York: Macmillan, 1993.

See Also

lar2rc

Introduced before R2006a

rc2poly

Convert reflection coefficients to prediction filter polynomial

Syntax

```
a = rc2poly(k)
[a,efinal] = rc2poly(k,r0)
```

Description

`a = rc2poly(k)` converts the reflection coefficients `k` corresponding to the lattice structure to the prediction filter polynomial `a`, with `a(1) = 1`. The output `a` is row vector of length `length(k) + 1`.

`[a,efinal] = rc2poly(k,r0)` returns the final prediction error `efinal` based on the zero-lag autocorrelation, `r0`.

Examples

Equivalent Prediction Filter Representation

Consider a lattice IIR filter given by a set of reflection coefficients. Find its equivalent prediction filter representation.

```
k = [0.3090 0.9800 0.0031 0.0082 -0.0082];
```

```
a = rc2poly(k)
```

```
a =
```

```
    1.0000    0.6148    0.9899    0.0000    0.0032   -0.0082
```

Algorithms

`rc2poly` computes output `a` using Levinson's recursion [1]. The function

- 1** Sets the output vector `a` to the first element of `k`.
- 2** Loops through the remaining elements of `k`.
For each loop iteration `i`, `a = [a + a(i-1:-1:1)*k(i) k(i)]`.
- 3** Implements `a = [1 a]`.

References

- [1] Kay, Steven M. *Modern Spectral Estimation*. Englewood Cliffs, NJ: Prentice-Hall, 1988.

See Also

`ac2poly` | `latc2tf` | `latcfilt` | `poly2rc` | `rc2ac` | `rc2is` | `rc2lar` | `tf2latc`

Introduced before R2006a

rceps

Real cepstrum and minimum phase reconstruction

Syntax

```
rceps(x)  
[y,ym] = rceps(x)
```

Description

The *real cepstrum* is the inverse Fourier transform of the real logarithm of the magnitude of the Fourier transform of a sequence.

Note rceps only works on real data.

rceps(x) returns the real cepstrum of the real sequence x. The real cepstrum is a real-valued function.

[y,ym] = rceps(x) returns both the real cepstrum y and a minimum phase reconstructed version ym of the input sequence.

Examples

Echo Cancelation Using the Real Cepstrum

A speech recording includes an echo caused by reflection off a wall. Use the real cepstrum to filter it out.

In the recording, a person says the word MATLAB®. Load the data and the sample rate, $F_s = 7418$ Hz.

```
load mtlb
```

```
% To hear, type soundsc(mtlb,Fs)
```

Model the echo by adding to the recording a copy of the signal delayed by Δ samples and attenuated by a known factor α : $y(n) = x(n) + \alpha x(n - \Delta)$. Specify a time lag of 0.23 s and an attenuation factor of 0.5.

```
timelag = 0.23;
delta = round(Fs*timelag);
alpha = 0.5;

orig = [mtlb;zeros(delta,1)];
echo = [zeros(delta,1);mtlb]*alpha;

mtEcho = orig + echo;
```

Plot the original, the echo, and the resulting signal.

```
t = (0:length(mtEcho)-1)/Fs;

subplot(2,1,1)
plot(t,[orig echo])
legend('Original','Echo')

subplot(2,1,2)
plot(t,mtEcho)
legend('Total')
xlabel('Time (s)')
```

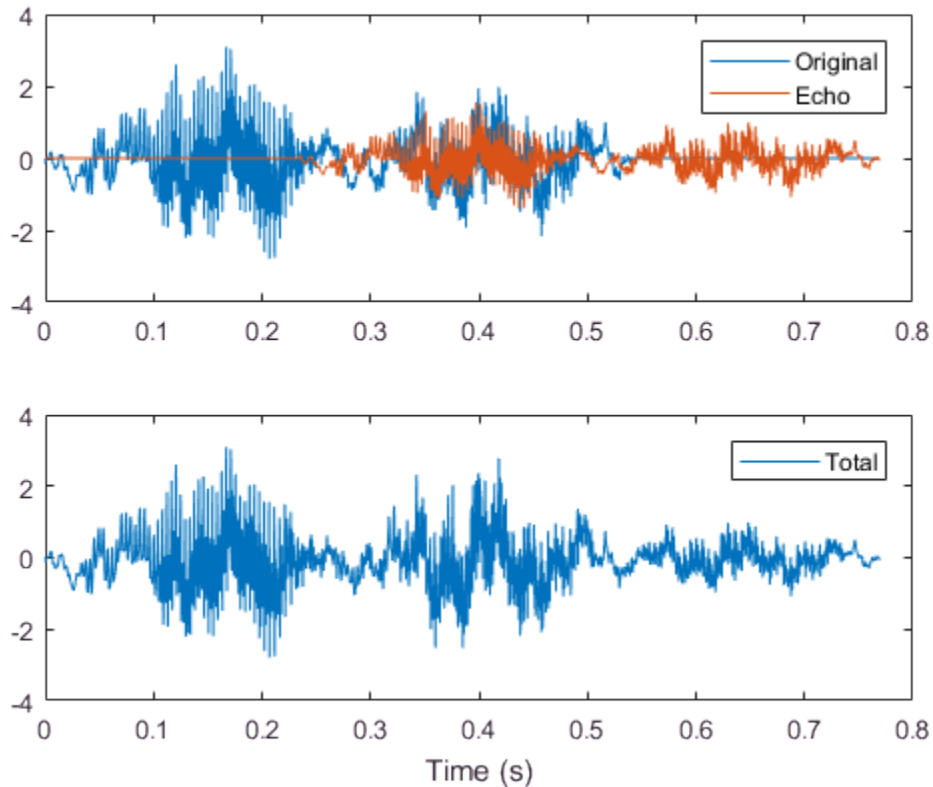

```
% To hear, type soundsc(mtEcho,Fs)
```

Compute the real cepstrum of the signal. Plot the cepstrum and annotate its maxima. The cepstrum has a sharp peak at the time at which the echo starts to arrive.

```
c = rceps(mtEcho);
[px,locs] = findpeaks(c,'Threshold',0.2,'MinPeakDistance',0.2);
clf
plot(t,c,t(locs),px,'o')
xlabel('Time (s)')
```

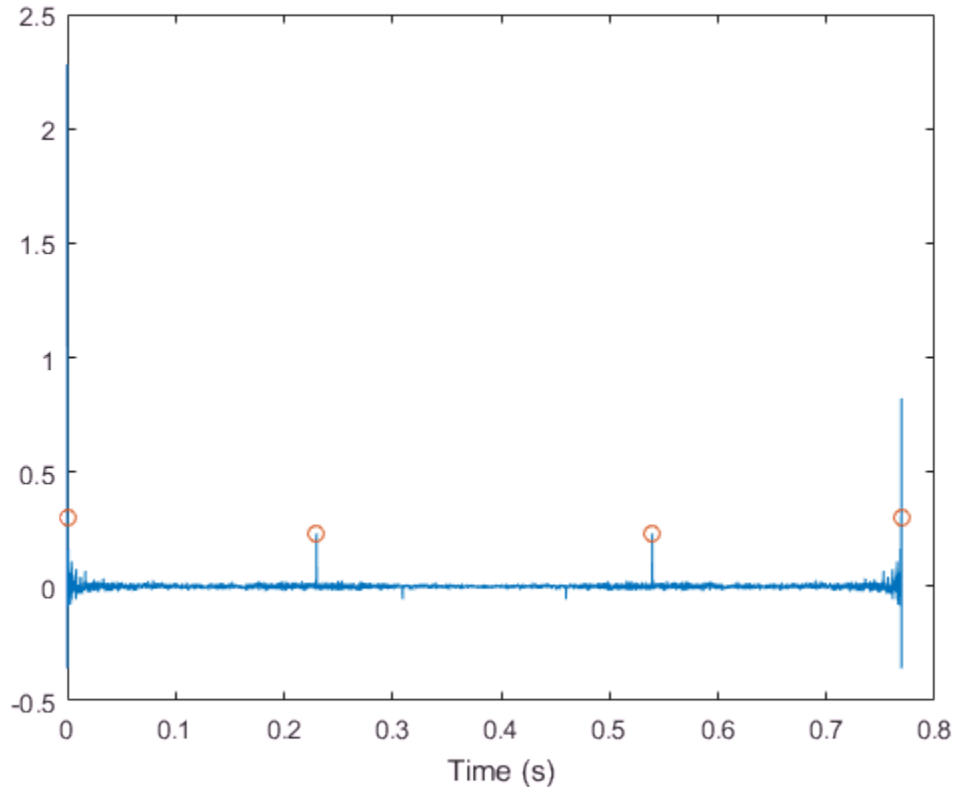

Cancel the echo by filtering the signal through an IIR system whose output, w , obeys $w(n) + \alpha w(n - \Delta) = y(n)$. Plot the filtered signal and compare it to the original.

```
d1 = locs(2) - 1;

mtNew = filter(1, [1 zeros(1, d1 - 1) alpha], mtEcho);

subplot(2, 1, 1)
plot(t, orig)
legend('Original')

subplot(2, 1, 2)
plot(t, mtNew)
```

```
legend('Filtered')  
xlabel('Time (s)')
```

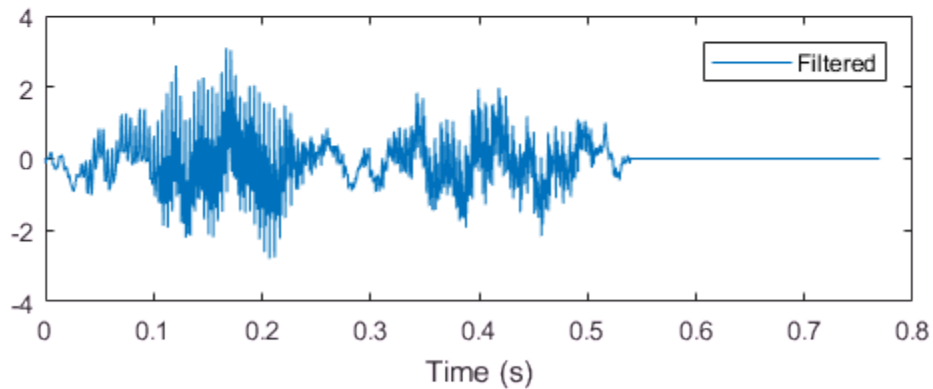
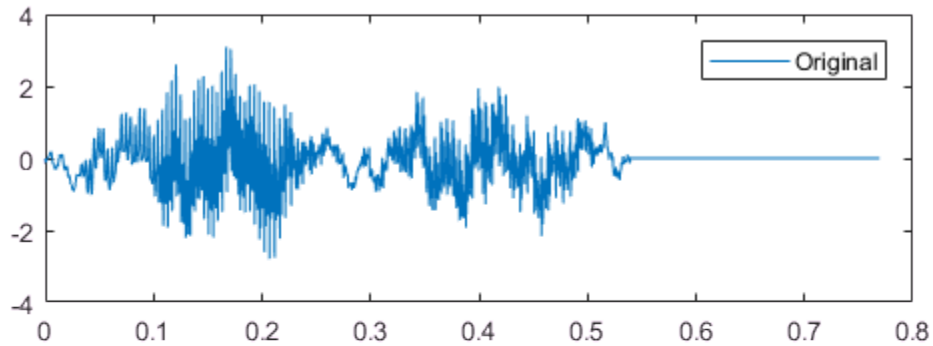

```
% To hear, type soundsc(mtNew,Fs)
```

Algorithms

rceps is an implementation of algorithm 7.2 in [2], that is,

```
y = real(ifft(log(abs(fft(x)))));
```

Appropriate windowing in the cepstral domain forms the reconstructed minimum phase signal:

```
w = [1;2*ones(n/2-1,1);ones(1-rem(n,2),1);zeros(n/2-1,1)];  
ym = real(ifft(exp(fft(w.*y))));
```

References

[1] Oppenheim, Alan V., and Ronald W. Schaffer. *Digital Signal Processing*, Englewood Cliffs, NJ, Prentice-Hall, 1975.

[2] *Programs for Digital Signal Processing*, IEEE Press, New York, 1979.

See Also

See Also

cceps | fft | hilbert | icceps | unwrap

Introduced before R2006a

rcosdesign

Raised cosine FIR pulse-shaping filter design

Syntax

```
b = rcosdesign(beta,span,sps)
b = rcosdesign(beta,span,sps,shape)
```

Description

`b = rcosdesign(beta,span,sps)` returns the coefficients, `b`, that correspond to a square-root raised cosine FIR filter with rolloff factor specified by `beta`. The filter is truncated to `span` symbols, and each symbol period contains `sps` samples. The order of the filter, `sps*span`, must be even. The filter energy is 1.

`b = rcosdesign(beta,span,sps,shape)` returns a square-root raised cosine filter when you set `shape` to `'sqrt'` and a normal raised cosine FIR filter when you set `shape` to `'normal'`.

Examples

Design a Square-Root Raised Cosine Filter

Specify a rolloff factor of 0.25. Truncate the filter to 6 symbols and represent each symbol with 4 samples. Verify that `'sqrt'` is the default value of the `shape` parameter.

```
h = rcosdesign(0.25,6,4);
mx = max(abs(h-rcosdesign(0.25,6,4,'sqrt'))))

mx = 0

fvtool(h,'Analysis','impulse')
```

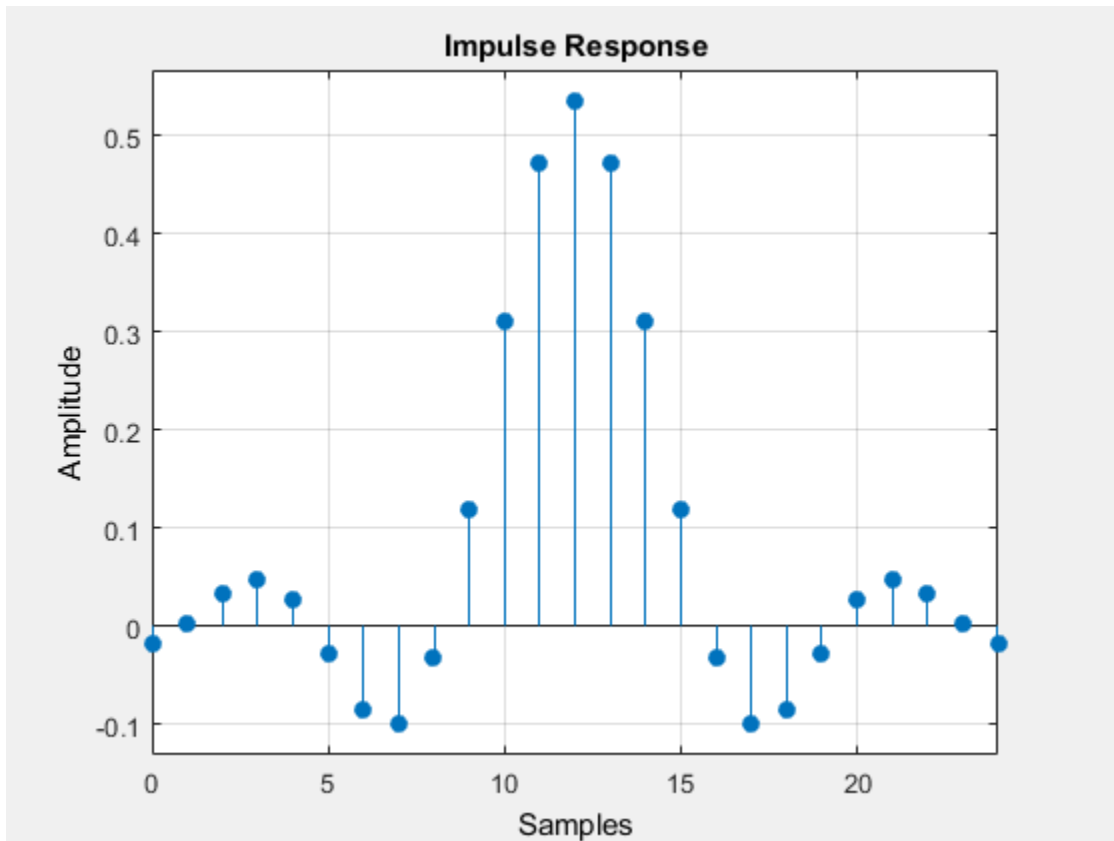

Impulse Responses of Normal and Square-Root Raised Cosine Filters

Compare a normal raised cosine filter with a square-root cosine filter. An ideal (infinite-length) normal raised cosine pulse-shaping filter is equivalent to two ideal square-root raised cosine filters in cascade. Thus, the impulse response of an FIR normal filter should resemble that of a square-root filter convolved with itself.

Create a normal raised cosine filter with rolloff 0.25. Specify that this filter span 4 symbols with 3 samples per symbol.

```
rf = 0.25;
span = 4;
```

```
sps = 3;  
  
h1 = rcosdesign(rf,span,sps,'normal');  
fvtool(h1,'impulse')
```

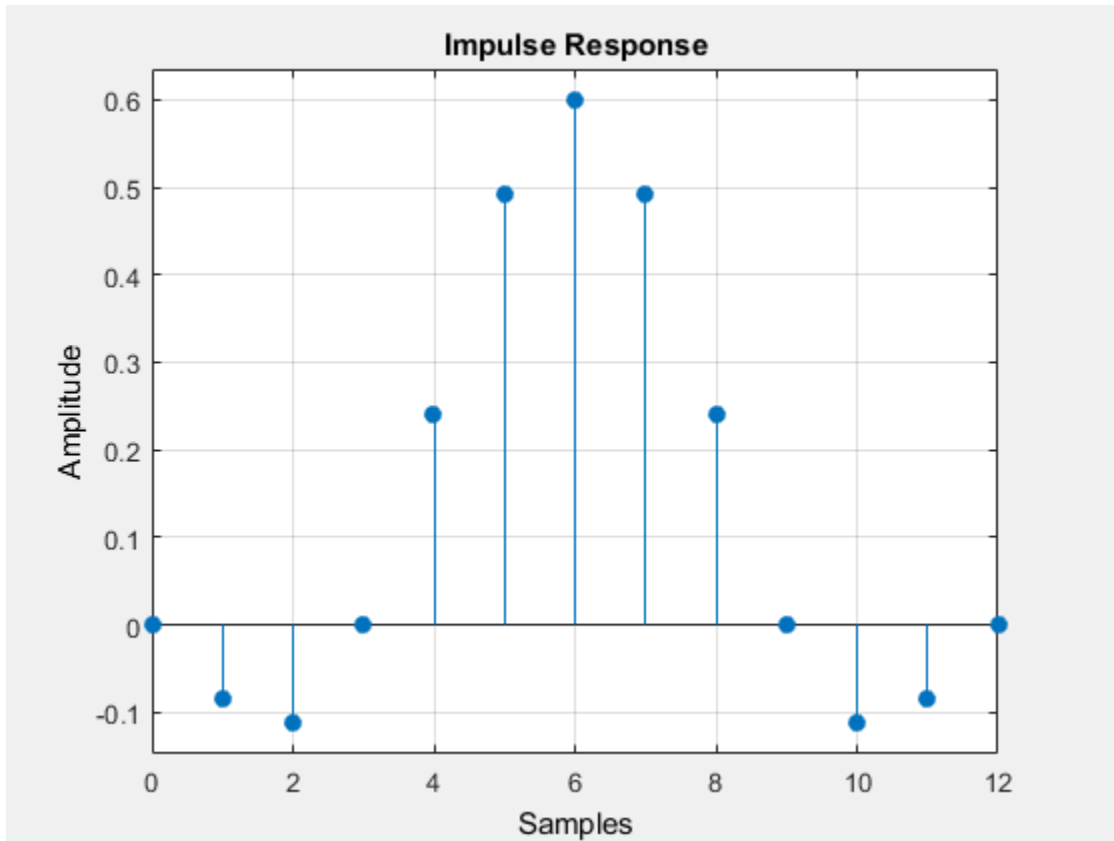

The normal filter has zero crossings at integer multiples of `sps`. It thus satisfies Nyquist's criterion for zero intersymbol interference. The square-root filter, however, does not:

```
h2 = rcosdesign(rf,span,sps,'sqrt');  
fvtool(h2,'impulse')
```

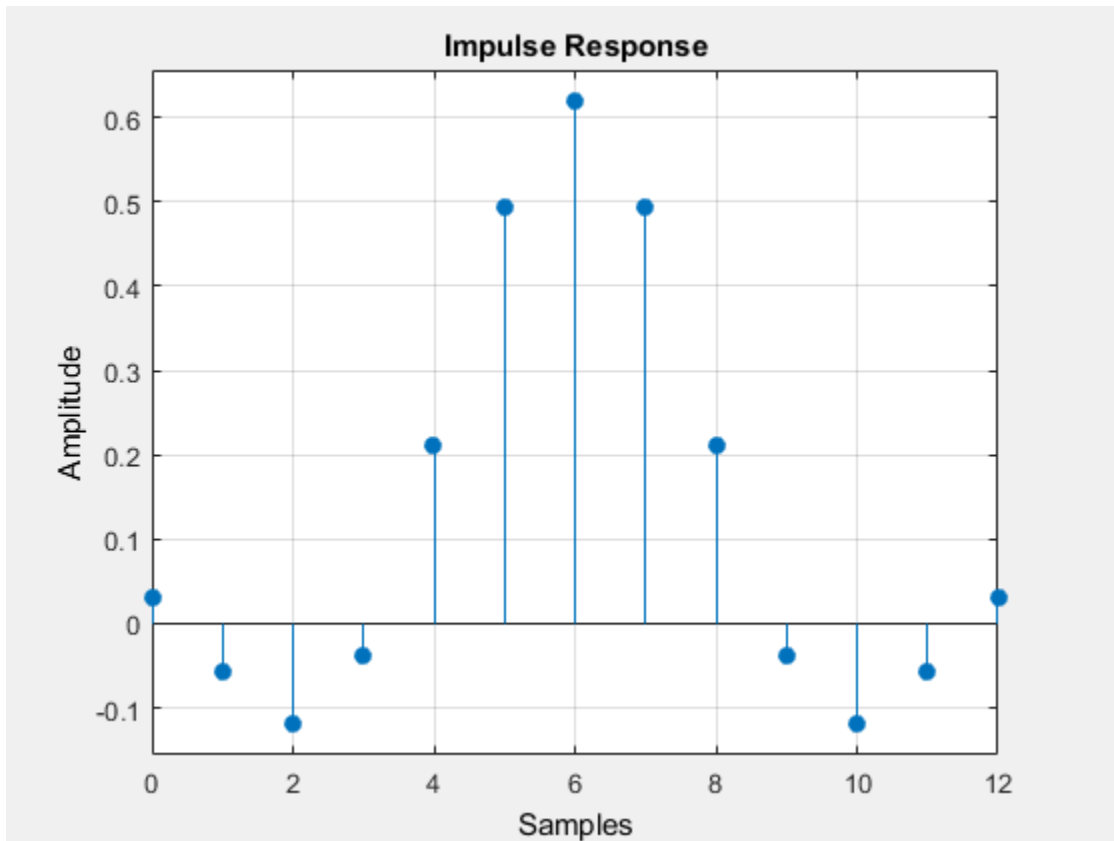

Convolve the square-root filter with itself. Truncate the impulse response outward from the maximum so it has the same length as `h1`. Normalize the response using the maximum. Then, compare the convolved square-root filter to the normal filter.

```
h3 = conv(h2,h2);
p2 = ceil(length(h3)/2);
m2 = ceil(p2-length(h1)/2);
M2 = floor(p2+length(h1)/2);
ct = h3(m2:M2);

stem([h1/max(abs(h1));ct/max(abs(ct))],'filled')
xlabel('Samples')
ylabel('Normalized amplitude')
legend('h1','h2 * h2')
```

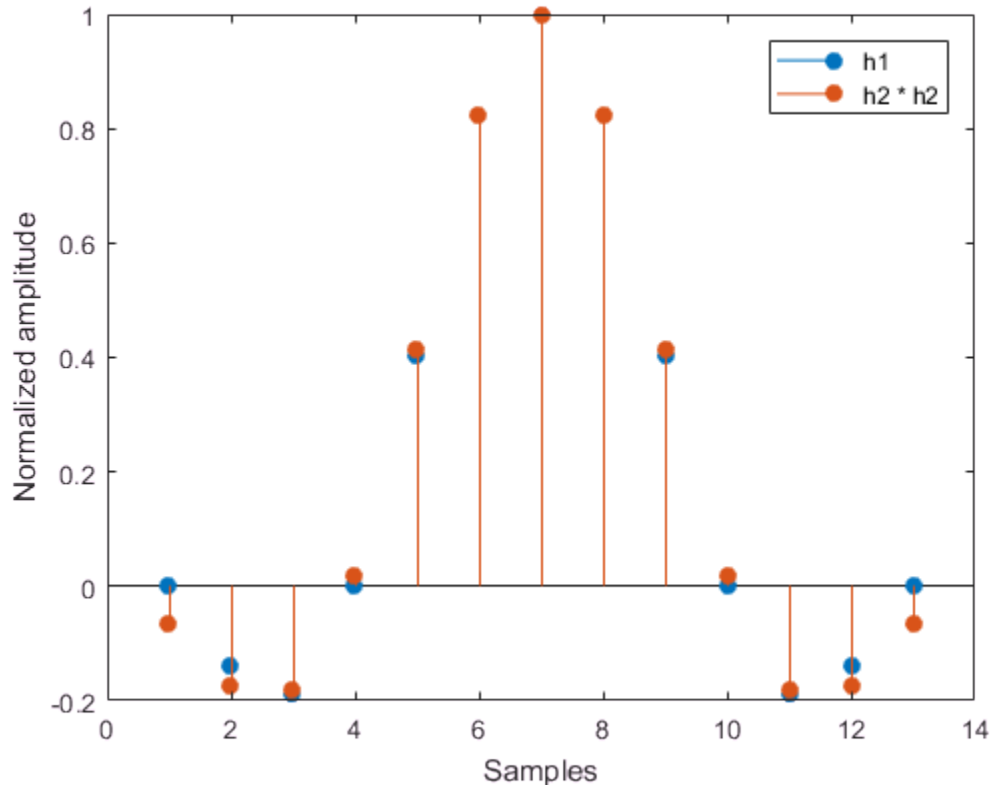

The convolved response does not coincide with the normal filter because of its finite length. Increase `span` to obtain closer agreement between the responses and better compliance with the Nyquist criterion.

Pass a Signal through a Raised Cosine Filter

This example shows how to pass a signal through a square-root, raised cosine filter.

Specify the filter parameters.

```

rolloff = 0.25;    % Rolloff factor
span = 6;         % Filter span in symbols
sps = 4;          % Samples per symbol

```

Generate the square-root, raised cosine filter coefficients.

```
b = rcosdesign(rolloff, span, sps);
```

Create a vector of bipolar data.

```
d = 2*randi([0 1], 100, 1) - 1;
```

Upsample and filter the data for pulse shaping.

```
x = upfirdn(d, b, sps);
```

Add noise.

```
r = x + randn(size(x))*0.01;
```

Filter and downsample the received signal for matched filtering.

```
y = upfirdn(r, b, 1, sps);
```

Interpolate and Decimate Using RRC Filter

This example shows how to interpolate and decimate signals using square-root, raised cosine filters designed with the `rcosdesign` function. This example requires the Communications System Toolbox software.

Define the square-root raised cosine filter parameters. Define the signal constellation parameters.

```
rolloff = 0.25; % Filter rolloff  
span = 6;      % Filter span  
sps = 4;       % Samples per symbol  
M = 4;         % Size of the signal constellation  
k = log2(M);   % Number of bits per symbol
```

Generate the coefficients of the square-root raised cosine filter using the `rcosdesign` function.

```
rrcFilter = rcosdesign(rolloff, span, sps);
```

Generate 10000 data symbols using the `randi` function.

```
data = randi([0 M-1], 10000, 1);
```

Apply PSK modulation to the data symbols. Because the constellation size is 4, the modulation type is QPSK.

```
modData = pskmod(data, M, pi/4);
```

Using the `upfirdn` function, upsample and filter the input data.

```
txSig = upfirdn(modData, rrcFilter, sps);
```

Convert the Eb/No to SNR and then pass the signal through an AWGN channel.

```
EbNo = 7;
snr = EbNo + 10*log10(k) - 10*log10(sps);
rxSig = awgn(txSig, snr, 'measured');
```

Filter and downsample the received signal. Remove a portion of the signal to account for the filter delay.

```
rxFilt = upfirdn(rxSig, rrcFilter, 1, sps);
rxFilt = rxFilt(span+1:end-span);
```

Create a scatterplot of the modulated data using the first 5000 symbols.

```
hScatter = scatterplot(sqrt(sps)* ...
    rxSig(1:sps*5000), ...
    sps,0,'g. ');
hold on
scatterplot(rxFilt(1:5000),1,0,'kx',hScatter)
title('Received Signal, Before and After Filtering')
legend('Before Filtering','After Filtering')
axis([-3 3 -3 3]) % Set axis ranges
hold off
```

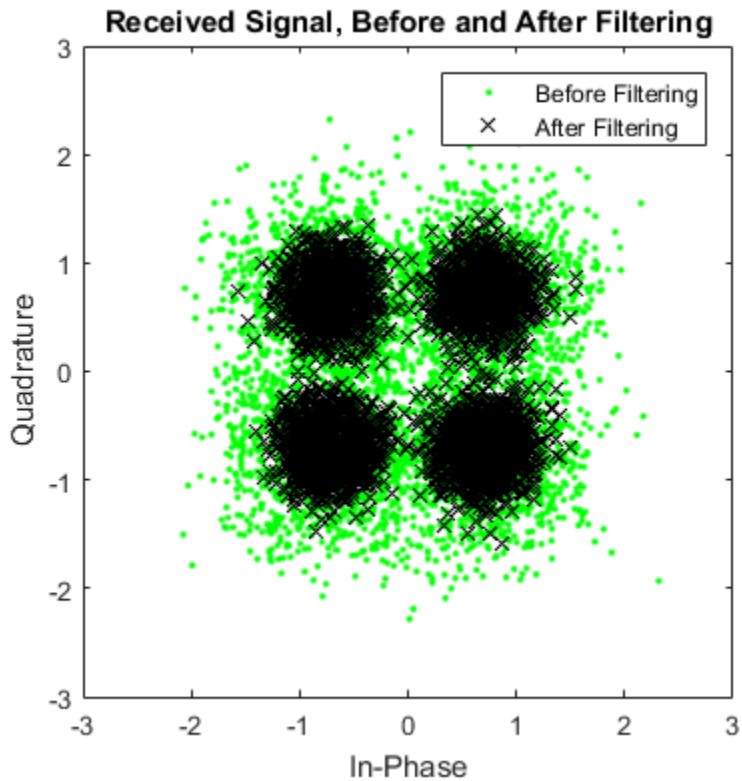

Input Arguments

beta — Rolloff factor

real nonnegative scalar

Rolloff factor, specified as a real nonnegative scalar not greater than 1. The rolloff factor determines the excess bandwidth of the filter. Zero rolloff corresponds to a brick-wall filter and unit rolloff to a pure raised cosine.

Data Types: `double` | `single`

span — Number of symbols

positive scalar

Number of symbols, specified as a positive integer scalar.

Data Types: `double` | `single`

sps — Samples per symbol

positive integer scalar

Number of samples per symbol (oversampling factor), specified as a positive integer scalar.

Data Types: `double` | `single`

shape — Shape of the raised cosine window

'sqrt' (default) | 'normal'

Shape of the raised cosine window, specified as either 'normal' or 'sqrt'.

Data Types: `char`

Output Arguments

b — FIR filter coefficients

row vector

Raised cosine filter coefficients, returned as a row vector.

Data Types: `double` | `single`

Tips

- If you have a license for Communications System Toolbox™ software, you can perform multirate raised cosine filtering with streaming behavior. To do so, use the System object filters, `comm.RaisedCosineTransmitFilter` and `comm.RaisedCosineReceiveFilter`.

References

- [1] Tranter, William H., K. Sam Shanmugan, Theodore S. Rappaport, and Kurt L. Kosbar. *Principles of Communication Systems Simulation with Wireless Applications*. Upper Saddle River, NJ: Prentice Hall, 2004.

Extended Capabilities

C/C++ Code Generation

Generate C and C++ code using MATLAB® Coder™.

Usage notes and limitations:

All inputs must be constant. Expressions or variables are allowed if their values do not change.

See Also

See Also

gaussdesign

Introduced in R2013b

rectpuls

Sampled aperiodic rectangle

Syntax

```
y = rectpuls(t)
y = rectpuls(t,w)
```

Description

`y = rectpuls(t)` returns a continuous, aperiodic, unity-height rectangular pulse at the sample times indicated in array `t`, centered about `t = 0` and with a default width of 1. Note that the interval of nonzero amplitude is defined to be open on the right, that is, `rectpuls(-0.5) = 1` while `rectpuls(0.5) = 0`.

`y = rectpuls(t,w)` generates a rectangle of width `w`.

`rectpuls` is typically used in conjunction with the pulse train generating function `pulstran`.

Examples

Generate and Displace Rectangular Pulse

Generate 200 ms of a rectangular pulse with a sample rate of 10 kHz and a width of 20 ms.

```
fs = 10e3;
t = -0.1:1/fs:0.1;
```

```
w = 20e-3;
```

```
x = rectpuls(t,w);
```

Generate two copies of the same pulse:

- One displaced 45 ms into the past.

```
tpast = -45e-3;  
xpast = rectpuls(t-tpast,w);
```

- One displaced 60 ms into the future and half as wide.

```
tfutr = 60e-3;  
xfutr = rectpuls(t-tfutr,w/2);
```

Plot the original pulse and the two copies on the same axes.

```
plot(t,x,t,xpast,t,xfutr)  
ylim([-0.2 1.2])
```

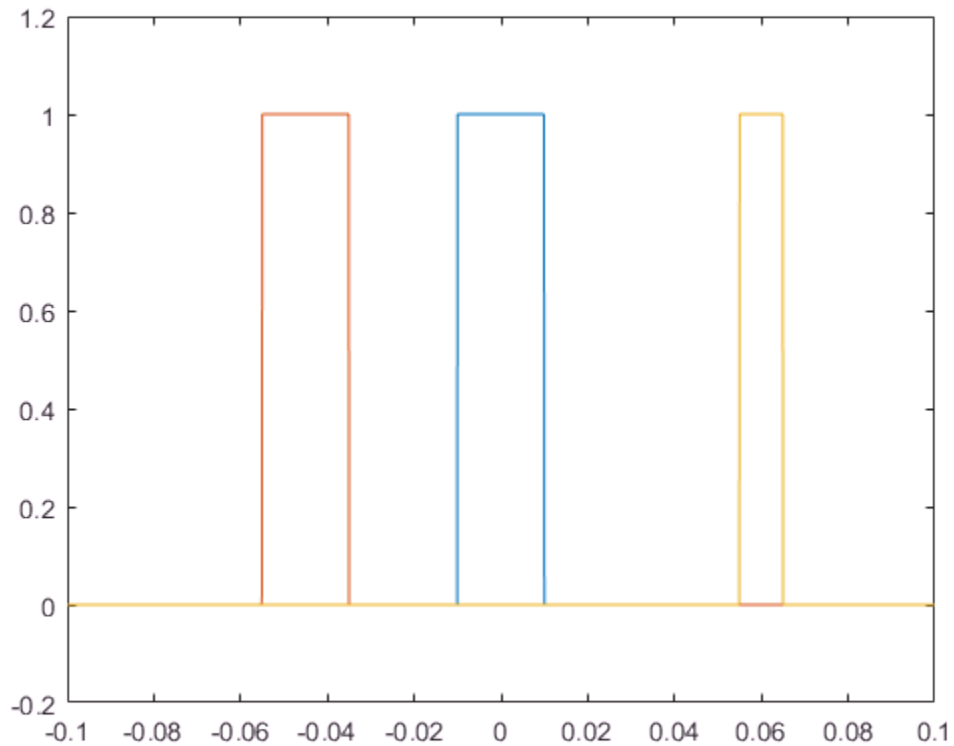

See Also

chirp | cos | diric | gauspuls | pulstran | sawtooth | sin | sinc | square |
tripuls

Introduced before R2006a

rectwin

Rectangular window

Syntax

```
w = rectwin(L)
```

Description

`w = rectwin(L)` returns a rectangular window of length `L` in the column vector `w`. This function is provided for completeness; a rectangular window is equivalent to no window at all.

Examples

Rectangular Window

Create a 64-point rectangular window. Display the result using `wvtool`.

```
L = 64;  
wvtool(rectwin(L))
```

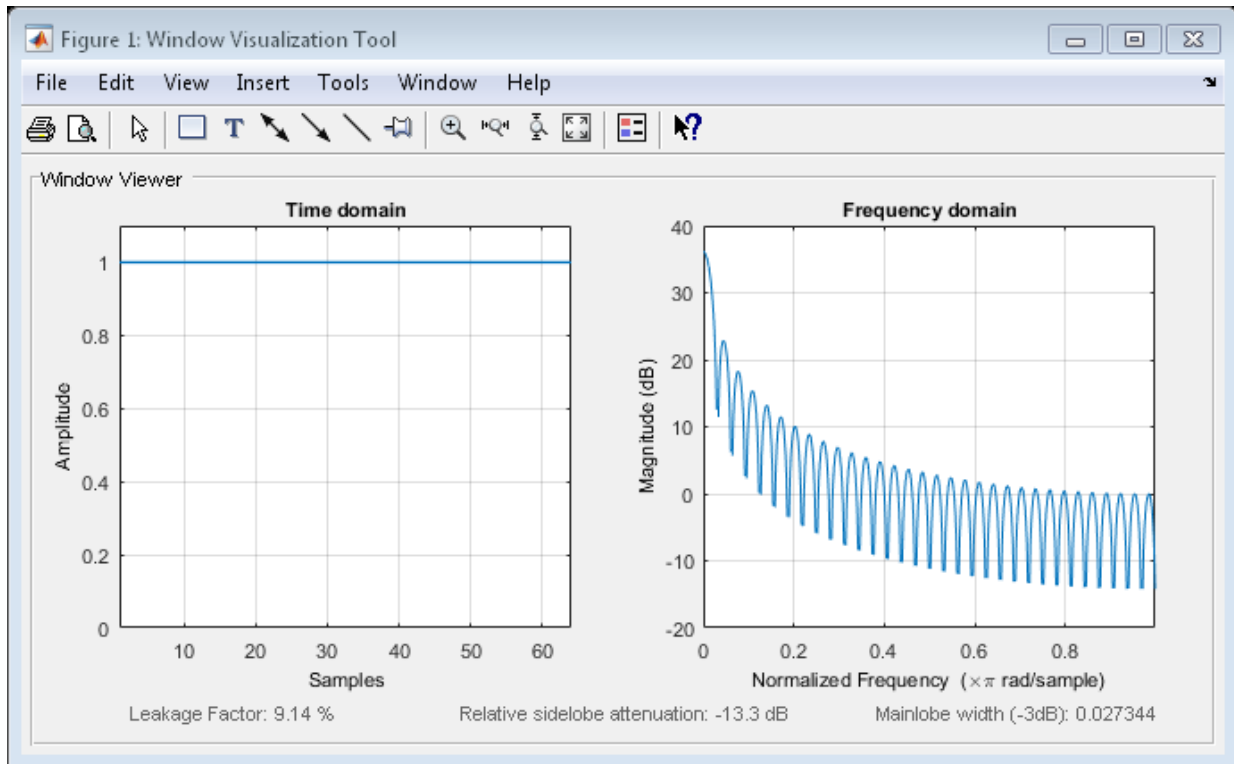

Algorithms

```
w = ones(L,1);
```

References

- [1] Oppenheim, Alan V., Ronald W. Schaffer, and John R. Buck. *Discrete-Time Signal Processing*. 2nd Ed. Upper Saddle River, NJ: Prentice Hall, 1999.

Extended Capabilities

C/C++ Code Generation

Generate C and C++ code using MATLAB® Coder™.

Usage notes and limitations:

All inputs must be constant. Expressions or variables are allowed if their values do not change.

See Also

See Also

Apps

Window Designer

Functions

barthannwin | bartlett | blackmanharris | bohmanwin | nuttallwin |
parzenwin | triang | window | wvtool

Introduced before R2006a

resample

Resample uniform or nonuniform data to new fixed rate

Syntax

```
y = resample(x,p,q)
y = resample(x,p,q,n)
y = resample(x,p,q,n,beta)
y = resample(x,p,q,b)
[y,b] = resample(x,p,q, ___ )

y = resample(x,tx)
y = resample(x,tx,fs)
y = resample(x,tx,fs,p,q)
y = resample(x,tx,___,method)
[y,ty] = resample(x,tx,___ )
[y,ty,b] = resample(x,tx,___ )
```

Description

`y = resample(x,p,q)` resamples the input sequence, `x`, at `p/q` times the original sample rate. If `x` is a matrix, then `resample` treats each column of `x` as an independent channel. `resample` applies an antialiasing FIR lowpass filter to `x` and compensates for the delay introduced by the filter.

`y = resample(x,p,q,n)` uses an antialiasing filter of order $2 \times n \times \max(p,q)$.

`y = resample(x,p,q,n,beta)` specifies the shape parameter of the Kaiser window used to design the lowpass filter.

`y = resample(x,p,q,b)` filters `x` using the filter coefficients specified in `b`.

`[y,b] = resample(x,p,q, ___)` also returns the coefficients of the filter applied to `x` during the resampling.

`y = resample(x,tx)` resamples the values, `x`, of a signal sampled at the instants specified in vector `tx`. The function interpolates `x` linearly onto a vector of uniformly

spaced instants with the same endpoints and number of samples as `tx`. NaNs are treated as missing data and are ignored.

`y = resample(x,tx,fs)` uses a polyphase antialiasing filter to resample the signal at the uniform sample rate specified in `fs`.

`y = resample(x,tx,fs,p,q)` interpolates the input signal to a uniform grid with a sample spacing of $(p/q)/fs$ and then filters the result to upsample it by `p` and downsample it by `q`. For best results, ensure that $fs \times q/p$ is at least twice as large as the highest frequency component of `x`.

`y = resample(x,tx, ___,method)` specifies the interpolation method along with any of the arguments from previous syntaxes in this group. The interpolation method can be 'linear', 'pchip', or 'spline'.

Note: If `x` is not slowly varying, consider using `interp1` with the 'pchip' interpolation method.

`[y,ty] = resample(x,tx, ___)` returns in `ty` the instants that correspond to the resampled signal.

`[y,ty,b] = resample(x,tx, ___)` returns in `b` the coefficients of the antialiasing filter.

Examples

Resample Linear Sequence

Resample a simple linear sequence at 3/2 the original rate of 10 Hz. Plot the original and resampled signals on the same figure.

```
fs = 10;
t1 = 0:1/fs:1;
x = t1;
y = resample(x,3,2);
t2 = (0:(length(y)-1))*2/(3*fs);

plot(t1,x,'*',t2,y,'o')
xlabel('Time (s)')
ylabel('Signal')
legend('Original','Resampled', ...
       'Location','NorthWest')
```

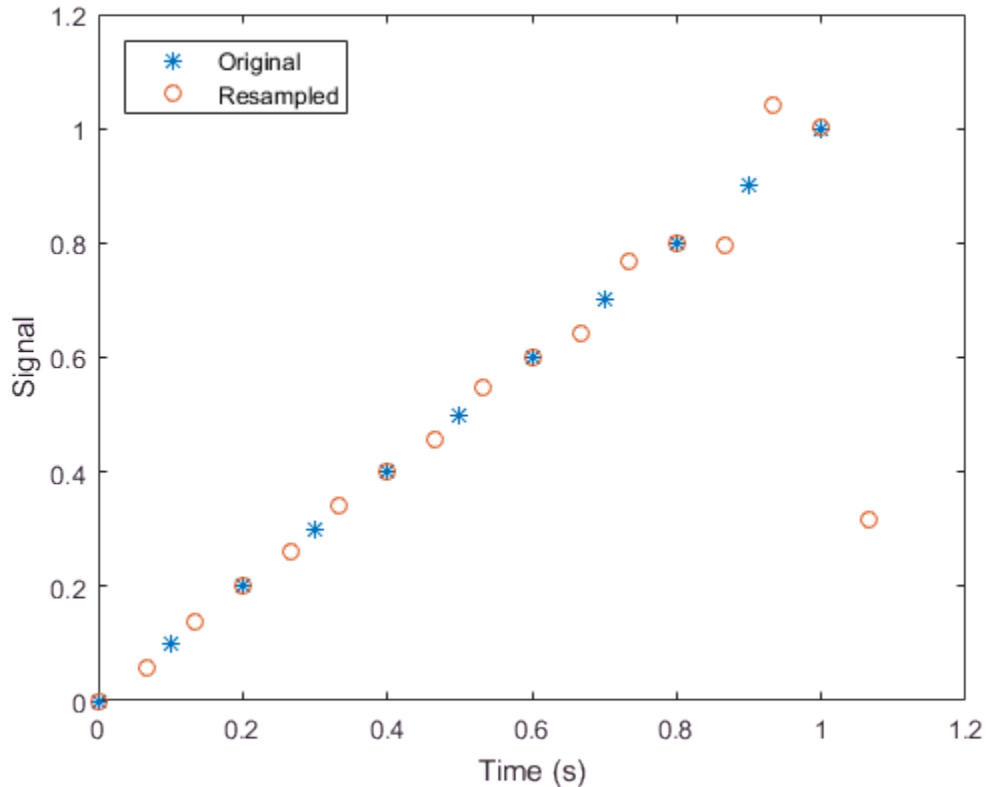

When filtering, `resample` assumes that the input sequence, `x`, is zero before and after the samples it is given. Large deviations from zero at the endpoints of `x` can result in unexpected values for `y`.

Show these deviations by resampling a triangular sequence and a vertically shifted version of the sequence with nonzero endpoints.

```
x = [1:10 9:-1:1;
     10:-1:1 2:10]';
y = resample(x,3,2);

subplot(2,1,1)
plot(1:19,x(:,1),'*', (0:28)*2/3 + 1,y(:,1),'o')
title('Edge Effects Not Noticeable')
```

```

legend('Original', 'Resampled', ...
      'Location', 'South')

subplot(2,1,2)
plot(1:19,x(:,2),'*', (0:28)*2/3 + 1,y(:,2),'o')
title('Edge Effects Noticeable')
legend('Original', 'Resampled', ...
      'Location', 'North')

```

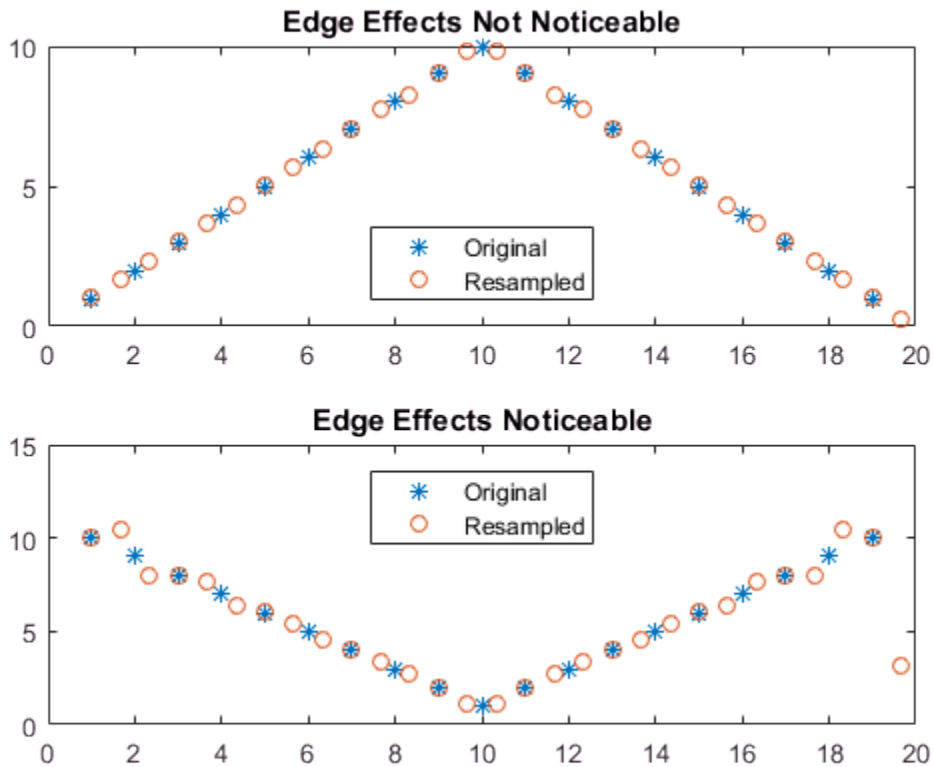

Resample Using Kaiser Window

Construct a sinusoidal signal. Specify a sample rate such that 16 samples correspond to exactly one signal period. Draw a stem plot of the signal. Overlay a stairstep graph for sample-and-hold visualization.

```
fs = 16;  
t = 0:1/fs:1-1/fs;  
  
x = 0.75*sin(2*pi*t);  
  
stem(t,x)  
hold on  
stairs(t,x)  
hold off
```

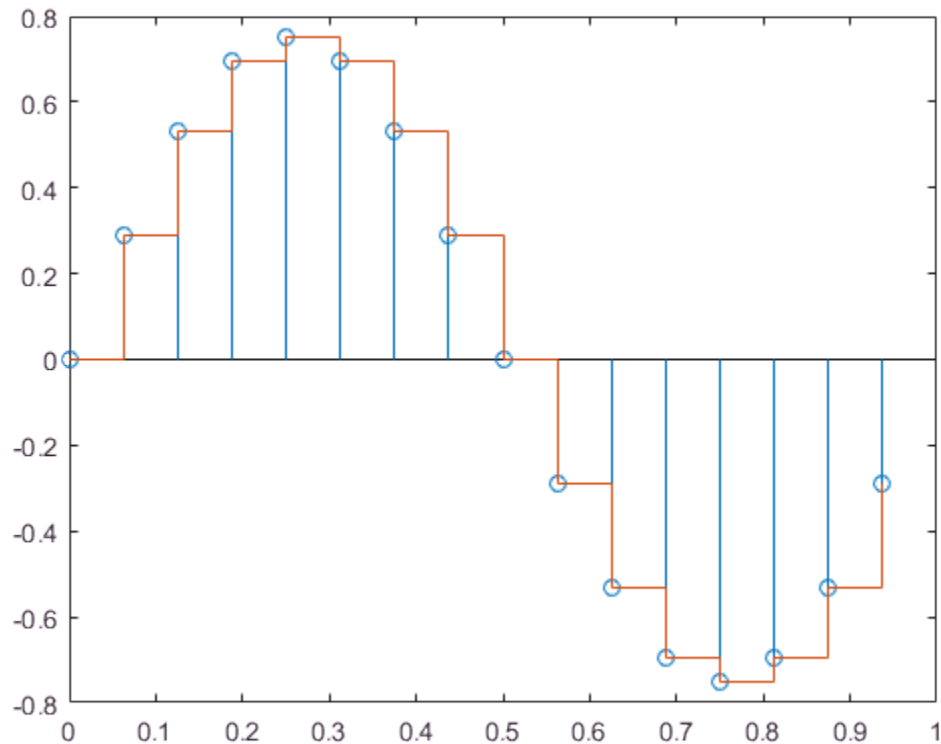

Use `resample` to upsample the signal by a factor of four. Use the default settings. Plot the result alongside the original signal.

```
ups = 4;
```

```
dns = 1;  
  
fu = fs*ups;  
tu = 0:1/fu:1-1/fu;  
  
y = resample(x,ups,dns);  
  
stem(tu,y)  
hold on  
stairs(t,x)  
hold off  
legend('Resampled','Original')
```

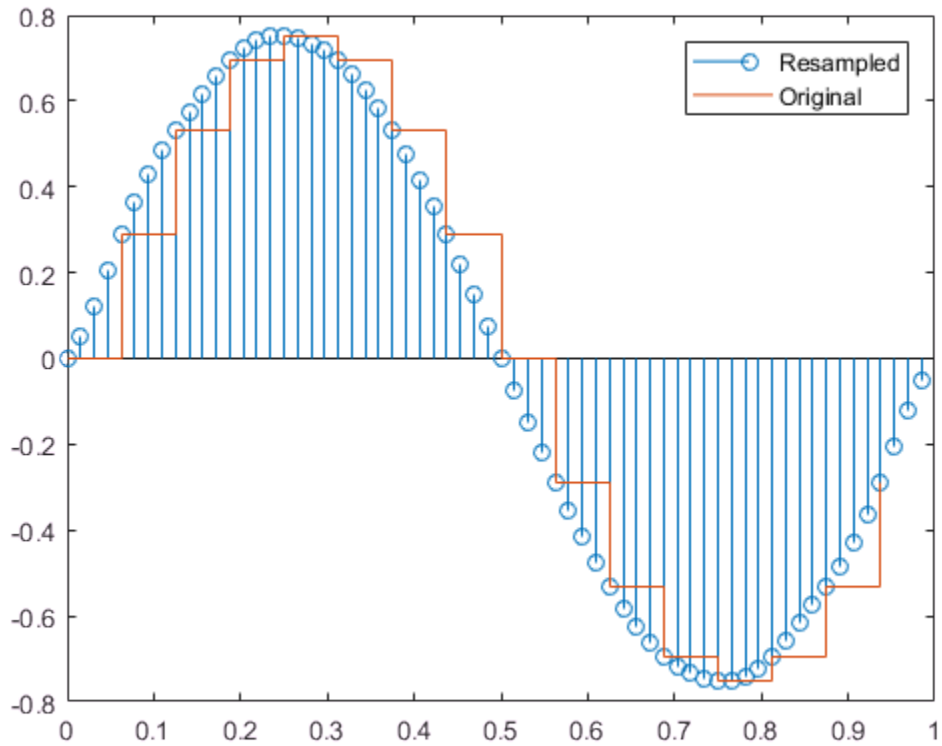

Repeat the calculation. Specify $n = 1$ so that the antialiasing filter is of order $2 \times 1 \times 4 = 8$. Specify a shape parameter $\beta = 0$ for the Kaiser window. Output the filter as well as the resampled signal.

```
n = 1;
beta = 0;

[y,b] = resample(x,ups,dns,n,beta);

fo = filtord(b)

fo = 8

stem(tu,y)
hold on
stairs(t,x,'--')
hold off
legend('n = 1, \beta = 0')
```

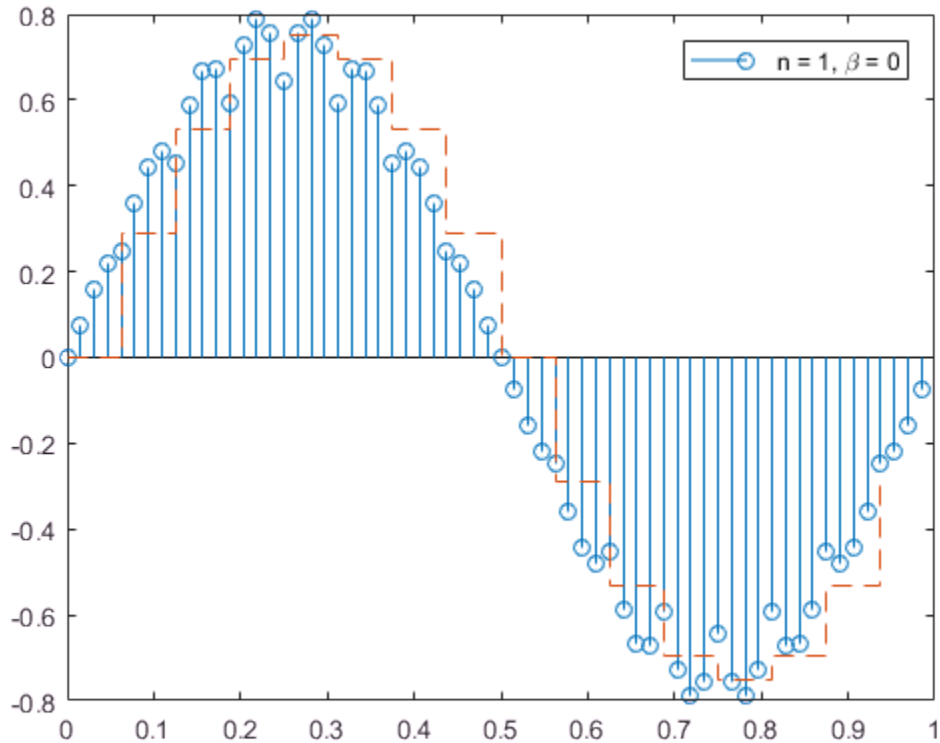

The resampled signal shows aliasing effects that result from the relatively wide mainlobe and low sidelobe attenuation of the window.

Increase n to 5 and leave $\beta = 0$. Verify that the filter is of order 40. Plot the resampled signal.

```
n = 5;
```

```
[y,b] = resample(x,ups,dns,n,beta);
```

```
fo = filtord(b)
```

```
fo = 40
```



```

stem(tu,y)
hold on
stairs(t,x,'--')
hold off
legend('n = 5, \beta = 0')

```

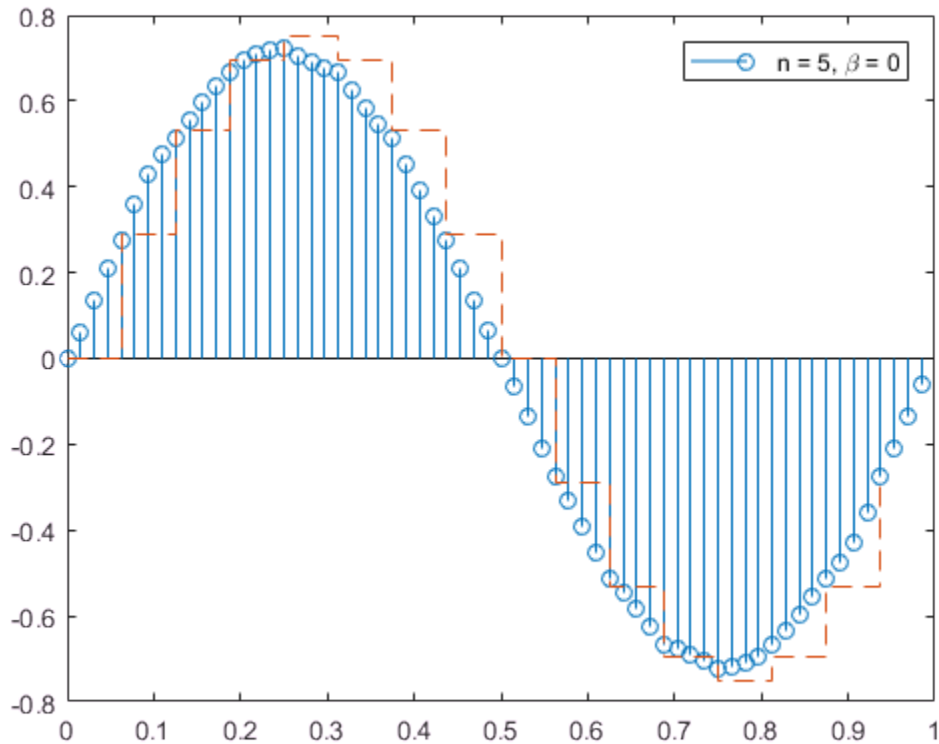

The longer window has a narrower mainlobe and attenuates aliasing effects better. It also attenuates the signal.

Leave the filter order at $2 \times 5 \times 4 = 40$ and increase the shape parameter to $\beta = 20$.

```
beta = 20;
```

```

y = resample(x,ups,dns,n,beta);

stem(tu,y)
hold on
stairs(t,x,'--')
hold off
legend('n = 5, \beta = 20')

```

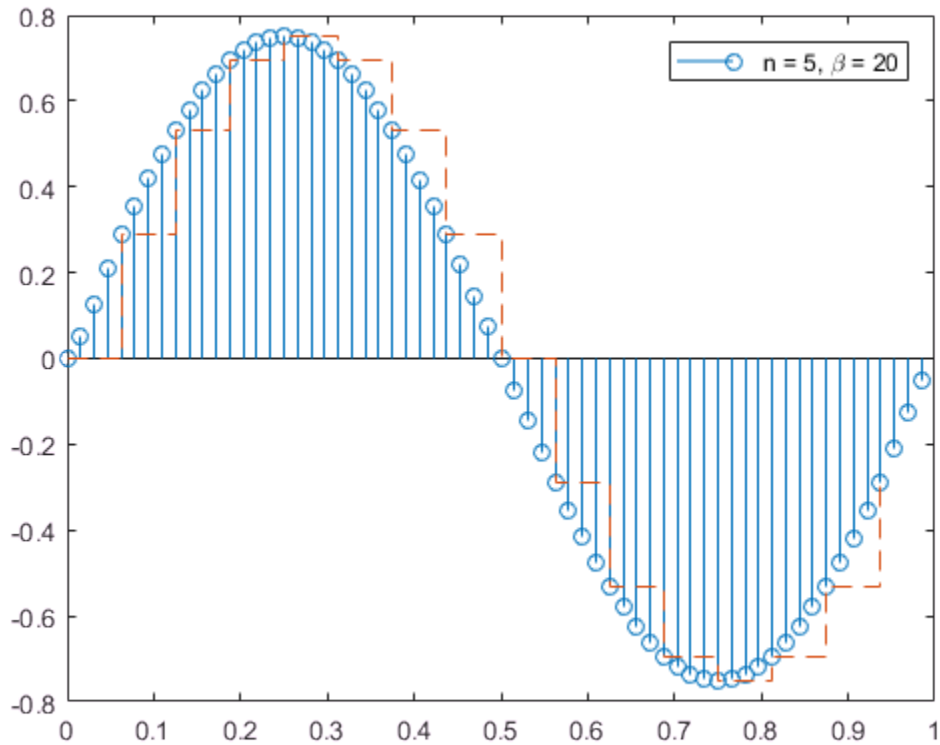

The high sidelobe attenuation results in good resampling.

Decrease the filter order back to $2 \times 1 \times 4 = 8$ and leave $\beta = 20$.

```
n = 1;
```

```
[y,b] = resample(x,ups,dns,n,beta);

stem(tu,y)
hold on
stairs(t,x,'--')
hold off
legend('n = 1, \beta = 20')
```

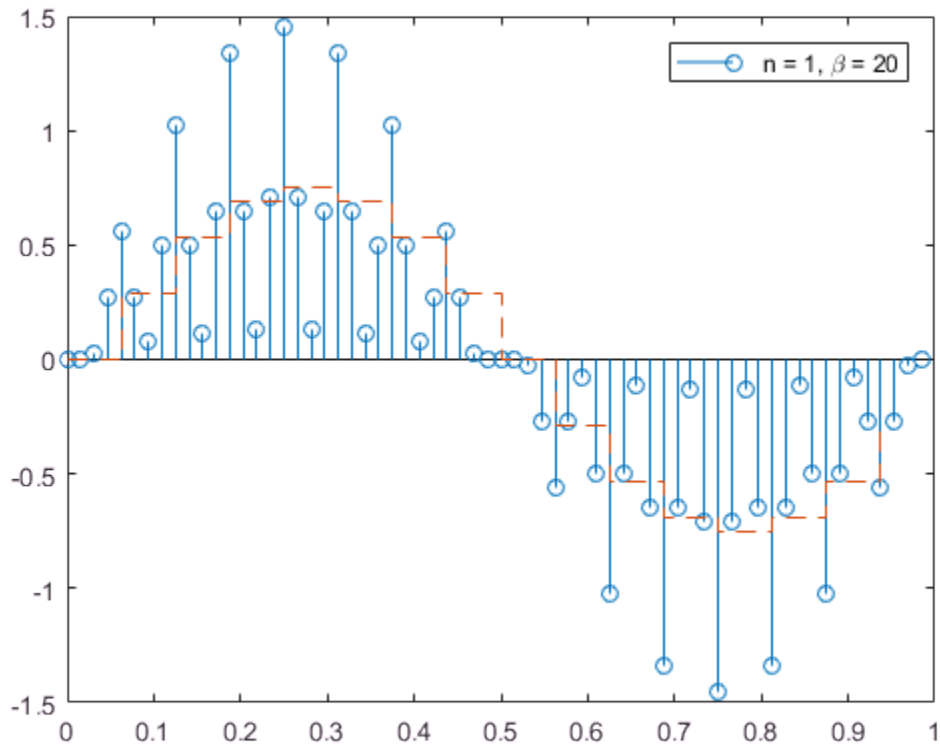

The wider mainlobe generates considerable artifacts upon resampling.

Resample a Sinusoid

Generate 60 samples of a sinusoid and resample it at $3/2$ the original rate. Display the original and resampled signals.

```

tx = 0:6:360-3;
x = sin(2*pi*tx/120);

ty = 0:4:360-2;
[y,by] = resample(x,3,2);

plot(tx,x,'+-',ty,y,'o:')
legend('original','resampled')

```

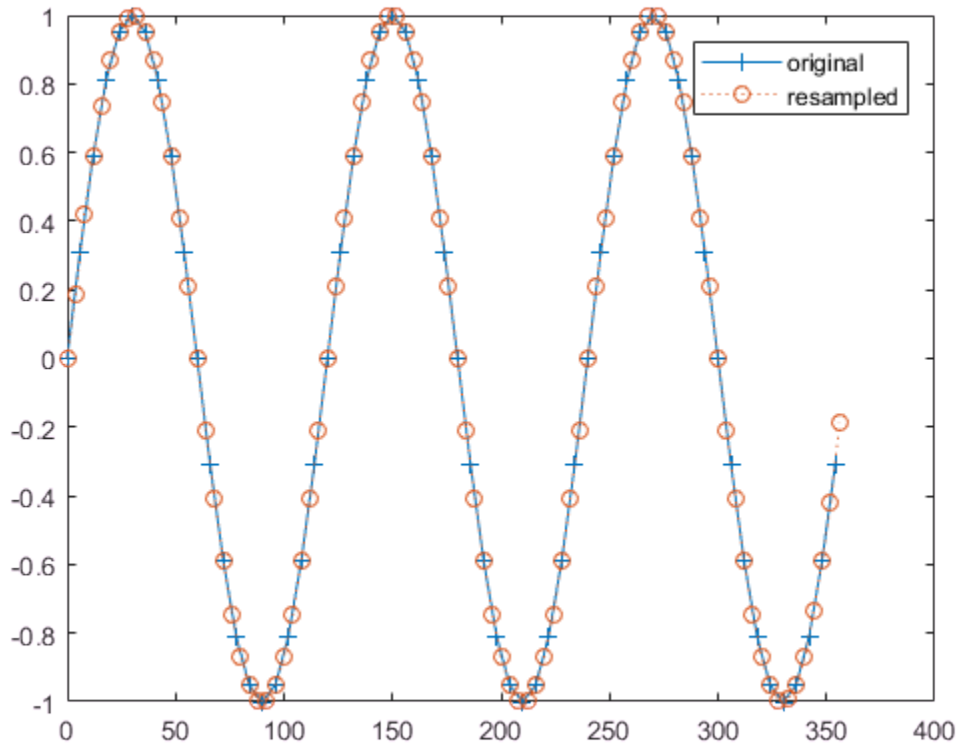

Plot the frequency response of the anti-aliasing filter.

```
freqz(by)
```

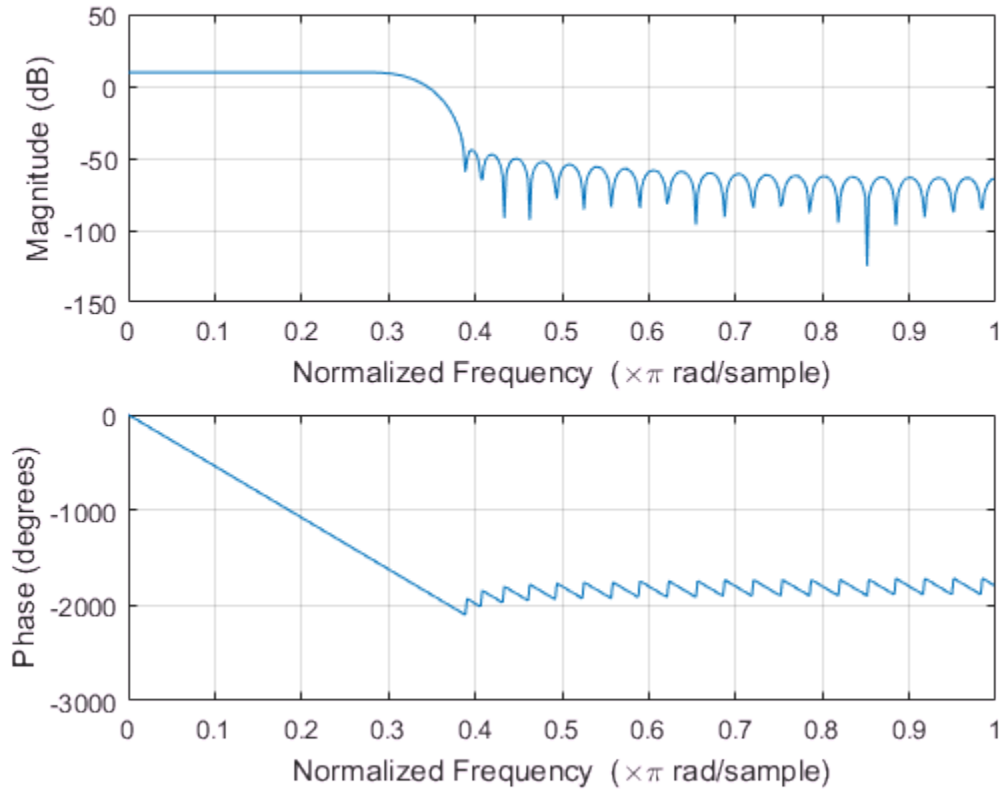

Resample the signal at $2/3$ the original rate. Display the original signal and its resampling.

```
tz = 0:9:360-9;  
[z,bz] = resample(x,2,3);  
  
plot(tx,x,'+-',tz,z,'o:')  
legend('original','resampled')
```

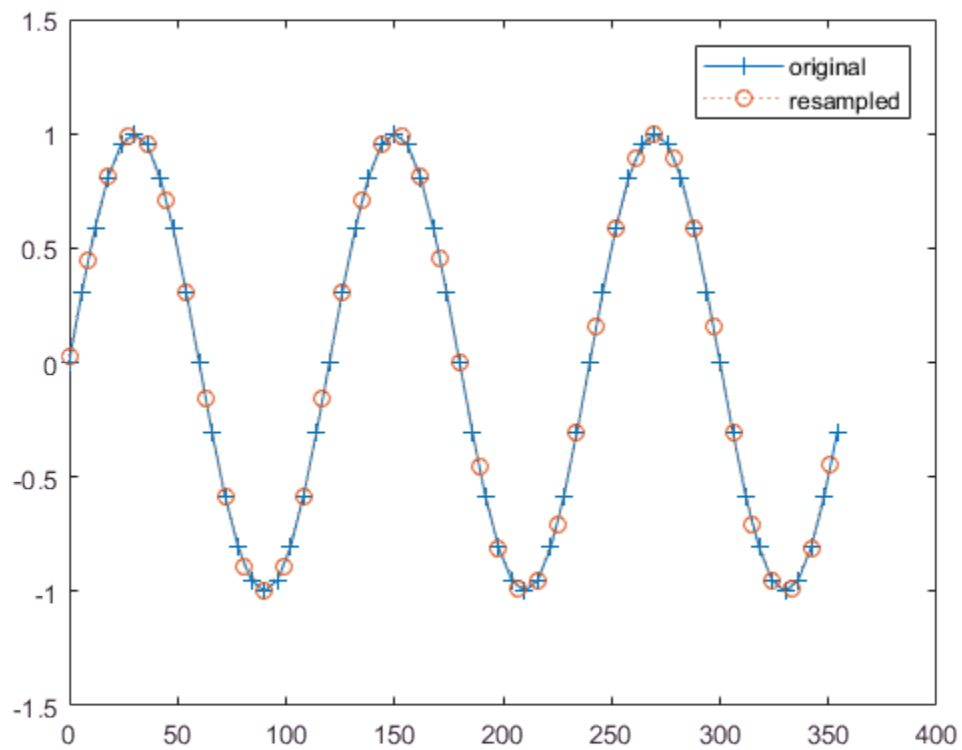

Plot the impulse response of the new lowpass filter.

```
impz(bz)
```

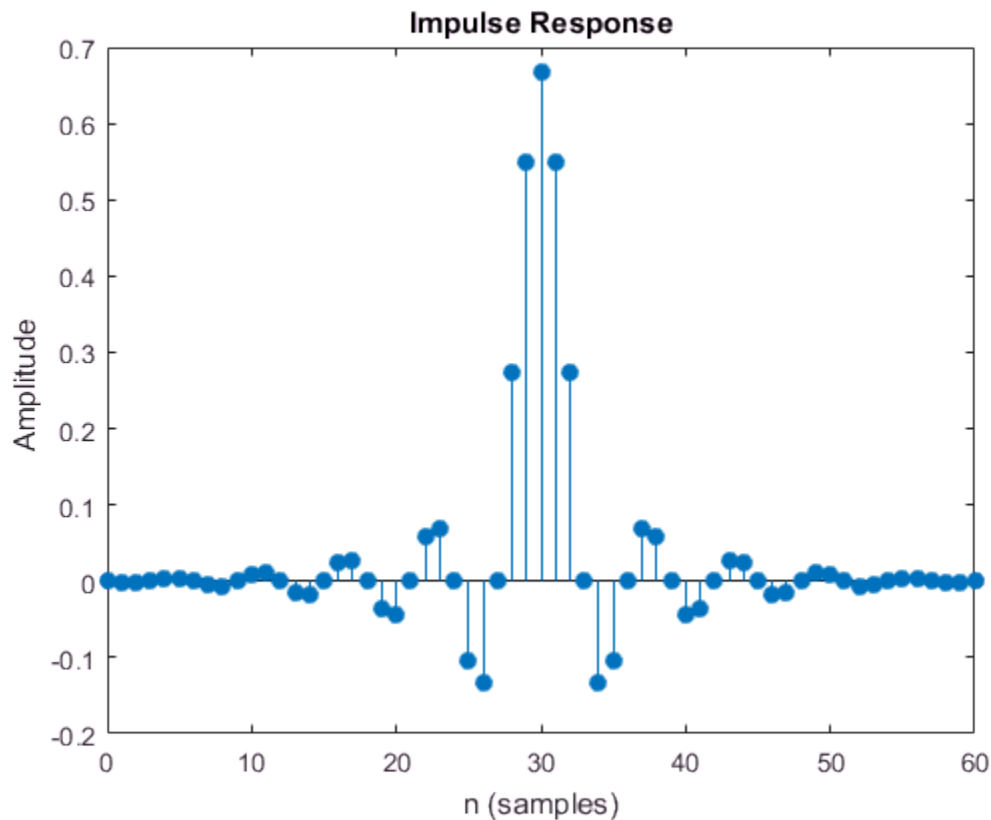

Resample a Nonuniformly Sampled Data Set

Use the data recorded by Galileo Galilei in 1610 to determine the orbital period of Callisto, the outermost of Jupiter's four largest satellites.

Galileo observed the satellites' motion for six weeks, starting on 15 January. The observations have several gaps because Jupiter was not visible on cloudy nights. Generate a `datetime` array of observation times.

```
t = [0 2 3 7 8 9 10 11 12 17 18 19 20 24 25 26 27 28 29 31 32 33 35 37 ...
     41 42 43 44 45]'+1;
```

```
yg = [10.5 11.5 10.5 -5.5 -10.0 -12.0 -11.5 -12.0 -7.5 8.5 12.5 12.5 ...
     10.5 -6.0 -11.5 -12.5 -12.5 -10.5 -6.5 2.0 8.5 10.5 13.5 10.5 -8.5 ...
```

```
-10.5 -10.5 -10.0 -8.0]';
```

```
obsv = datetime(1610,1,15+t);
```

Resample the data onto a regular grid using a sample rate of one observation per day. Use a moderate upsampling factor of 3 to avoid overfitting.

```
fs = 1;
```

```
[y,ty] = resample(yg,t,fs,3,1);
```

Plot the data and the resampled signal.

```
plot(t,yg,'o',ty,y,'.-')
xlabel('Day')
```

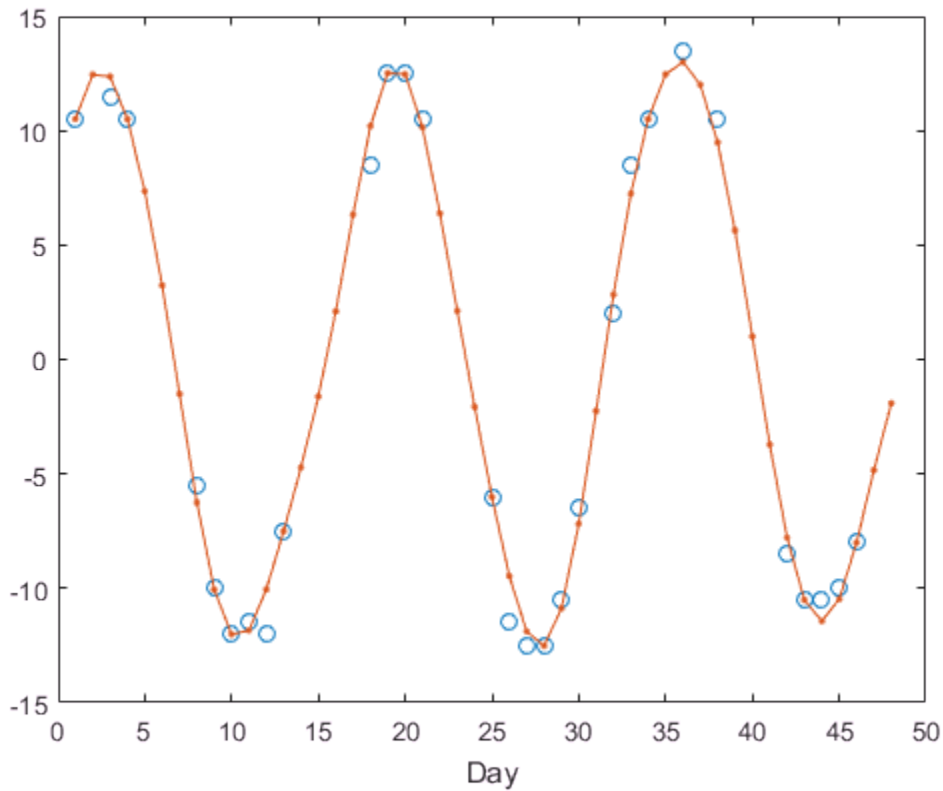

Repeat the procedure using spline interpolation and displaying the observation dates.
Express the sample rate in inverse days.

```
fs = 1/86400;

[ys,tys] = resample(yg,obsv,fs,3,1,'spline');

plot(t,yg,'o')
hold on
plot(ys,'.-')
hold off

ax = gca;
ax.XTick = t(1:9:end);
ax.XTickLabel = char(obsv(1:9:end));
```

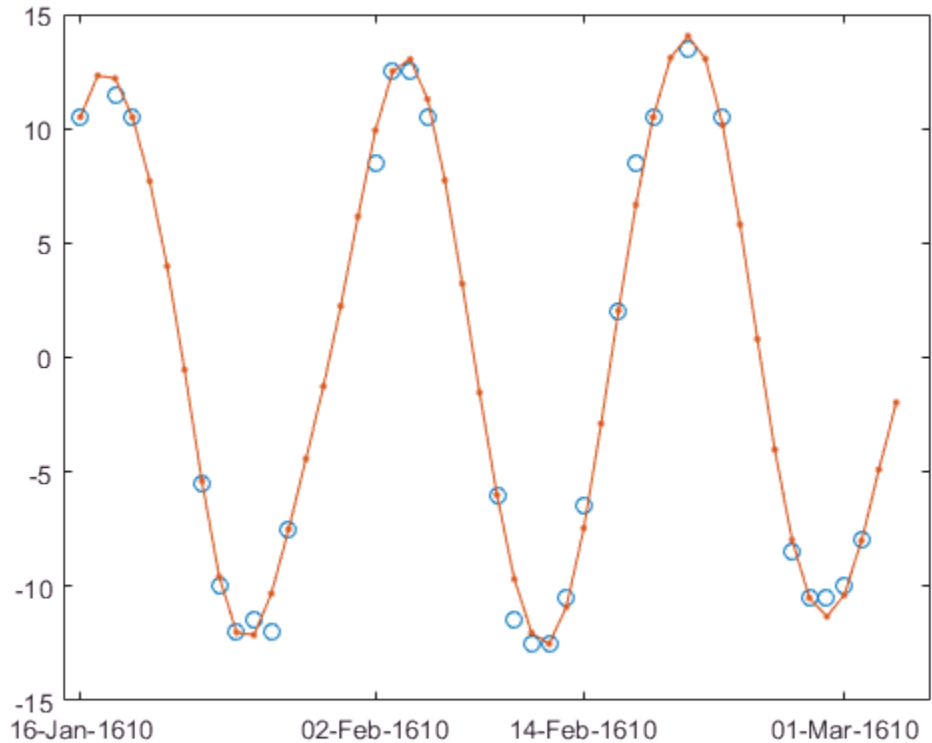

Compute the periodogram power spectrum estimate of the uniformly spaced, linearly interpolated data. Choose a DFT length of 1024. The signal peaks at the inverse of the orbital period.

```
[pxx,f] = periodogram(ys,[],1024,1,'power');  
[pk,i0] = max(pxx);
```

```
f0 = f(i0);  
T0 = 1/f0
```

```
T0 = 16.7869
```

```
plot(f,pxx,f0,pk,'o')
```

```
xlabel('Frequency (day-1)')
```

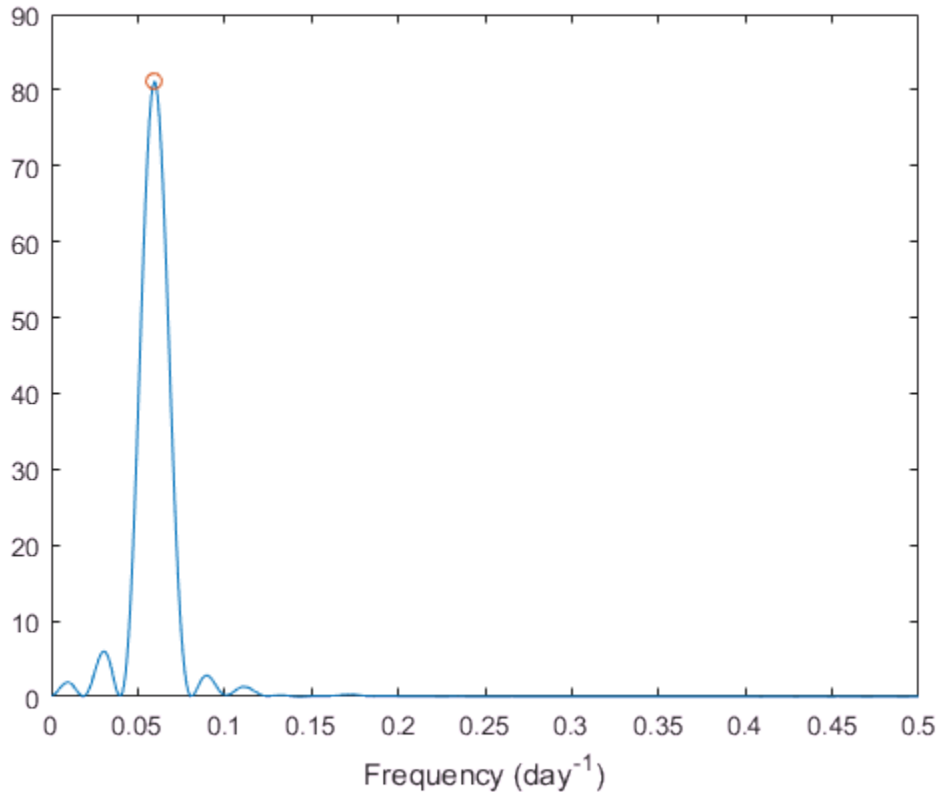

- “Reconstruct a Signal from Irregularly Sampled Data”

Input Arguments

x — Input signal

vector | matrix

Input signal, specified as a vector or matrix. If **x** is a matrix, then its columns are treated as independent channels. **x** can contain NaNs. NaNs are treated as missing data and are excluded from the resampling.

Example: `cos(pi/4*(0:159))+randn(1,160)` is a single-channel row-vector signal.

Example: `cos(pi./[4;2]*(0:159))'+randn(160,2)` is a two-channel signal.

Data Types: `single` | `double`

p, q — Resampling factors

positive integers

Resampling factors, specified as positive integers.

Data Types: `single` | `double`

n — Neighbor term number

10 (default) | positive integer

Neighbor term number, specified as a positive integer. If `n = 0`, `resample` performs nearest-neighbor interpolation. The length of the antialiasing FIR filter is proportional to `n`. Larger values of `n` provide better accuracy at the expense of more computation time.

Data Types: `single` | `double`

beta — Shape parameter of Kaiser window

5 (default) | positive real scalar

Shape parameter of Kaiser window, specified as a positive real scalar. Increasing `beta` widens the mainlobe of the window used to design the antialiasing filter and decreases the amplitude of the window's sidelobes.

Data Types: `single` | `double`

b — FIR filter coefficients

vector

FIR filter coefficients, specified as a vector. By default, `resample` designs the filter using `fir1`s with a Kaiser window. When compensating for the delay, `resample` assumes `b` has odd length and linear phase.

Example: `fir1(4,0.5)` specifies a 4th-order lowpass filter with normalized cutoff frequency 0.5π rad/sample.

Data Types: `single` | `double`

tx — Time instants

nonnegative real vector | `datetime` array

Time instants, specified as a nonnegative real vector or a `datetime` array. `tx` must increase monotonically but need not be uniformly spaced. `tx` can contain NaNs or NaTs. These values are treated as missing data and excluded from the resampling.

Data Types: `single` | `double` | `datetime`

fs — Sample rate

positive scalar

Sample rate, specified as a positive scalar. The sample rate is the number of samples per unit time. If the unit of time is seconds, then the sample rate is in Hz.

Data Types: `single` | `double`

method — Interpolation method

'linear' (default) | 'pchip' | 'spline'

Interpolation method, specified as one of 'linear', 'pchip', or 'spline':

- 'linear' — Linear interpolation.
- 'pchip' — Shape-preserving piecewise cubic interpolation.
- 'spline' — Spline interpolation using not-a-knot end conditions.

See the `interp1` reference page for more information.

Data Types: `char`

Output Arguments

y — Resampled signal

vector | matrix

Resampled signal, returned as a vector or matrix. If `x` is a signal of length N and you specify `p`, `q`, then `y` is of length $[N \times p/q]$.

b — FIR filter coefficients

vector

FIR filter coefficients, returned as a vector.

Data Types: `single` | `double`

ty — Output instants

nonnegative real vector

Output instants, returned as a nonnegative real vector.

Data Types: `single` | `double`

Algorithms

`resample` performs an FIR design using `firls`, normalizes the result to account for the processing gain of the window, and then implements a rate change using `upfirdn`.

Extended Capabilities

C/C++ Code Generation

Generate C and C++ code using MATLAB® Coder™.

Usage notes and limitations:

C and C++ code generation for `resample` requires DSP System Toolbox software.

The upsampling and downsampling factors must be specified as constants. Expressions or variables are allowed if their values do not change.

See Also

See Also

`decimate` | `downsample` | `firls` | `interp` | `interp1` | `intfilt` | `kaiser` | `spline`
| `upfirdn` | `upsample`

Topics

“Reconstruct a Signal from Irregularly Sampled Data”

Introduced before R2006a

residuez

Z-transform partial-fraction expansion

Syntax

```
[r,p,k] = residuez(b,a)
[b,a] = residuez(r,p,k)
```

Description

`residuez` converts a discrete time system, expressed as the ratio of two polynomials, to partial fraction expansion, or residue, form. It also converts the partial fraction expansion back to the original polynomial coefficients.

Note: Numerically, the partial fraction expansion of a ratio of polynomials is an ill-posed problem. If the denominator polynomial is near a polynomial with multiple roots, then small changes in the data, including round-off errors, can cause arbitrarily large changes in the resulting poles and residues. You should use state-space or pole-zero representations instead.

`[r,p,k] = residuez(b,a)` finds the residues, poles, and direct terms of a partial fraction expansion of the ratio of two polynomials, $b(z)$ and $a(z)$. Vectors `b` and `a` specify the coefficients of the polynomials of the discrete-time system $b(z)/a(z)$ in descending powers of z .

$$B(z) = b_0 + b_1 z^{-1} + b_2 z^{-2} + \dots + b_m z^{-m}$$

$$A(z) = a_0 + a_1 z^{-1} + a_2 z^{-2} + \dots + a_n z^{-n}$$

If there are no multiple roots and $a > n - 1$,

$$\frac{B(z)}{A(z)} = \frac{r(1)}{1 - p(1)z^{-1}} + \dots + \frac{r(n)}{1 - p(n)z^{-1}} + k(1) + k(2)z^{-1} + \dots + k(m - n + 1)z^{-(m-n)}$$

The returned column vector **r** contains the residues, column vector **p** contains the pole locations, and row vector **k** contains the direct terms. The number of poles is

$$n = \text{length}(a) - 1 = \text{length}(r) = \text{length}(p)$$

The direct term coefficient vector **k** is empty if $\text{length}(b)$ is less than $\text{length}(a)$; otherwise:

$$\text{length}(k) = \text{length}(b) - \text{length}(a) + 1$$

If $p(j) = \dots = p(j+s-1)$ is a pole of multiplicity **s**, then the expansion includes terms of the form

$$\frac{r(j)}{1 - p(j)z^{-1}} + \frac{r(j+1)}{(1 - p(j)z^{-1})^2} + \dots + \frac{r(j+s-1)}{(1 - p(j)z^{-1})^s}$$

`[b,a] = residuez(r,p,k)` with three input arguments and two output arguments, converts the partial fraction expansion back to polynomials with coefficients in row vectors **b** and **a**.

The `residue` function in the standard MATLAB language is very similar to `residuez`. It computes the partial fraction expansion of continuous-time systems in the Laplace domain (see reference [1]), rather than discrete-time systems in the *z*-domain as does `residuez`.

Examples

Partial-Fraction Expansion of IIR Lowpass Filter

Compute the partial-fraction expansion corresponding to the third-order IIR lowpass filter described by the transfer function

$$H(z) = \frac{0.05634(1 + z^{-1})(1 - 1.0166z^{-1} + z^{-2})}{(1 - 0.683z^{-1})(1 - 1.4461z^{-1} + 0.7957z^{-2})}$$

Express the numerator and denominator as polynomial convolutions.

```
b0 = 0.05634;  
b1 = [1 1];  
b2 = [1 -1.0166 1];  
a1 = [1 -0.683];  
a2 = [1 -1.4461 0.7957];
```

```
b = b0*conv(b1,b2);  
a = conv(a1,a2);
```

Compute the residues, poles, and direct terms of the partial-fraction expansion.

```
[r,p,k] = residuez(b,a)
```

```
r =  
-0.1153 - 0.0182i  
-0.1153 + 0.0182i  
0.3905 + 0.0000i
```

```
p =  
0.7230 + 0.5224i  
0.7230 - 0.5224i  
0.6830 + 0.0000i
```

```
k = -0.1037
```

Plot the poles and zeros of the transfer function and overlay the poles you just found.

```
zplane(b,a)  
hold on  
plot(p,'^r')  
hold off
```

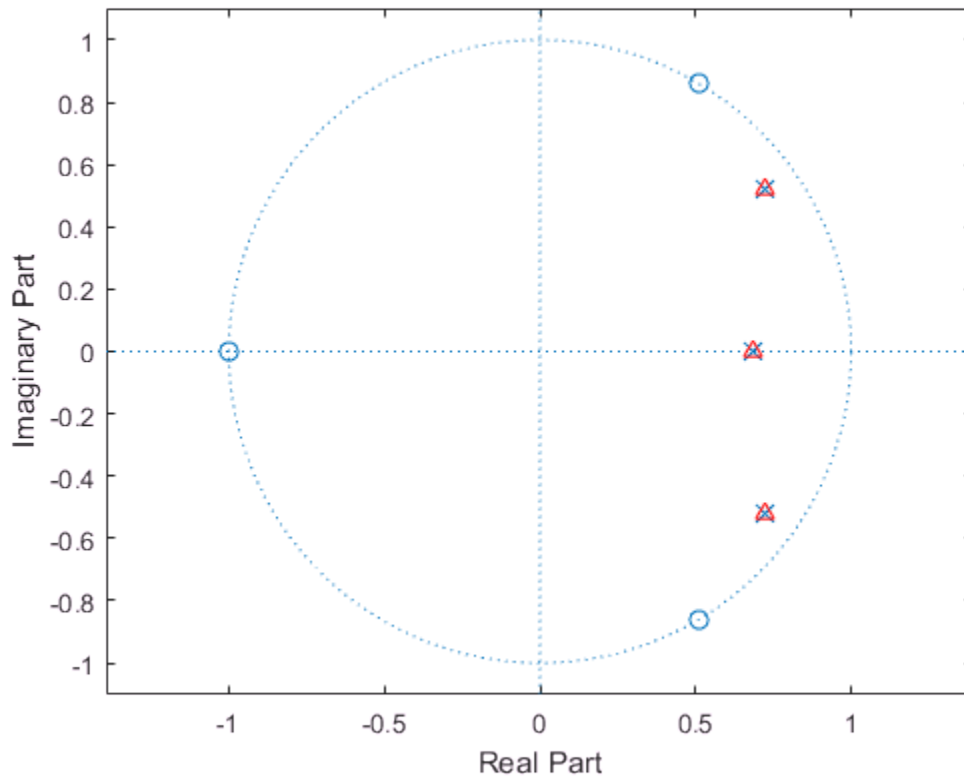

Use `residuez` again to reconstruct the transfer function.

```
[bn,an] = residuez(r,p,k)
```

bn =

```
0.0563 -0.0009 -0.0009 0.0563
```

an =

```
1.0000 -2.1291 1.7834 -0.5435
```

Algorithms

`residuez` applies standard MATLAB functions and partial fraction techniques to find r , p , and k from b and a . It finds

- The direct terms a using `deconv` (polynomial long division) when $\text{length}(b) > \text{length}(a) - 1$.
- The poles using $p = \text{roots}(a)$.
- Any repeated poles, reordering the poles according to their multiplicities.
- The residue for each nonrepeating pole p_j by multiplying $b(z)/a(z)$ by $1/(1 - p_j z^{-1})$ and evaluating the resulting rational function at $z = p_j$.
- The residues for the repeated poles by solving

$$S2*r2 = h - S1*r1$$

for $r2$ using `\`. h is the impulse response of the reduced $b(z)/a(z)$, $S1$ is a matrix whose columns are impulse responses of the first-order systems made up of the nonrepeating roots, and $r1$ is a column containing the residues for the nonrepeating roots. Each column of matrix $S2$ is an impulse response. For each root p_j of multiplicity s_j , $S2$ contains s_j columns representing the impulse responses of each of the following systems.

$$\frac{1}{1 - p_j z^{-1}}, \frac{1}{(1 - p_j z^{-1})^2}, \dots, \frac{1}{(1 - p_j z^{-1})^{s_j}}$$

The vector h and matrices $S1$ and $S2$ have $n + \text{xtra}$ rows, where n is the total number of roots and the internal parameter `xtra`, set to 1 by default, determines the degree of over-determination of the system of equations.

References

- [1] Oppenheim, Alan V., Ronald W. Schaffer, and John R. Buck. *Discrete-Time Signal Processing*. 2nd Ed. Upper Saddle River, NJ: Prentice Hall, 1999.

See Also

convmtx | roots | ss2tf | tf2ss | tf2zp | tf2zpk | zp2ss | deconv | poly |
prony | residue

Introduced before R2006a

risetime

Rise time of positive-going bilevel waveform transitions

Syntax

```
R = risetime(X)
R = risetime(X,FS)
R = risetime(X,T)
[R,LT,UT] = risetime(...)
[R,LT,UT,LL,UL] = risetime(...)
[...] = risetime(...,Name,Value)
risetime(...)
```

Description

`R = risetime(X)` returns a vector, `R`, containing the time each transition of the input bilevel waveform, `X`, takes to cross from the 10% to 90% reference levels. To determine the transitions, `risetime` estimates the state levels of the input waveform by a histogram method. `risetime` identifies all regions that cross the upper-state boundary of the low state and the lower-state boundary of the high state. The low-state and high-state boundaries are expressed as the state level plus or minus a multiple of the difference between the state levels. See “State-Level Tolerances” on page 1-1743. Because `risetime` uses interpolation, `R` may contain values that do not correspond to sampling instants of the bilevel waveform, `X`.

`R = risetime(X,FS)` specifies the sampling frequency in hertz. The sampling frequency determines the sample instants corresponding to the elements in `X`. The first sample instant in `X` corresponds to `t=0`. Because `risetime` uses interpolation, `R` may contain values that do not correspond to sampling instants of the bilevel waveform, `X`.

`R = risetime(X,T)` specifies the sample instants, `T`, as a vector with the same number of elements as `X`.

`[R,LT,UT] = risetime(...)` returns vectors, `LT` and `UT`, whose elements correspond to the time instants where `X` crosses the lower- and upper-percent reference levels.

`[R,LT,UT,LL,UL] = risetime(...)` returns the levels, LL and UL, that correspond to the lower- and upper-percent reference levels.

`[...] = risetime(...,Name,Value)` returns the rise times with additional options specified by one or more Name,Value pair arguments.

`risetime(...)` plots the signal and darkens the regions of each transition where rise time is computed. The plot marks the lower and upper crossings and the associated reference levels. The state levels and the corresponding associated lower- and upper-state boundaries are also plotted.

Input Arguments

X

Bilevel waveform. X is a real-valued row or column vector.

FS

Sample rate in hertz.

T

Vector of sample instants. The length of T must equal the length of the bilevel waveform, X.

Name-Value Pair Arguments

'PercentReferenceLevels'

Reference levels as a percentage of the waveform amplitude. The low-state level is defined to be 0 percent. The high-state level is defined to be 100 percent. The value of 'PercentReferenceLevels' is a two-element real row vector whose elements correspond to the lower and upper percent reference levels.

Default: [10 90]

'StateLevels'

Low- and high-state levels. Specifies the levels to use for the low- and high-state levels as a 2-element real row vector. The first element is the low-state level. The second element is the high-state level.

'Tolerance'

Tolerance levels (lower- and upper-state boundaries) expressed as a percentage. See “State-Level Tolerances” on page 1-1743.

Default: 2

Output Arguments

R

Rise times. **R** is a vector containing the duration of each positive-going transition. If you specify the sampling rate, **FS**, or the sampling instants, **T**, rise times are in seconds. If you do not specify a sampling rate, or sampling instants, rise times are in samples.

LT

Instants when positive-going transition crosses the lower-reference level. By default, the lower reference level is the 10% reference level. The upper reference level is the 90% reference level. You can change the default reference levels by specifying the '**PercentReferenceLevels**' name-value pair.

UT

Instants when positive-going transition crosses the upper-reference level. By default, the lower reference level is the 10% reference level. The upper reference level is the 90% reference level. You can change the default reference levels by specifying the '**PercentReferenceLevels**' name-value pair.

LL

Lower reference level in waveform amplitude units. **LL** is a vector containing the waveform value corresponding to the lower reference level in each positive-going transition. By default, the lower reference level is the 10% reference level. You can change the default reference levels by specifying the '**PercentReferenceLevels**' name-value pair.

UL

Upper reference level in waveform amplitude units. **LL** is a vector containing the waveform value corresponding to the upper reference level in each positive-going

transition. By default, the upper reference level is the 90% reference level. You can change the default reference levels by specifying the 'PercentReferenceLevels' name-value pair.

Examples

Rise Time in Bilevel Waveform

Determine the rise time in samples for a 2.3 V clock waveform.

Load the 2.3 V clock data. Determine the rise time in samples. Use the default 10% and 90% percent reference levels.

```
load('transitionex.mat','x')  
R = risetime(x)
```

```
R = 0.7120
```

The rise time is less than 1, indicating that the transition occurred in a fraction of a sample. Plot the data and annotate the rise time.

```
risetime(x);
```

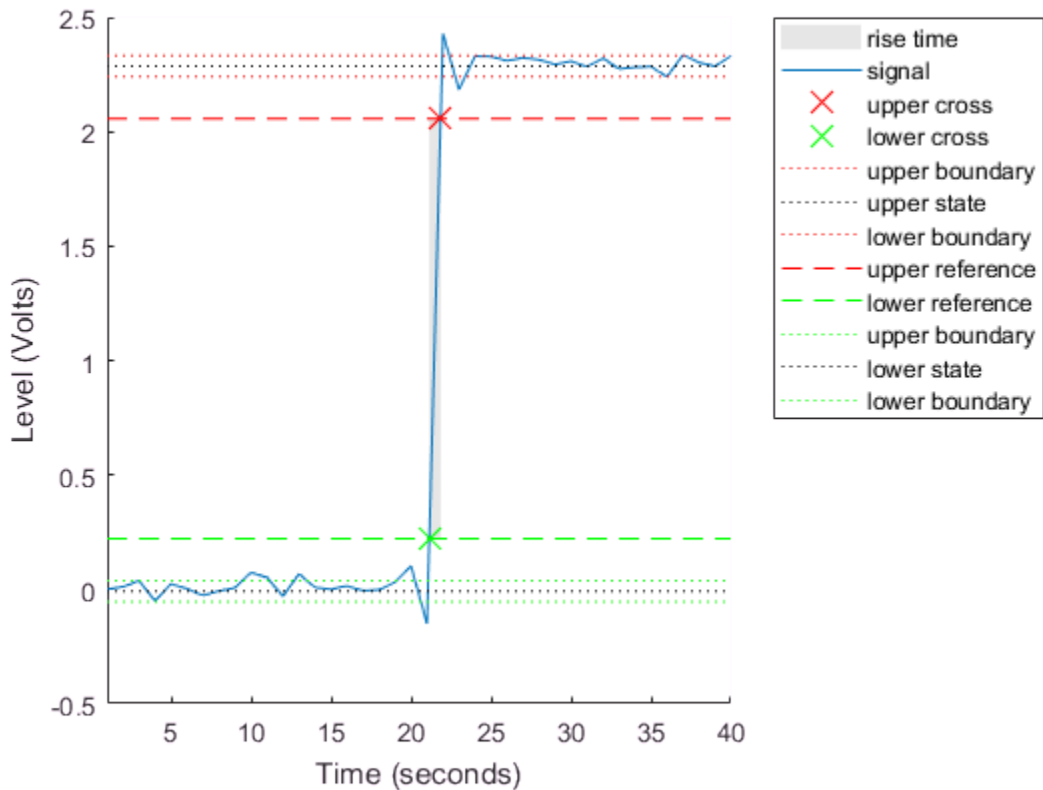



Rise Time with 20% and 80% Reference Levels

Determine the rise time in a 2.3 V clock waveform sampled at 4 MHz. Compute the rise time using the 20% and 80% reference levels.

Load the 2.3 V clock data with sampling instants. Determine the rise time using the 20% and 80% reference levels. Plot the annotated waveform.

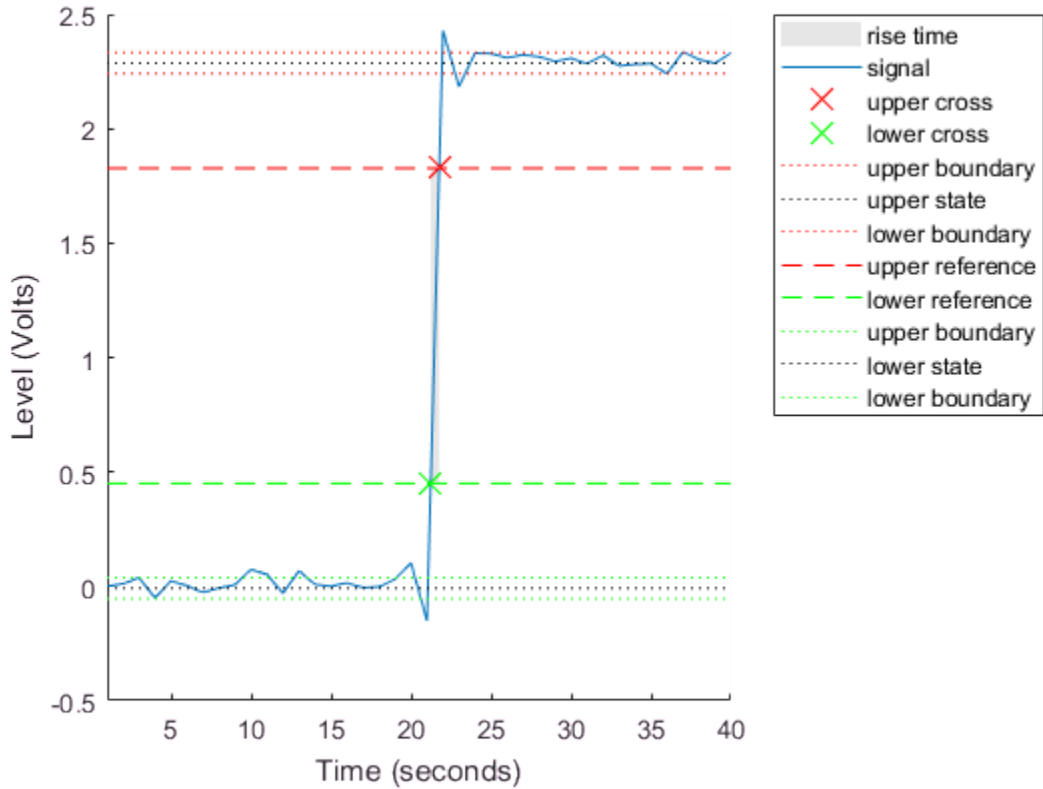
```
load('transitionex.mat','x','t')
risetime(x,'PercentReferenceLevels',[20 80])
ans = 0.5340
```



Rise Time, Reference-Level Instants, and Reference Levels

Determine the rise time, reference-level instants, and reference levels in a 2.3 V clock waveform sampled at 4 MHz.

Load the 2.3 V clock waveform along with the sampling instants.

```
load('transitionex.mat','x','t')
```

Determine the rise time, reference-level instants, and reference levels.

```
[R,lt,ut,ll,ul] = risetime(x,t);
```

Plot the waveform with the lower- and upper-reference levels and reference-level instants. Show that the rise time is the difference between the upper- and lower-reference level instants.

```
plot(t,x)
xlabel('seconds')
ylabel('Volts')

hold on
plot([lt ut],[ll ul],'o')
hold off
```

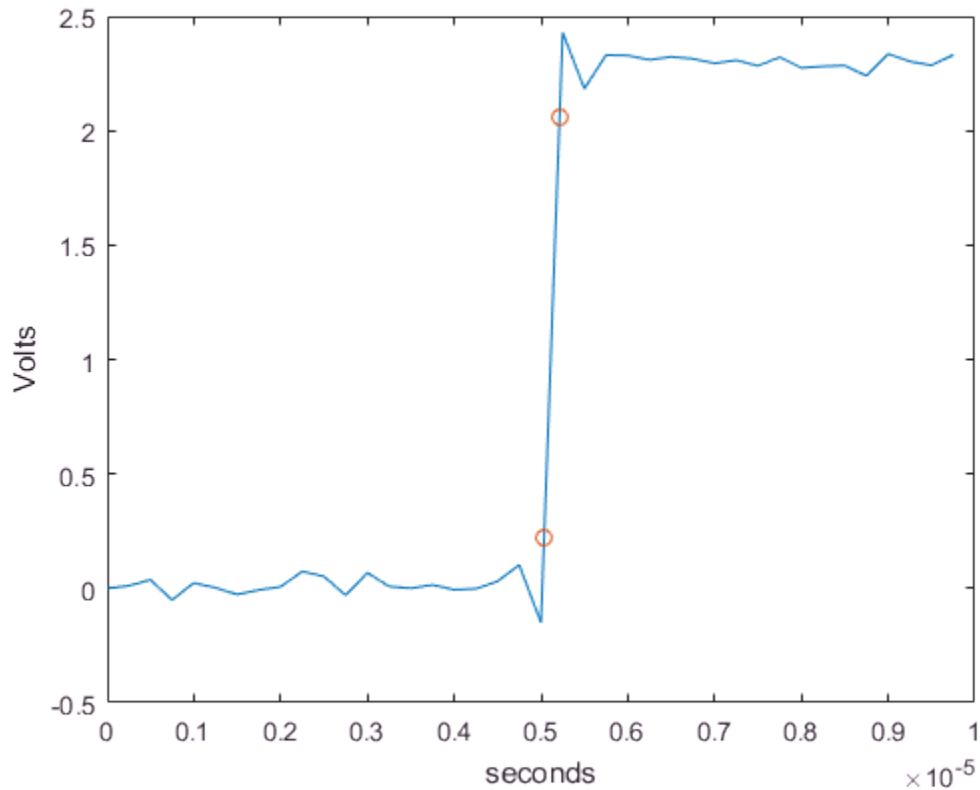

```
fprintf('Rise time is %g seconds.',ut-lt)
```

Rise time is 1.78e-07 seconds.

Definitions

Positive-Going Transition

A *positive-going transition* in a bilevel waveform is a transition from the low-state level to the high-state level. A positive-polarity (positive-going) pulse has a terminating state more positive than the originating state. If the waveform is differentiable in the neighborhood of the transition, an equivalent definition is a transition with a positive first derivative. The following figure shows a positive-going transition.

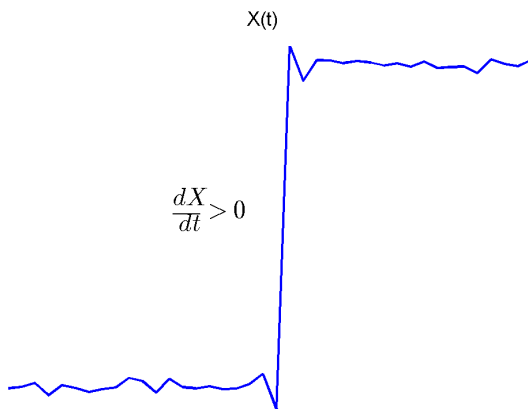

In the preceding figure, the amplitude values of the waveform do not appear because a positive-going transition does not depend on the actual waveform values. A positive-going transition is defined by the direction of the transition.

Percent Reference Levels

If S_1 is the low state, S_2 is the high state, and U is the *upper*-percent reference level. The waveform value corresponding to the upper percent reference level is

$$S_1 + \frac{U}{100}(S_2 - S_1).$$

If L is the *lower*-percent reference level, the waveform value corresponding to the lower percent reference level is

$$S_1 + \frac{L}{100}(S_2 - S_1).$$

State-Level Tolerances

Each state level can have associated lower- and upper-state boundaries. These state boundaries are defined as the state level plus or minus a scalar multiple of the difference between the high state and the low state. To provide a useful tolerance region, the scalar is typically a small number such as 2/100 or 3/100. In general, the $\alpha\%$ region for the low state is defined as

$$S_1 \pm \frac{\alpha}{100}(S_2 - S_1),$$

where S_1 is the low-state level and S_2 is the high-state level. Replace the first term in the equation with S_2 to obtain the $\alpha\%$ tolerance region for the high state.

The following figure illustrates lower and upper 2% state boundaries (tolerance regions) for a positive-polarity bilevel waveform. The red dashed lines indicate the estimated state levels.

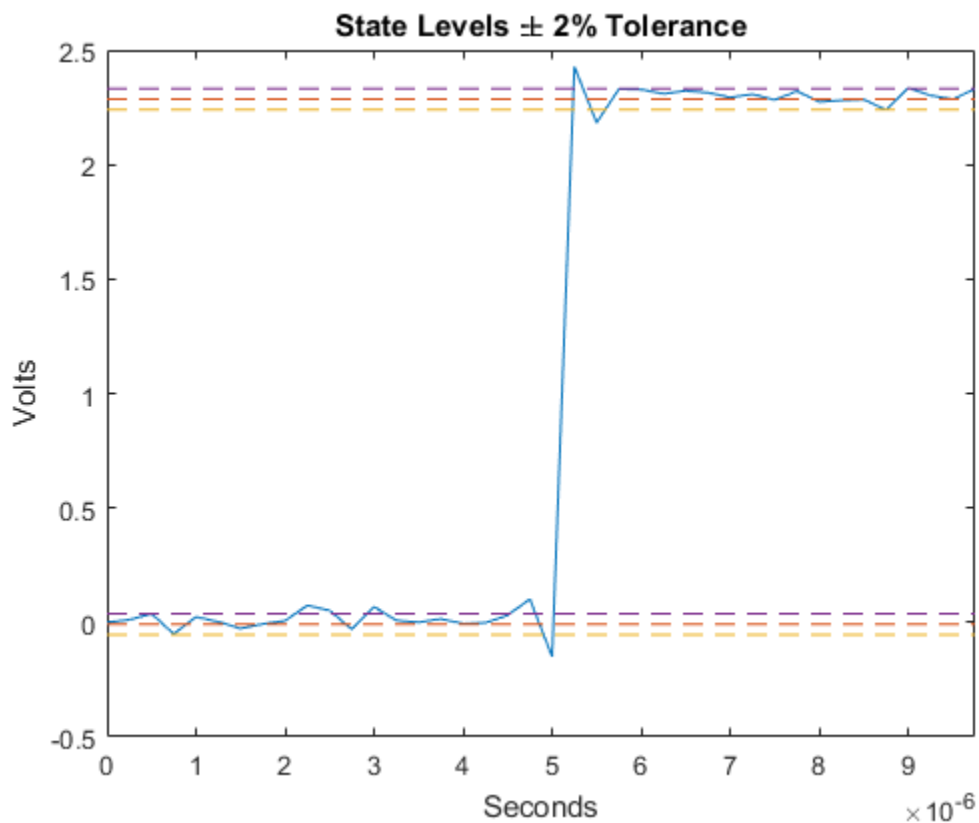

References

- [1] *IEEE Standard on Transitions, Pulses, and Related Waveforms*, IEEE Standard 181, 2003, pp. 15–17.

See Also

See Also

falltime | slewrate | statelevels

Introduced in R2012a

rlevinson

Reverse Levinson-Durbin recursion

Syntax

```
r = rlevinson(a,efinal)
[r,u] = rlevinson(a,efinal)
[r,u,k] = rlevinson(a,efinal)
[r,u,k,e] = rlevinson(a,efinal)
```

Description

The reverse Levinson-Durbin recursion implements the step-down algorithm for solving the following symmetric Toeplitz system of linear equations for r , where $r = [r(1) \dots r(p+1)]$ and $r(i)^*$ denotes the complex conjugate of $r(i)$.

$$\begin{bmatrix} r(1) & r(2)^* & \dots & r(p)^* \\ r(2) & r(1) & \dots & r(p-1)^* \\ \vdots & \ddots & \ddots & \vdots \\ r(p) & \dots & r(2) & r(1) \end{bmatrix} \begin{bmatrix} a(2) \\ a(3) \\ \vdots \\ a(p+1) \end{bmatrix} = \begin{bmatrix} -r(2) \\ -r(3) \\ \vdots \\ -r(p+1) \end{bmatrix}$$

`r = rlevinson(a,efinal)` solves the above system of equations for r given vector a , where $a = [1 \ a(2) \dots a(p+1)]$. In linear prediction applications, r represents the autocorrelation sequence of the input to the prediction error filter, where $r(1)$ is the zero-lag element. The figure below shows the typical filter of this type, where $H(z)$ is the optimal linear predictor, $x(n)$ is the input signal, $\hat{x}(n)$ is the predicted signal, and $e(n)$ is the prediction error.

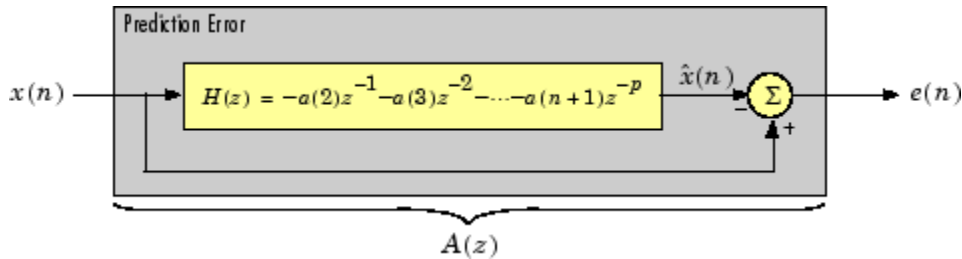

Input vector a represents the polynomial coefficients of this prediction error filter in descending powers of z .

$$A(z) = 1 + a(2)z^{-1} + \dots + a(n+1)z^{-p}$$

The filter must be minimum-phase to generate a valid autocorrelation sequence. `efinal` is the scalar prediction error power, which is equal to the variance of the prediction error signal, $\sigma^2(e)$.

`[r,u] = rlevinson(a,efinal)` returns upper triangular matrix U from the UDU^* decomposition

$$R^{-1} = UE^{-1}U^*$$

where

$$R = \begin{bmatrix} r(1) & r(2)^* & \dots & r(p)^* \\ r(2) & r(1) & \dots & r(p-1)^* \\ \vdots & \ddots & \ddots & \vdots \\ r(p) & \dots & r(2) & r(1) \end{bmatrix}$$

and E is a diagonal matrix with elements returned in output e (see below). This decomposition permits the efficient evaluation of the inverse of the autocorrelation matrix, R^{-1} .

Output matrix u contains the prediction filter polynomial, a , from each iteration of the reverse Levinson-Durbin recursion

$$U = \begin{bmatrix} a_1(1)^* & a_2(2)^* & \cdots & a_{p+1}(p+1)^* \\ 0 & a_2(1)^* & \ddots & a_{p+1}(p)^* \\ 0 & 0 & \ddots & a_{p+1}(p-1)^* \\ \vdots & \ddots & \ddots & \vdots \\ 0 & \cdots & 0 & a_{p+1}(1)^* \end{bmatrix}$$

where $a_i(j)$ is the j th coefficient of the i th order prediction filter polynomial (i.e., step i in the recursion). For example, the 5th order prediction filter polynomial is

```
a5 = u(5:-1:1,5)'
```

Note that `u(p+1:-1:1,p+1)'` is the input polynomial coefficient vector `a`.

`[r,u,k] = rlevinson(a,efinal)` returns a vector `k` of length $p + 1$ containing the reflection coefficients. The reflection coefficients are the conjugates of the values in the first row of `u`.

```
k = conj(u(1,2:end))
```

`[r,u,k,e] = rlevinson(a,efinal)` returns a vector of length $p + 1$ containing the prediction errors from each iteration of the reverse Levinson-Durbin recursion: `e(1)` is the prediction error from the first-order model, `e(2)` is the prediction error from the second-order model, and so on.

These prediction error values form the diagonal of the matrix E in the UDU^* decomposition of R^{-1} .

$$R^{-1} = UE^{-1}U^*$$

Examples

Optimum Autoregressive Model Order

Estimate the spectrum of two sine waves in noise using an autoregressive model. Choose the best model order from a group of models returned by the reverse Levinson-Durbin recursion.

Generate the signal. Specify a sample rate of 1 kHz and a signal duration of 50 seconds. The sinusoids have frequencies of 50 Hz and 55 Hz. The noise has a variance of 0.2^2 .

```
Fs = 1000;
t = (0:50e3-1)'/Fs;
x = sin(2*pi*50*t) + sin(2*pi*55*t) + 0.2*randn(50e3,1);
```

Estimate the autoregressive model parameters.

```
[a,e] = arcov(x,100);
[r,u,k] = rlevinson(a,e);
```

Estimate the power spectral density for orders 1, 5, 25, 50, and 100.

```
N = [1 5 25 50 100];
nFFT = 8096;
P = zeros(nFFT,5);

for idx = 1:numel(N)
    order = N(idx);
    ARtest = flipud(u(:,order));
    P(:,idx) = 1./abs(fft(ARtest,nFFT)).^2;
end
```

Plot the PSD estimates.

```
F = (0:1/nFFT:1/2-1/nFFT)*Fs;
plot(F, 10*log10(P(1:length(P)/2,:)))
grid

legend([repmat('Order = ',[5 1]) num2str(N')])
xlabel('Frequency (Hz)')
ylabel('dB')
xlim([35 70])
```

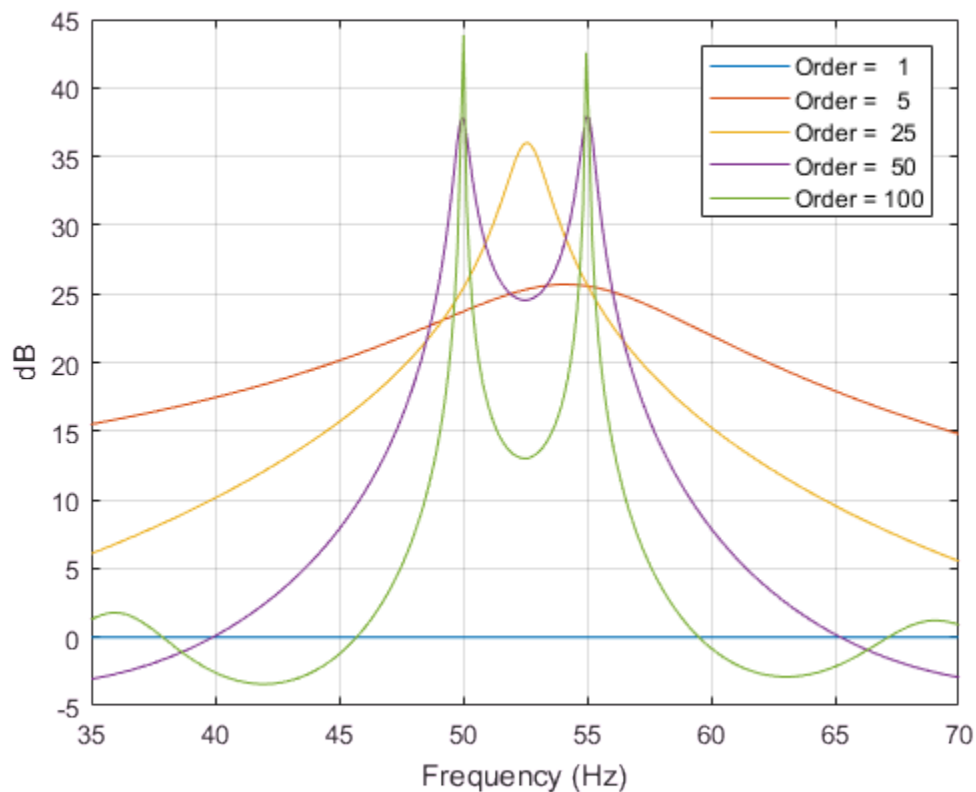

References

- [1] Kay, Steven M. *Modern Spectral Estimation: Theory and Application*. Englewood Cliffs, NJ: Prentice-Hall, 1988.

See Also

levinson | lpc | prony | stmcb

Introduced before R2006a

rms

Root-mean-square level

Syntax

$Y = \text{rms}(X)$

$Y = \text{rms}(X, \text{DIM})$

Description

$Y = \text{rms}(X)$ returns the root-mean-square (RMS) level of the input, X . If X is a row or column vector, Y is a real-valued scalar. For matrices, Y contains the RMS levels computed along the first nonsingleton dimension. For example, if X is an N -by- M matrix with $N > 1$, Y is a 1-by- M row vector containing the RMS levels of the columns of X .

$Y = \text{rms}(X, \text{DIM})$ computes the RMS level of X along the dimension, DIM .

Input Arguments

X

Real or complex-valued input vector or matrix. By default, `rms` acts along the first nonsingleton dimension of X .

DIM

Dimension for RMS levels. The optional DIM input argument specifies the dimension along which to compute the RMS levels.

Default: First nonsingleton dimension

Output Arguments

Y

Root-mean-square level. For vectors, Y is a real-valued scalar. For matrices, Y contains the RMS levels computed along the specified dimension DIM. By default, DIM is the first nonsingleton dimension.

Examples

RMS Level of Sinusoid

Compute the RMS level of a 100 Hz sinusoid sampled at 1 kHz.

```
t = 0:0.001:1-0.001;  
x = cos(2*pi*100*t);
```

```
y = rms(x)
```

```
y = 0.7071
```

RMS Levels of 2-D Matrix

Create a matrix where each column is a 100 Hz sinusoid sampled at 1 kHz with a different amplitude. The amplitude is equal to the column index.

Compute the RMS levels of the columns.

```
t = 0:0.001:1-0.001;  
x = cos(2*pi*100*t)'*(1:4);
```

```
y = rms(x)
```

```
y =
```

```
    0.7071    1.4142    2.1213    2.8284
```

RMS Levels of 2-D Matrix Along Specified Dimension

Create a matrix where each row is a 100 Hz sinusoid sampled at 1 kHz with a different amplitude. The amplitude is equal to the row index.

Compute the RMS levels of the rows specifying the dimension equal to 2 with the DIM argument.

```
t = 0:0.001:1-0.001;  
x = (1:4)' * cos(2*pi*100*t);
```

```
y = rms(x,2)
```

```
y =
```

```
0.7071  
1.4142  
2.1213  
2.8284
```

Definitions

Root-Mean-Square Level

The root-mean-square level of a vector, X , is

$$X_{\text{RMS}} = \sqrt{\frac{1}{N} \sum_{n=1}^N |X_n|^2},$$

with the summation performed along the specified dimension.

References

[1] *IEEE Standard on Transitions, Pulses, and Related Waveforms*, IEEE Std 181, 2003.

Extended Capabilities

C/C++ Code Generation

Generate C and C++ code using MATLAB® Coder™.

See Also

See Also

mean | peak2peak | peak2rms | rssq | std

Introduced in R2012a

rooteig

Frequency and power content using eigenvector method

Syntax

```
[w,pow] = rooteig(x,p)
[f,pow] = rooteig(...,fs)
[w,pow] = rooteig(...,'corr')
```

Description

`[w,pow] = rooteig(x,p)` estimates the frequency content in the time samples of a signal x , and returns w , a vector of frequencies in rad/sample, and the corresponding signal power in the vector pow in units of power, such as volts². The input signal x is specified either as:

- A row or column vector representing one observation of the signal
- A rectangular array for which each row of x represents a separate observation of the signal (for example, each row is one output of an array of sensors, as in array processing), such that $x' * x$ is an estimate of the correlation matrix

Note You can use the output of `corrmtx` to generate such an array x .

You can specify the second input argument p as either:

- A scalar integer. In this case, the signal subspace dimension is p .
- A two-element vector. In this case, $p(2)$, the second element of p , represents a threshold that is multiplied by λ_{\min} , the smallest estimated eigenvalue of the signal's correlation matrix. Eigenvalues below the threshold $\lambda_{\min} * p(2)$ are assigned to the noise subspace. In this case, $p(1)$ specifies the maximum dimension of the signal subspace.

The extra threshold parameter in the second entry in p provides you more flexibility and control in assigning the noise and signal subspaces.

The length of the vector `w` is the computed dimension of the signal subspace. For real-valued input data `x`, the length of the corresponding power vector `pow` is given by

```
length(pow) = 0.5*length(w)
```

For complex-valued input data `x`, `pow` and `w` have the same length.

`[f,pow] = rooteig(...,fs)` returns the vector of frequencies `f` calculated in Hz. You supply the sampling frequency `fs` in Hz. If you specify `fs` with the empty vector `[]`, the sampling frequency defaults to 1 Hz.

`[w,pow] = rooteig(...,'corr')` forces the input argument `x` to be interpreted as a correlation matrix rather than a matrix of signal data. For this syntax, you must supply a square matrix for `x`, and all of its eigenvalues must be nonnegative.

Note You can place 'corr' anywhere after `p`.

Examples

Frequency Content of Complex Exponentials

Find the frequency content in a signal composed of three complex exponentials in noise. Use the modified covariance method to estimate the correlation matrix used by the eigenvector method. Reset the random number generator for reproducible results.

```
rng default
n = 0:99;
s = exp(1i*pi/2*n)+2*exp(1i*pi/4*n)+exp(1i*pi/3*n)+randn(1,100);
```

```
X = corrmtx(s,12,'mod');
[W,P] = rooteig(X,3)
```

W =

```
0.7883
1.5674
1.0429
```

P =

4.1748
1.0572
1.2419

Algorithms

The eigenvector method used by `rooteig` is the same as that used by `peig`. The algorithm performs eigenspace analysis of the signal's correlation matrix in order to estimate the signal's frequency content.

The difference between `peig` and `rooteig` is:

- `peig` returns the pseudospectrum at all frequency samples.
- `rooteig` returns the estimated discrete frequency spectrum, along with the corresponding signal power estimates.

`rooteig` is most useful for frequency estimation of signals made up of a sum of sinusoids embedded in additive white Gaussian noise.

See Also

`peig` | `pmusic` | `corrmtx` | `rootmusic`

Introduced before R2006a

rootmusic

Root MUSIC algorithm

Syntax

```
W = rootmusic(X,P)
[W,POW] = rootmusic(X,P)
[F, POW] = rootmusic(...,Fs)
[W,POW] = rootmusic(...,'corr')
```

Description

`W = rootmusic(X,P)` returns the frequencies in radians/sample for the P complex exponentials (sinusoids) that make up the signal X .

The input X is specified either as:

- A row or column vector representing one realization of signal
- A rectangular array for which each row of X represents a separate observation of the signal (for example, each row is one output of an array of sensors, as in array processing), such that $X' * X$ is an estimate of the correlation matrix

`[W,POW] = rootmusic(X,P)` returns the estimated absolute value squared amplitudes of the sinusoids at the frequencies W .

The second input argument, P is the number of complex sinusoids in X . You can specify P as either:

- A positive integer. In this case, the signal subspace dimension is P .
- A two-element vector. In this case, $P(2)$, the second element of P , represents a threshold that is multiplied by λ_{\min} , the smallest estimated eigenvalue of the signal's correlation matrix. Eigenvalues below the threshold $\lambda_{\min} * P(2)$ are assigned to the noise subspace. In this case, $P(1)$ specifies the maximum dimension of the signal subspace.

The extra threshold parameter in the second entry in P provides you more flexibility and control in assigning the noise and signal subspaces.

The length of the vector W is the computed dimension of the signal subspace. For real-valued input data X , the length of the corresponding power vector POW is given by

$$\text{length}(POW) = 0.5 * \text{length}(W)$$

For complex-valued input data X , POW and W have the same length.

`[F, POW] = rootmusic(...,Fs)` returns the vector of frequencies F calculated in Hz. You supply the sampling frequency FS in Hz. If you specify FS with the empty vector `[]`, the sampling frequency defaults to 1 Hz.

`[W,POW] = rootmusic(...,'corr')` forces the input argument X to be interpreted as a correlation matrix rather than a matrix of signal data. For this syntax, you must supply a square matrix for X , and all of its eigenvalues must be nonnegative. You can place the 'corr' option anywhere after the P input argument.

Note You can use the output of `corrmtx` to generate such an array X .

Examples

Sinusoid Amplitudes

Estimate the amplitudes for two sinusoids in noise. The separation between the sinusoids is less than the resolution of the periodogram, $2\pi/N$ radians/sample. Use the autocorrelation matrix as the input to `rootmusic`.

```
rng default
n = (0:99)';
frqs = [pi/4 pi/4+0.06];

s = 2*exp(1j*frqs(1)*n)+1.5*exp(1j*frqs(2)*n)+ ...
    0.5*randn(100,1)+1j*0.5*randn(100,1);

[~,R] = corrmtx(s,12,'mod');
[W,P] = rootmusic(R,2,'corr')

W =

    0.7946
    0.8917
```

```
P =  
  
    4.1535  
    0.7797
```

Diagnostics

If the input signal, `x` is real and an odd number of sinusoids, `p` is specified, the following error message is displayed:

```
Real signals require an even number p of complex sinusoids.
```

Algorithms

The MUSIC algorithm used by `rootmusic` is the same as that used by `pmusic`. The algorithm performs eigenspace analysis of the signal's correlation matrix in order to estimate the signal's frequency content.

The difference between `pmusic` and `rootmusic` is:

- `pmusic` returns the pseudospectrum at all frequency samples.
- `rootmusic` returns the estimated discrete frequency spectrum, along with the corresponding signal power estimates.

`rootmusic` is most useful for frequency estimation of signals made up of a sum of sinusoids embedded in additive white Gaussian noise.

See Also

`corrmtx` | `peig` | `pmusic` | `rooteig`

Introduced before R2006a

rpmfreqmap

Frequency-RPM map for order analysis

Syntax

```
map = rpmfreqmap(x, fs, rpm)
map = rpmfreqmap(x, fs, rpm, res)

map = rpmfreqmap( ____, Name, Value)

[map, freq, rpm, time, res] = rpmfreqmap( ____ )

rpmfreqmap( ____ )
```

Description

`map = rpmfreqmap(x, fs, rpm)` returns the frequency-RPM map matrix, `map`, that results from performing frequency analysis on the input vector, `x`. `x` is measured at a set `rpm` of rotational speeds expressed in revolutions per minute. `fs` is the sample rate in Hz. Each column of `map` contains root-mean-square (RMS) amplitude estimates of the spectral content present at each value of `rpm`. `rpmfreqmap` uses the short-time Fourier transform to analyze the spectral content of `x`.

`map = rpmfreqmap(x, fs, rpm, res)` specifies the resolution bandwidth of the map in Hz.

`map = rpmfreqmap(____, Name, Value)` specifies options using `Name, Value` pairs in addition to the input arguments in previous syntaxes.

`[map, freq, rpm, time, res] = rpmfreqmap(____)` returns vectors with the frequencies, rotational speeds, and time instants at which the frequency map is computed. It also returns the resolution bandwidth used.

`rpmfreqmap(____)` with no output arguments plots the frequency map as a function of rotational speed and time on an interactive figure. The plot is also known as a *Campbell diagram*.

Examples

Frequency-RPM Map of Chirp with 4 Orders

Create a simulated signal sampled at 600 Hz for 5 seconds. The system that is being tested increases its rotational speed from 10 to 40 revolutions per second during the observation period.

Generate the tachometer readings.

```
fs = 600;  
t1 = 5;  
t = 0:1/fs:t1;  
  
f0 = 10;  
f1 = 40;  
rpm = 60*linspace(f0,f1,length(t));
```

The signal consists of four harmonically related chirps with orders 1, 0.5, 4, and 6. The order-4 chirp has twice the amplitude of the others. To generate the chirps, use the trapezoidal rule to express the phase as the integral of the rotational speed.

```
o1 = 1;  
o2 = 0.5;  
o3 = 4;  
o4 = 6;  
  
ph = 2*pi*cumtrapz(rpm/60)/fs;  
  
x = [1 1 2 1]*cos([o1 o2 o3 o4]'*ph);
```

Visualize the frequency-RPM map of the signal.

```
rpmfreqmap(x,fs,rpm)
```

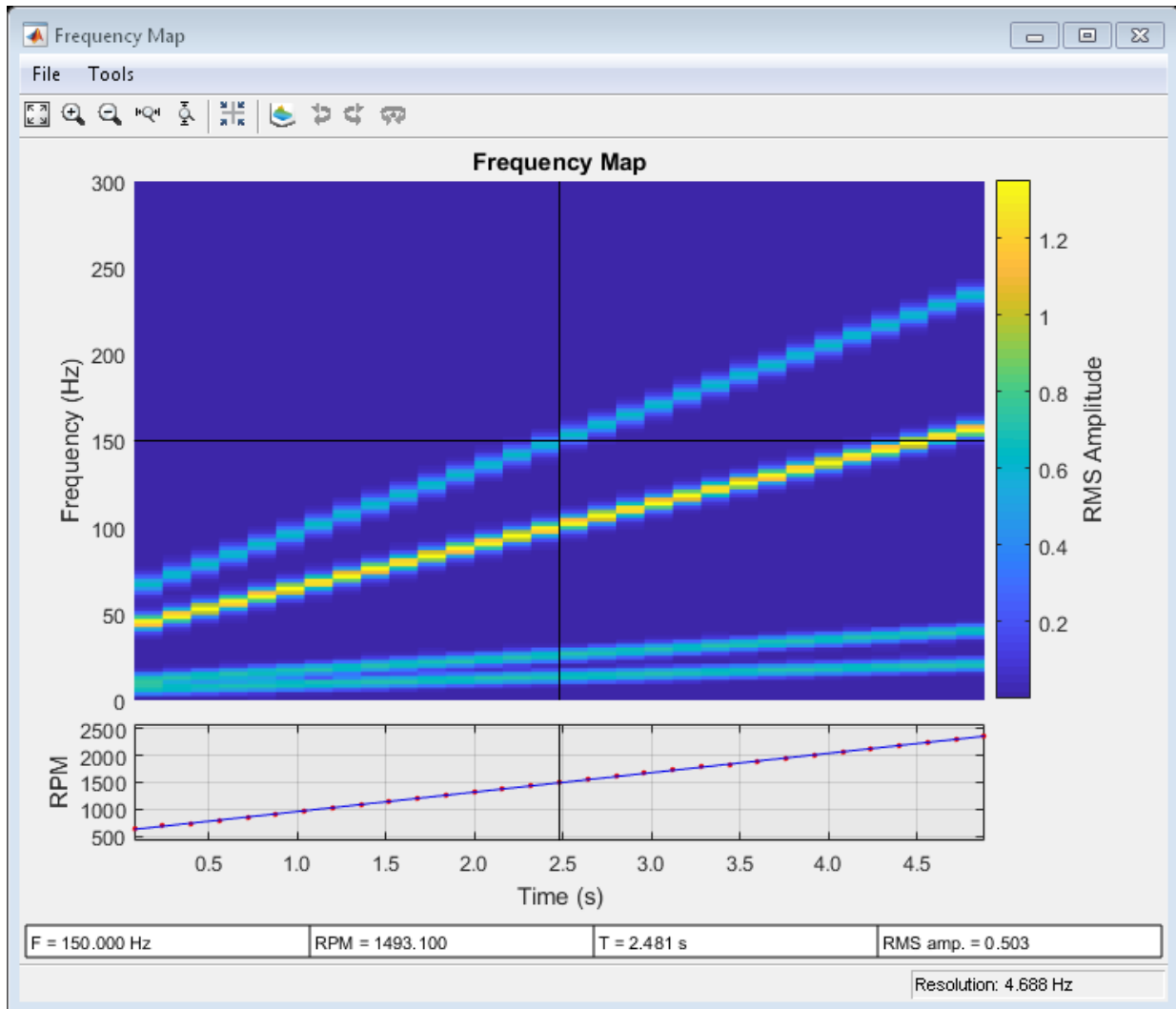
Frequency-RPM Map of Helicopter Vibration Data

Analyze simulated data from an accelerometer placed in the cockpit of a helicopter.

Load the helicopter data. The vibrational measurements, `vib`, are sampled at a rate of 500 Hz for 10 seconds. Inspection of the data reveals that it has a linear trend. Remove the trend to prevent it from degrading the quality of the frequency estimation.

```
load('helidata.mat')  
  
vib = detrend(vib);
```

Plot the nonlinear RPM profile. The rotor runs up until it reaches a maximum rotational speed of about 27,600 revolutions per minute and then coasts down.

```
plot(t,rpm)  
xlabel('Time (s)')  
ylabel('RPM')
```

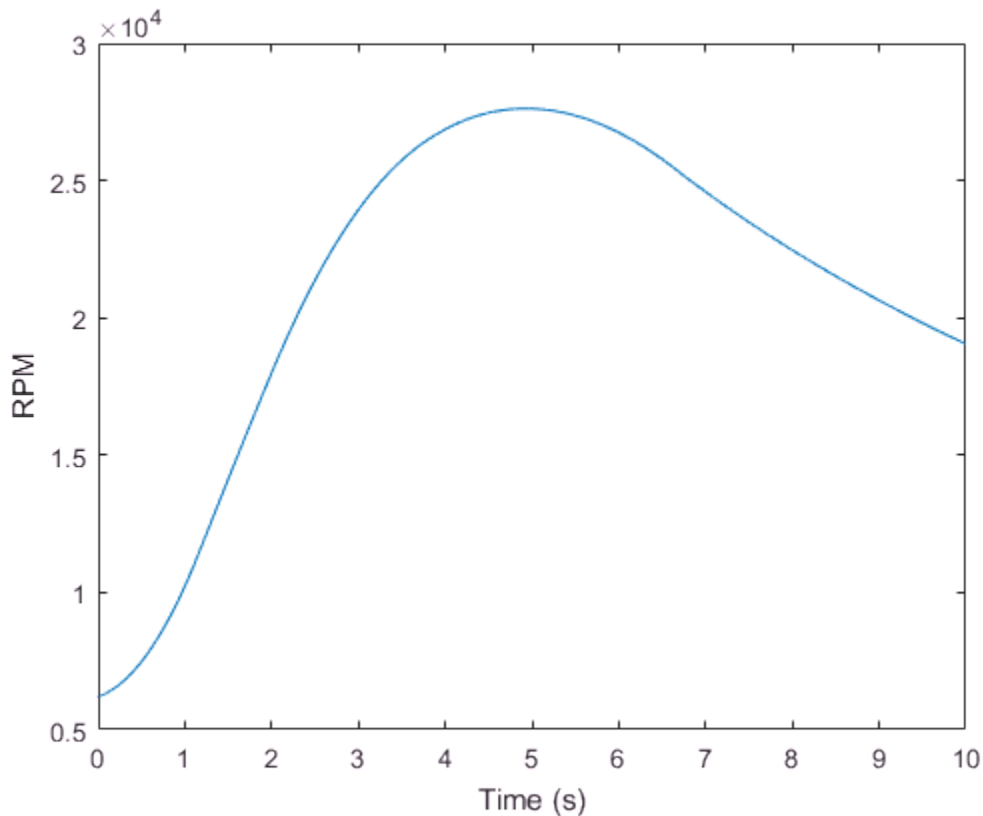

Compute the frequency-RPM map. Specify a resolution bandwidth of 2.5 Hz.

```
[map,freq,rpmOut,time] = rpmfreqmap(vib,fs,rpm,2.5);
```

Visualize the map.

```
imagesc(time,freq,map)
ax = gca;
ax.YDir = 'normal';
xlabel('Time (s)')
ylabel('Frequency (Hz)')
```

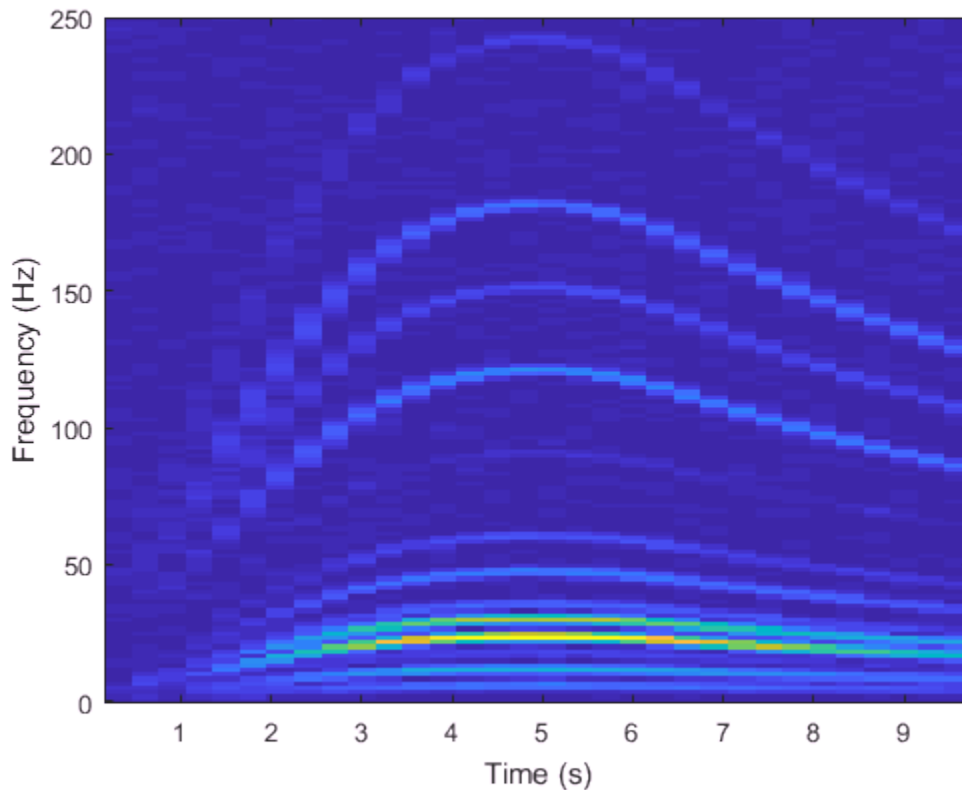

Repeat the computation using a finer resolution bandwidth. Plot the map using the built-in functionality of `rpmfreqmap`. The gain in frequency resolution comes at the expense of time resolution.

```
rpmfreqmap(vib, fs, rpm, 1.5);
```

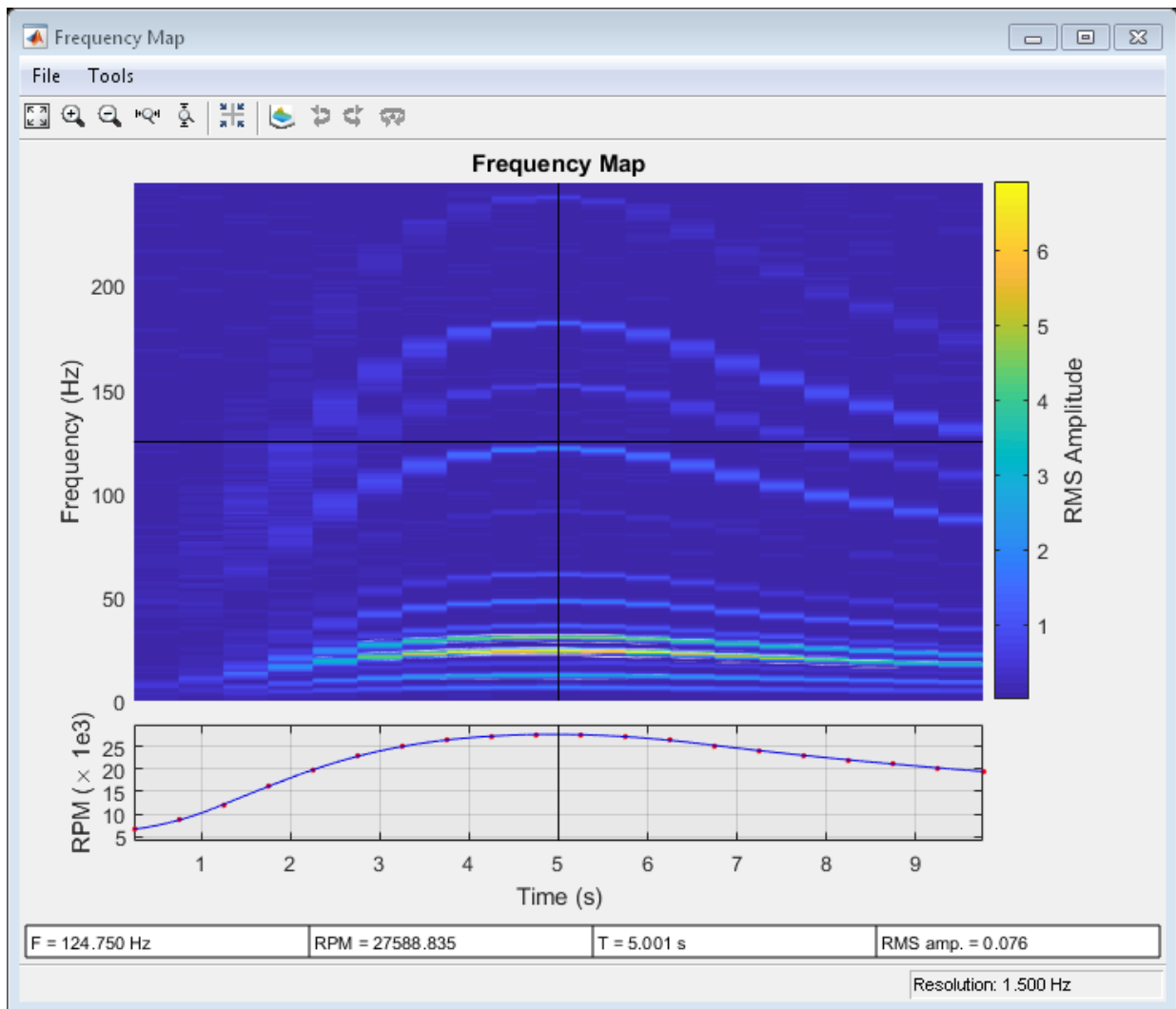

Waterfall Plot of Frequency-RPM Map

Generate a signal that consists of two linear chirps and a quadratic chirp, all sampled at 600 Hz for 15 seconds. The system that produces the signal increases its rotational speed from 10 to 40 revolutions per second during the testing period.

Generate the tachometer readings.

```
fs = 600;
t1 = 15;
t = 0:1/fs:t1;

f0 = 10;
f1 = 40;
rpm = 60*linspace(f0,f1,length(t));
```

The linear chirps have orders 1 and 2.5. The component with order 1 has half the amplitude of the other. The quadratic chirp starts at order 6 and returns to this order at the end of the measurement. Its amplitude is 0.8. Create the signal using this information.

```
o1 = 1;
o2 = 2.5;
o6 = 6;

x = 0.5*chirp(t,o1*f0,t1,o1*f1)+chirp(t,o2*f0,t1,o2*f1) + ...
    0.8*chirp(t,o6*f0,t1,o6*f1,'quadratic');
```

Compute the frequency-RPM map of the signal. Use the peak amplitude at each measurement cell. Specify a resolution of 6 Hz. Window the data with a flat top window.

```
[map,fr,rp] = rpmfreqmap(x,fs,rpm,6, ...
    'Amplitude','peak','Window','flattopwin');
```

Draw the frequency-RPM map as a waterfall plot.

```
[FR,RP] = meshgrid(fr,rp);
waterfall(FR,RP,map')

view(-6,60)
xlabel('Frequency (Hz)')
ylabel('RPM')
zlabel('Amplitude')
```

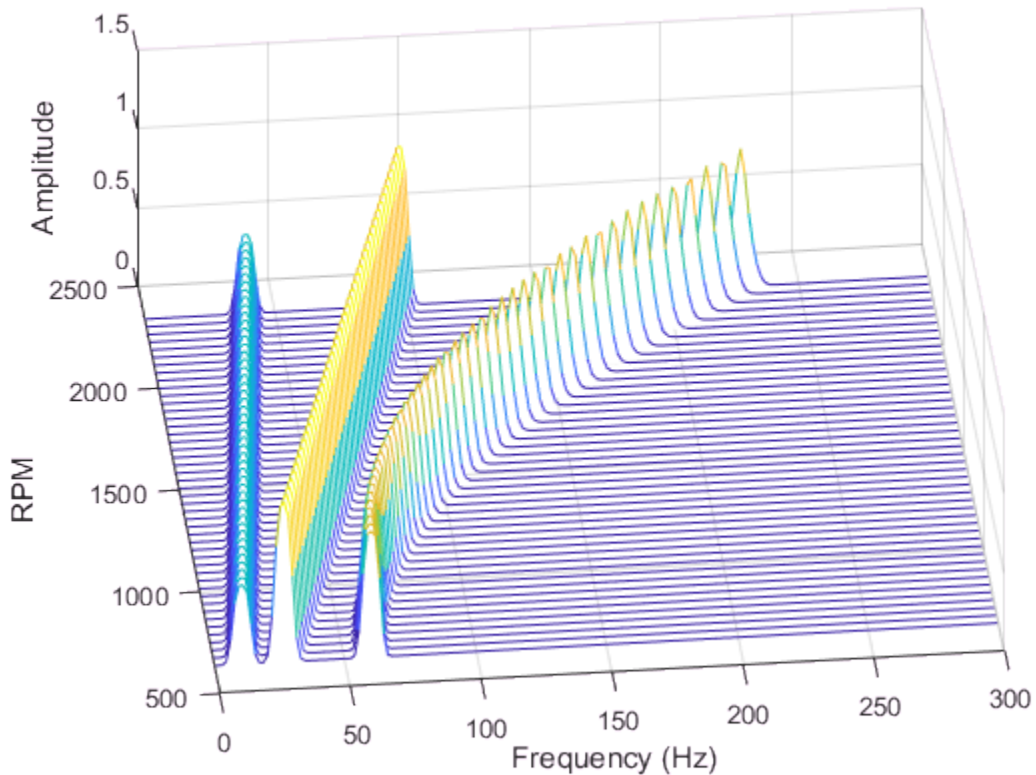

Interactive Frequency-RPM Map

Plot an interactive frequency-RPM map by calling `rpmfreqmap` without output arguments.

Load a file containing simulated vibrational data from an accelerometer placed in the cockpit of a helicopter. The data are sampled at a rate of 500 Hz for 10 seconds. Remove the linear trend in the data. Call `rpmfreqmap` to generate an interactive plot of the frequency-RPM map. Specify a frequency resolution of 2 Hz.

```
load helidata.mat
rpmfreqmap(detrend(vib), fs, rpm, 2)
```

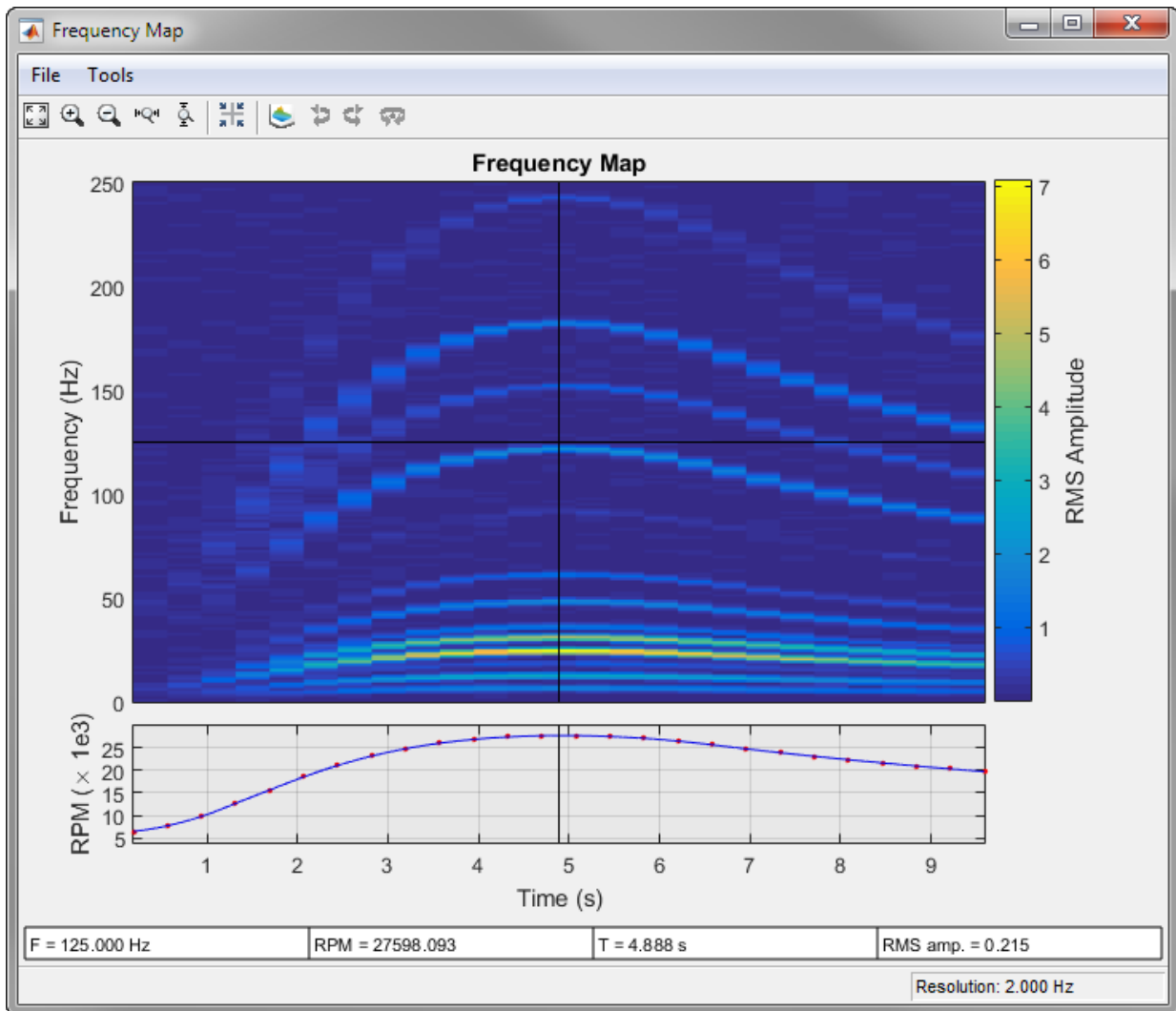

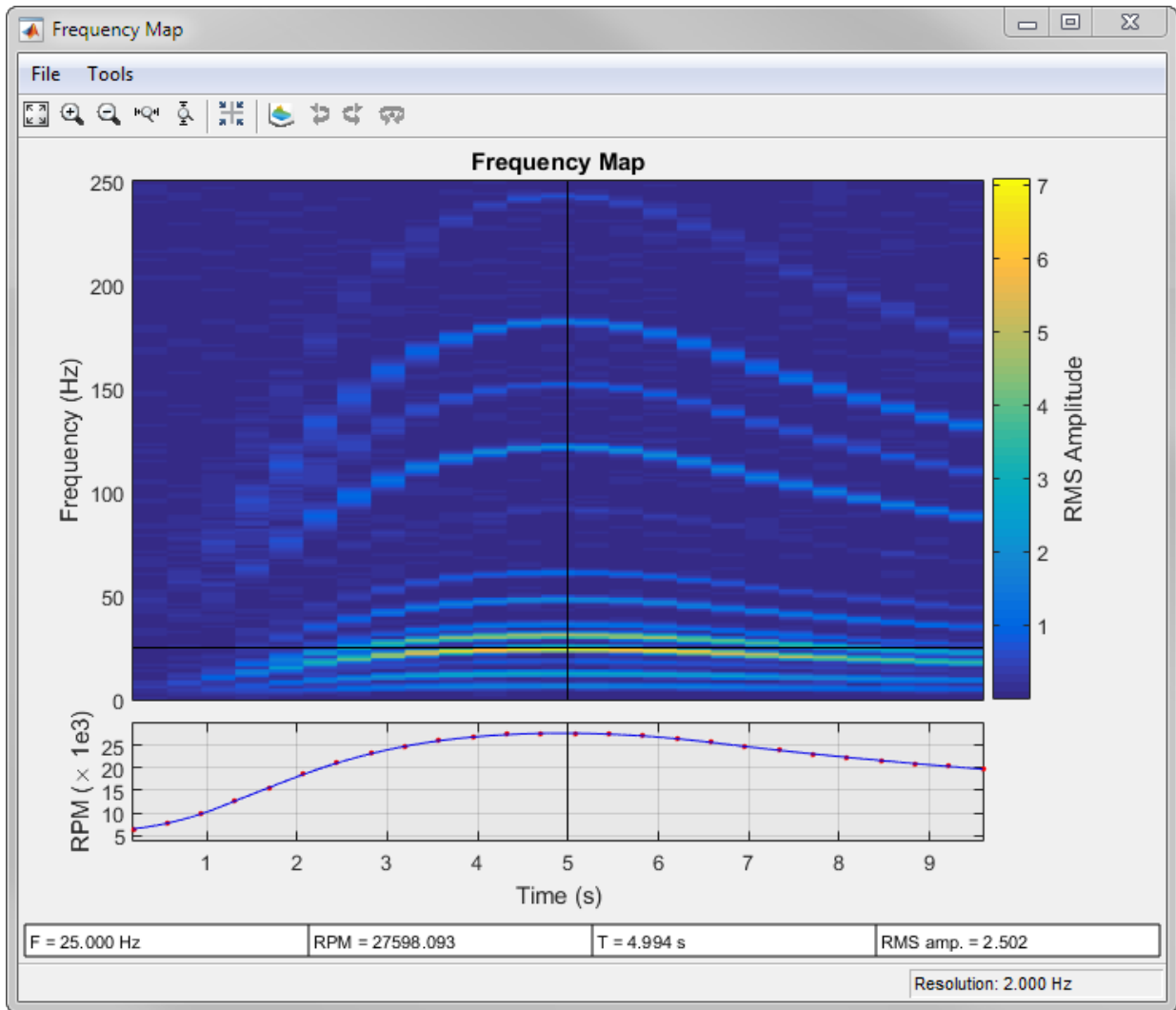

Move the crosshair cursors in the figure to determine the RPM and the RMS amplitude at a frequency of 25 Hz after 5 seconds.

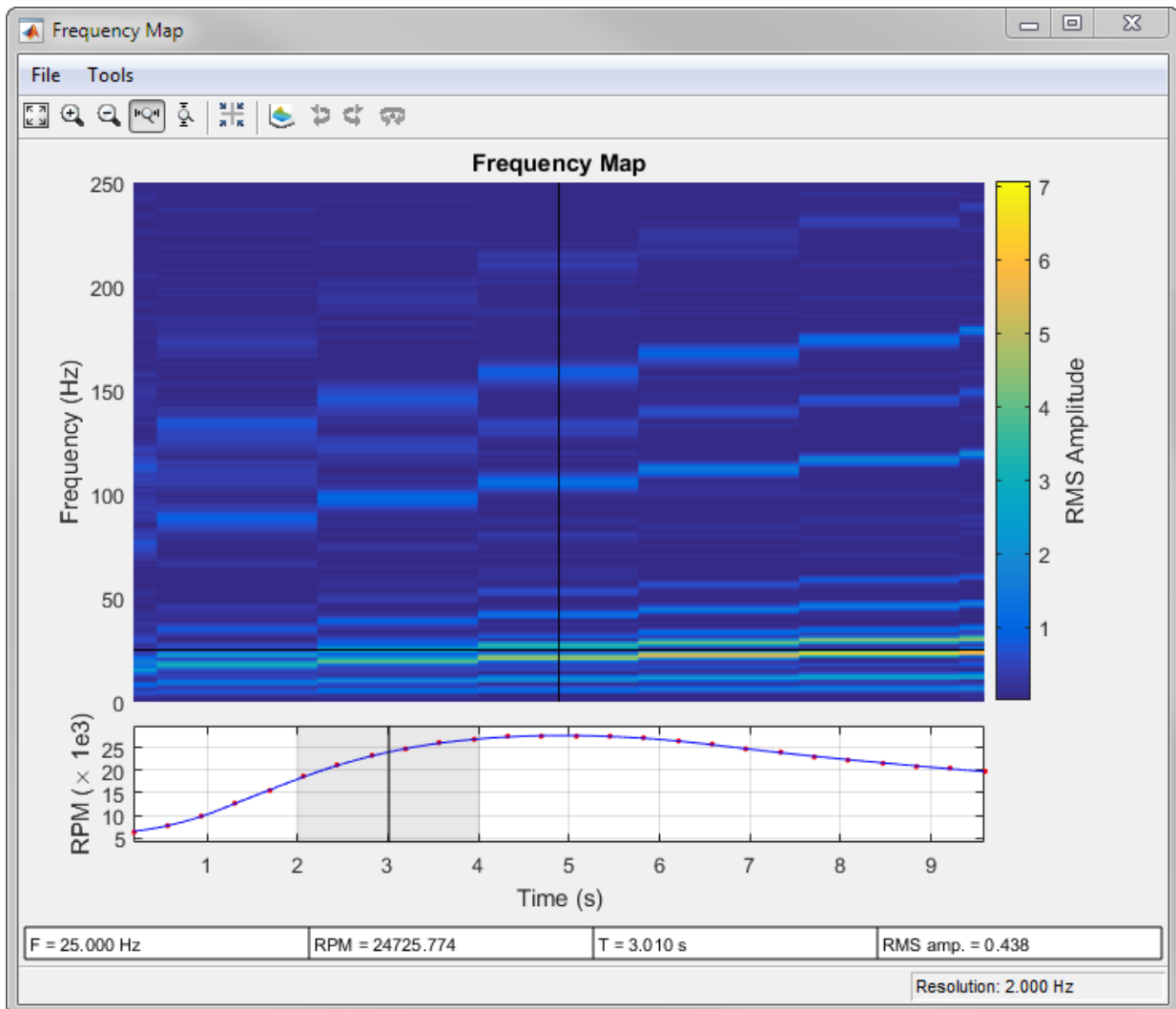

Click the **Zoom X** button  in the toolbar to zoom into the time region between 2 and 4 seconds. A panner appears in the bottom plot.



Click the **Waterfall Plot** button  in the toolbar to display the frequency-RPM map as a waterfall plot. For improved visibility, rotate the plot clockwise using the **Rotate Left** button  three times. Move the panner to the interval between 4 and 6 seconds.

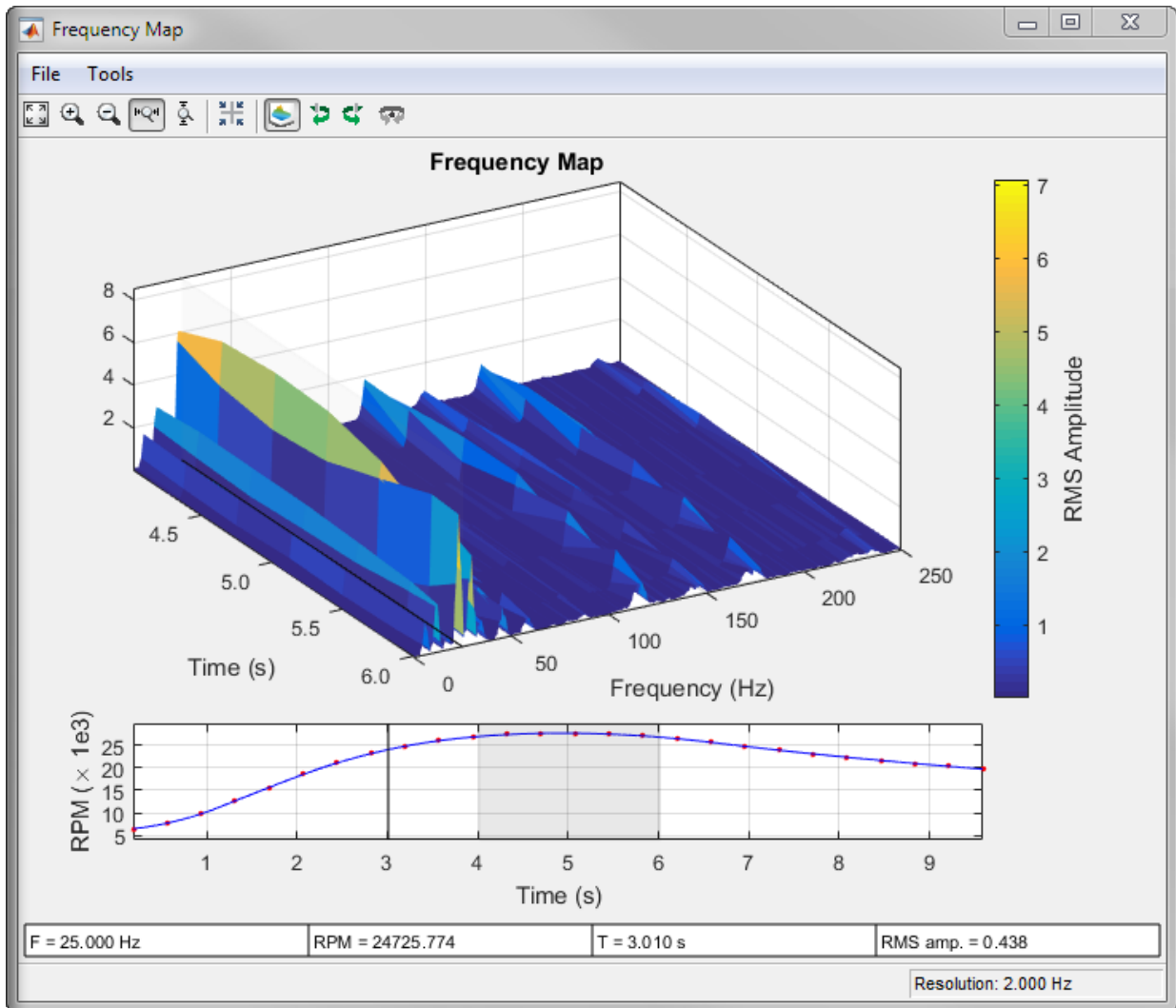

Input Arguments

x — Input signal
vector

Input signal, specified as a row or column vector.

Example: `cos(pi/4*(0:159))+randn(1,160)` specifies a sinusoid embedded in white Gaussian noise.

Data Types: `double` | `single`

fs — Sample rate

positive scalar

Sample rate, specified as a positive scalar expressed in Hz.

Data Types: `double` | `single`

rpm — Rotational speeds

vector of positive values

Rotational speeds, specified as a vector of positive values expressed in revolutions per minute. `rpm` must have the same length as `x`.

Example: `100:10:3000` specifies that a system rotates initially at 100 revolutions per minute and runs up to 3000 revolutions per minute in increments of 10.

Data Types: `double` | `single`

res — Resolution bandwidth

`fs/128` (default) | positive scalar

Resolution bandwidth of the frequency-RPM map, specified as a positive scalar. If `res` is not specified, then `rpmfreqmap` sets it to the sample rate divided by 128. If the signal is not long enough, then the function uses the entire signal length to compute a single frequency estimate.

Data Types: `single` | `double`

Name-Value Pair Arguments

Specify optional comma-separated pairs of `Name`, `Value` arguments. `Name` is the argument name and `Value` is the corresponding value. `Name` must appear inside single quotes (' '). You can specify several name and value pair arguments in any order as `Name1`, `Value1`, ..., `NameN`, `ValueN`.

Example: `'Scale','dB','Window','hann'` specifies that the frequency map estimates are to be scaled in decibels and determined using a Hann window.

'Amplitude' — Frequency-RPM map amplitudes

'rms' (default) | 'peak' | 'power'

Frequency-RPM map amplitudes, specified as the comma-separated pair consisting of 'Amplitude' and one of 'rms', 'peak', or 'power'.

- 'rms' — Returns the root-mean-square amplitude for each estimated frequency.
- 'peak' — Returns the peak amplitude for each estimated frequency.
- 'power' — Returns the power level for each estimated frequency.

Data Types: char

'OverlapPercent' — Overlap percentage between adjoining segments

50 (default) | scalar from 0 to 100

Overlap percentage between adjoining segments, specified as the comma-separated pair consisting of 'OverlapPercent' and a scalar from 0 to 100. A value of 0 means that adjoining segments do not overlap. A value of 100 means that adjoining segments are shifted by one sample. A larger overlap percentage produces a smoother map but increases the computation time. See `rpmordermap` for more information.

Data Types: double | single

'Scale' — Frequency-RPM map scaling

'linear' (default) | 'dB'

Frequency-RPM map scaling, specified as the comma-separated pair consisting of 'Scale' and either 'linear' or 'dB'.

- 'linear' — Returns a linearly scaled map.
- 'dB' — Returns a logarithmic map with values expressed in decibels.

Data Types: char

'Window' — Analysis window

'hann' (default) | 'chebwin' | 'flattopwin' | 'hamming' | 'kaiser' | 'rectwin'

Analysis window, specified as the comma-separated pair consisting of 'Window' and one of these values:

- 'hann' specifies a Hann window. See `hann` for more details.

- 'chebwin' specifies a Chebyshev window. Use a cell array to specify a sidelobe attenuation in decibels. The sidelobe attenuation must be greater than 45 dB. If not specified, it defaults to 100 dB. See `chebwin` for more details.
- 'flattopwin' specifies a flat top window. See `flattopwin` for more details.
- 'hamming' specifies a Hamming window. See `hamming` for more details.
- 'kaiser' specifies a Kaiser window. Use a cell array to specify a shape parameter, β . The shape parameter must be a positive scalar. If not specified, it defaults to 0.5. See `kaiser` for more details.
- 'rectwin' specifies a rectangular window. See `rectwin` for more details.

Example: 'Window', 'chebwin' specifies a Chebyshev window with a sidelobe attenuation of 100 dB.

Example: 'Window', {'chebwin', 60} specifies a Chebyshev window with a sidelobe attenuation of 60 dB.

Example: 'Window', 'kaiser' specifies a Kaiser window with a shape parameter of 0.5.

Example: 'Window', {'kaiser', 1} specifies a Kaiser window with a shape parameter of 1.

Data Types: char | cell

Output Arguments

map — Frequency-RPM map

matrix

Frequency-RPM map, returned as a matrix.

freq — Frequencies

vector

Frequencies, returned as a vector.

rpm — Rotational speeds

vector

Rotational speeds, returned as a vector.

time — Time instants

vector

Time instants, returned as a vector.

res — Resolution bandwidth

scalar

Resolution bandwidth, returned as a scalar.

References

- [1] Brandt, Anders. *Noise and Vibration Analysis: Signal Analysis and Experimental Procedures*. Chichester, UK: John Wiley & Sons, 2011.

See Also

See Also

orderspectrum | ordertrack | orderwaveform | rpmordermap | spectrogram | tachorpm

Introduced in R2015b

rpmordermap

Order-RPM map for order analysis

Syntax

```
map = rpmordermap(x, fs, rpm)
map = rpmordermap(x, fs, rpm, res)

map = rpmordermap( ____, Name, Value)

[map, order, rpm, time, res] = rpmordermap( ____ )

rpmordermap( ____ )
```

Description

`map = rpmordermap(x, fs, rpm)` returns the order-RPM map matrix, `map`, that results from performing order analysis on the input vector, `x`. `x` is measured at a set `rpm` of rotational speeds expressed in revolutions per minute. `fs` is the measurement sample rate in Hz. Each column of `map` contains root-mean-square (RMS) amplitude estimates of the orders present at each `rpm` value. `rpmordermap` resamples `x` to a constant samples-per-cycle rate and uses the short-time Fourier transform to analyze the spectral content of the resampled signal.

`map = rpmordermap(x, fs, rpm, res)` specifies the order resolution of the map in units of orders.

`map = rpmordermap(____, Name, Value)` specifies options using `Name, Value` pairs in addition to the input arguments in previous syntaxes.

`[map, order, rpm, time, res] = rpmordermap(____)` returns vectors with the orders, rotational speeds, and time instants at which the order map is computed. It also returns the order resolution used.

`rpmordermap(____)` with no output arguments plots the order map as a function of rotational speed and time on an interactive figure.

Examples

Order-RPM Map of Chirp with 4 Orders

Create a simulated signal sampled at 600 Hz for 5 seconds. The system that is being tested increases its rotational speed from 10 to 40 revolutions per second during the observation period.

Generate the tachometer readings.

```
fs = 600;  
t1 = 5;  
t = 0:1/fs:t1;  
  
f0 = 10;  
f1 = 40;  
rpm = 60*linspace(f0,f1,length(t));
```

The signal consists of four harmonically related chirps with orders 1, 0.5, 4, and 6. The order-4 chirp has twice the amplitude of the others. To generate the chirps, use the trapezoidal rule to express the phase as the integral of the rotational speed.

```
o1 = 1;  
o2 = 0.5;  
o3 = 4;  
o4 = 6;  
  
ph = 2*pi*cumtrapz(rpm/60)/fs;  
  
x = [1 1 2 1]*cos([o1 o2 o3 o4]'*ph);
```

Visualize the order-RPM map of the signal.

```
rpmordermap(x,fs,rpm)
```

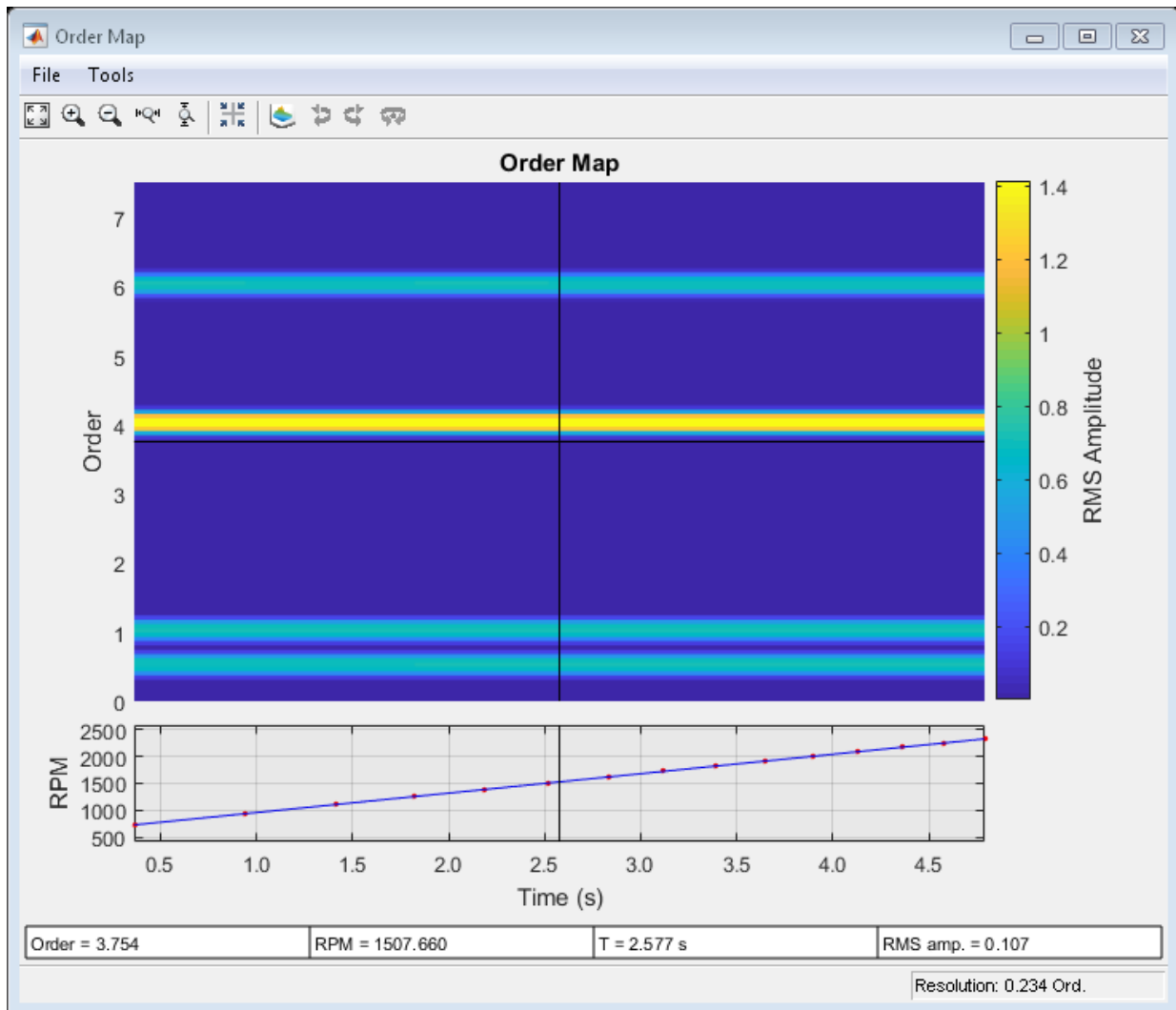
Order-RPM Map of Helicopter Vibration Data

Analyze simulated data from an accelerometer placed in the cockpit of a helicopter.

Load the helicopter data. The vibrational measurements, `vib`, are sampled at a rate of 500 Hz for 10 seconds. Inspection of the data reveals that it has a linear trend. Remove the trend to prevent it from degrading the quality of the order estimation.

```
load('helidata.mat')
```

```
vib = detrend(vib);
```

Plot the nonlinear RPM profile. The rotor runs up until it reaches a maximum rotational speed of about 27,600 revolutions per minute and then coasts down.

```
plot(t,rpm)
xlabel('Time (s)')
ylabel('RPM')
```

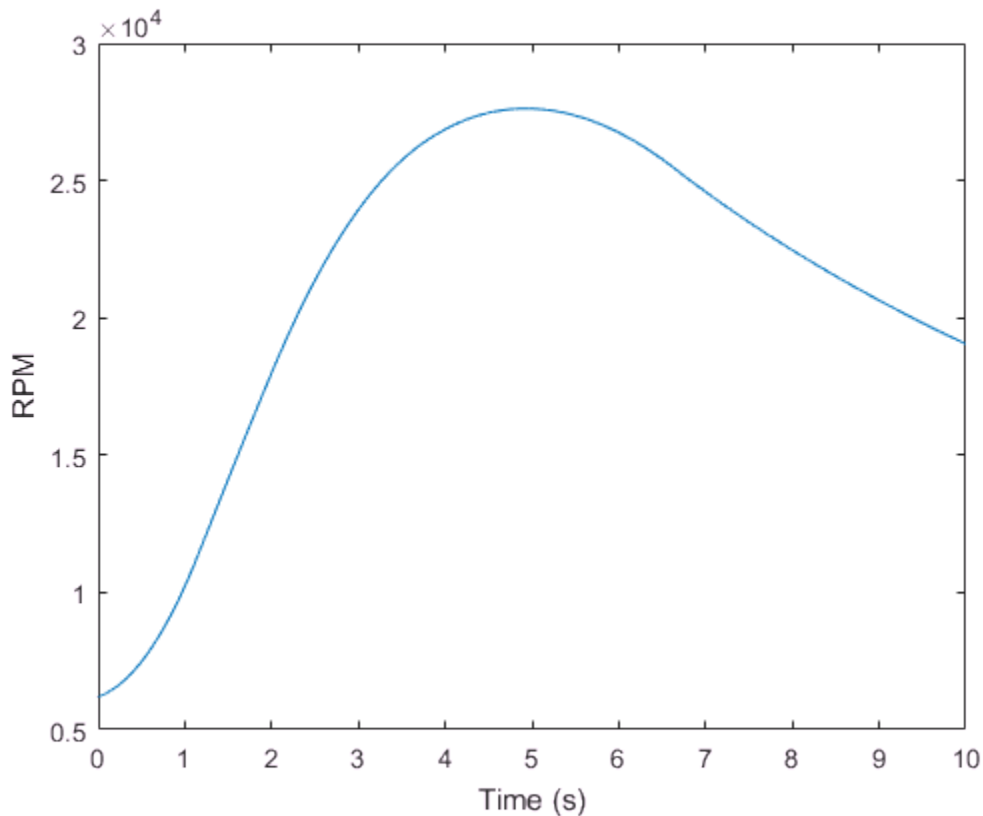

Compute the order-RPM map. Specify an order resolution of 0.015.

```
[map,order,rpmOut,time] = rpmordermap(vib,fs,rpm,0.015);
```

Visualize the map.

```
imagesc(time,order,map)
ax = gca;
ax.YDir = 'normal';
xlabel('Time (s)')
ylabel('Order')
```

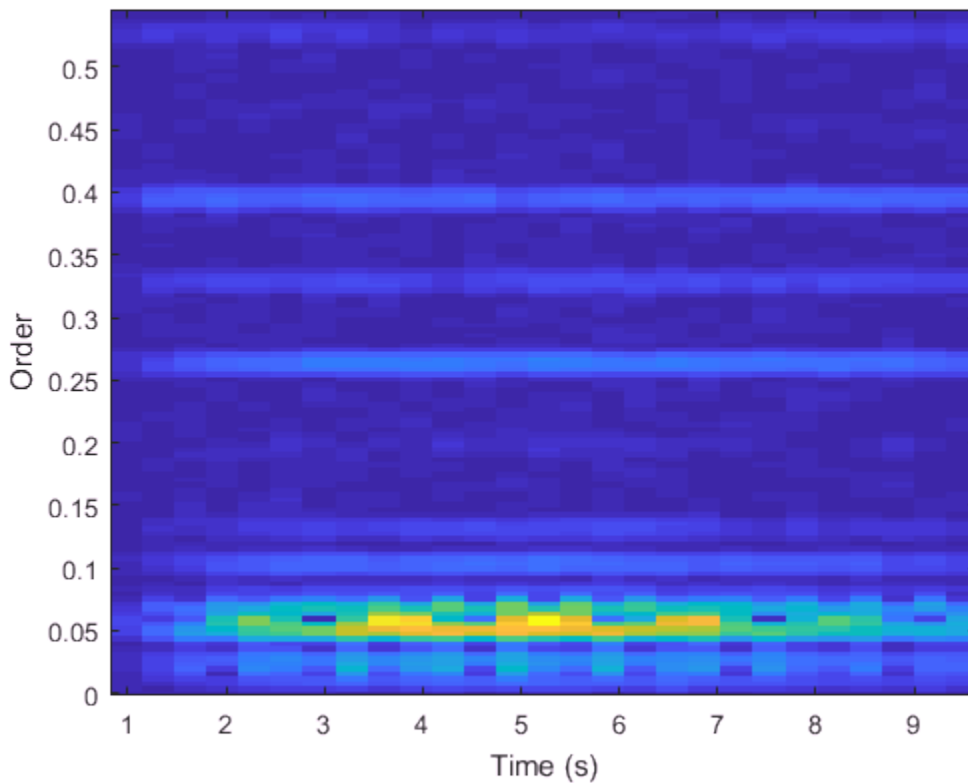

Repeat the computation using a finer order resolution. Plot the map using the built-in functionality of `rpmordermap`. The lower orders are resolved more clearly.

```
rpmordermap(vib,fs,rpm,0.005)
```

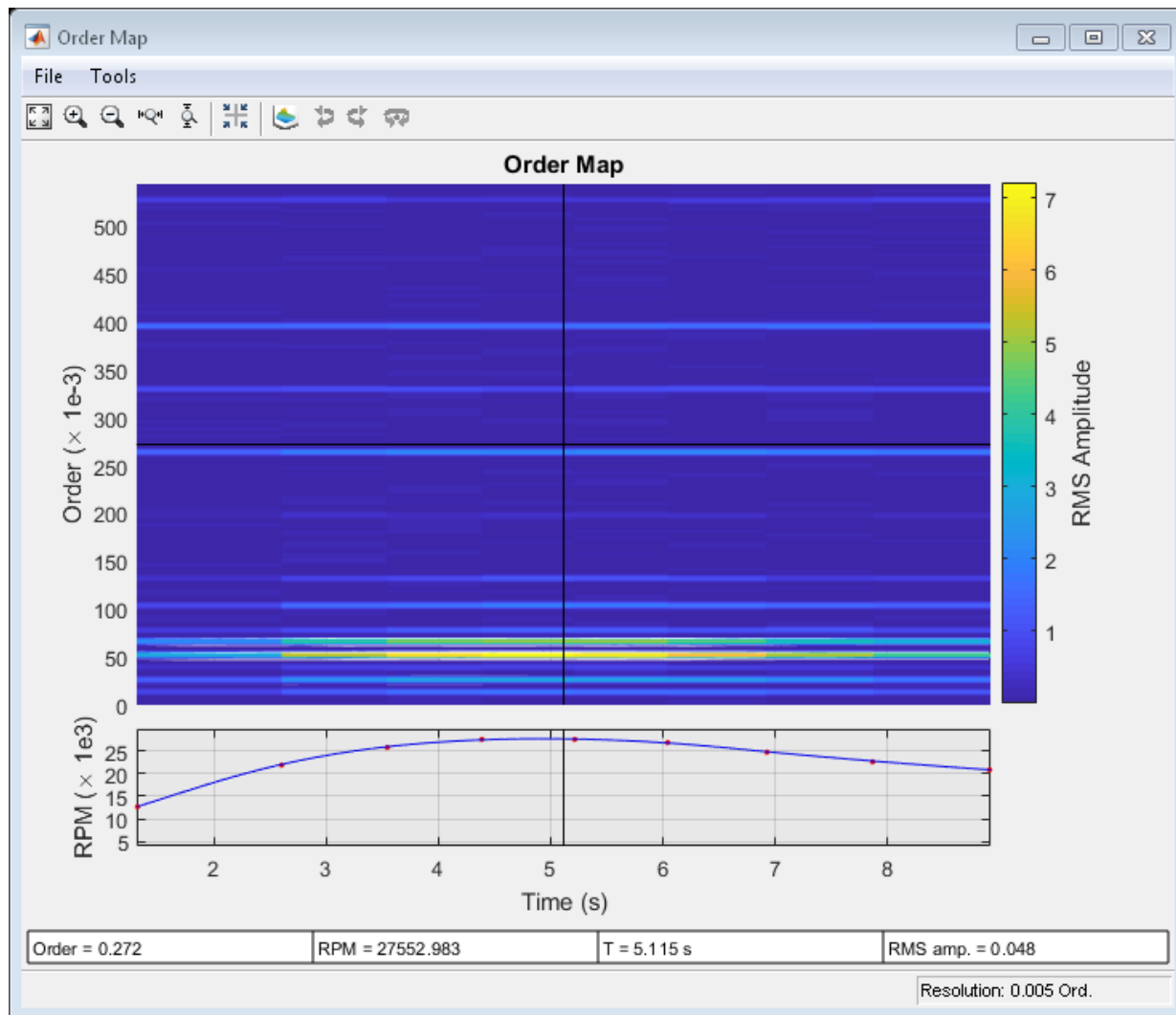

Waterfall Plot of Order-RPM Map

Generate a signal that consists of two linear chirps and a quadratic chirp, all sampled at 600 Hz for 5 seconds. The system that produces the signal increases its rotational speed from 10 to 40 revolutions per second during the testing period.

Generate the tachometer readings.

```
fs = 600;
t1 = 5;
t = 0:1/fs:t1;

f0 = 10;
f1 = 40;
rpm = 60*linspace(f0,f1,length(t));
```

The linear chirps have orders 1 and 2.5. The component with order 1 has twice the amplitude of the other. The quadratic chirp starts at order 6 and returns to this order at the end of the measurement. Its amplitude is 0.8. Create the signal using this information.

```
o1 = 1;
o2 = 2.5;
o6 = 6;

x = 2*chirp(t,o1*f0,t1,o1*f1)+chirp(t,o2*f0,t1,o2*f1) + ...
    0.8*chirp(t,o6*f0,t1,o6*f1, 'quadratic');
```

Compute the order-RPM map of the signal. Use the peak amplitude at each measurement cell. Specify a resolution of 0.25 orders. Window the data with a Chebyshev window whose sidelobe attenuation is 80 dB.

```
[map,or,rp] = rpmordermap(x,fs,rpm,0.25, ...
    'Amplitude','peak','Window',{ 'chebwin',80});
```

Draw the order-RPM map as a waterfall plot.

```
[OR,RP] = meshgrid(or,rp);
waterfall(OR,RP,map')

view(-15,45)
xlabel('Order')
ylabel('RPM')
```

```
zlabel('Amplitude')
```

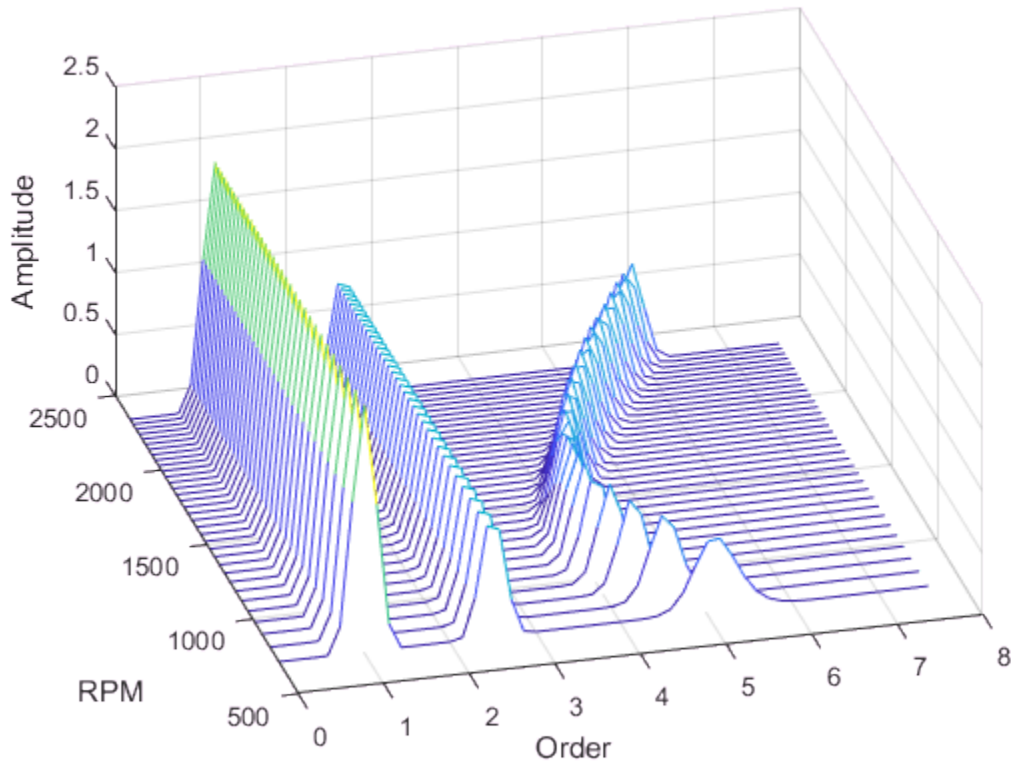

Interactive Order-RPM Map

Plot an interactive order-RPM map by calling `rpmordermap` without output arguments.

Load the file `helidata.mat`, which contains simulated vibrational data from an accelerometer placed in the cockpit of a helicopter. The data are sampled at a rate of 500 Hz for 10 seconds. Remove the linear trend in the data. Call `rpmordermap` to generate an interactive plot of the order-RPM map. Specify an order resolution of 0.005 orders.

```
load helidata.mat
rpmordermap(detrend(vib), fs, rpm, 0.005)
```

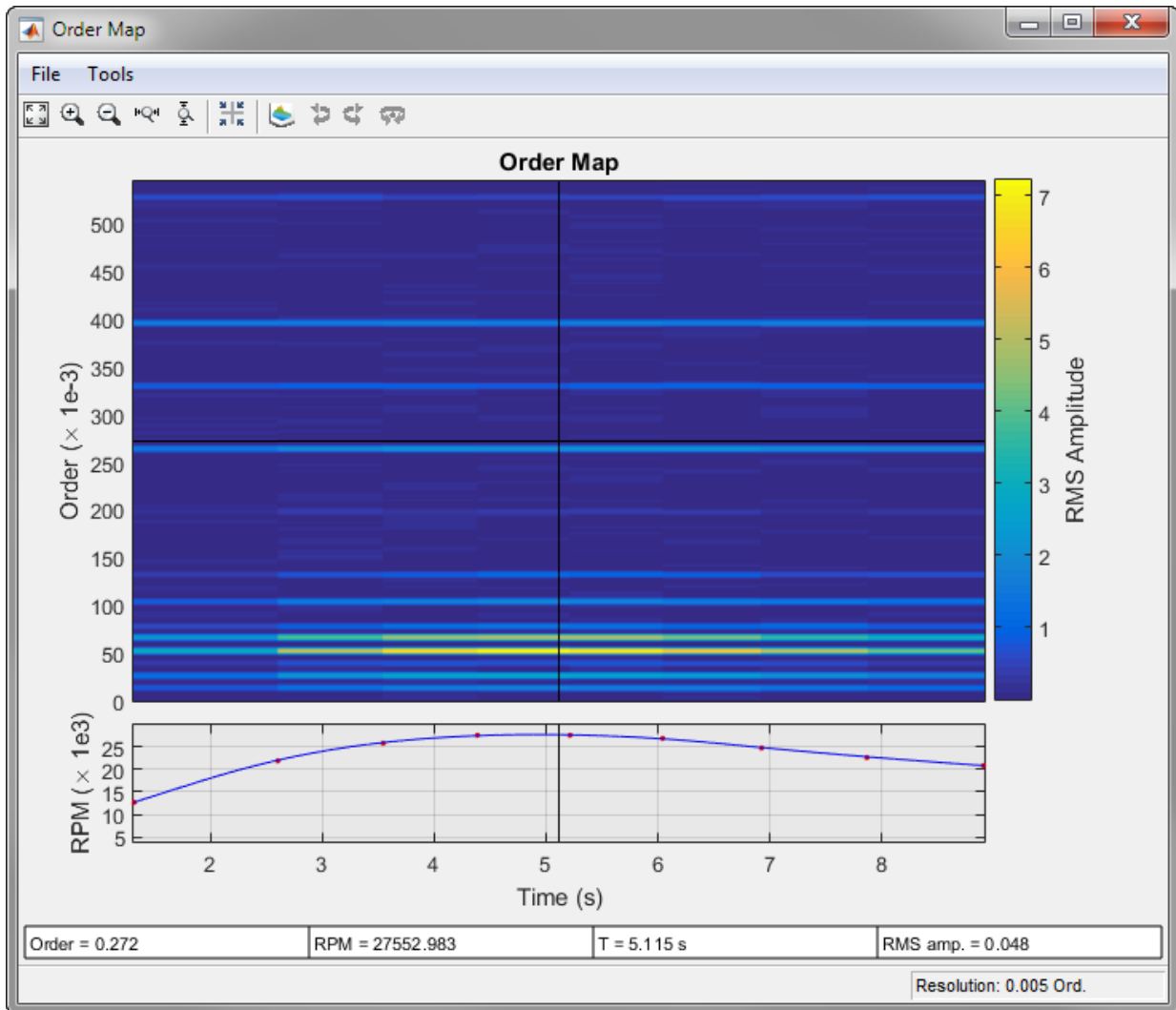

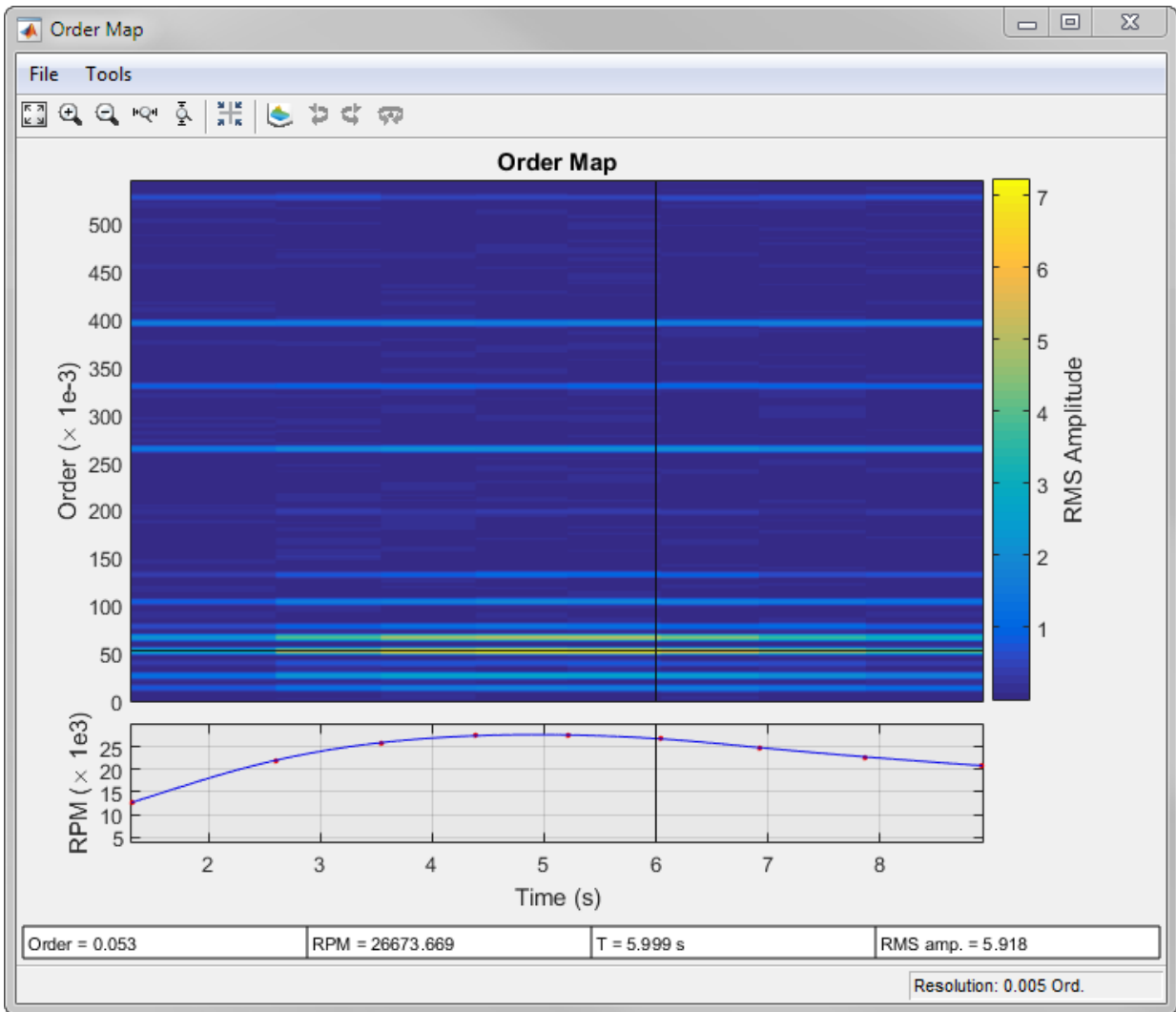

See “Algorithms” on page 1-1792 for a more detailed description of the RPM-vs.-time plot at the bottom of the figure.

Move the crosshair cursors in the figure to determine the RPM and the RMS amplitude at order 0.053 after 6 seconds.

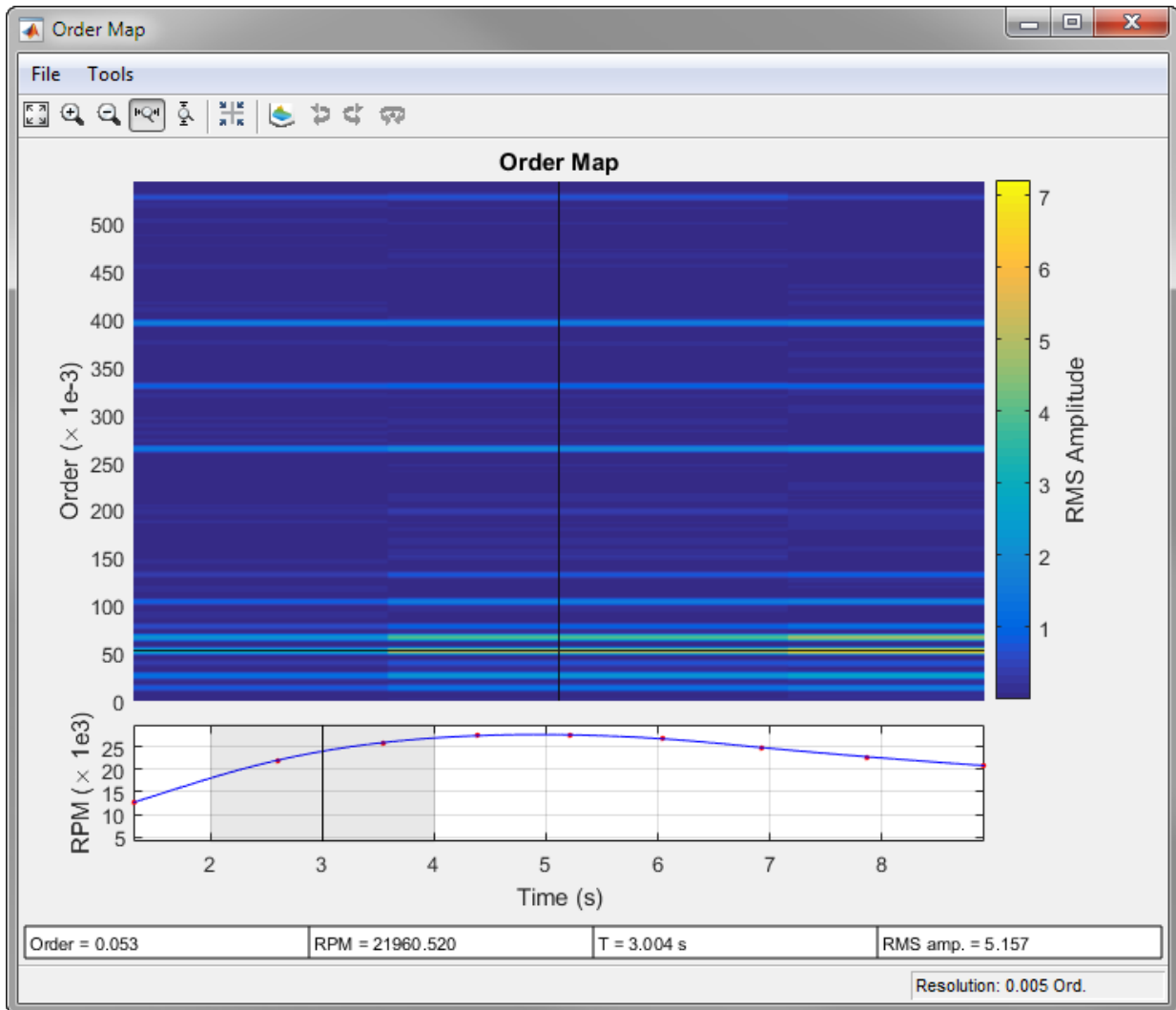

Click the **Zoom X** button  in the toolbar to zoom into the time region between 2 and 4 seconds. The gray rectangle in the RPM-vs.-time plot shows the region of interest. You can slide this region to pan through time.



Click the **Waterfall Plot** button  to display the order-RPM map as a waterfall plot.

For improved visibility, rotate the plot clockwise using the **Rotate Left** button  three times. Move the panner to the interval between 5 and 7 seconds.

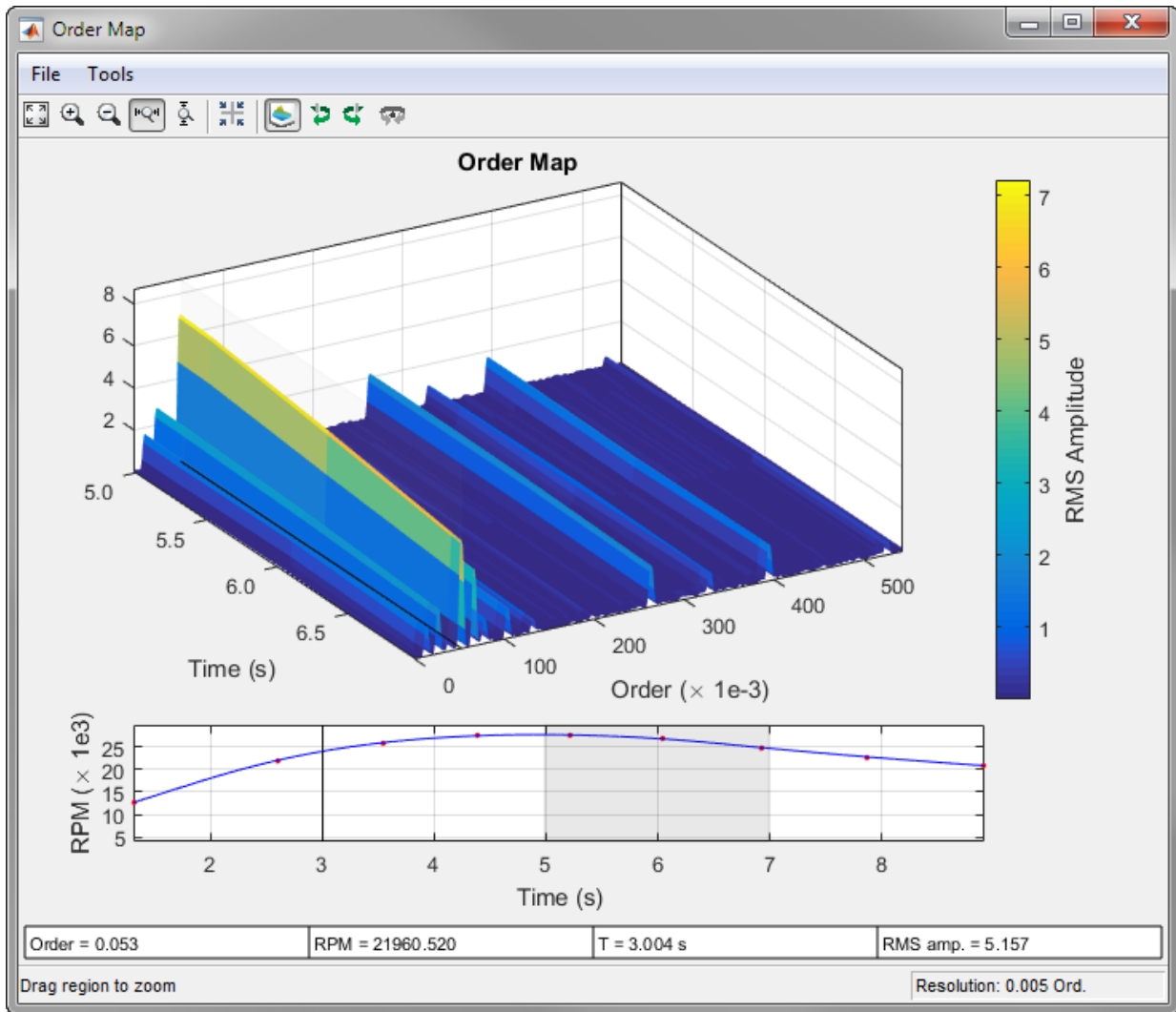

Input Arguments

x — Input signal
vector

Input signal, specified as a row or column vector.

Example: `cos(pi/4*(0:159))+randn(1,160)` specifies a sinusoid embedded in white Gaussian noise.

Data Types: `double` | `single`

fs — Sample rate

positive scalar

Sample rate, specified as a positive scalar expressed in Hz.

Data Types: `double` | `single`

rpm — Rotational speeds

vector of positive values

Rotational speeds, specified as a vector of positive values expressed in revolutions per minute. `rpm` must have the same length as `x`.

Example: `100:10:3000` specifies that a system rotates initially at 100 revolutions per minute and runs up to 3000 revolutions per minute in increments of 10.

Data Types: `double` | `single`

res — Order resolution

$(15 \times fs)/(16 \times \max(rpm))$ (default) | positive scalar

Order resolution of the order-RPM map, specified as a positive scalar. If `res` is not specified, then `rpmordermap` sets it to the sample rate of the constant-samples-per-cycle signal divided by 256. If the resampled input signal is not long enough, then the function uses the entire resampled signal length to compute a single order estimate.

Data Types: `single` | `double`

Name-Value Pair Arguments

Specify optional comma-separated pairs of `Name`, `Value` arguments. `Name` is the argument name and `Value` is the corresponding value. `Name` must appear inside single quotes (' '). You can specify several name and value pair arguments in any order as `Name1`, `Value1`, ..., `NameN`, `ValueN`.

Example: `'Scale','dB','Window','hann'` specifies that the order map estimates are to be scaled in decibels and determined using a Hann window.

'Amplitude' — Order-RPM map amplitudes`'rms' (default) | 'peak' | 'power'`

Order-RPM map amplitudes, specified as the comma-separated pair consisting of `'Amplitude'` and one of `'rms'`, `'peak'`, or `'power'`.

- `'rms'` — Returns the root-mean-square amplitude for each estimated order.
- `'peak'` — Returns the peak amplitude for each estimated order.
- `'power'` — Returns the power level for each estimated order.

Data Types: char

'OverlapPercent' — Overlap percentage between adjoining segments`50 (default) | scalar from 0 to 100`

Overlap percentage between adjoining segments, specified as the comma-separated pair consisting of `'OverlapPercent'` and a scalar from 0 to 100. A value of 0 means that adjoining segments do not overlap. A value of 100 means that adjoining segments are shifted by one sample. A larger overlap percentage produces a smoother map but increases the computation time. See “Algorithms” on page 1-1792 for more information.

Data Types: double | single

'Scale' — Order-RPM map scaling`'linear' (default) | 'dB'`

Order-RPM map scaling, specified as the comma-separated pair consisting of `'Scale'` and either `'linear'` or `'dB'`.

- `'linear'` — Returns a linearly scaled map.
- `'dB'` — Returns a logarithmic map with values expressed in decibels.

Data Types: char

'Window' — Analysis window`'flattopwin' (default) | 'chebwin' | 'hamming' | 'hann' | 'kaiser' | 'rectwin'`

Analysis window, specified as the comma-separated pair consisting of `'Window'` and one of these values:

- `'flattopwin'` specifies a flat top window. See `flattopwin` for more details.

- 'chebwin' specifies a Chebyshev window. Use a cell array to specify a sidelobe attenuation in decibels. The sidelobe attenuation must be greater than 45 dB. If not specified, it defaults to 100 dB. See `chebwin` for more details.
- 'hamming' specifies a Hamming window. See `hamming` for more details.
- 'hann' specifies a Hann window. See `hann` for more details.
- 'kaiser' specifies a Kaiser window. Use a cell array to specify a shape parameter, β . The shape parameter must be a positive scalar. If not specified, it defaults to 0.5. See `kaiser` for more details.
- 'rectwin' specifies a rectangular window. See `rectwin` for more details.

Example: 'Window', 'chebwin' specifies a Chebyshev window with a sidelobe attenuation of 100 dB.

Example: 'Window', {'chebwin', 60} specifies a Chebyshev window with a sidelobe attenuation of 60 dB.

Example: 'Window', 'kaiser' specifies a Kaiser window with a shape parameter of 0.5.

Example: 'Window', {'kaiser', 1} specifies a Kaiser window with a shape parameter of 1.

Data Types: char | cell

Output Arguments

map — Order-RPM map

matrix

Order-RPM map, returned as a matrix.

order — Orders

vector

Orders, returned as a vector.

rpm — Rotational speeds

vector

Rotational speeds, returned as a vector.

time — Time instants

vector

Time instants, returned as a vector.

res — Order resolution

scalar

Order resolution, returned as a scalar.

Algorithms

Order analysis is the study of vibrations in rotating systems that result from the rotation itself. The frequencies of these vibrations are often proportional to the rotational speed. The constants of proportionality are the *orders*.

The rotational speed is usually measured independently and changes with time under most experimental conditions. Proper analysis of rotation-induced vibrations requires resampling and interpolating the measured signal to achieve a constant number of samples per cycle. Through this process, the signal components whose frequencies are constant multiples of the rotational speed transform into constant tones. The transformation reduces the smearing of spectral components that occurs when frequency changes rapidly with time.

The `rpmordermap` function performs these steps:

- 1 Uses `cumtrapz` to estimate the phase angle as the time integral of the rotational speed:

$$\phi(t) = \int_0^t \frac{\text{RPM}(\tau)}{60} d\tau.$$

- 2 Uses `resample` to upsample and lowpass-filter the signal. This step enables the function to interpolate the signal at nonsampled time points without aliasing of the high-frequency components. `rpmordermap` upsamples the signal by a factor of 15.
- 3 Uses `interp1` to interpolate the upsampled signal linearly onto a uniform grid in the phase domain. The highest accessible order in a measurement is fixed by the sample rate and the highest rotational speed reached by the system:

$$O_{\max} = \frac{f_s/2}{\max\left(\frac{\text{RPM}}{60}\right)}.$$

To capture this highest order accurately, it is necessary to sample the signal at twice O_{\max} at least. For better results, `rpmordermap` oversamples by an extra factor of 4. The resulting phase-domain sample rate, f_p , is

$$f_p = 4 \times 2O_{\max} = 4 \times 2 \frac{f_s/2}{\max\left(\frac{\text{RPM}}{60}\right)}.$$

The default order resolution, r , is

$$r = \frac{f_p}{256} = \frac{4 \times 60}{256} \frac{2 \times f_s/2}{\max(\text{RPM})} = \frac{15}{16} \frac{f_s}{\max(\text{RPM})}.$$

- 4 Uses `spectrogram` to compute the short-time Fourier transform (STFT) of the interpolated signal. By default, the function divides the signal into L -sample segments and windows each of them with a flat top window. There are

$$N_{\text{overlap}} = \min\left(\left\lceil \frac{p_{\text{overlap}}}{100} \times L \right\rceil, L - 1\right)$$

samples of overlap between adjoining segments, where p_{overlap} is specified using the 'OverlapPercent' name-value pair and defaults to 50%. The DFT length is set to L . The resolution is related to the sample rate and segment length through

$$r = \frac{kf_p}{L},$$

where k is the equivalent noise bandwidth of the window, as implemented in `enbw`. Adjust the resolution to differentiate closely spaced orders. Smaller r values require larger segment lengths. If you need to attain a given resolution, make sure that your signal has enough samples.

The red dots in the RPM-vs.-time plot at the bottom of the interactive `rpmordermap` window correspond to the right edge of each windowed segment. The blue line in the plot is the RPM signal drawn as a function of time:

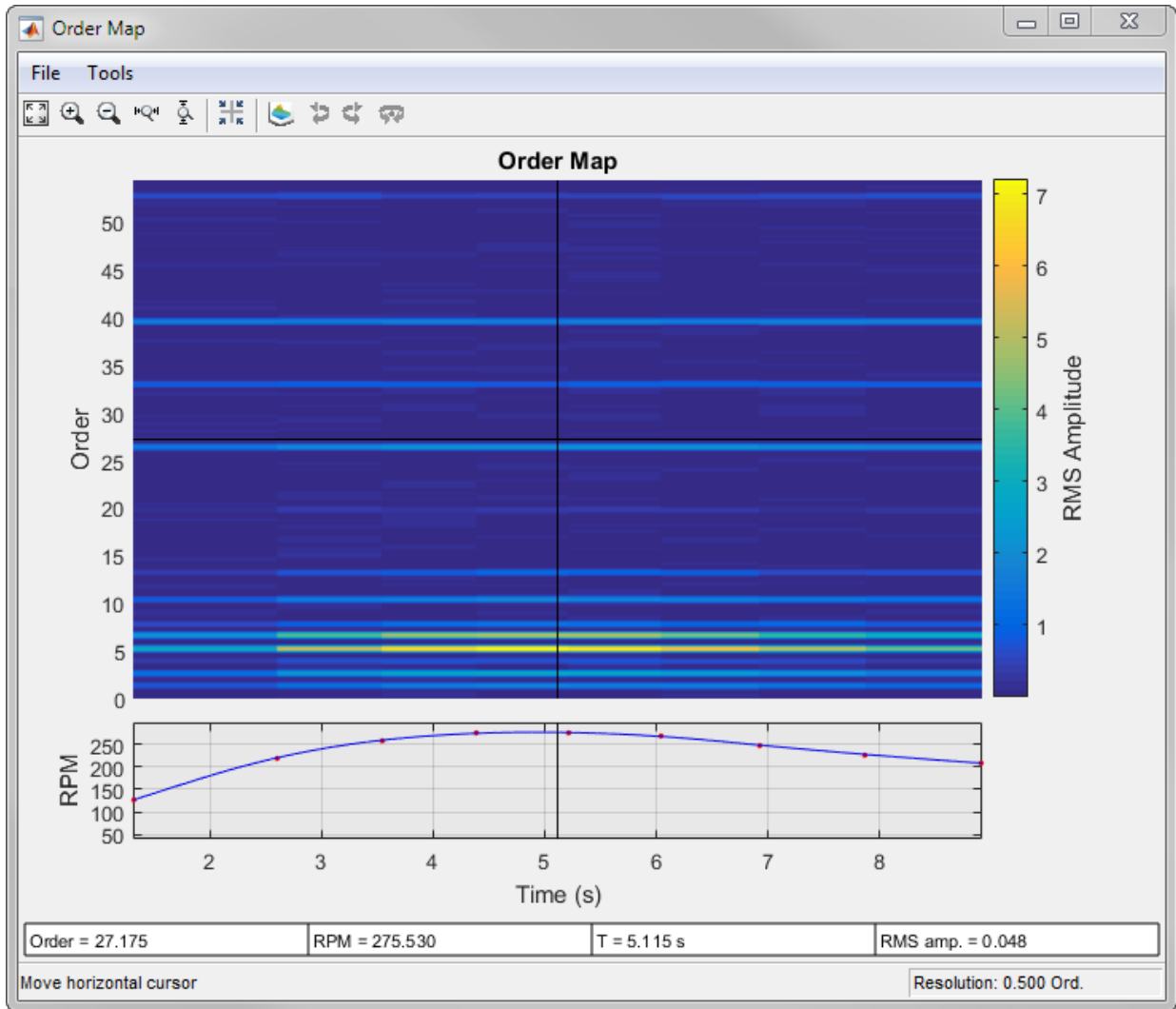

References

- [1] Brandt, Anders. *Noise and Vibration Analysis: Signal Analysis and Experimental Procedures*. Chichester, UK: John Wiley & Sons, 2011.

See Also

See Also

orderspectrum | ordertrack | orderwaveform | rpmfreqmap | spectrogram | tachorpm

Introduced in R2015b

rssq

Root-sum-of-squares level

Syntax

$Y = \text{rssq}(X)$

$Y = \text{rssq}(X, \text{DIM})$

Description

$Y = \text{rssq}(X)$ returns the root-sum-of-squares (RSS) level, Y , of the input, X . If X is a row or column vector, Y is a real-valued scalar. For matrices, Y contains the RSS levels computed along the first nonsingleton dimension. For example, if Y is an N -by- M matrix with $N > 1$, Y is a 1-by- M row vector containing the RSS levels of the columns of Y .

$Y = \text{rssq}(X, \text{DIM})$ computes the RSS level of X along the dimension, DIM .

Input Arguments

X

Real- or complex-valued input vector or matrix. By default, `rssq` acts along the first nonsingleton dimension of X .

DIM

Dimension for root-sum-of-squares (RSS) level. The optional `DIM` input argument specifies the dimension along which to compute the RSS level.

Default: First nonsingleton dimension

Output Arguments

Y

Root-sum-of-squares level. For vectors, Y is a real-valued scalar. For matrices, Y contains the RSS levels computed along the specified dimension, DIM. By default, DIM is the first nonsingleton dimension.

Examples

RSS Level of Sinusoid

Compute the RSS level of a 100 Hz sinusoid sampled at 1 kHz.

```
t = 0:0.001:1-0.001;
x = cos(2*pi*100*t);
```

```
y = rssq(x)
```

```
y = 22.3607
```

RSS Levels of 2-D Matrix

Create a matrix where each column is a 100 Hz sinusoid sampled at 1 kHz with a different amplitude. The amplitude is equal to the column index.

Compute the RSS levels of the columns.

```
t = 0:0.001:1-0.001;
x = cos(2*pi*100*t)'*(1:4);
```

```
y = rssq(x)
```

```
y =
```

```
22.3607    44.7214    67.0820    89.4427
```

RSS Levels of 2-D Matrix Along Specified Dimension

Create a matrix where each row is a 100 Hz sinusoid sampled at 1 kHz with a different amplitude. The amplitude is equal to the row index.

Compute the RSS levels of the rows specifying the dimension equal to 2 with the DIM argument.

```
t = 0:0.001:1-0.001;  
x = (1:4)' * cos(2*pi*100*t);
```

```
y = rssq(x,2)
```

```
y =
```

```
22.3607  
44.7214  
67.0820  
89.4427
```

Definitions

Root-Sum-of-Squares Level

The root-sum-of-squares (RSS) level of a vector, X , is

$$X_{\text{RSS}} = \sqrt{\sum_{n=1}^N |X_n|^2},$$

with the summation performed along the specified dimension. The RSS is also referred to as the ℓ^2 norm.

References

- [1] *IEEE Standard on Transitions, Pulses, and Related Waveforms*, IEEE Standard 181, 2003.

See Also

See Also

mean | peak2peak | peak2rms | rms | std

Introduced in R2012a

sawtooth

Sawtooth or triangle wave

Syntax

```
sawtooth(t)  
sawtooth(t,width)
```

Description

`sawtooth(t)` generates a sawtooth wave with period 2π for the elements of time vector `t`. `sawtooth(t)` is similar to `sin(t)`, but creates a sawtooth wave with peaks of -1 and 1 instead of a sine wave. The sawtooth wave is defined to be -1 at multiples of 2π and to increase linearly with time with a slope of $1/\pi$ at all other times.

`sawtooth(t,width)` generates a modified triangle wave where `width`, a scalar parameter between 0 and 1 , determines the point between 0 and 2π at which the maximum occurs. The function increases from -1 to 1 on the interval 0 to $2\pi \times \text{width}$, then decreases linearly from 1 to -1 on the interval $2\pi \times \text{width}$ to 2π . Thus a parameter of 0.5 specifies a standard triangle wave, symmetric about time instant π with peak-to-peak amplitude of 1 . `sawtooth(t,1)` is equivalent to `sawtooth(t)`.

Examples

50 Hz Sawtooth Waveform

Generate 10 periods of a sawtooth wave with a fundamental frequency of 50 Hz. The sample rate is 1 kHz.

```
T = 10*(1/50);  
Fs = 1000;  
dt = 1/Fs;  
t = 0:dt:T-dt;  
x = sawtooth(2*pi*50*t);
```

```
plot(t,x)  
grid on
```

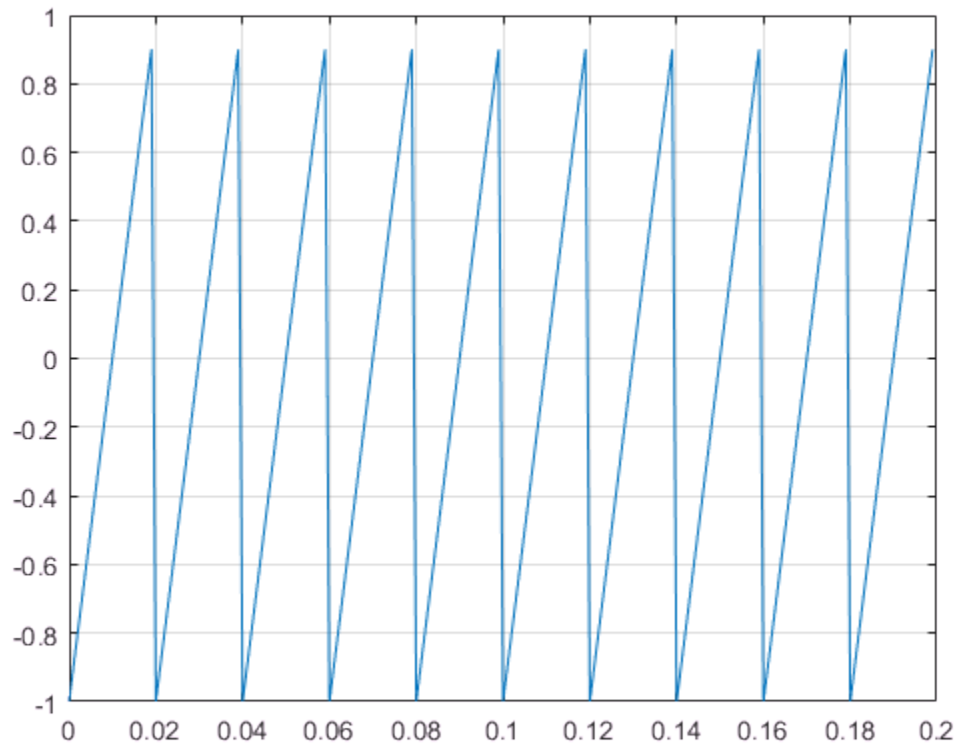

Plot the power spectrum.

```
periodogram(x,[],length(x),Fs,'power')
```

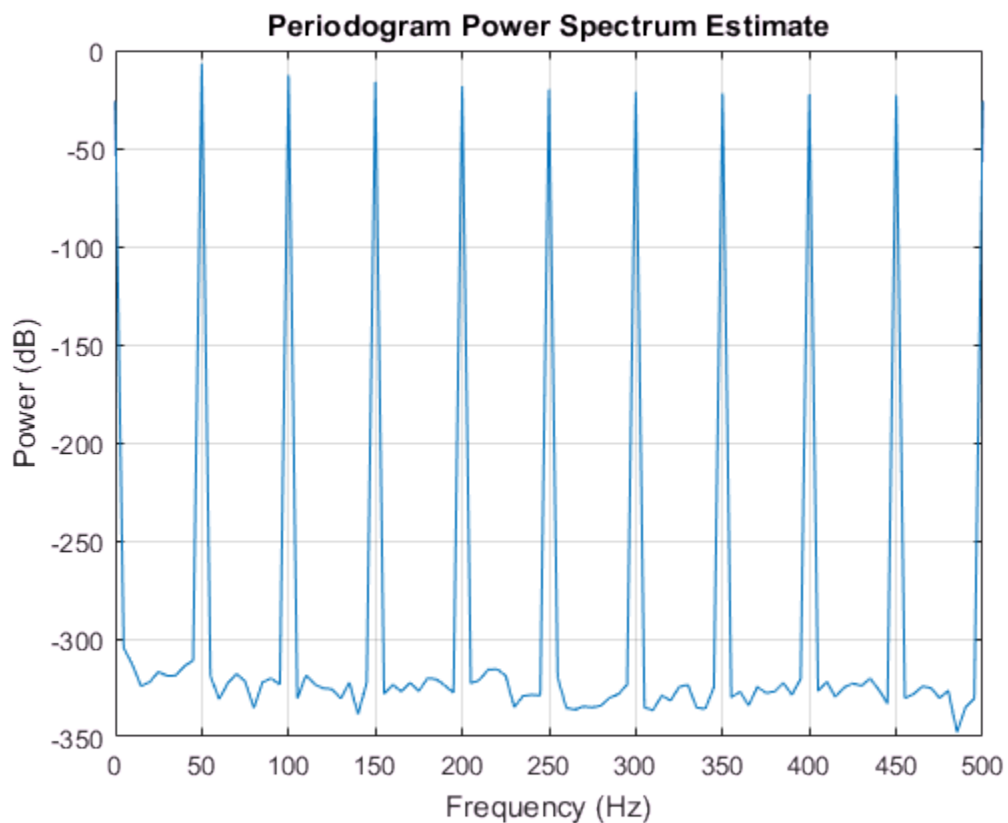

See Also

chirp | cos | diric | gauspuls | pulstran | rectpuls | sin | sinc | square | tripuls

Introduced before R2006a

schurrc

Compute reflection coefficients from autocorrelation sequence

Syntax

```
k = schurrc(r)
[k,e] = schurrc(r)
```

Description

`k = schurrc(r)` uses the Schur algorithm to compute a vector `k` of reflection coefficients from a vector `r` representing an autocorrelation sequence. `k` and `r` are the same size. The reflection coefficients represent the lattice parameters of a prediction filter for a signal with the given autocorrelation sequence, `r`. When `r` is a matrix, `schurrc` treats each column of `r` as an independent autocorrelation sequence, and produces a matrix `k`, the same size as `r`. Each column of `k` represents the reflection coefficients for the lattice filter for predicting the process with the corresponding autocorrelation sequence `r`.

`[k,e] = schurrc(r)` also computes the scalar `e`, the prediction error variance. When `r` is a matrix, `e` is a column vector. The number of rows of `e` is the same as the number of columns of `r`.

Examples

Reflection Coefficients of Speech Autocorrelation Sequence

Create an autocorrelation sequence from the MATLAB® speech signal contained in `mtlb.mat`. Use the Schur algorithm to compute the reflection coefficients of a lattice prediction filter for the sequence.

```
load mtlb
r = xcorr(mtlb(1:5), 'unbiased');
k = schurrc(r(5:end))
```

```
k =
```

-0.7583
0.1384
0.7042
-0.3699

References

- [1] Proakis, John G., and Dimitris G. Manolakis. *Digital Signal Processing: Principles, Algorithms, and Applications*. 3rd Edition. Upper Saddle River, NJ: Prentice-Hall, 1996, pp.868–873.

See Also

levinson

Introduced before R2006a

settlingtime

Settling time for bilevel waveform

Syntax

```
S = settlingtime(X,D)
S = settlingtime(X,FS,D)
S = settlingtime(X,T,D)
[S,SLEV,SINST] = settlingtime(...)
[S,SLEV,SINST] = settlingtime(...,Name,Value)
settlingtime(...)
```

Description

`S = settlingtime(X,D)` returns the time, **S**, from the mid-reference level instant to the time instant each transition enters and remains within a 2% tolerance region of the final state over the duration, **D**. **D** is a positive scalar. Because `settlingtime` uses interpolation to determine the mid-reference level instant, **S** may contain values that do not correspond to sampling instants. The length of **S** is equal to the number of detected transitions in the input signal, **X**. If for any transition, the level of the waveform does not remain within the lower and upper tolerance boundaries, the requested duration is not present, or an intervening transition is detected, `settlingtime` marks the corresponding element in **S** as NaN. See “Settle Seek Duration” on page 1-1812 for cases in which `settlingtime` returns a NaN. To determine the transitions, `settlingtime` estimates the state levels of the input waveform by a histogram method. `settlingtime` identifies all regions that cross the upper-state boundary of the low state and the lower-state boundary of the high state. The low-state and high-state boundaries are expressed as the state level plus or minus a multiple of the difference between the state levels. See “State-Level Tolerances” on page 1-1811.

`S = settlingtime(X,FS,D)` specifies the sampling rate for the bilevel waveform, **X** in hertz. The first sample instant in **X** is equal to $t = 0$. Because `settlingtime` uses interpolation to determine the mid-reference level instant, **S** may contain values that do not correspond to sampling instants.

`S = settlingtime(X,T,D)` specifies the sample instants, **T**, as a vector with the same number of elements as **X**.

`[S,SLEV,SINST] = settlingtime(...)` returns vectors, `SLEV`, and `SINST`, whose elements correspond to the levels and sample instants of the settling points for each transition.

`[S,SLEV,SINST] = settlingtime(...,Name,Value)` returns the settling times, levels, and corresponding sample instants with additional options specified by one or more `Name,Value` pair arguments.

`settlingtime(...)` plots the signal and darkens the regions of each transition where settling time is computed. The plot marks the location of the settling time of each transition, the mid-crossings, and the associated reference levels. The plot also displays the state levels with the corresponding lower and upper tolerance boundaries.

Input Arguments

X

Bilevel waveform. `X` is a real-valued row or column vector.

D

Settle-seek duration. `D` is a positive scalar, which defines the duration after the mid-reference level instant that `settlingtime` looks for a settling time. If no settling time occurs in `D` seconds after the mid-reference level instant, `settlingtime` returns a NaN. See “Settling Time” on page 1-1810 and “Settle Seek Duration” on page 1-1812.

FS

Sample rate in hertz.

T

Vector of sample instants. The length of `T` must equal the length of the bilevel waveform, `X`.

Name-Value Pair Arguments

'MidPercentReferenceLevel'

Mid-reference level as a percentage of the waveform amplitude. See “Mid-Reference Level” on page 1-1810.

Default: 50

'StateLevels'

Low and high-state levels. `StateLevels` is a 1-by-2 real-valued vector. The first element is the low-state level. The second element is the high-state level. If you do not specify low and high-state levels, `settlingtime` estimates the state levels from the input waveform using the histogram method.

'Tolerance'

Tolerance levels (lower and upper state boundaries) expressed as a percentage. See “State-Level Tolerances” on page 1-1811.

Default: 2

Output Arguments

s

The time from the mid-reference level instant to the time instant each transition enters and remains within a 2% tolerance region of the final state over duration, `D`.

SLEV

Waveform values at the settling points.

SINST

Time instants of the settling points.

Examples

Determine Settling Point and Settling Level

Determine the settling point and corresponding waveform value for a bilevel waveform. Specify a settle-peek duration of 10 seconds.

```
load('transitionex.mat', 'x')  
[s,slev,sinst] = settlingtime(x,10);
```

Plot the waveform and annotate the settling point.

```
settlingtime(x,10)
```

```
ans = 1.8901
```

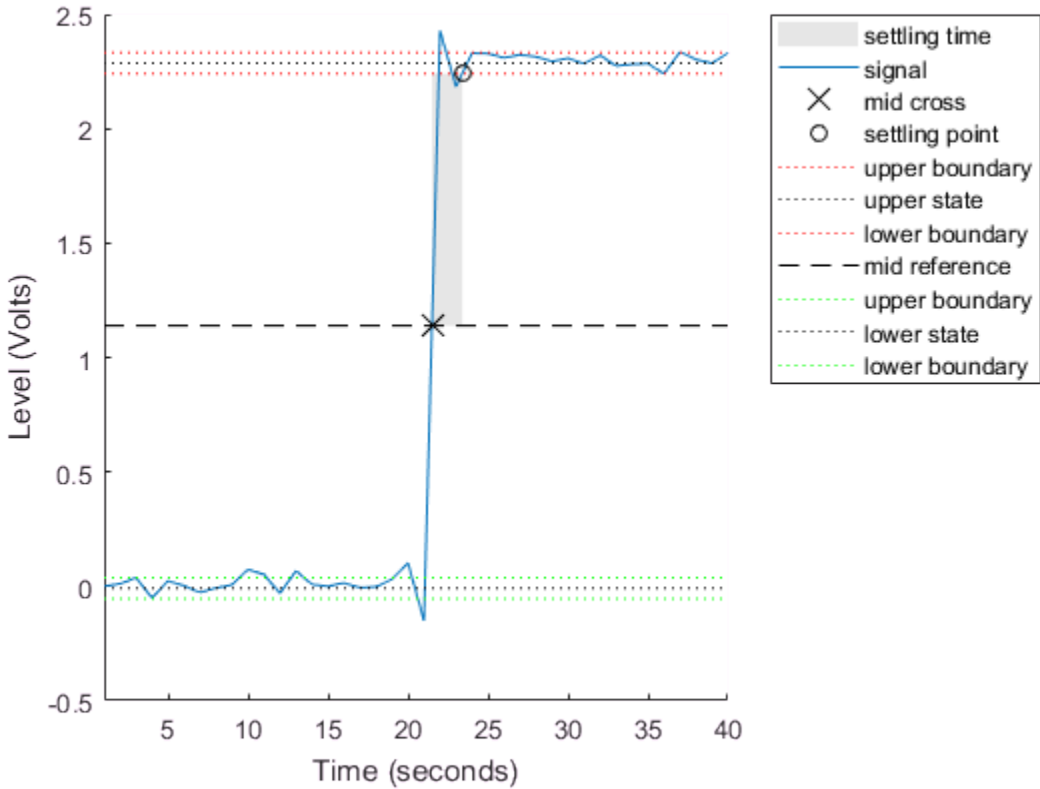

Determine Settling Points of Three-Transition Bilevel Waveform

Determine the settling points for a three-transition bilevel waveform. The data are sampled at 4 MHz. Specify a settle-seek duration of one microsecond.

```
load('transitionx.mat','x')
y = [x; flip1r(x)];
fs = 4e6;
t = 0:1/fs:(length(y)*1/fs)-1/fs;
```

```
[s,slev,sinst] = settlingtime(y,fs,1e-6);
```

Plot the waveform and annotate the settling points.

```
settlingtime(y,fs,1e-6)
```

```
ans =
```

```
1.0e-06 *
```

```
0.4725
```

```
0.1181
```

```
0.4725
```

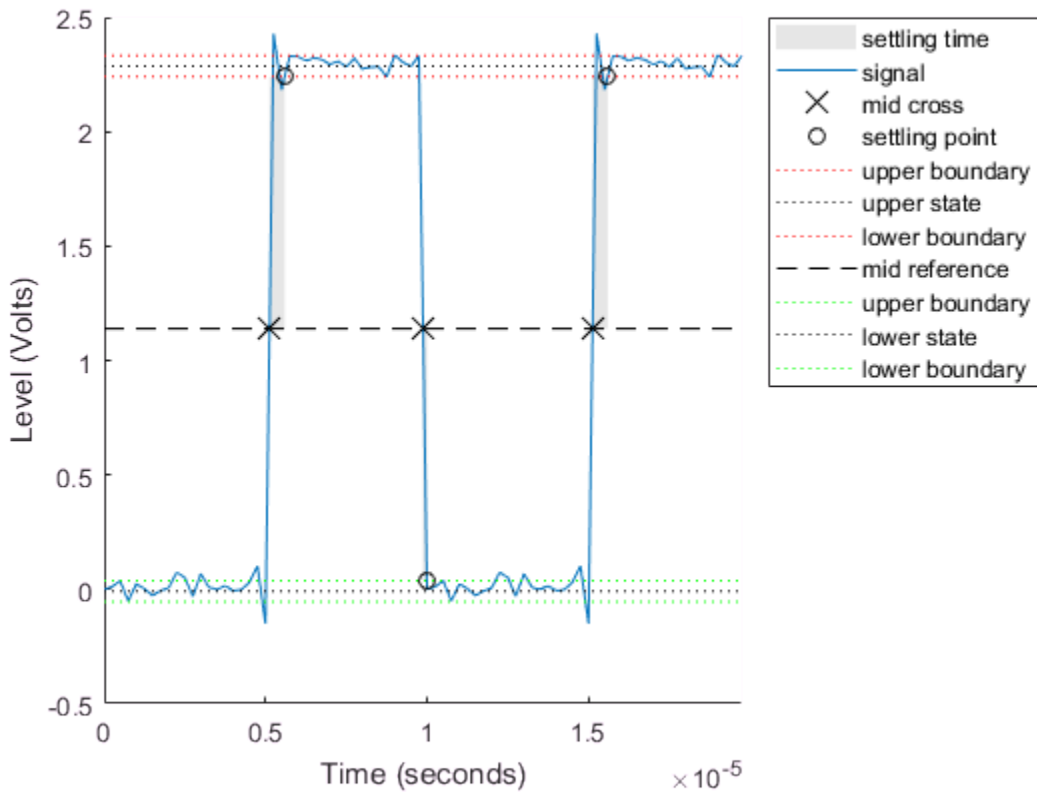

Definitions

Settling Time

The settling time is the time after the mid-reference level instant when the signal crosses into and remains in the 2%-tolerance region around the state level. The settling time is illustrated in the following figure. The low- and high-state levels are the dashed black lines. The 2% tolerances above and below the state levels are shown by the red dashed lines and the settling time is indicated by the yellow circle.

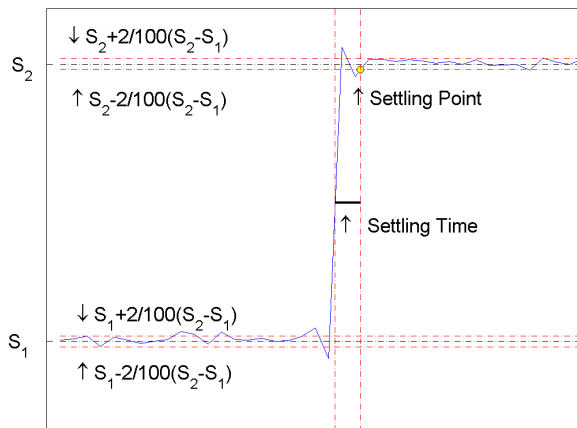

Mid-Reference Level

The mid-reference level in a bilevel waveform with low-state level, S_1 , and high- state level, S_2 , is

$$S_1 + \frac{1}{2}(S_2 - S_1)$$

Mid-Reference Level Instant

Let $y_{50\%}$ denote the mid reference level.

Let $t_{50\%_-}$ and $t_{50\%_+}$ denote the two consecutive sampling instants corresponding to the waveform values nearest in value to $y_{50\%}$.

Let $y_{50\%_-}$ and $y_{50\%_+}$ denote the waveform values at $t_{50\%_-}$ and $t_{50\%_+}$.

The mid-reference level instant is

$$t_{50\%} = t_{50\%_-} + \left(\frac{t_{50\%_+} - t_{50\%_-}}{y_{50\%_+} - y_{50\%_-}} \right) (y_{50\%} - y_{50\%_-})$$

State-Level Tolerances

Each state level can have associated lower- and upper-state boundaries. These state boundaries are defined as the state level plus or minus a scalar multiple of the difference between the high state and the low state. To provide a useful tolerance region, the scalar is typically a small number such as 2/100 or 3/100. In general, the $\alpha\%$ region for the low state is defined as

$$S_1 \pm \frac{\alpha}{100} (S_2 - S_1),$$

where S_1 is the low-state level and S_2 is the high-state level. Replace the first term in the equation with S_2 to obtain the $\alpha\%$ tolerance region for the high state.

The following figure illustrates lower and upper 2% state boundaries (tolerance regions) for a positive-polarity bilevel waveform. The red dashed lines indicate the estimated state levels.

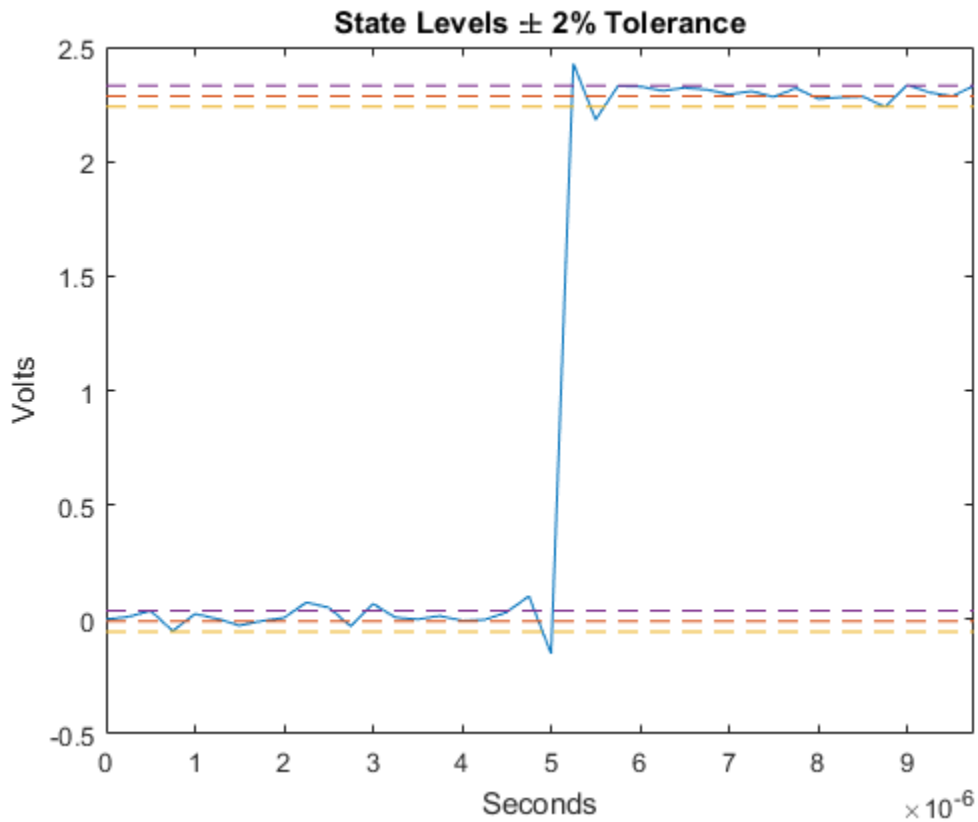

Settle Seek Duration

The settle seek duration defines the interval of time after the mid-reference level instant that `settlingtime` looks for a settling point. If `settlingtime` does not find a settling point within the settle seek duration, `settlingtime` returns NaN for the settling time. The following figure illustrates a settle seek duration of 10 samples.

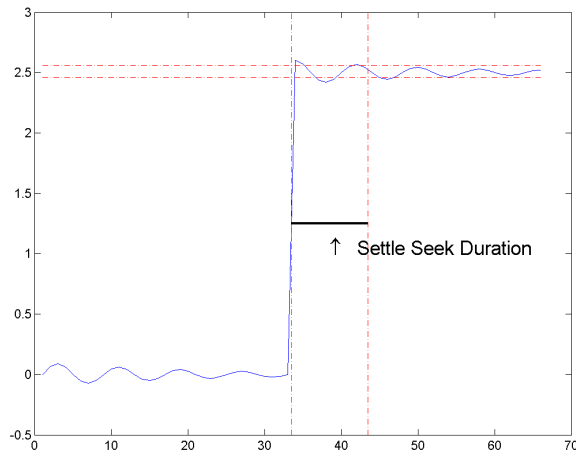

`settlingtime` may fail to find a settling point in the specified settle seek duration if any one of the following conditions occurs:

- The last waveform value in the settle seek interval is not within the upper- and lower-state boundaries determined by the specified tolerance. The following figure illustrates this condition for a settle seek duration of 8 samples and a 2% tolerance region.

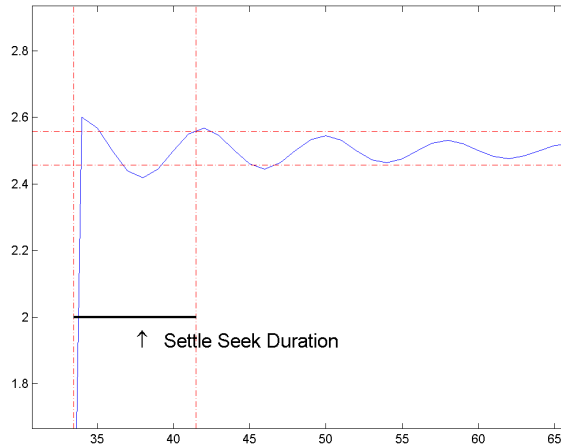

In the preceding figure, you see that the last sample in the settle seek interval exceeds the upper state boundary. In this example, reducing or increasing the settle seek duration can result in a valid settling time.

- There is an insufficient number of waveform samples for the specified settle seek duration. The following figure illustrates this condition for a settle seek duration of 20 samples. The settle seek duration extends beyond the final sample of the waveform.

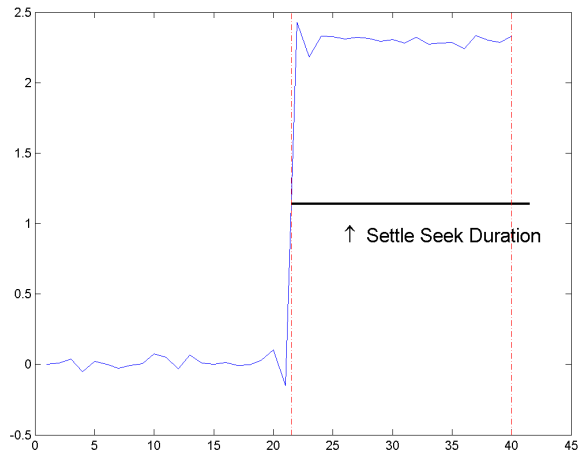

- An intervening transition is detected before the end of the specified settle seek duration. The following figure illustrates this condition for a settle seek duration of 22 samples. An intervening transition is detected before the end of the 22-sample settle seek duration.

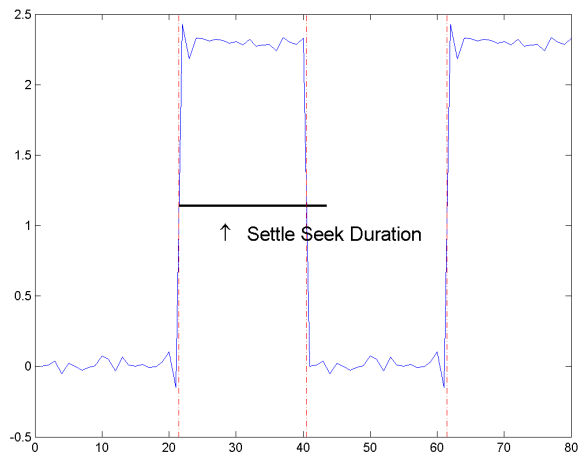

References

- [1] *IEEE Standard on Transitions, Pulses, and Related Waveforms*, IEEE Standard 181, 2003, pp. 23–24.

See Also

See Also

`falltime` | `midcross` | `pulsewidth` | `risetime` | `statelevels`

Introduced in R2012a

seqperiod

Compute period of sequence

Syntax

```
p = seqperiod(x)
[p,num] = seqperiod(x)
```

Description

`p = seqperiod(x)` returns the integer `p` that corresponds to the period of the sequence in a vector `x`. The period `p` is computed as the minimum length of a subsequence `x(1:p)` of `x` that repeats itself continuously every `p` samples in `x`. The length of `x` does not have to be a multiple of `p`, so that an incomplete repetition is permitted at the end of `x`. If the sequence `x` is not periodic, then `p = length(x)`.

- If `x` is a matrix, then `seqperiod` checks for periodicity along each column of `x`. The resulting output `p` is a row vector with the same number of columns as `x`.
- If `x` is a multidimensional array, then `seqperiod` checks for periodicity along the first nonsingleton dimension of `x`. In this case:
 - `p` is a multidimensional array of integers with a leading singleton dimension.
 - The lengths of the remaining dimensions of `p` correspond to those of the dimensions of `x` after the first nonsingleton one.

`[p,num] = seqperiod(x)` also returns the number `num` of repetitions of `x(1:p)` in `x`. `num` might not be an integer.

Examples

Multichannel Signal Periods

Generate a multichannel signal and determine the period of each column.

```
x = [4 0 1 6;
```

```
2 0 2 7;  
4 0 1 5;  
2 0 5 6];
```

```
p = seqperiod(x)
```

```
p =
```

```
2     1     4     3
```

The first column of x has period 2. The second column of x has period 1. The third column of x is not periodic, so $p(3)$ is just the number of rows of x . The fourth column of x has period 3, although the second repetition of the periodic sequence is incomplete.

Introduced before R2006a

setspecs

Specifications for filter specification object

Syntax

```
setspecs(D,specvalue1,specvalue2,...)
setspecs(D,Specification,specvalue1,specvalue2,...)
setspecs(...Fs)
setspecs(...,MAGUNITS)
```

Description

`setspecs(D,specvalue1,specvalue2,...)` sets the specifications in filter specification object, `D`, in the same order they appear in the `Specification` property.

`setspecs(D,Specification,specvalue1,specvalue2,...)` changes the specifications for an existing filter specification object and sets values for the new `Specification` property.

`setspecs(...Fs)` specifies the sampling frequency, `Fs`, in Hz. The sampling frequency must be a scalar trailing all other specifications. Entering a sampling frequency causes all other frequency specifications to be in Hz.

`setspecs(...,MAGUNITS)` specifies the units for any magnitude specifications. `MAGUNITS` can be one of the following: 'linear', 'dB', or 'squared'. The default is 'dB'. The magnitude specifications are always converted and stored in dB regardless of how the units are specified.

Use `SET(D,'SPECIFICATION')` to get the list of all available specification types for the filter specification object, `D`.

Examples

Set the Filter Order and Cutoff Frequency Using `setspecs`

Construct a lowpass filter with specifications for the filter order and cutoff frequency (-6 dB). Use `setspecs` after construction to set the values of the filter order and cutoff frequency. Display the values in the MATLAB® command window.

```
D = fdesign.lowpass('N,Fc');  
setspecs(D,10,0.2);
```

```
D.FilterOrder
```

```
ans =
```

```
    10
```

```
D.Fcutoff
```

```
ans =
```

```
    0.2000
```

See Also

[design](#) | [designmethods](#) | [fdesign](#) | [designopts](#)

Introduced in R2011b

sfdr

Spurious free dynamic range

Syntax

```

r = sfdr(x)
r = sfdr(x, fs)
r = sfdr(x, fs, msd)

r = sfdr(sxx, f, 'power')
r = sfdr(sxx, f, msd, 'power')

[r, spurpow, spurfreq] = sfdr( ___ )

sfdr( ___ )

```

Description

`r = sfdr(x)` returns the spurious free dynamic range (SFDR), r , in dB of the real sinusoidal signal, x . `sfdr` computes the power spectrum using a modified periodogram and a Kaiser window with $\beta = 38$. The mean is subtracted from x before computing the power spectrum. The number of points used in the computation of the discrete Fourier transform (DFT) is the same as the length of the signal, x .

`r = sfdr(x, fs)` returns the SFDR of the time-domain input signal, x , when the sample rate, fs , is specified. The default value of fs is 1 Hz.

`r = sfdr(x, fs, msd)` returns the SFDR considering only spurs that are separated from the fundamental (carrier) frequency by the minimum spur distance, msd , specified in cycles/unit time. The sample rate is fs . If the carrier frequency is Fc , then all spurs in the interval $(Fc - msd, Fc + msd)$ are ignored.

`r = sfdr(sxx, f, 'power')` returns the SFDR of the one-sided power spectrum of a real-valued signal, sxx . f is the vector of frequencies corresponding to the power estimates in sxx . The first element of f must equal 0. The algorithm removes all the power that decreases monotonically away from the DC bin.

`r = sfdr(sxx, f, msd, 'power')` returns the SFDR considering only spurs that are separated from the fundamental (carrier) frequency by the minimum spur distance, `msd`. If the carrier frequency is `Fc`, then all spurs in the interval $(F_c - \text{msd}, F_c + \text{msd})$ are ignored. When the input to `sfdr` is a power spectrum, specifying `msd` can prevent high sidelobe levels from being identified as spurs.

`[r, spurpow, spurfreq] = sfdr(___)` returns the power and frequency of the largest spur.

`sfdr(___)` with no output arguments plots the spectrum of the signal in the current figure window. It uses different colors to draw the fundamental component, the DC value, and the rest of the spectrum. It shades the SFDR and displays its value above the plot. It also labels the fundamental and the largest spur.

Examples

SFDR of Sinusoid

Obtain the SFDR for a 10 MHz tone with amplitude 1 sampled at 100 MHz. There is a spur at the 1st harmonic (20 MHz) with an amplitude of 3.16×10^{-4} .

```
deltat = 1e-8;  
fs = 1/deltat;  
t = 0:deltat:1e-5-deltat;  
x = cos(2*pi*10e6*t)+3.16e-4*cos(2*pi*20e6*t);  
r = sfdr(x,fs)
```

```
r = 70.0063
```

Display the spectrum of the signal. Annotate the fundamental, the DC value, the spur, and the SFDR.

```
sfdr(x,fs);
```

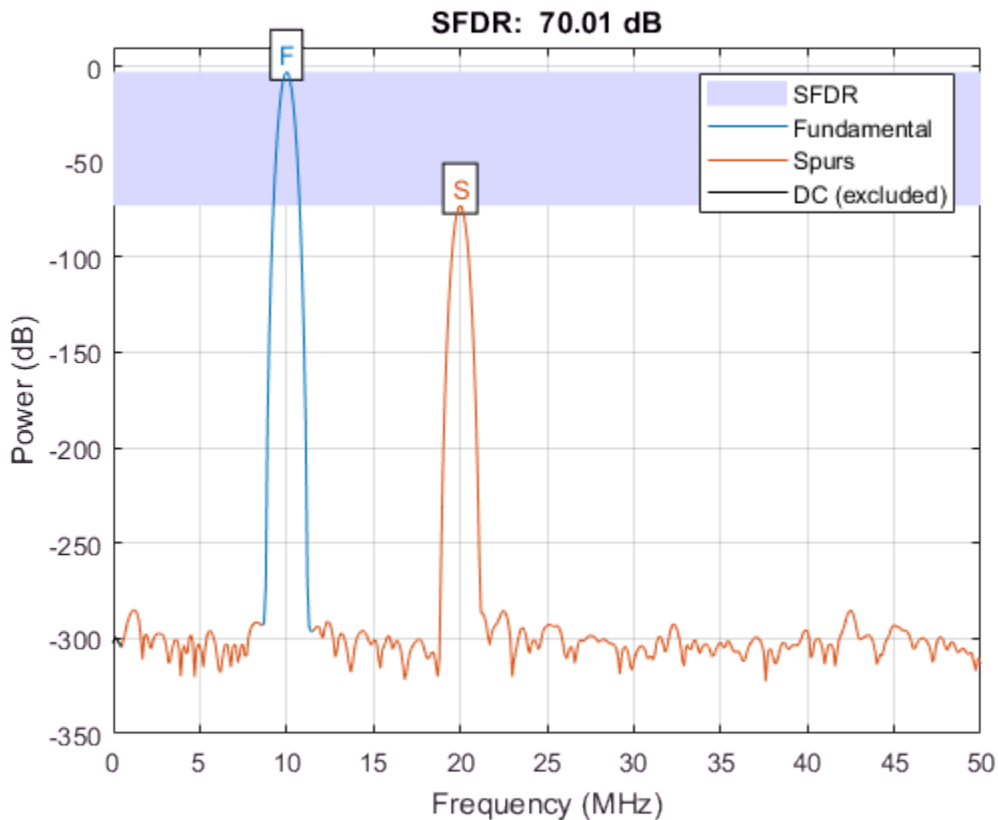

Minimum Spur Distance

Obtain the SFDR for a 10 MHz tone with amplitude 1 sampled at 100 MHz. There is a spur at the 1st harmonic (20 MHz) with an amplitude of 3.16×10^{-4} and another spur at 25 MHz with an amplitude of 10^{-5} . Skip the first harmonic by using a minimum spur distance of 11 MHz.

```
deltat = 1e-8;
fs = 1/deltat;
t = 0:deltat:1e-5-deltat;
x = cos(2*pi*10e6*t)+3.16e-4*cos(2*pi*20e6*t)+ ...
    0.1e-5*cos(2*pi*25e6*t);
```

```
r = sfdr(x,fs,11e6)
```

```
r = 120.0000
```

Display the spectrum of the signal. Annotate the fundamental, the DC value, the spurs, and the SFDR.

```
sfdr(x,fs,11e6);
```

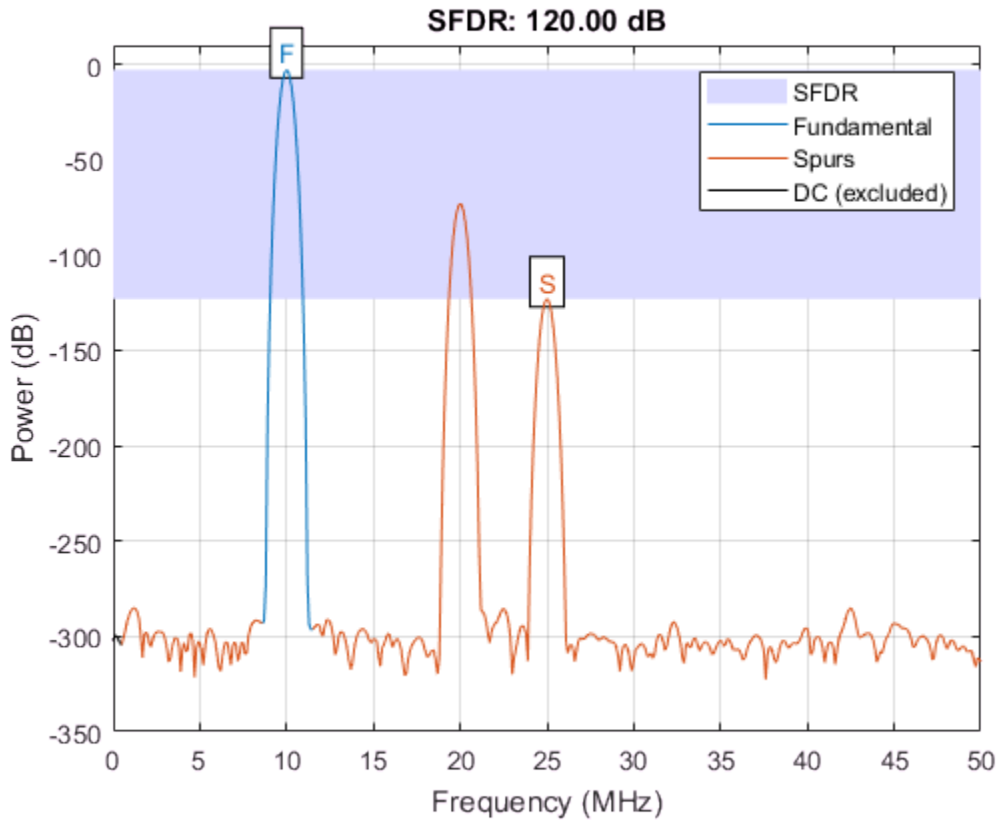

SFDR from Periodogram

Obtain the power spectrum of a 10 MHz tone with amplitude 1 sampled at 100 MHz.

There is a spur at the 1st harmonic (20 MHz) with an amplitude of 3.16×10^{-4} . Use the

one-sided power spectrum and a vector of corresponding frequencies in Hz to compute the SFDR.

```
deltat = 1e-8;
fs = 1/deltat;
t = 0:deltat:1e-6-deltat;
x = cos(2*pi*10e6*t)+3.16e-4*cos(2*pi*20e6*t);
[sxx,f] = periodogram(x,rectwin(length(x)),length(x),fs,'power');
r = sfdr(sxx,f,'power');
```

Display the spectrum of the signal. Annotate the fundamental, the DC value, the first spur, and the SFDR.

```
sfdr(sxx,f,'power');
```

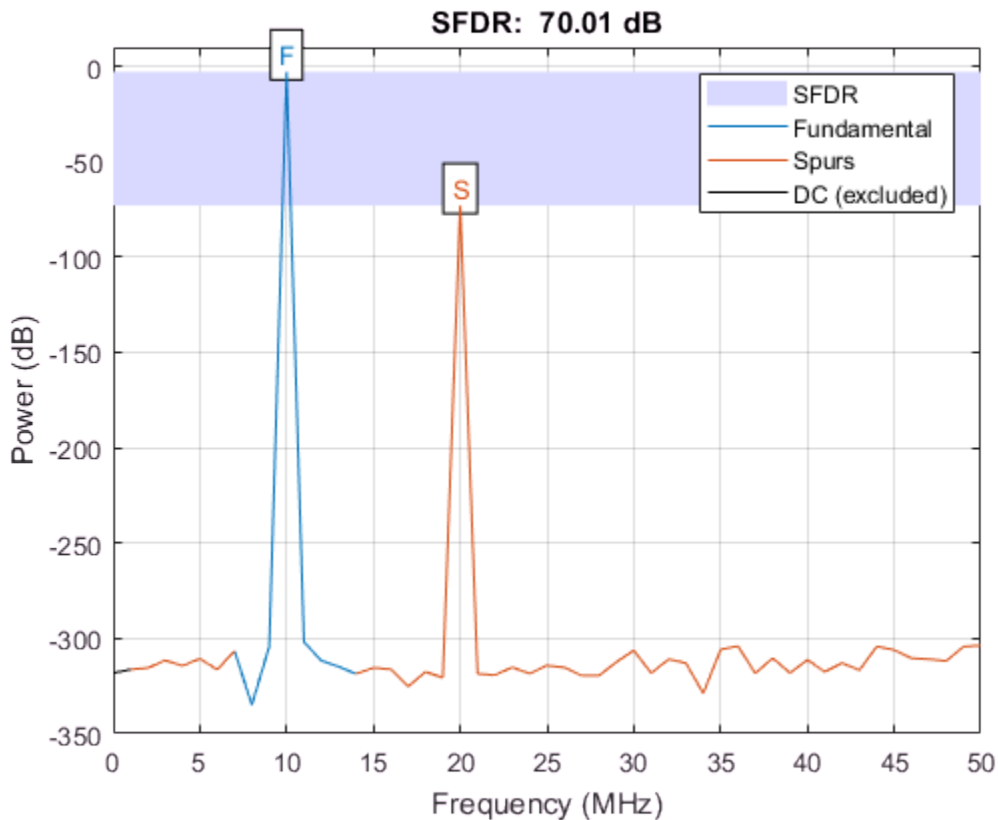

Frequency and Power of Largest Spur

Determine the frequency in MHz for the largest spur. The input signal is a 10 MHz tone with amplitude 1 sampled at 100 MHz. There is a spur at the first harmonic (20 MHz) with an amplitude of 3.16×10^{-4} .

```
deltat = 1e-8;
t = 0:deltat:1e-6-deltat;
x = cos(2*pi*10e6*t)+3.16e-4*cos(2*pi*20e6*t);
[r,spurpow,spurfreq] = sfdr(x,1/deltat);
spur_MHz = spurfreq/1e6
```

```
spur_MHz = 20
```

SFDR from Time Series

Create a superposition of three sinusoids, with frequencies of 9.8, 14.7, and 19.6 kHz, in white Gaussian additive noise. The signal is sampled at 44.1 kHz. The 9.8 kHz sine wave has an amplitude of 1 volt, the 14.7 kHz wave has an amplitude of 100 microvolts, and the 19.6 kHz signal has amplitude 30 microvolts. The noise has 0 mean and a variance of 0.01 microvolt. Additionally, the signal has a DC shift of 0.1 volt.

```
rng default
```

```
Fs = 44.1e3;
f1 = 9.8e3;
f2 = 14.7e3;
f3 = 19.6e3;
N = 900;
```

```
nT = (0:N-1)/Fs;
x = 0.1+sin(2*pi*f1*nT)+100e-6*sin(2*pi*f2*nT) ...
    +30e-6*sin(2*pi*f3*nT)+sqrt(1e-8)*randn(1,N);
```

Plot the spectrum and SFDR of the signal. Display its fundamental and its largest spur. The DC level is excluded from the SFDR computation.

```
sfdr(x,Fs);
```

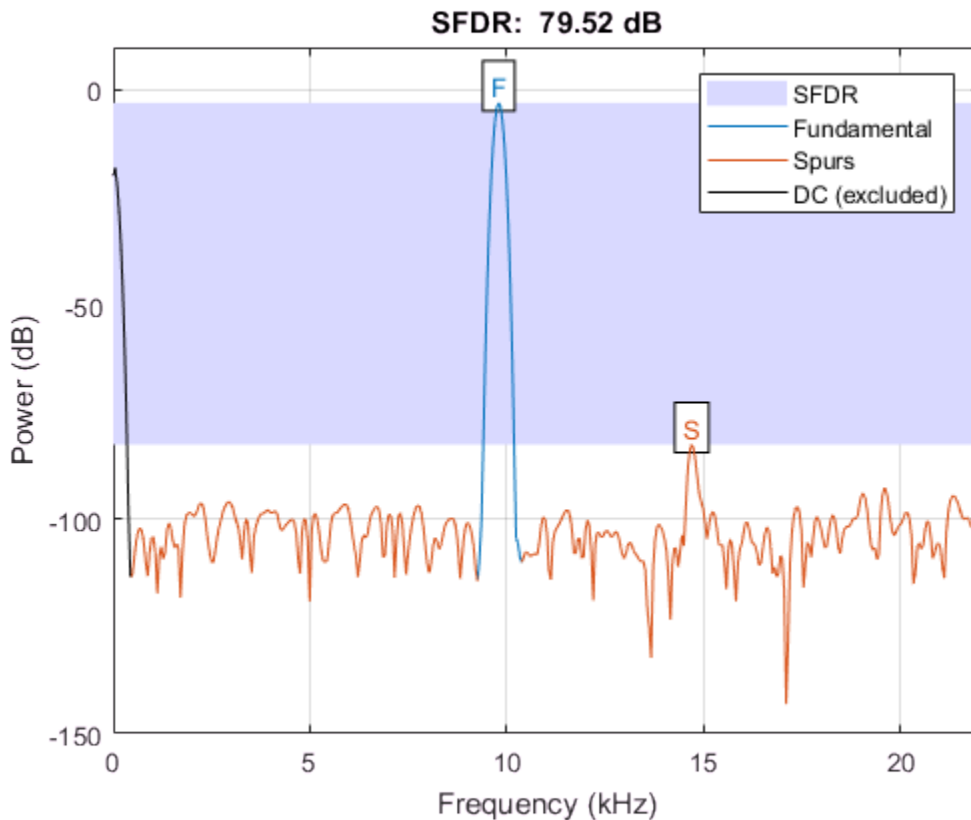
- “Spurious-Free Dynamic Range (SFDR) Measurement”

Input Arguments

x — Real-valued sinusoidal signal

row vector | column vector

Real-valued sinusoidal signal, specified as a row or column vector. The mean is subtracted from **x** prior to obtaining the power spectrum for SFDR computation.

Example: `x = cos(pi/4*(0:79))+1e-4*cos(pi/2*(0:79));`

Data Types: double

fs — Sample rate

1 (default) | positive scalar

Sample rate of the signal in cycles/unit time, specified as a positive scalar. When the unit of time is seconds, **fs** is in Hz.

Data Types: double

msd — Minimum spur distance

0 (default) | positive scalar

Minimum number of discrete Fourier transform (DFT) bins to ignore in the SFDR computation, specified as a positive scalar. You can use this argument to ignore spurs or sidelobes that occur in close proximity to the fundamental frequency. For example, if the carrier frequency is F_c , then all spurs in the range $(F_c - \text{msd}, F_c + \text{msd})$ are ignored.

Data Types: double

sxx — One-sided power spectrum

row or column vector of positive numbers

One-sided power spectrum to use in the SFDR computation, specified as row or column vector.

Data Types: double

f — Vector of frequencies

row or column vector of nonnegative numbers

Vector of frequencies corresponding to the power estimates in **sxx**, specified as a row or column vector.

Output Arguments

r — Spurious free dynamic range

real-valued scalar

Spurious free dynamic range in dB, specified as a real-valued scalar. The spurious free dynamic range is the difference in dB between the power at the peak frequency and the power at the next largest frequency (spur). If the input is time series data, the power

estimates are obtained from a modified periodogram using a Hamming window. The length of the DFT used in the periodogram is equal to the length of the input signal, `x`. If you want to use a different power spectrum as the basis for the SFDR measurement, you can input your power spectrum using the `'power'` flag.

Data Types: `double`

spurpow — power of largest spur

real-valued scalar

Power in dB of the largest spur, specified as a real-valued scalar.

Data Types: `double`

spurfreq — frequency of largest spur

real-valued scalar

Frequency in Hz of the largest spur, specified as a real-valued scalar. If you do not supply the sample rate as an input argument, `sfdr` assumes a sample rate of 1 Hz.

Data Types: `double`

Definitions

Distortion Measurement Functions

The functions `thd`, `sfdr`, `sinad`, and `snr` measure the response of a weakly nonlinear system stimulated by a sinusoid.

When given time-domain input, `sfdr` performs a periodogram using a Kaiser window with large sidelobe attenuation. To find the fundamental frequency, the algorithm searches the periodogram for the largest nonzero spectral component. It then computes the central moment of all adjacent bins that decrease monotonically away from the maximum. To be detectable, the fundamental should be at least in the second frequency bin. If a harmonic lies within the monotonically decreasing region in the neighborhood of another, its power is considered to belong to the larger harmonic. This larger harmonic may or may not be the fundamental. The algorithm ignores all the power that decreases monotonically away from the DC bin.

`sfdr` fails if the fundamental is not the highest spectral component in the signal.

Ensure that the frequency components are far enough apart to accommodate for the sidelobe width of the Kaiser window. If this is not feasible, you can use the 'power' flag and compute a periodogram with a different window.

See Also

See Also

bandpower | enbw | periodogram

Topics

“Spurious-Free Dynamic Range (SFDR) Measurement”

Introduced in R2013a

sgolay

Savitzky-Golay filter design

Syntax

```
b = sgolay(order,framelen)
b = sgolay(order,framelen,weights)
[b,g] = sgolay(...)
```

Description

`b = sgolay(order,framelen)` designs a Savitzky-Golay FIR smoothing filter with polynomial order `order` and frame length `framelen`. `order` must be less than `framelen`, and `framelen` must be odd. If `order = framelen - 1`, the designed filter produces no smoothing.

The output, `b`, is a `framelen`-by-`framelen` matrix whose rows represent the time-varying FIR filter coefficients. In a smoothing filter implementation (for example, `sgolayfilt`), the last $(\text{framelen} - 1) / 2$ rows (each an FIR filter) are applied to the signal during the startup transient, and the first $(\text{framelen} - 1) / 2$ rows are applied to the signal during the terminal transient. The center row is applied to the signal in the steady state.

`b = sgolay(order,framelen,weights)` specifies a weighting vector, `weights`, with length `framelen`, which contains the real, positive-valued weights to be used during the least-squares minimization.

`[b,g] = sgolay(...)` returns the matrix `g` of differentiation filters. Each column of `g` is a differentiation filter for derivatives of order $p - 1$, where p is the column index. Given a signal `x` of length `framelen`, you can find an estimate of the p^{th} order derivative, `xp`, of its middle value from

$$xp((\text{framelen}+1)/2) = (\text{factorial}(p)) * g(:,p+1)' * x$$

Examples

Savitzky-Golay Smoothing of Noisy Sinusoid

Generate a signal that consists of a 0.2 Hz sinusoid embedded in white Gaussian noise and sampled five times a second for 200 seconds.

```
dt = 1/5;  
t = (0:dt:200-dt)';  
  
x = 5*sin(2*pi*0.2*t) + randn(size(t));
```

Use `sgolay` to smooth the signal. Use 21-sample frames and 4th-order polynomials.

```
order = 4;  
framelen = 21;  
  
b = sgolay(order, framelen);
```

Compute the steady-state portion of the signal by convolving it with the center row of `b`.

```
ycenter = conv(x, b((framelen+1)/2, :), 'valid');
```

Compute the transients. Use the last rows of `b` for the startup and the first rows of `b` for the terminal.

```
ybegin = b(end:-1:(framelen+3)/2, :) * x(framelen:-1:1);  
yend = b((framelen-1)/2:-1:1, :) * x(end:-1:end-(framelen-1));
```

Concatenate the transients and the steady-state portion to generate the complete smoothed signal. Plot the original signal and the Savitzky-Golay estimate.

```
y = [ybegin; ycenter; yend];  
plot([x y])  
legend('Noisy Sinusoid', 'S-G smoothed sinusoid')
```

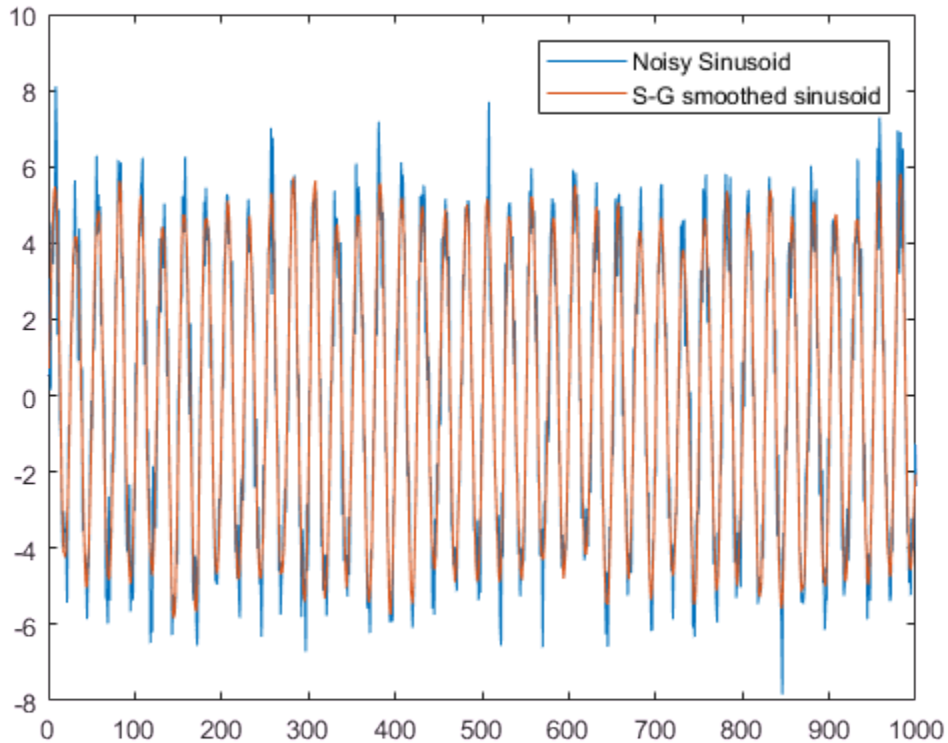

Savitzky-Golay Differentiation

Generate a signal that consists of a 0.2 Hz sinusoid embedded in white Gaussian noise and sampled four times a second for 20 seconds.

```
dt = 0.25;  
t = (0:dt:20-1)';  
  
x = 5*sin(2*pi*0.2*t)+0.5*randn(size(t));
```

Estimate the first three derivatives of the sinusoid using the Savitzky-Golay method. Use 25-sample frames and 5th-order polynomials. Divide the columns by powers of dt to scale the derivatives correctly.

```
[b,g] = sgolay(5,25);  
  
dx = zeros(length(x),4);  
for p = 0:3  
    dx(:,p+1) = conv(x, factorial(p)/(-dt)^p * g(:,p+1), 'same');  
end
```

Plot the original signal, the smoothed sequence, and the derivative estimates.

```
plot(x, '-.')  
hold on  
plot(dx)  
hold off  
  
legend('x', 'x (smoothed)', 'x''', 'x''''', 'x''''''')  
title('Savitzky-Golay Derivative Estimates')
```

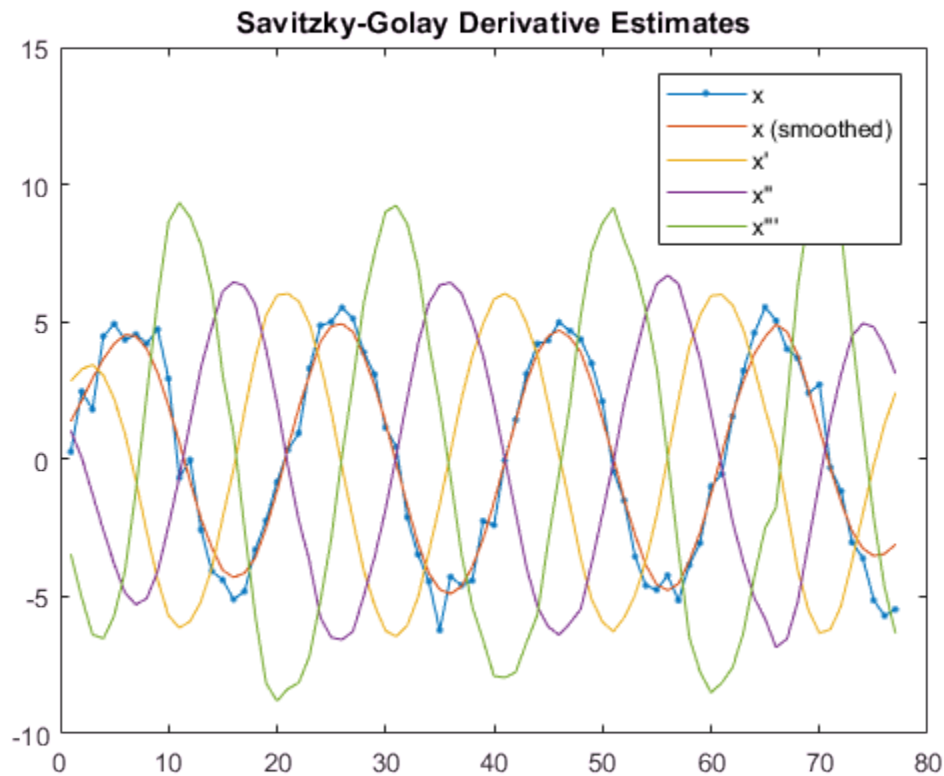
Tips

Savitzky-Golay smoothing filters (also called digital smoothing polynomial filters or least squares smoothing filters) are typically used to “smooth out” a noisy signal whose frequency span (without noise) is large. In this type of application, Savitzky-Golay smoothing filters perform much better than standard averaging FIR filters, which tend to filter out a significant portion of the signal's high frequency content along with the noise. Although Savitzky-Golay filters are more effective at preserving the pertinent high frequency components of the signal, they are less successful than standard averaging FIR filters at rejecting noise when noise levels are particularly high. The particular

formulation of Savitzky-Golay filters preserves various moment orders better than other smoothing methods, which tend to preserve peak widths and heights better than Savitzky-Golay.

Savitzky-Golay filters are optimal in the sense that they minimize the least-squares error in fitting a polynomial to each frame of noisy data.

References

[1] Orfanidis, Sophocles J. *Introduction to Signal Processing*. Englewood Cliffs, NJ: Prentice Hall, 1996.

Extended Capabilities

C/C++ Code Generation

Generate C and C++ code using MATLAB® Coder™.

See Also

See Also

`filter` | `fir1` | `firls` | `sgolayfilt`

Introduced before R2006a

sgolayfilt

Savitzky-Golay filtering

Syntax

```
y = sgolayfilt(x,order,framelen)
y = sgolayfilt(x,order,framelen,weights)
y = sgolayfilt(x,order,framelen,weights,dim)
```

Description

`y = sgolayfilt(x,order,framelen)` applies a Savitzky-Golay FIR smoothing filter to the data in vector `x`. If `x` is a matrix, `sgolayfilt` operates on each column. The polynomial order, `order`, must be less than the frame length, `framelen`, and in turn `framelen` must be odd. If `order = framelen - 1`, the filter produces no smoothing.

`y = sgolayfilt(x,order,framelen,weights)` specifies a weighting vector, `weights`, with length `framelen`, which contains the real, positive-valued weights to be used during the least-squares minimization. If `weights` is not specified, or if it is specified as empty, `[]`, it defaults to an identity matrix.

`y = sgolayfilt(x,order,framelen,weights,dim)` specifies the dimension, `dim`, along which the filter operates. If `dim` is not specified, `sgolayfilt` operates along the first nonsingleton dimension; that is, dimension 1 for column vectors and nontrivial matrices, and dimension 2 for row vectors.

Examples

Steady-State and Transient Savitzky-Golay Filters

Generate a random signal and smooth it using `sgolayfilt`. Specify a polynomial order of 3 and a frame length of 11. Plot the original and smoothed signals.

```
order = 3;
framelen = 11;
```

```
lx = 34;  
x = randn(lx,1);  
  
sgf = sgolayfilt(x,order,framelen);  
  
plot(x,':')  
hold on  
plot(sgf,'.-')  
legend('signal','sgolay')
```

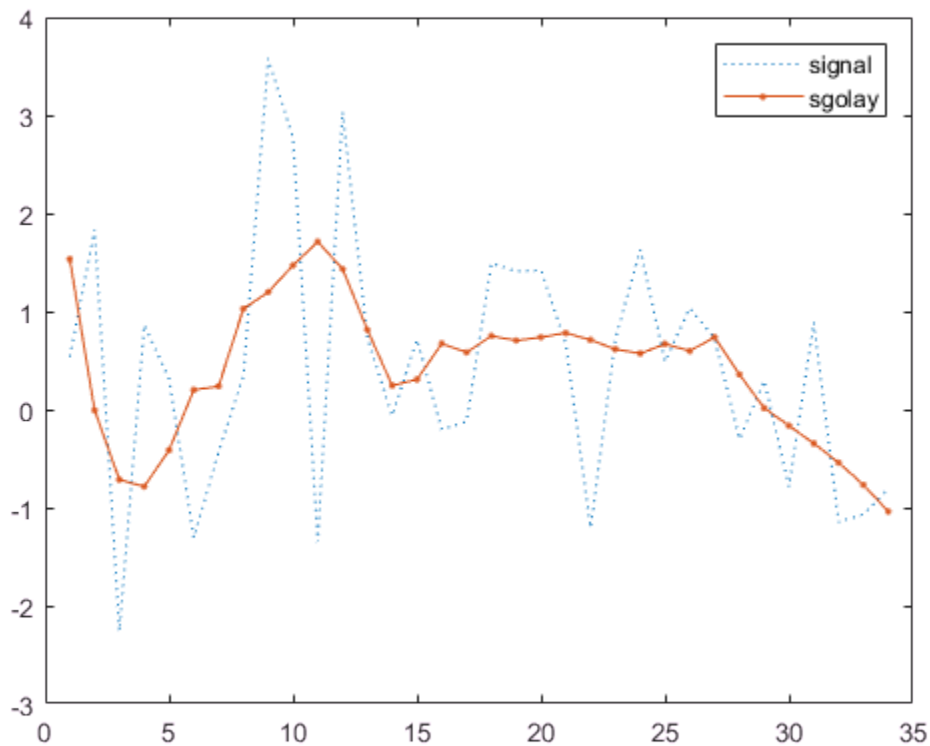

The `sgolayfilt` function performs most of the filtering by convolving the signal with the center row of `B`, the output of `sgolay`. The result is the steady-state portion of the filtered signal. Generate and plot this portion.

```
m = (framelen-1)/2;  
B = sgolay(order,framelen);  
steady = conv(x,B(m+1,:), 'same');  
plot(steady)  
legend('signal', 'sgolay', 'steady')
```

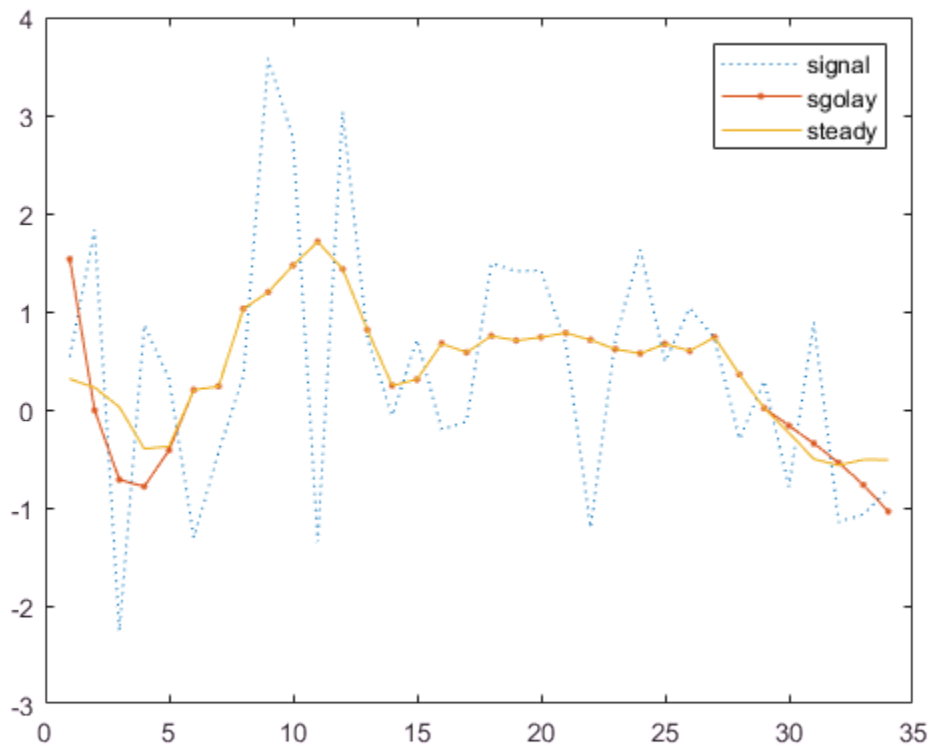

Samples close to the signal edges cannot be placed at the center of a symmetric window and have to be treated differently.

To determine the startup transient, matrix multiply the first $(\text{framelen}-1)/2$ rows of B by the first framelen samples of the signal.

```
ybeg = B(1:m,:)*x(1:frameLen);
```

To determine the terminal transient, matrix multiply the final $(\text{frameLen} - 1) / 2$ rows of B by the final frameLen samples of the signal.

```
yend = B(frameLen-m+1:frameLen,:)*x(lx-frameLen+1:lx);
```

Concatenate the transients and the steady-state portion to generate the complete signal.

```
cmplt = steady;  
cmplt(1:m) = ybeg;  
cmplt(lx-m+1:lx) = yend;  
  
plot(cmplt)  
legend('signal', 'sgolay', 'steady', 'complete')  
hold off
```

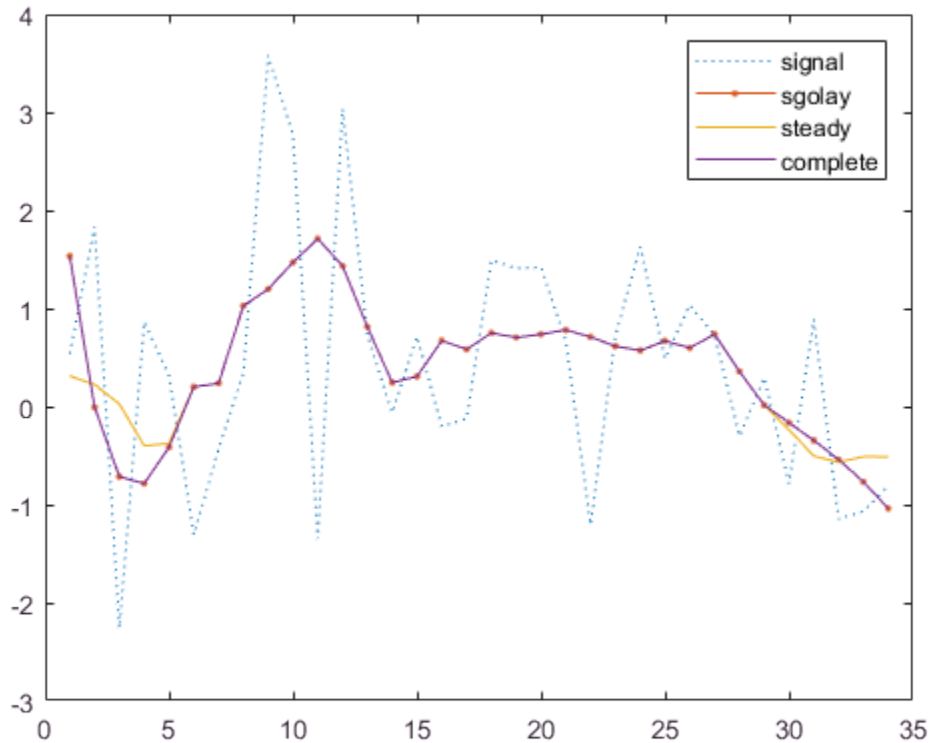

Adding weights to the minimization breaks the symmetry of B and requires extra steps for a proper solution.

Savitzky-Golay Filtering of a Speech Signal

Smooth the `mtlb` signal by applying a cubic Savitzky-Golay filter to data frames of length 41.

```
load mtlb
smtlb = sgolayfilt(mtlb,3,41);

subplot(2,1,1)
plot(1:2000, mtlb(1:2000))
```

```
axis([0 2000 -4 4])  
title('mtlb')  
grid  
  
subplot(2,1,2)  
plot(1:2000,smtlb(1:2000))  
axis([0 2000 -4 4])  
title('smtlb')  
grid
```

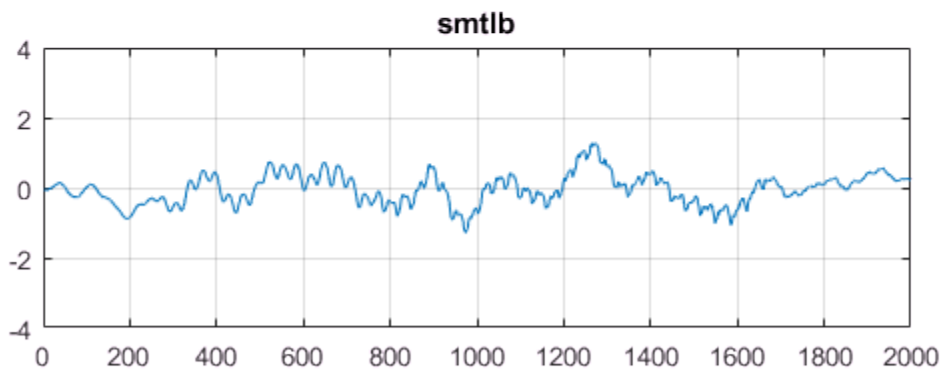
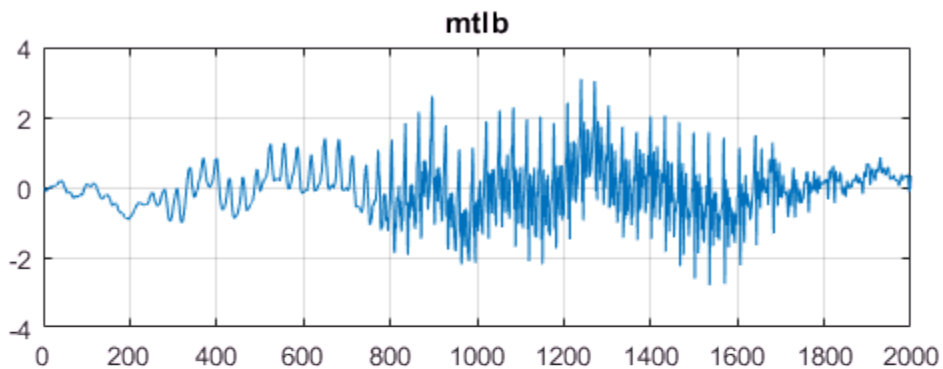

Tips

Savitzky-Golay smoothing filters (also called digital smoothing polynomial filters or least-squares smoothing filters) are typically used to “smooth out” a noisy signal whose frequency span (without noise) is large. In this type of application, Savitzky-Golay smoothing filters perform much better than standard averaging FIR filters, which tend to filter out a significant portion of the signal's high frequency content along with the noise. Although Savitzky-Golay filters are more effective at preserving the pertinent high frequency components of the signal, they are less successful than standard averaging FIR filters at rejecting noise.

Savitzky-Golay filters are optimal in the sense that they minimize the least-squares error in fitting a polynomial to frames of noisy data.

References

- [1] Orfanidis, Sophocles J. *Introduction to Signal Processing*. Englewood Cliffs, NJ: Prentice-Hall, 1996.

Extended Capabilities

C/C++ Code Generation

Generate C and C++ code using MATLAB® Coder™.

See Also

See Also

`filter` | `medfilt1` | `sgolay` | `sosfilt`

Introduced before R2006a

shiftdata

Shift data to operate on specified dimension

Syntax

```
[x,perm,nshifts] = shiftdata(x,dim)
```

Description

`[x,perm,nshifts] = shiftdata(x,dim)` shifts data `x` to permute dimension `dim` to the first column using the same permutation as the built-in `filter` function. The vector `perm` returns the permutation vector that is used.

If `dim` is missing or empty, then the first nonsingleton dimension is shifted to the first column, and the number of shifts is returned in `nshifts`.

`shiftdata` is meant to be used in tandem with `unshiftdata`, which shifts the data back to its original shape. These functions are useful for creating functions that work along a certain dimension, like `filter`, `goertzel`, `sgolayfilt`, and `sosfilt`.

Examples

Permute Dimensions of a Magic Square

This example shifts `x`, a 3-by-3 magic square, permuting dimension 2 to the first column. `unshiftdata` shifts `x` back to its original shape.

Create a 3-by-3 magic square.

```
x = magic(3)
```

```
x =
```

```
8     1     6
3     5     7
4     9     2
```

Shift the matrix `x` to work along the second dimension. The permutation vector, `perm`, and the number of shifts, `nshifts`, are returned along with the shifted matrix.

```
[x,perm,nshifts] = shiftdata(x,2)
```

```
x =
```

```

     8     3     4
     1     5     9
     6     7     2

```

```
perm =
```

```

     2     1

```

```
nshifts =
```

```

     []

```

Shift the matrix back to its original shape.

```
y = unshiftdata(x,perm,nshifts)
```

```
y =
```

```

     8     1     6
     3     5     7
     4     9     2

```

Rearrange Array to Operate on First Nonsingleton Dimension

This example shows how `shiftdata` and `unshiftdata` work when you define `dim` as empty.

Define `x` as a row vector.

```
x = 1:5
```

```
x =
```

```
1 2 3 4 5
```

Define `dim` as empty to shift the first non-singleton dimension of `x` to the first column. `shiftdata` returns `x` as a column vector, along with `perm`, the permutation vector, and `nshifts`, the number of shifts.

```
[x,perm,nshifts] = shiftdata(x,[])
```

```
x =
```

```
1  
2  
3  
4  
5
```

```
perm =
```

```
[]
```

```
nshifts = 1
```

Using `unshiftdata`, restore `x` to its original shape.

```
y = unshiftdata(x,perm,nshifts)
```

```
y =
```

```
1 2 3 4 5
```

See Also

[permute](#) | [shiftdim](#) | [unshiftdata](#)

Introduced in R2012b

Signal Analyzer

Visualize and compare multiple signals and spectra

Description

The **Signal Analyzer** app is an interactive tool for visualizing, measuring, analyzing, and comparing signals, in the time domain, in the frequency domain, and in the time-frequency domain. Using the app, you can:

- Easily access all the signals in the MATLAB workspace
- Interact simultaneously with waveform, spectrum, and spectrogram representations of signals
- Visualize and compare multiple signals, spectra, and spectrograms at once

The **Signal Analyzer** app provides a way to work with many signals of varying durations at the same time and in the same view.

A typical workflow for inspecting and comparing signals using the app is:

- 1 Select signals to analyze — Select any signal available in the MATLAB workspace. The app accepts numeric arrays and signals with inherent time information, such as MATLAB timetables and `timeseries` objects.
- 2 Explore signals — Plot, measure, and compare data, their spectra, or their spectrograms. Look for features and patterns in the time domain, in the frequency domain, and in the time-frequency domain. Specify sample rates of signals with no inherent time information. Add time information to such signals using numeric vectors, `duration` arrays, or MATLAB expressions.
- 3 Share analysis — Copy displays from the app to the clipboard as images.
- 4 Save and load **Signal Analyzer** sessions — Resume your analysis later or in another machine.

Open the Signal Analyzer App

- MATLAB Toolstrip: On the **Apps** tab, under **Signal Processing and Communications**, click the app icon.
- MATLAB command prompt: Enter `signalAnalyzer`.

Examples

Analyze Signals with Inherent Time Information

Load a file that contains measurements of the international normalized ratio (INR) performed on a patient over a five-year period. The INR measures the effect of warfarin, a blood thinner used to treat people predisposed to clotting.

The file includes a `datetime` array with the date and time of each measurement, and a vector of INR readings. Display the first five time points.

```
load(fullfile(matlabroot, 'examples', 'signal', 'INR.mat'))
```

```
Date(1:5)
```

```
ans =
```

```
5×1 datetime array
```

```
05/15/09 11:28 AM  
06/16/09 09:05 AM  
07/02/09 09:50 AM  
07/16/09 11:20 AM  
07/31/09 12:05 PM
```

Convert the time readings to a `duration` array by subtracting the first time point. Convert the `duration` array to seconds.

```
t = Date-Date(1);  
s = seconds(t);
```

Create a timetable with the `duration` array and the INR readings.

```
TT = timetable(t, INR);
```

Create a `timeseries` object with the time in seconds and the INR readings.

```
ts = timeseries(INR, s, 'Name', 'inr');
```

Open **Signal Analyzer**. Under **Display Grid**, select three displays.

- 1 Drag the timetable to the first display. The app calls this signal `TT.INR`.
- 2 Drag the `timeseries` object to the second display. The app calls this signal `ts.inr`.

- 3 Drag the array of INR readings to the third display. Add time information. Select the signal by clicking its legend. From the **Analyzer** tab, click **Time Values**. Select the **Time Values** option and in the **Time Values** field, enter **t**.

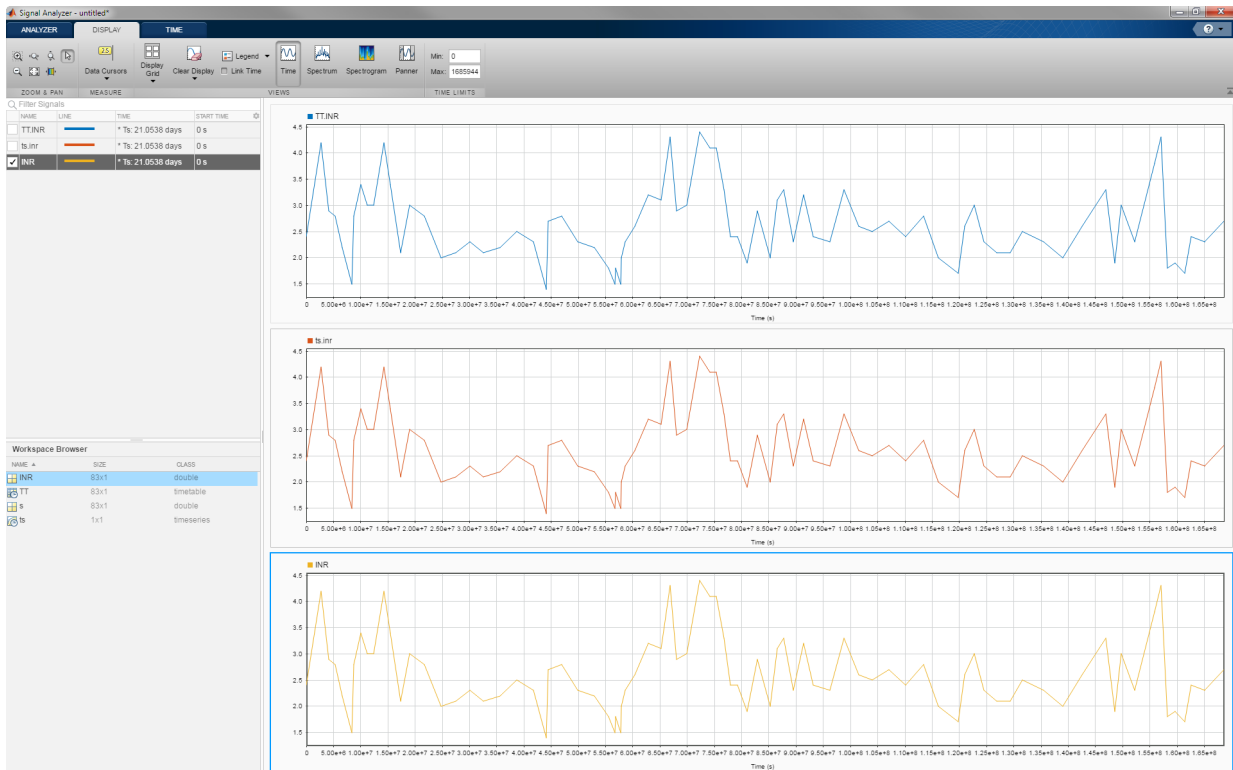

Spectrogram View of Dial Tone Signal

Create a signal, sampled at 4 kHz, that resembles dialing all the keys of a digital telephone. Save the signal as a MATLAB® timetable.

```
fs = 4e3;
t = 0:1/fs:0.5-1/fs;
```

```
ver = [697 770 852 941];
hor = [1209 1336 1477];
```

```
tones = [];
```

```
for k = 1:length(ver)
    for l = 1:length(hor)
        tone = sum(sin(2*pi*[ver(k);hor(l)].*t))');
        tones = [tones;tone;zeros(size(tone))];
    end
end
```

```
% To hear, type soundsc(tones,fs)
```

```
S = timetable(seconds(0:length(tones)-1)'/fs,tones);
```

Open **Signal Analyzer** and drag the timetable to a display. Add a **Spectrogram** view. On the **Spectrogram** tab, under **Time Resolution**, select **Specify**. Enter a time resolution of 0.5 second and zero overlap between adjoining segments.

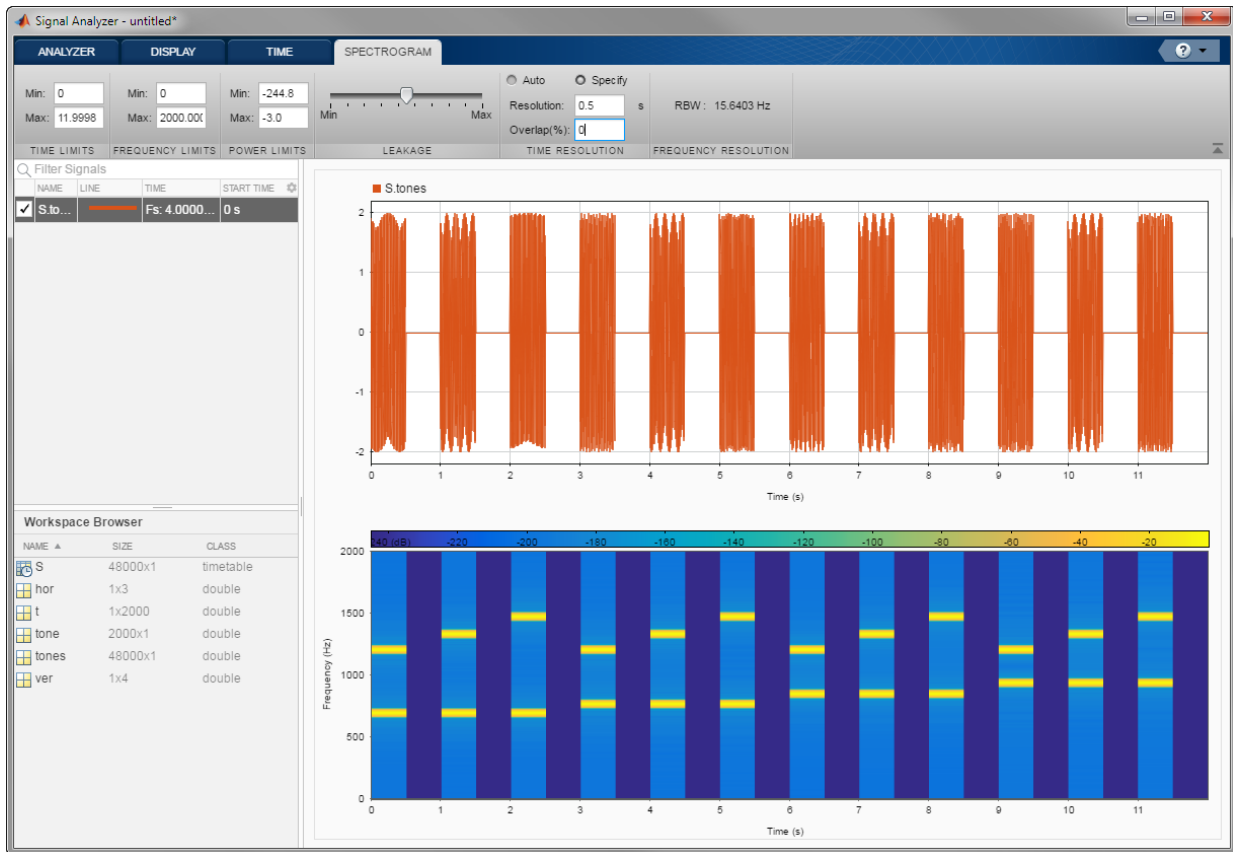

The spectrogram view shows that each key is dialed for half a second, with half-second silent pauses between keys. The first tone has its frequency content concentrated around 697 Hz and 1209 Hz, corresponding to the digit '1' in the DTMF standard.

- Getting Started with Signal Analyzer App
- “Find Delay Between Correlated Signals”
- “Plot Signals from the Command Line”
- “Resolve Tones by Varying Window Leakage”

Programmatic Use

signalAnalyzer opens the **Signal Analyzer** app.

`signalAnalyzer(sig)` opens the **Signal Analyzer** app and imports and plots the signal `sig`. If the app is already open, then it plots `sig` in the current display. If `sig` is already plotted but has changed, then the function call updates the plot.

`sig` can be a variable in the workspace or a MATLAB expression. `sig` can be:

- A vector or a matrix with independent signals in each column.
- A `timetable` with time values specified as durations.
- A timeseries object.

By default, the app plots the signal as a function of sample index. If you provide time information, or if the signal has inherent time information, then the app plots the signal as a function of time.

`signalAnalyzer(sig1, ..., sigN)` imports N signal vectors or matrices and plots them in the current display. The app does not support importing signals with inherent time information and signals without inherent time information in the same function call.

`signalAnalyzer(____, 'SampleRate', fs)` specifies a sample rate, `fs`, as a positive scalar expressed in Hz. The app uses the sample rate to plot one or more signals against time, assuming a start time of zero. You can specify a sample rate for signals with no inherent time information.

`signalAnalyzer(____, 'SampleTime', ts)` specifies a sample time, `ts`, as a positive scalar expressed in seconds. The app uses the sample time to plot one or more signals against time, assuming a start time of zero. You can specify a sample time for signals with no inherent time information.

`signalAnalyzer(____, 'StartTime', st)` specifies a signal start time, `st`, as a scalar expressed in seconds. If you do not specify a sample rate or sample time, then the app assumes a sample rate of 1 Hz. You can specify a start time for signals with no inherent time information.

`signalAnalyzer(____, 'TimeValues', tv)` specifies a vector, `tv`, with time values corresponding to the data points. `tv` can be a real numeric vector with values expressed in seconds. `tv` can also be a `duration` array. The values in `tv` must be unique and cannot be `NaN`, but they need not be uniformly spaced. All input signals must have the same length as `tv`. You can specify a vector of time values for signals with no inherent time information.

See Also

See Also

Apps

Filter Designer

Functions

periodogram | pwelch | spectrogram

Topics

Getting Started with Signal Analyzer App

“Find Delay Between Correlated Signals”

“Plot Signals from the Command Line”

“Resolve Tones by Varying Window Leakage”

“Edit Sample Rate and Other Time Information”

“Spectrum Computation in Signal Analyzer”

“Spectrogram Computation in Signal Analyzer”

“Keyboard Shortcuts for the Signal Analyzer App”

Introduced in R2016a

sigwin

Signal processing window object

Syntax

```
w = sigwin.window
```

Description

Note: The use of `sigwin.window` is not recommended. Use the corresponding function instead. See “Windows” on page 1-1854 for the functional forms.

`w = sigwin.window` returns a window object, `w`, of type `window`. Each window type takes one or more inputs. If you specify a `sigwin.window` with no inputs, a default window of length 64 is created.

Note You must specify a `window` type with `sigwin`.

Windows

`window` for `sigwin` specifies the type of window. The following table lists the supported window functions with links to the corresponding class reference page for the window object.

Window	Window Object	Corresponding Function
Modified Bartlett-Hann Window	<code>sigwin.barthannwin</code>	<code>barthannwin</code>
Bartlett Window	<code>sigwin.bartlett</code>	<code>bartlett</code>
Blackman Window	<code>sigwin.blackman</code>	<code>blackman</code>
Blackman-Harris Window	<code>sigwin.blackmanharris</code>	<code>blackmanharris</code>
Bohman Window	<code>sigwin.bohmanwin</code>	<code>bohmanwin</code>

Window	Window Object	Corresponding Function
Dolph-Chebyshev Window	sigwin.chebwin	chebwin
Flat Top Window	sigwin.flattopwin	flattopwin
Gaussian Window	sigwin.gausswin	gausswin
Hamming Window	sigwin.hamming	hamming
Hann (Hanning) Window	sigwin.hann	hann
Kaiser Window	sigwin.kaiser	kaiser
Nuttall defined 4-term Blackman-Harris Window	sigwin.nuttallwin	nuttallwin
Parzen Window	sigwin.parzenwin	parzenwin
Rectangular Window	sigwin.rectwin	rectwin
Taylor Window	sigwin.taylorwin	taylorwin
Triangular Window	sigwin.triang	triang
Tukey Window	sigwin.tukeywin	tukeywin

Methods

Methods provide ways of performing functions directly on your `sigwin` object without having to specify the window parameters again. You can apply this method directly on the variable you assigned to your `sigwin` object.

Method	Description
<code>generate</code>	Returns a column vector of values representing the window.
<code>info</code>	Returns information about the window object.
<code>winwrite</code>	Writes an ASCII file that contains window weights for a single window object or a vector of window objects. Default filename is <code>untitled.wf</code> . <code>winwrite(Hd, filename)</code> writes to a disk file named <code>filename</code> in the current

Method	Description
	working directory. The <code>.wf</code> extension is added automatically.

Viewing Object Parameters

As with any object, you can use `get` to view a `sigwin` object's parameters. To see a specific parameter,

```
get(w, 'parameter')
```

or to see all parameters for an object,

```
get(w)
```

Changing Object Parameters

To set specific parameters,

```
set(w, 'parameter1', value, 'parameter2', value, ...)
```

Note that you must use single quotation marks around the parameter name.

Examples

Bartlett window Object

Create a default Bartlett window and view the result in `wvtool`. See `bartlett` for information on Bartlett windows.

```
w = sigwin.bartlett
```

```
w =  
    Name: 'Bartlett'  
    Length: 64
```

```
wvtool(w)
```

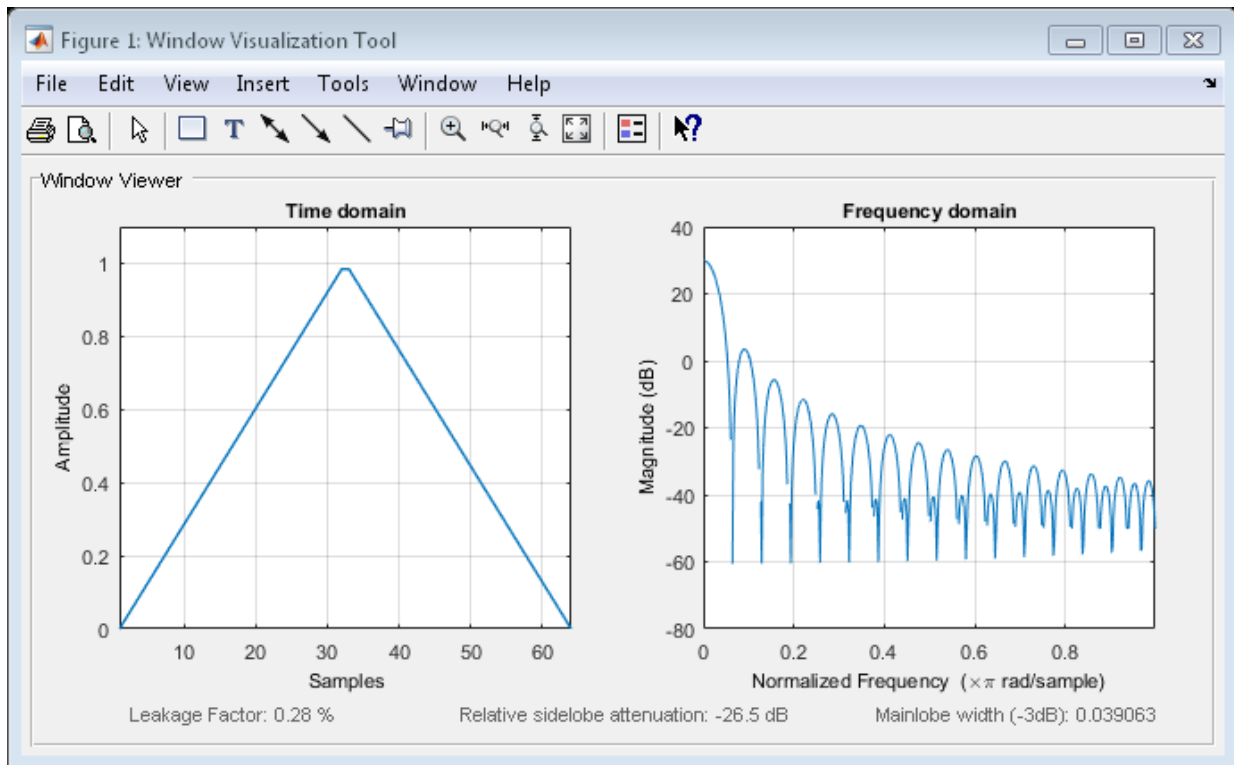

Chebyshev Window Object

Create a 128-point Chebyshev window with 100 dB of sidelobe attenuation. (See `chebwin` for information on Chebyshev windows.) View the result with `wvtool`.

```
w = sigwin.chebwin(128,100)
```

```
w =
      Name: 'Chebyshev'
      Length: 128
      SidelobeAtten: 100
```

```
wvtool(w)
```

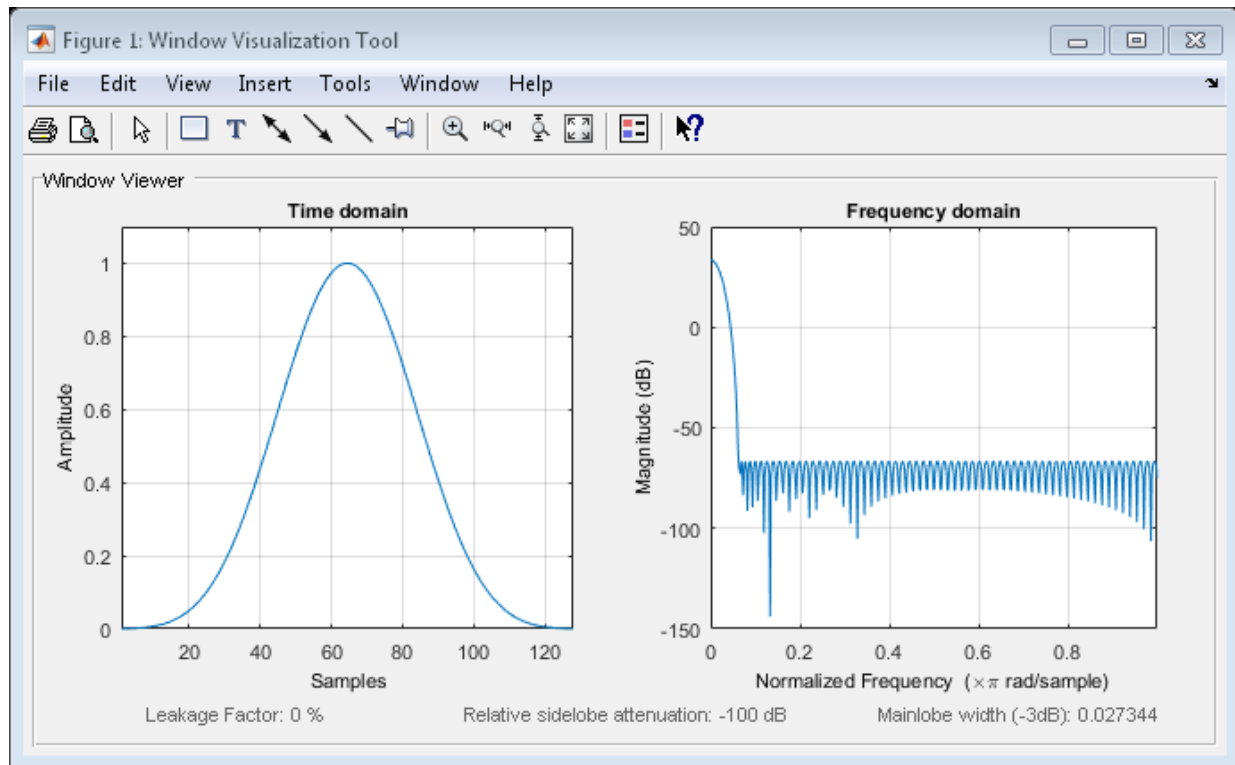

Save Window Object as Vector

Create a Hamming window of length 12. Visualize the result.

```
H = sigwin.hamming(12);  
wvtool(H)
```

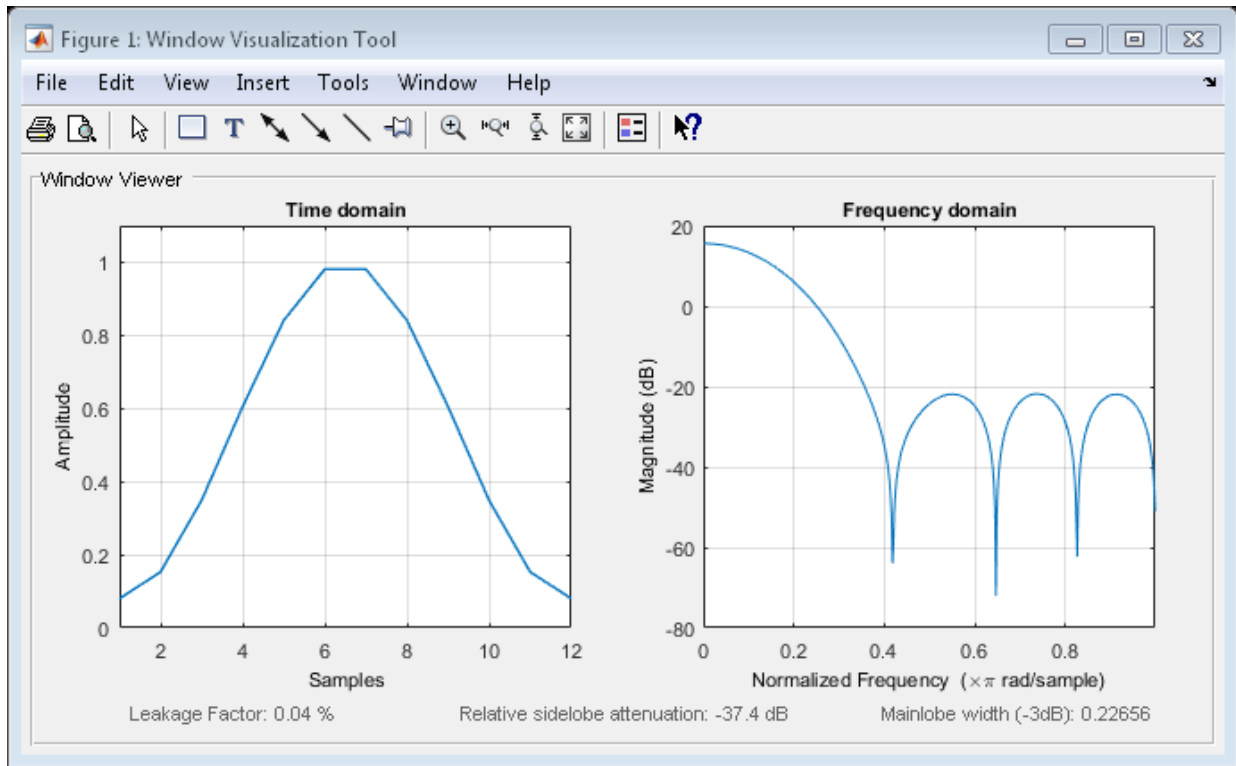
Save the window values in a column vector.

```
d = generate(H)'
```

```
d =
```

```
0.0800 0.1530 0.3489 0.6055 0.8412 0.9814 0.9814 0.8412 0.6055 0.3489 0.1530 0.0800
```

See Also

See Also

Apps

Window Designer

Functions

window | wvtool

Introduced before R2006a

sigwin.barthannwin class

Package: sigwin

Construct modified Bartlett-Hann window object

Description

Note: The use of `sigwin.barthannwin` is not recommended. Use `barthannwin` instead.

`sigwin.barthannwin` creates a handle to a modified Bartlett-Hann window object for use in spectral analysis and FIR filtering by the window method. Object methods enable workspace import and ASCII file export of the window values.

The following equation defines a modified Bartlett-Hann window of length N :

$$w(x) = 0.62 - 0.48|x| + 0.38 \cos 2\pi x, \quad -\frac{1}{2} \leq x \leq \frac{1}{2}$$

where x is an N -point linearly spaced vector over the interval $[1/2, 1/2]$.

Construction

`H = sigwin.barthannwin` returns a modified Bartlett-Hann window object `H` of length 64.

`H = sigwin.barthannwin(Length)` returns a modified Bartlett-Hann window object `H` of length *Length*. *Length* requires a positive integer. Entering a positive noninteger value for *Length* rounds the length to the nearest integer. Entering a 1 for *Length* results in a window with a single value of 1.

Properties

Length

Modified Bartlett-Hann window length. The window length requires a positive integer. Entering a positive noninteger value for *Length* rounds the length to the nearest integer. Entering a 1 for *Length* results in a window with a single value of 1.

Methods

generate	Generates modified Bartlett-Hann window
info	Display information about modified Bartlett-Hann window object
winwrite	Save modified Bartlett-Hann window object values in ASCII file

Copy Semantics

Handle. To learn how copy semantics affect your use of the class, see Copying Objects (MATLAB) in the MATLAB Programming Fundamentals documentation.

Examples

Modified Bartlett-Hann Window

Generate a modified Bartlett-Hann window of length $N = 16$. Return its values as a column vector. Write the coefficients to an ASCII file in the current directory. Show information about the window object. Display the window.

```
H = sigwin.barthannwin(16);
```

```
win = generate(H)
```

```
win =
```

```
      0  
 0.0649  
 0.1897
```

```

0.3586
0.5477
0.7300
0.8794
0.9757
0.9757
0.8794

```

```

winwrite(H, 'barthannwin_16');
wininfo = info(H)

```

```

wininfo = 3x23 char array
    'Bartlett-Hanning Window'
    '-----'
    'Length : 16'

```

```

wvtool(H)

```

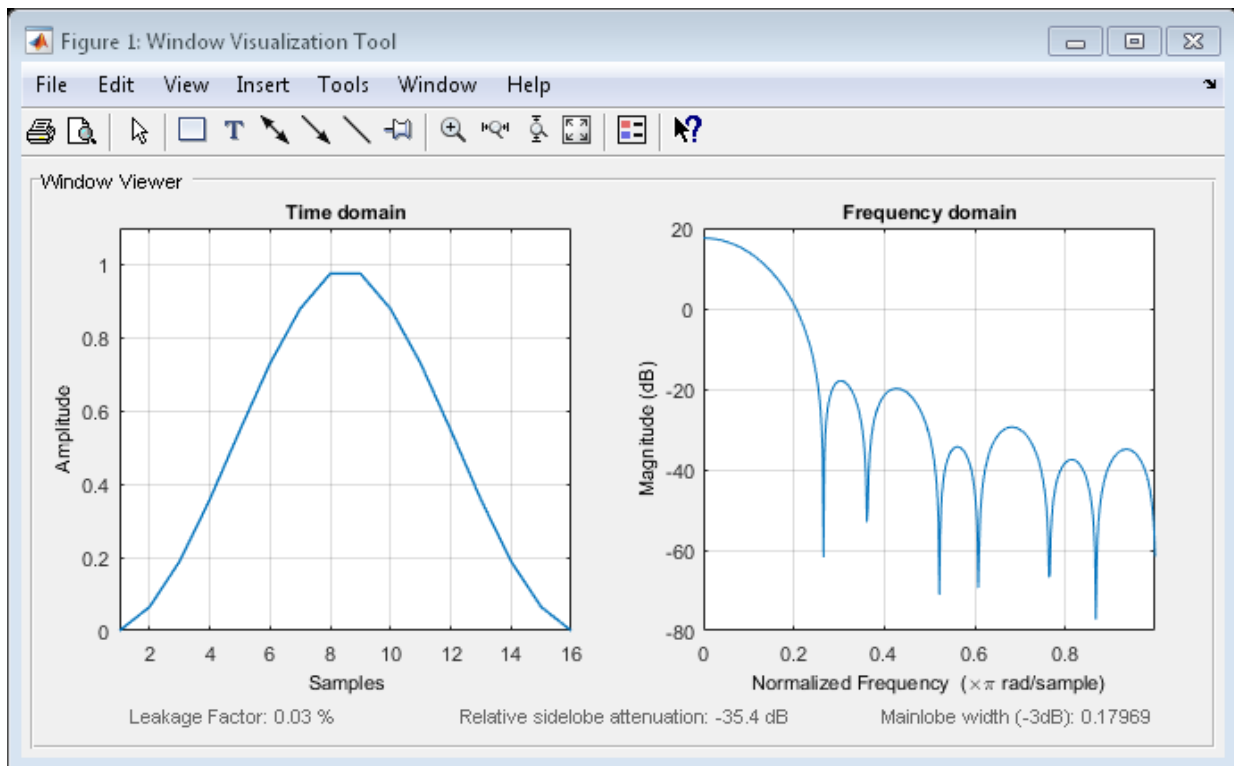

References

Yeong, H. H., and Pearce, J. A. “A New Window and Comparison to Standard Windows.” *IEEE Transactions on Acoustics, Speech and Signal Processing*, Vol. 37, 1989, pp. 298–301.

See Also

See Also

`barthannwin` | `window` | `wvtool`

Topics

“Windows”

Class Attributes (MATLAB)

Property Attributes (MATLAB)

generate

Class: sigwin.barthannwin

Package: sigwin

Generates modified Bartlett-Hann window

Syntax

```
win = generate(H)
```

Description

`win = generate(H)` returns the values of the modified Bartlett-Hann window object `H` as a double-precision column vector.

Examples

Modified Bartlett-Hann Window

Generate a modified Bartlett-Hann window of length $N = 16$. Return its values as a column vector. Write the coefficients to an ASCII file in the current directory. Show information about the window object. Display the window.

```
H = sigwin.barthannwin(16);
```

```
win = generate(H)
```

```
win =
```

```
      0  
0.0649  
0.1897  
0.3586  
0.5477  
0.7300
```

```
0.8794
0.9757
0.9757
0.8794
```

```
winwrite(H, 'barthannwin_16');
wininfo = info(H)
```

```
wininfo = 3×23 char array
    'Bartlett-Hanning Window'
    '-----'
    'Length : 16'
```

```
wvtool(H)
```

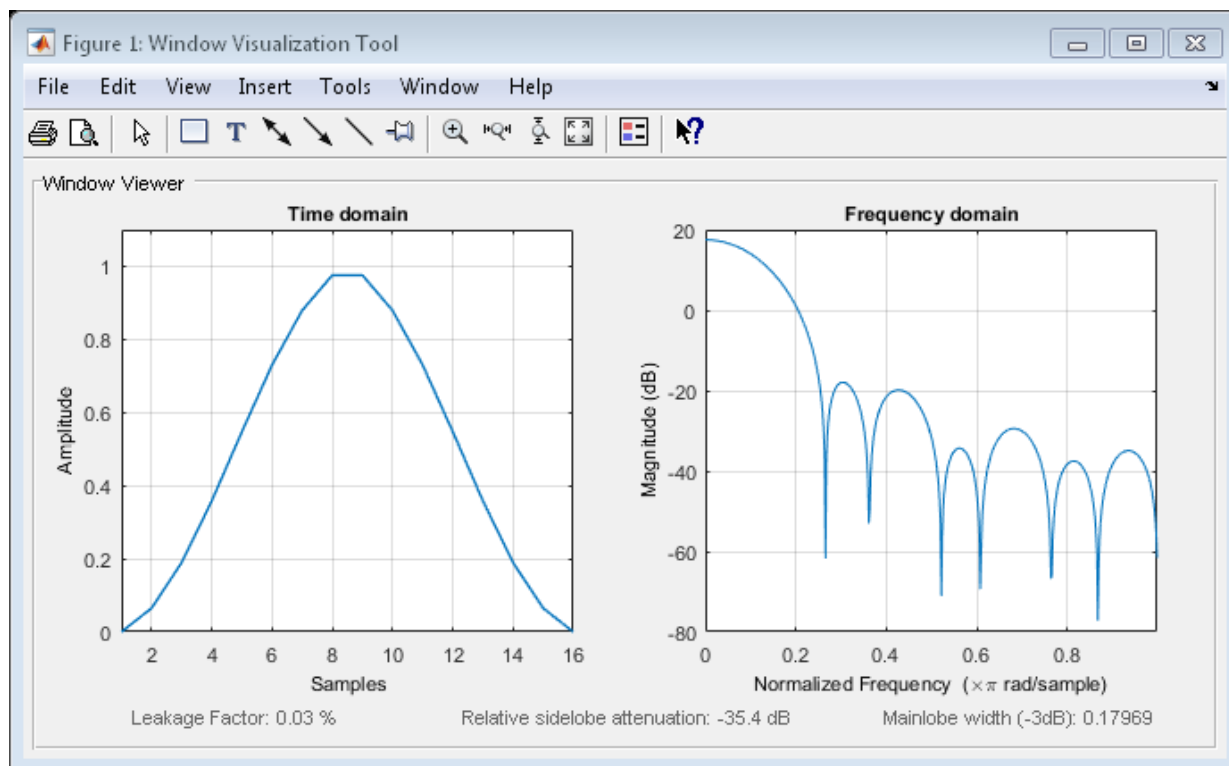

See Also

See Also

[barthannwin](#) | [window](#) | [wvtool](#)

info

Class: sigwin.barthannwin

Package: sigwin

Display information about modified Bartlett-Hann window object

Syntax

```
info(H)
info_win = info(H)
```

Description

`info(H)` displays length information for the modified Bartlett-Hann window object `H`.

`info_win = info(H)` returns length information for the modified Bartlett-Hann window object `H` in the character array `info_win`.

Examples

Modified Bartlett-Hann Window

Generate a modified Bartlett-Hann window of length $N = 16$. Return its values as a column vector. Write the coefficients to an ASCII file in the current directory. Show information about the window object. Display the window.

```
H = sigwin.barthannwin(16);
```

```
win = generate(H)
```

```
win =
```

```
      0
0.0649
0.1897
0.3586
0.5477
```

```

0.7300
0.8794
0.9757
0.9757
0.8794

```

```

winwrite(H,'barthannwin_16');
wininfo = info(H)

```

```

wininfo = 3×23 char array
    'Bartlett-Hanning Window'
    '-----'
    'Length : 16'

```

```

wvtool(H)

```

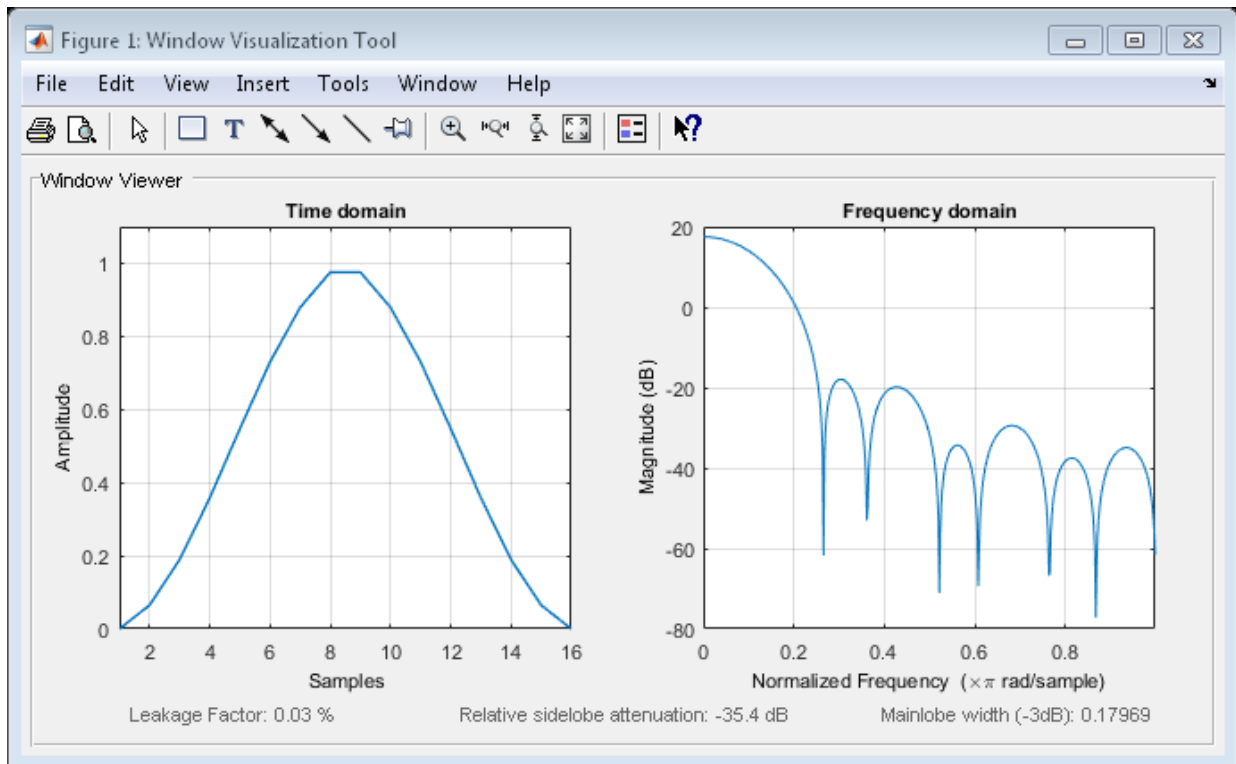

See Also

See Also

barthannwin | window | wvtool

winwrite

Class: sigwin.barthannwin

Package: sigwin

Save modified Bartlett-Hann window object values in ASCII file

Syntax

```
winwrite(H)
winwrite(H, 'filename')
```

Description

`winwrite(H)` opens a dialog box that enables you to export the values of the modified Bartlett-Hann window object `H` to an ASCII file with filename extension `wf`.

`winwrite(H, 'filename')` saves the values of the modified Bartlett-Hann window object `H` in the current folder as a column vector in the ASCII file `'filename'`. The filename extension is `wf`.

Examples

Modified Bartlett-Hann Window

Generate a modified Bartlett-Hann window of length $N = 16$. Return its values as a column vector. Write the coefficients to an ASCII file in the current directory. Show information about the window object. Display the window.

```
H = sigwin.barthannwin(16);
```

```
win = generate(H)
```

```
win =
```

```
      0
0.0649
0.1897
0.3586
```

```
0.5477
0.7300
0.8794
0.9757
0.9757
0.8794
```

```
winwrite(H,'barthannwin_16');
wininfo = info(H)
```

```
wininfo = 3×23 char array
    'Bartlett-Hanning Window'
    '-----'
    'Length : 16'
```

```
wvtool(H)
```

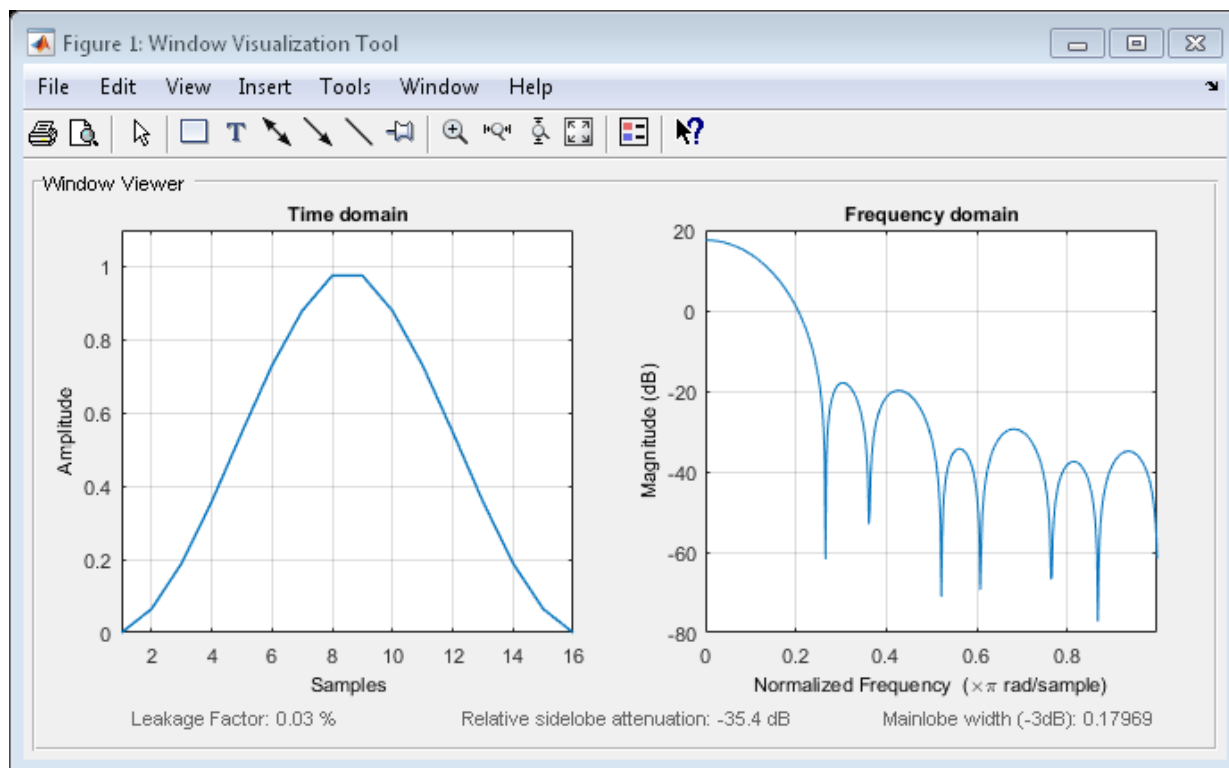

See Also

See Also

barthannwin | window | wvtool

sigwin.bartlett class

Package: sigwin

Construct Bartlett window object

Description

Note: The use of `sigwin.bartlett` is not recommended. Use `bartlett` instead.

`sigwin.bartlett` creates a handle to a Bartlett window object for use in spectral analysis and filtering by the window method. Object methods enable workspace import and ASCII file export of the window values.

For N even, the following equation defines the Bartlett window:

$$w(n) = \begin{cases} \frac{2n}{N-1} & 0 \leq n \leq N/2 - 1 \\ 2 - \frac{2n}{N-1} & N/2 \leq n \leq N-1 \end{cases}$$

For N odd, the equation for the Bartlett window is:

$$w(n) = \begin{cases} \frac{2n}{N-1} & 0 \leq n \leq (N-1)/2 \\ 2 - \frac{2n}{N-1} & (N-1)/2 + 1 \leq n \leq N-1 \end{cases}$$

Construction

`H = sigwin.bartlett` returns a Bartlett window object `H` of length 64.

`H = sigwin.bartlett(Length)` returns a Bartlett window object `H` of length *Length*. *Length* must be a positive integer. Entering a positive noninteger value for *Length* rounds the length to the nearest integer. Entering a 1 for *Length* results in a window with a single value of 1.

Properties

Length

Bartlett window length. The length requires a positive integer. Entering a positive noninteger value for *Length* rounds the length to the nearest integer. Entering a 1 for *Length* results in a window with a single value of 1.

Methods

generate	Generates Bartlett window
info	Display information about Bartlett window object
winwrite	Save Bartlett window object values in ASCII file

Copy Semantics

Handle. To learn how this affects your use of the class, see Copying Objects (MATLAB) in the MATLAB Programming Fundamentals documentation.

Examples

Bartlett Window

Generate a Bartlett window of length $N = 16$. Return its values as a column vector. Write the coefficients to an ASCII file in the current directory. Show information about the window object. Display the window.

```
H = sigwin.bartlett(16);
```

```
win = generate(H)
```

```
win =
```

```
    0  
  0.1333  
  0.2667
```

```
0.4000
0.5333
0.6667
0.8000
0.9333
0.9333
0.8000
```

```
winwrite(H, 'bartlett_16');
wininfo = info(H)
```

```
wininfo = 3×15 char array
    'Bartlett Window'
    '-----'
    'Length : 16'
```

```
wvtool(H)
```

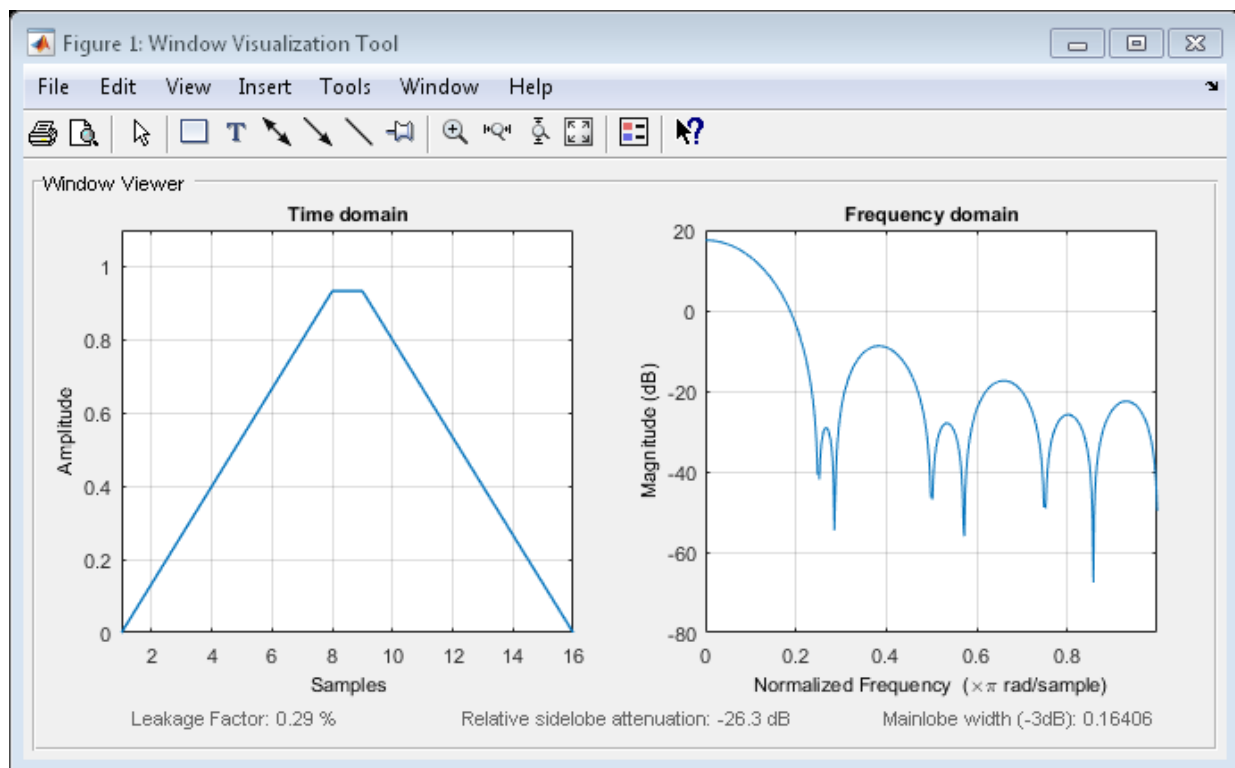

References

Oppenheim, Alan V., and Ronald W. Schaffer. *Discrete-Time Signal Processing*. Upper Saddle River, NJ: Prentice Hall, 1989.

See Also

See Also

bartlett | window | wvtool

Topics

“Windows”

Class Attributes (MATLAB)

Property Attributes (MATLAB)

generate

Class: sigwin.bartlett

Package: sigwin

Generates Bartlett window

Syntax

```
win = generate(H)
```

Description

`win = generate(H)` returns the values of the Bartlett window object `H` as a double-precision column vector.

Examples

Bartlett Window

Generate a Bartlett window of length $N = 16$. Return its values as a column vector. Write the coefficients to an ASCII file in the current directory. Show information about the window object. Display the window.

```
H = sigwin.bartlett(16);
```

```
win = generate(H)
```

```
win =
```

```
      0  
0.1333  
0.2667  
0.4000  
0.5333  
0.6667
```

```

0.8000
0.9333
0.9333
0.8000

```

```

winwrite(H, 'bartlett_16');
wininfo = info(H)

```

```

wininfo = 3x15 char array
    'Bartlett Window'
    '-----'
    'Length : 16   '

```

```

wvtool(H)

```

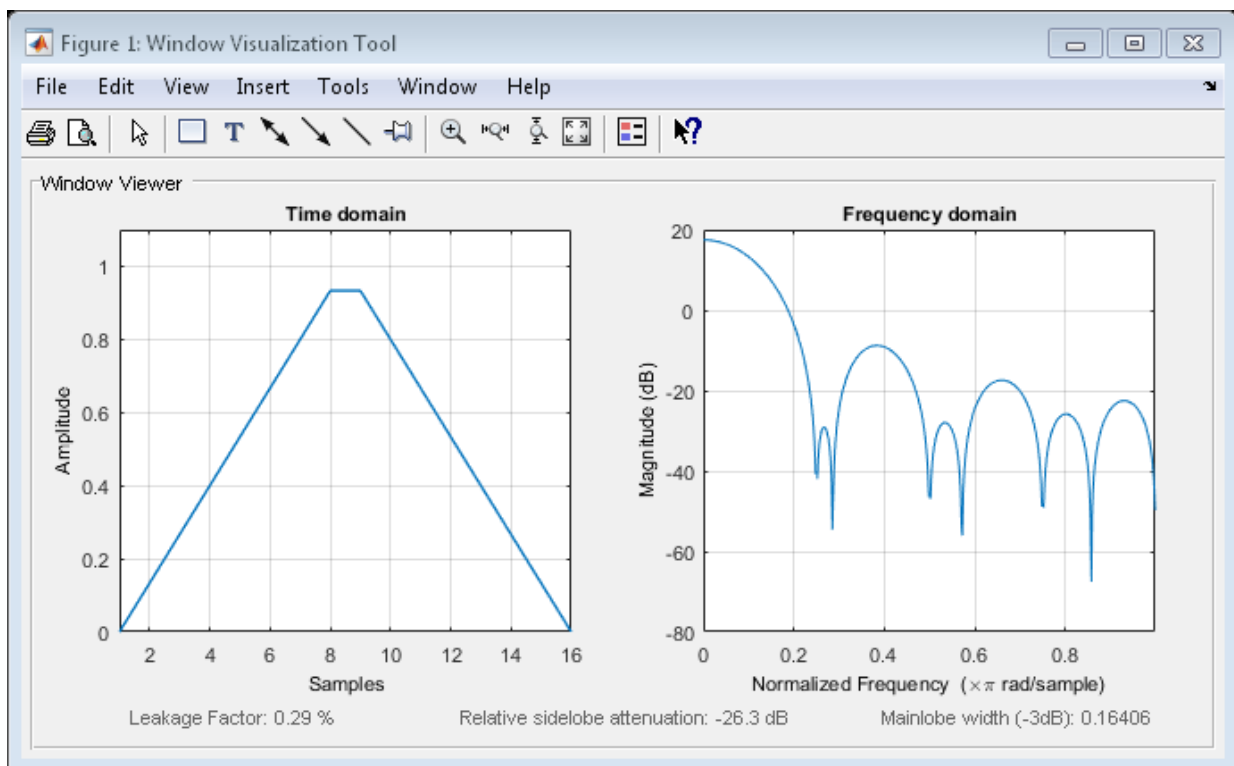

See Also

See Also

bartlett | window | wvtool

info

Class: sigwin.bartlett

Package: sigwin

Display information about Bartlett window object

Syntax

```
info(H)
info_win = info(H)
```

Description

`info(H)` displays length information for the Bartlett window object `H`.

`info_win = info(H)` returns length information for the Bartlett window object `H` in the character array `info_win`.

Examples

Bartlett Window

Generate a Bartlett window of length $N = 16$. Return its values as a column vector. Write the coefficients to an ASCII file in the current directory. Show information about the window object. Display the window.

```
H = sigwin.bartlett(16);
```

```
win = generate(H)
```

```
win =
```

```
      0
0.1333
0.2667
0.4000
0.5333
```

```
0.6667
0.8000
0.9333
0.9333
0.8000
```

```
winwrite(H, 'bartlett_16');
wininfo = info(H)
```

```
wininfo = 3×15 char array
    'Bartlett Window'
    '-----'
    'Length : 16'
```

```
wvtool(H)
```

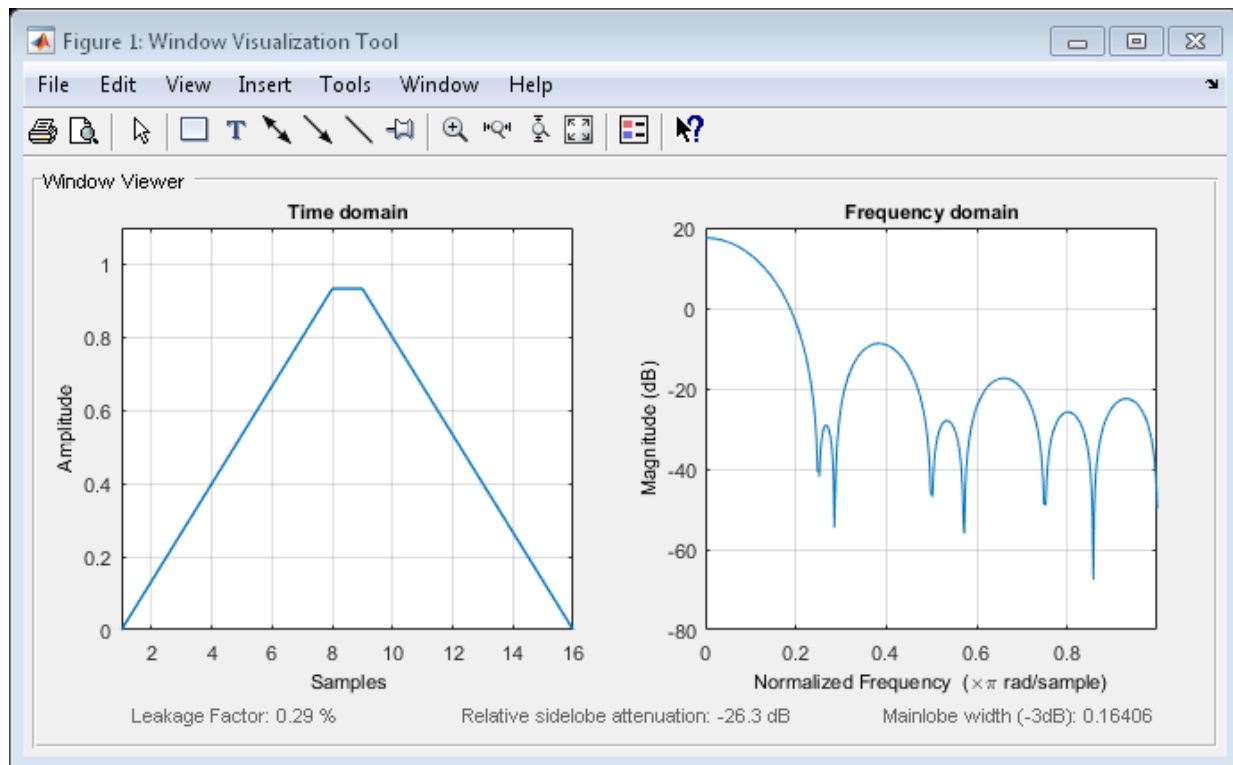

See Also

See Also

bartlett | window | wvtool

winwrite

Class: sigwin.bartlett

Package: sigwin

Save Bartlett window object values in ASCII file

Syntax

```
winwrite(H)
winwrite(H, 'filename')
```

Description

`winwrite(H)` opens a dialog box that enables you to export the values of the Bartlett window object `H` to an ASCII file with filename extension `wf`.

`winwrite(H, 'filename')` saves the values of the Bartlett window object `H` in the current folder as a column vector in the ASCII file `'filename'`. The filename extension is `wf`.

Examples

Bartlett Window

Generate a Bartlett window of length $N = 16$. Return its values as a column vector. Write the coefficients to an ASCII file in the current directory. Show information about the window object. Display the window.

```
H = sigwin.bartlett(16);
```

```
win = generate(H)
```

```
win =
```

```
          0
    0.1333
    0.2667
    0.4000
```

```

0.5333
0.6667
0.8000
0.9333
0.9333
0.8000

```

```

winwrite(H,'bartlett_16');
wininfo = info(H)

```

```

wininfo = 3x15 char array
'Bartlett Window'
'-----'
'Length : 16 '

```

```

wvtool(H)

```

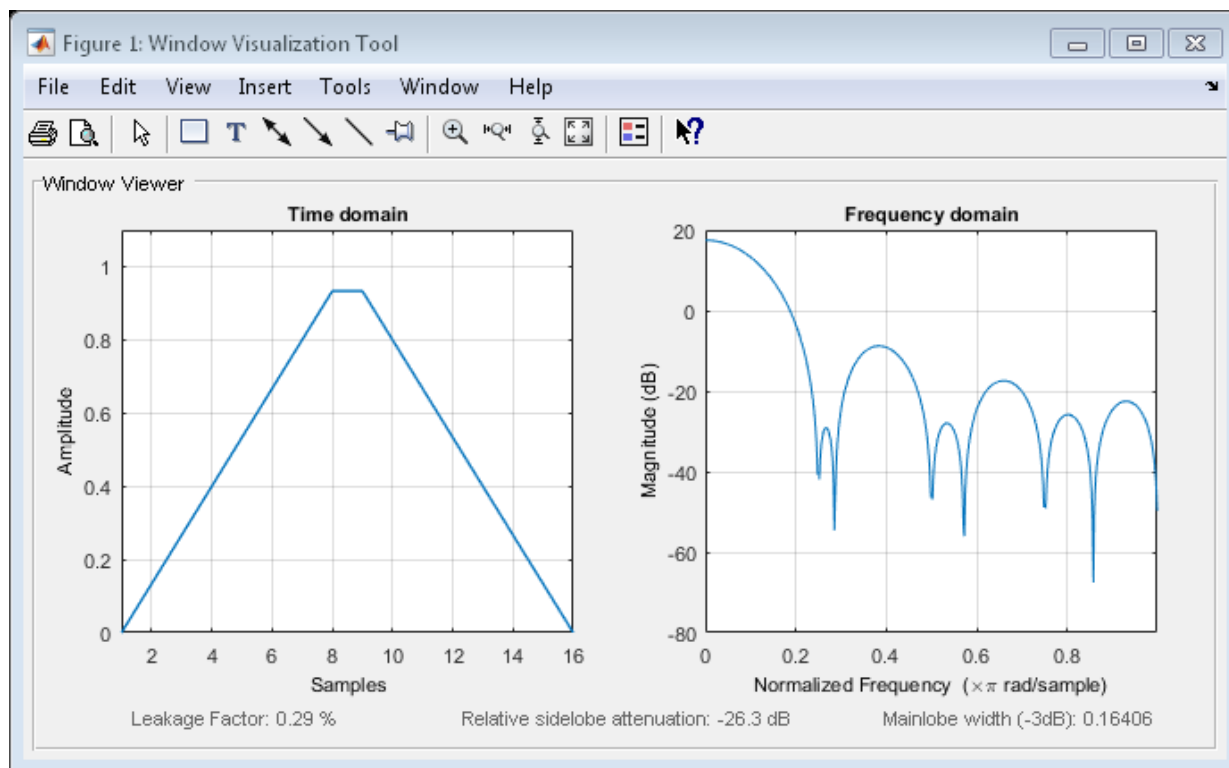

See Also

See Also

bartlett | window | wvtool

sigwin.blackman class

Package: sigwin

Construct Blackman window object

Description

Note: The use of `sigwin.blackman` is not recommended. Use `blackman` instead.

`sigwin.blackman` creates a handle to a Blackman window object for use in spectral analysis and FIR filtering by the window method. Object methods enable workspace import and ASCII file export of the window values.

The following equation defines the Blackman window of length N :

$$w(n) = 0.42 - 0.5 \cos \frac{2\pi n}{N-1} + 0.08 \cos \frac{4\pi n}{N-1}, \quad 0 \leq n \leq M-1$$

where M is $N/2$ for N even and $(N+1)/2$ for N odd.

In the symmetric case, the second half of the Blackman window $M \leq n \leq N-1$ is obtained by flipping the first half around the midpoint. The symmetric option is the preferred method when using a Blackman window in FIR filter design.

The periodic Blackman window is constructed by extending the desired window length by one sample to $N+1$, constructing a symmetric window, and removing the last sample. The periodic version is the preferred method when using a Blackman window in spectral analysis because the discrete Fourier transform assumes periodic extension of the input vector.

Construction

`H = sigwin.blackman` returns a Blackman window object `H` of length 64 with symmetric sampling.

`H = sigwin.blackman(Length)` returns a Blackman window object `H` of length *Length* with symmetric sampling. *Length* requires a positive integer. Entering a positive noninteger value for *Length* rounds the length to the nearest integer. Entering a 1 for *Length* results in a window with a single value of 1.

`H = sigwin.blackman(Length,SamplingFlag)` returns a Blackman window object `H` with sampling *SamplingFlag*. The *SamplingFlag* can be either 'symmetric' or 'periodic'.

Properties

Length

Blackman window length. Must be a positive integer. Entering a positive noninteger value for *Length* rounds the length to the nearest integer. Entering a 1 for *Length* results in a window with a single value of 1.

SamplingFlag

'symmetric' is the default and forces exact symmetry between the first and second halves of the Blackman window. A symmetric window is preferred in FIR filter design by the window method.

'periodic' designs a symmetric Blackman window of length *Length*+1 and truncates the window to length *Length*. This design is preferred in spectral analysis where the window is treated as one period of a *Length*-point periodic sequence.

Methods

<code>generate</code>	Generates Blackman window
<code>info</code>	Display information about Blackman window object
<code>winwrite</code>	Save Blackman window in ASCII file

Copy Semantics

Handle. To learn how this affects your use of the class, see Copying Objects (MATLAB) in the MATLAB Programming Fundamentals documentation.

Examples

Blackman Window

Generate a Blackman window of length $N = 16$. Return its values as a column vector. Write the coefficients to an ASCII file in the current directory. Show information about the window object. Display the window.

```
H = sigwin.blackman(16);  
  
win = generate(H)  
  
win =  
  
      0  
0.0168  
0.0771  
0.2008  
0.3940  
0.6300  
0.8492  
0.9822  
0.9822  
0.8492  
  
winwrite(H,'blackman_16');  
wininfo = info(H)  
  
wininfo = 4×26 char array  
    'Blackman Window      '  
    '-----            '  
    'Length           : 16 '  
    'Sampling Flag    : symmetric'
```

```
wvtool(H)
```

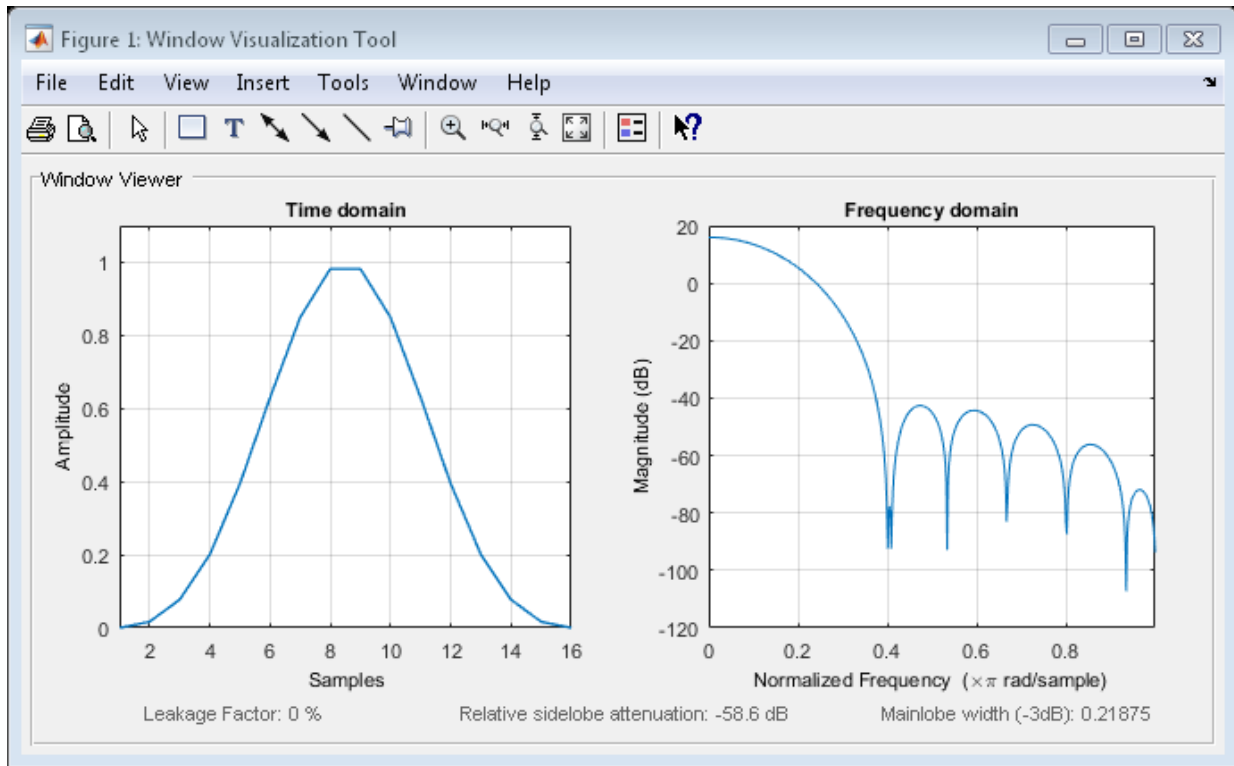

References

Oppenheim, Alan V., and Ronald W. Schaffer. *Discrete-Time Signal Processing*. Upper Saddle River, NJ: Prentice Hall, 1989.

See Also

See Also

blackman | window | wvtool

Topics

“Windows”

Class Attributes (MATLAB)

Property Attributes (MATLAB)

generate

Class: sigwin.blackman

Package: sigwin

Generates Blackman window

Syntax

```
win = generate(H)
```

Description

`win = generate(H)` returns the values of the Blackman window object `H` as a double-precision column vector.

Examples

Blackman Window

Generate a Blackman window of length $N = 16$. Return its values as a column vector. Write the coefficients to an ASCII file in the current directory. Show information about the window object. Display the window.

```
H = sigwin.blackman(16);
```

```
win = generate(H)
```

```
win =
```

```
      0  
0.0168  
0.0771  
0.2008  
0.3940  
0.6300  
0.8492
```

```
0.9822
0.9822
0.8492
```

```
winwrite(H, 'blackman_16');
wininfo = info(H)
```

```
wininfo = 4x26 char array
'Blackman Window'
'-----'
'Length      : 16'
'Sampling Flag : symmetric'
```

```
wvtool(H)
```

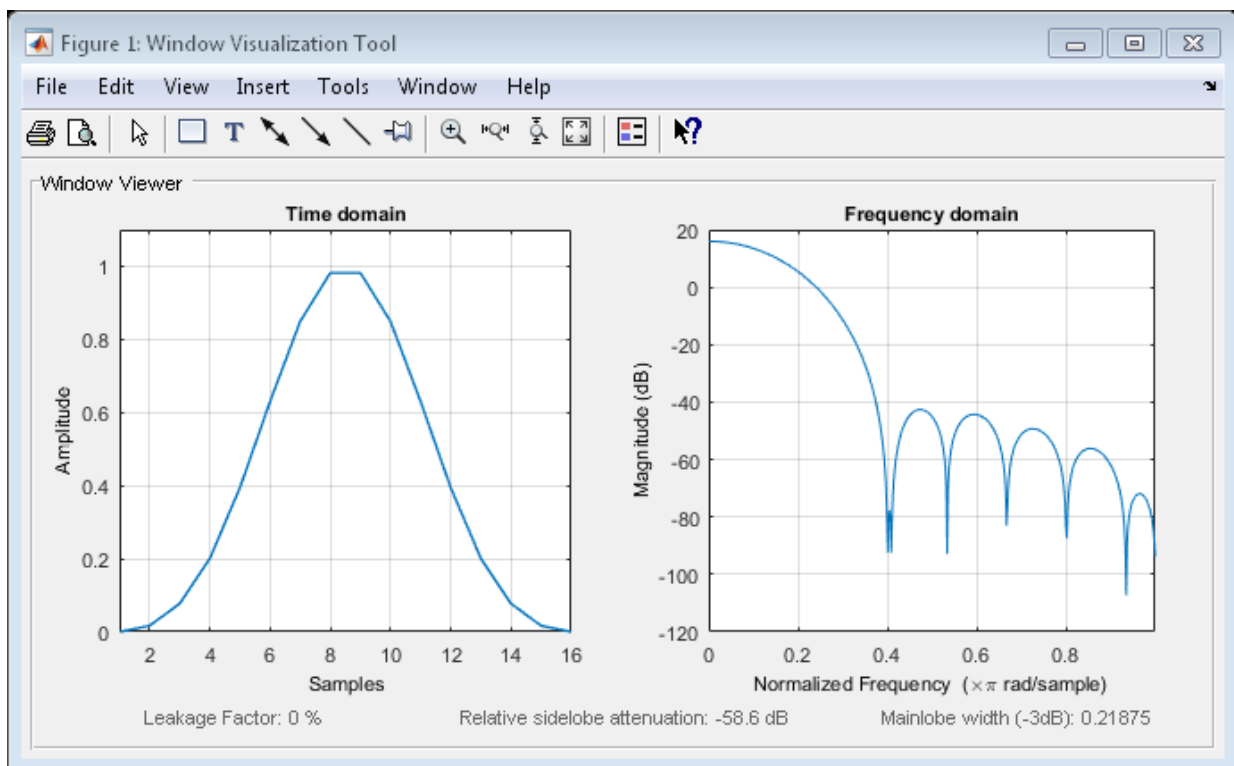

See Also

See Also

`blackman` | `window` | `wvtool`

info

Class: sigwin.blackman

Package: sigwin

Display information about Blackman window object

Syntax

```
info(H)
info_win = info(H)
```

Description

`info(H)` displays length and sampling information about the Blackman window object `H`.

`info_win = info(H)` returns length and sampling information about the Blackman window object `H` in the character array `info_win`.

Examples

Blackman Window

Generate a Blackman window of length $N = 16$. Return its values as a column vector. Write the coefficients to an ASCII file in the current directory. Show information about the window object. Display the window.

```
H = sigwin.blackman(16);
```

```
win = generate(H)
```

```
win =
```

```
      0
0.0168
0.0771
0.2008
0.3940
```

```
0.6300
0.8492
0.9822
0.9822
0.8492
```

```
winwrite(H,'blackman_16');
wininfo = info(H)
```

```
wininfo = 4x26 char array
    'Blackman Window'
    '-----'
    'Length          : 16'
    'Sampling Flag   : symmetric'
```

```
wvtool(H)
```

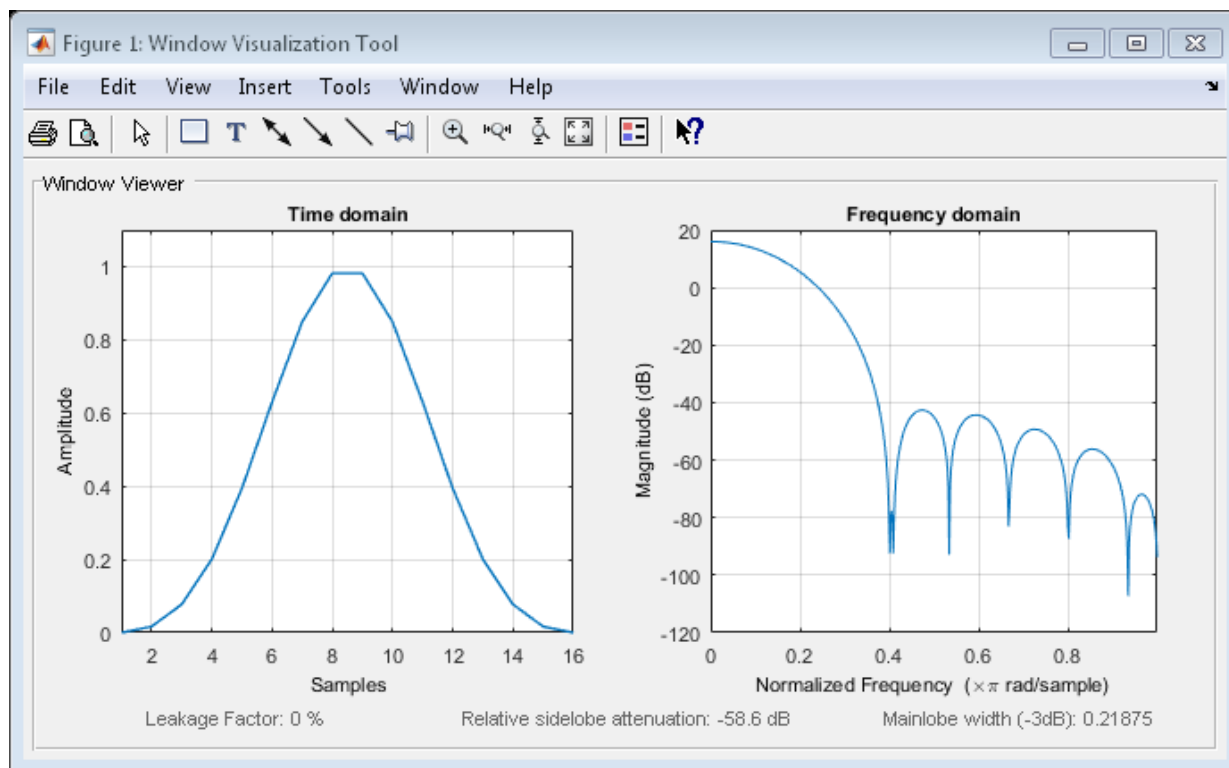

See Also

See Also

blackman | window | wvtool

winwrite

Class: sigwin.blackman

Package: sigwin

Save Blackman window in ASCII file

Syntax

```
winwrite(H)
winwrite(H, 'filename')
```

Description

`winwrite(H)` opens a dialog box that enables you to export the values of the Blackman window object `H` to an ASCII file with filename extension `wf` .

`winwrite(H, 'filename')` saves the values of the Blackman window object `H` in the current folder as a column vector in the ASCII file '`filename`' with filename extension `wf`.

Examples

Blackman Window

Generate a Blackman window of length $N = 16$. Return its values as a column vector. Write the coefficients to an ASCII file in the current directory. Show information about the window object. Display the window.

```
H = sigwin.blackman(16);
```

```
win = generate(H)
```

```
win =
```

```
      0
0.0168
0.0771
0.2008
```



```

0.3940
0.6300
0.8492
0.9822
0.9822
0.8492

```

```

winwrite(H, 'blackman_16');
wininfo = info(H)

```

```

wininfo = 4x26 char array
    'Blackman Window'
    '-----'
    'Length          : 16'
    'Sampling Flag   : symmetric'

```

```

wvtool(H)

```

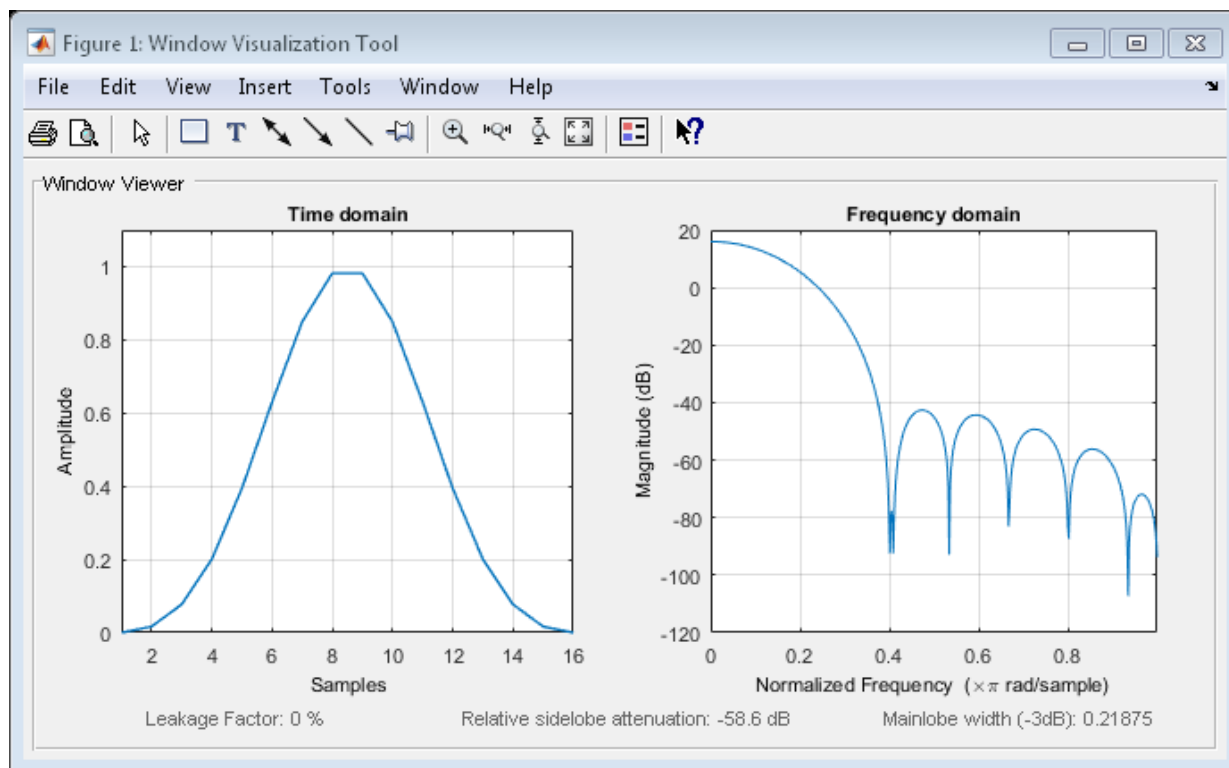

See Also

See Also

`blackman` | `window` | `wvtool`

sigwin.blackmanharris class

Package: sigwin

Construct Blackman-Harris window object

Description

Note: The use of sigwin.blackmanharris is not recommended. Use blackmanharris instead.

sigwin.blackmanharris creates a handle to a Blackman-Harris window object for use in spectral analysis and FIR filtering by the window method. Object methods enable workspace import and ASCII file export of the window values.

The following equation defines the **symmetric** Blackman-Harris window of length N :

$$w(n) = a_0 - a_1 \cos\left(\frac{2\pi n}{N-1}\right) + a_2 \cos\left(\frac{4\pi n}{N-1}\right) - a_3 \cos\left(\frac{6\pi n}{N-1}\right), \quad 0 \leq n \leq N-1$$

The following equation defines the **periodic** Blackman-Harris window of length N :

$$w(n) = a_0 - a_1 \cos\frac{2\pi n}{N} + a_2 \cos\frac{4\pi n}{N} - a_3 \cos\frac{6\pi n}{N}, \quad 0 \leq n \leq N-1$$

The following table lists the coefficients:

Coefficient	Value
a_0	0.35875
a_1	0.48829
a_2	0.14128
a_3	0.01168

Construction

`H = sigwin.blackmanharris` returns a Blackman-Harris window object `H` of length 64.

`H = sigwin.blackmanharris(Length)` returns a Blackman-Harris window object `H` of length `Length`. `Length` must be a positive integer. Entering a positive noninteger value for `Length` rounds the length to the nearest integer. Entering a 1 for `Length` results in a window with a single value of 1.

Properties

Length

Blackman-Harris window length. The window length requires a positive integer. Entering a positive noninteger value for `Length` rounds the length to the nearest integer. Entering a 1 for `Length` results in a window with a single value of 1.

SamplingFlag

The type of window returned as one of `'symmetric'` or `'periodic'`. The default is `'symmetric'`. A symmetric window exhibits perfect symmetry between halves of the window. Setting the `SamplingFlag` property to `'periodic'` results in a N-periodic window. The equations for the Blackman-Harris window differ slightly based on the value of the `SamplingFlag` property. See “Description” on page 1-1901 for details.

Methods

<code>generate</code>	Generates Blackman–Harris window
<code>info</code>	Display information about Blackman–Harris window object
<code>winwrite</code>	Save Blackman–Harris window in ASCII file

Copy Semantics

Handle. To learn how copy semantics affect your use of the class, see Copying Objects (MATLAB) in the MATLAB Programming Fundamentals documentation.

Examples

Blackman-Harris Window

Generate a Blackman-Harris window of length $N = 16$. Return its values as a column vector. Write the coefficients to an ASCII file in the current directory. Show information about the window object. Display the window.

```
H = sigwin.blackmanharris(16);  
  
win = generate(H)  
  
win =  
  
    0.0001  
    0.0036  
    0.0267  
    0.1030  
    0.2680  
    0.5206  
    0.7938  
    0.9749  
    0.9749  
    0.7938  
  
winwrite(H,'blackmanharris_16');  
wininfo = info(H)  
  
wininfo = 4×26 char array  
    'Blackman-Harris Window'  
    '-----'  
    'Length           : 16'  
    'Sampling Flag   : symmetric'  
  
wvtool(H)
```

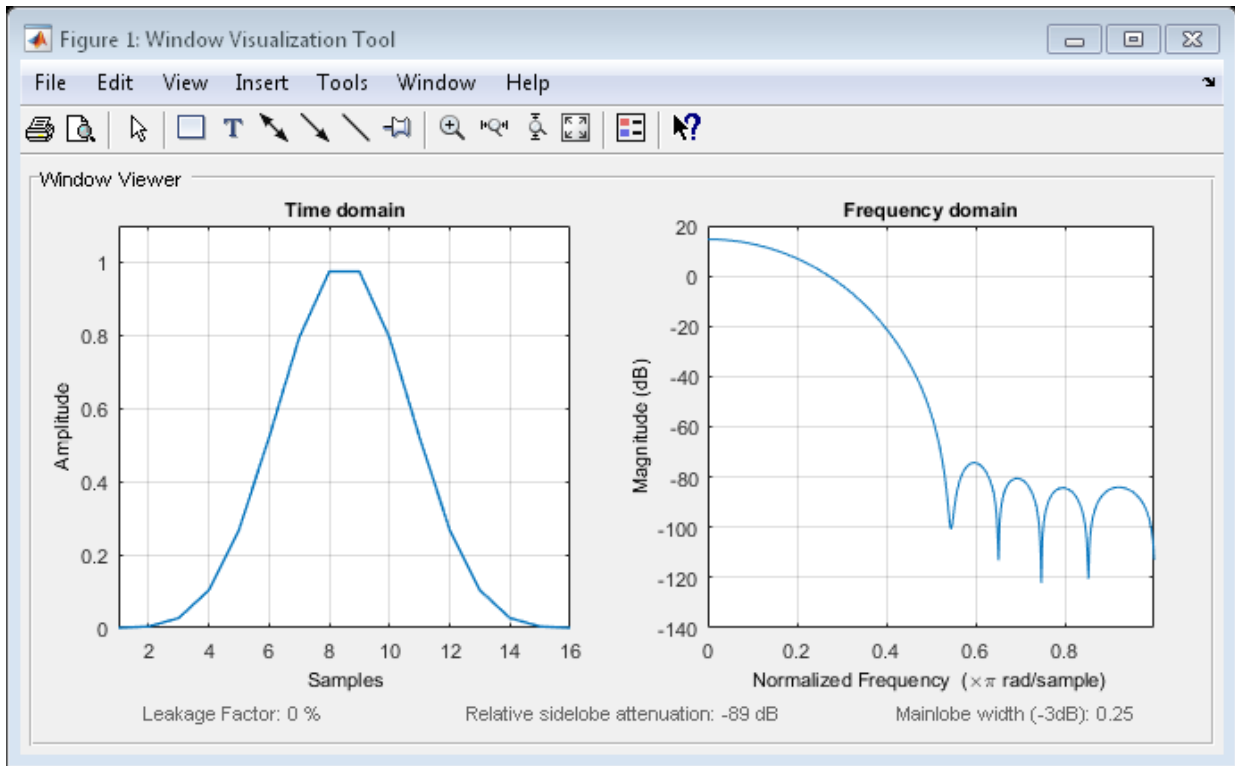

References

harris, fredric j. "On the Use of Windows for Harmonic Analysis with the Discrete Fourier Transform." *Proceedings of the IEEE*. Vol. 66, January 1978, pp. 51–83.

See Also

See Also

blackmanharris | window | wvtool

Topics

“Windows”

Class Attributes (MATLAB)

Property Attributes (MATLAB)

generate

Class: sigwin.blackmanharris

Package: sigwin

Generates Blackman–Harris window

Syntax

```
win = generate(H)
```

Description

`win = generate(H)` returns the values of the Blackman–Harris window object `H` as a double-precision column vector.

Examples

Blackman-Harris Window

Generate a Blackman-Harris window of length $N = 16$. Return its values as a column vector. Write the coefficients to an ASCII file in the current directory. Show information about the window object. Display the window.

```
H = sigwin.blackmanharris(16);
```

```
win = generate(H)
```

```
win =
```

```
0.0001  
0.0036  
0.0267  
0.1030  
0.2680  
0.5206  
0.7938
```



```
0.9749
0.9749
0.7938
```

```
winwrite(H, 'blackmanharris_16');
wininfo = info(H)
```

```
wininfo = 4x26 char array
    'Blackman-Harris Window'
    '-----'
    'Length           : 16'
    'Sampling Flag    : symmetric'
```

```
wvtool(H)
```

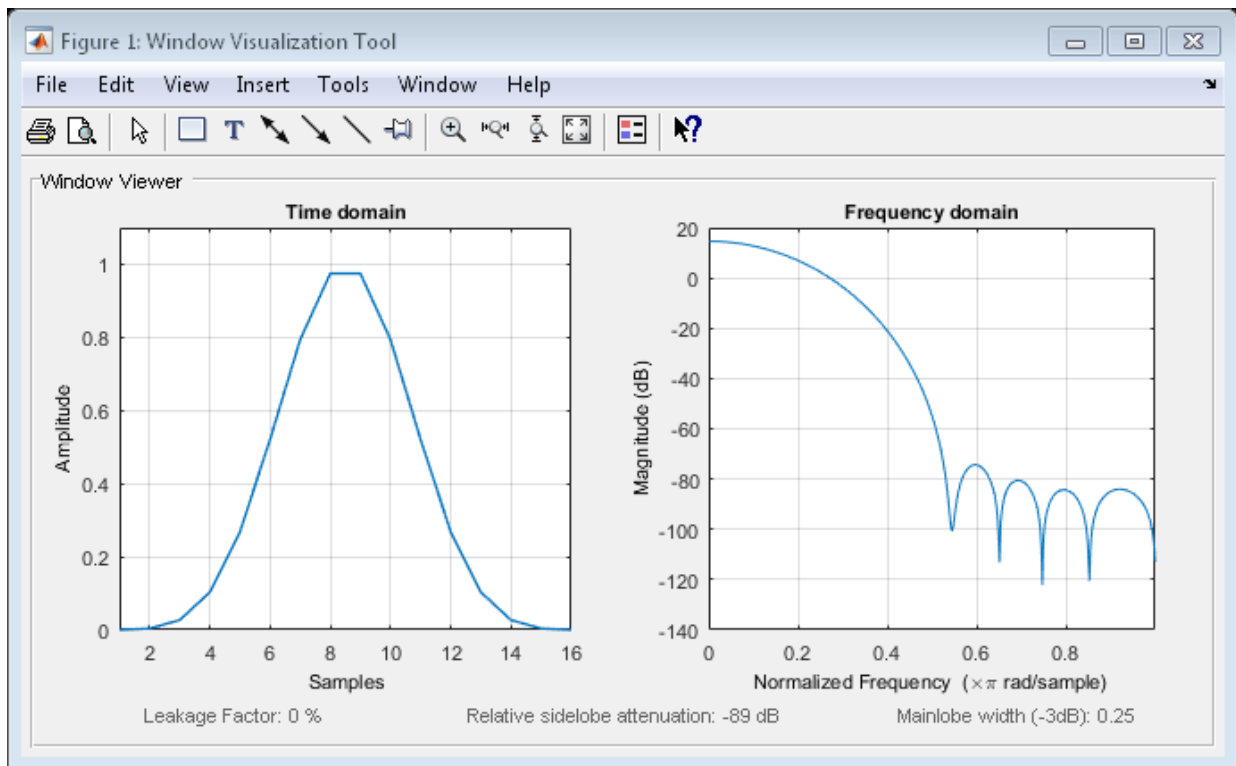

See Also

See Also

`blackmanharris` | `window` | `wvtool`

info

Class: sigwin.blackmanharris

Package: sigwin

Display information about Blackman–Harris window object

Syntax

```
info(H)
info_win = info(H)
```

Description

`info(H)` displays length information for the Blackman–Harris window object `H`.

`info_win = info(H)` returns length information for the Blackman–Harris window object `H` in the character array `info_win`.

Examples

Blackman-Harris Window

Generate a Blackman-Harris window of length $N = 16$. Return its values as a column vector. Write the coefficients to an ASCII file in the current directory. Show information about the window object. Display the window.

```
H = sigwin.blackmanharris(16);
```

```
win = generate(H)
```

```
win =
```

```
0.0001
0.0036
0.0267
0.1030
0.2680
```

```
0.5206
0.7938
0.9749
0.9749
0.7938
```

```
winwrite(H,'blackmanharris_16');
wininfo = info(H)
```

```
wininfo = 4x26 char array
'Blackman-Harris Window'
'-----'
'Length      : 16'
'Sampling Flag : symmetric'
```

```
wvtool(H)
```

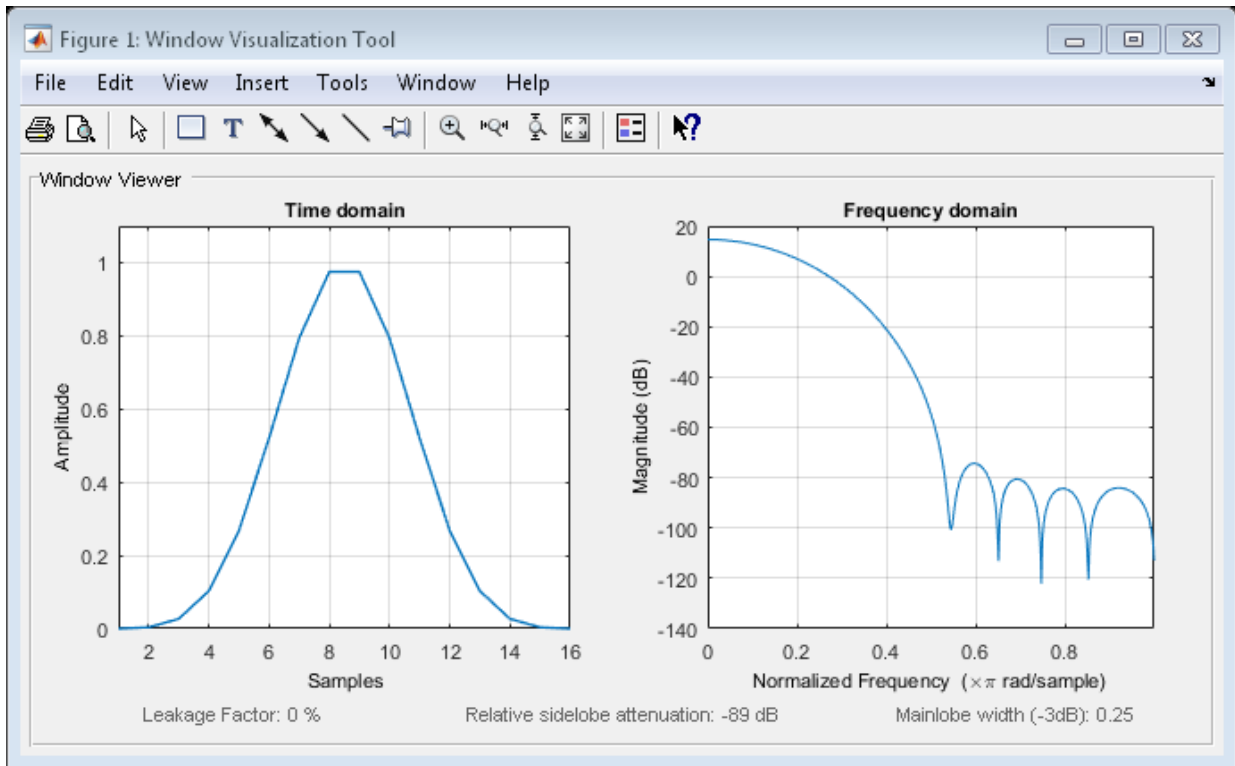

See Also

See Also

blackmanharris | window | wvtool

winwrite

Class: sigwin.blackmanharris

Package: sigwin

Save Blackman–Harris window in ASCII file

Syntax

```
winwrite(H)
winwrite(H, 'filename')
```

Description

`winwrite(H)` opens a dialog box that enables you to export the values of the Blackman–Harris window object `H` to an ASCII file with filename extension `wf`.

`winwrite(H, 'filename')` saves the values of the Blackman–Harris window object `H` in the current folder as a column vector in the ASCII file `'filename'` with filename extension `wf`.

Examples

Blackman-Harris Window

Generate a Blackman-Harris window of length $N = 16$. Return its values as a column vector. Write the coefficients to an ASCII file in the current directory. Show information about the window object. Display the window.

```
H = sigwin.blackmanharris(16);
```

```
win = generate(H)
```

```
win =
```

```
0.0001
0.0036
0.0267
0.1030
```

```

0.2680
0.5206
0.7938
0.9749
0.9749
0.7938

```

```

winwrite(H, 'blackmanharris_16');
wininfo = info(H)

```

```

wininfo = 4x26 char array
    'Blackman-Harris Window'
    '-----'
    'Length          : 16'
    'Sampling Flag   : symmetric'

```

```

wvtool(H)

```

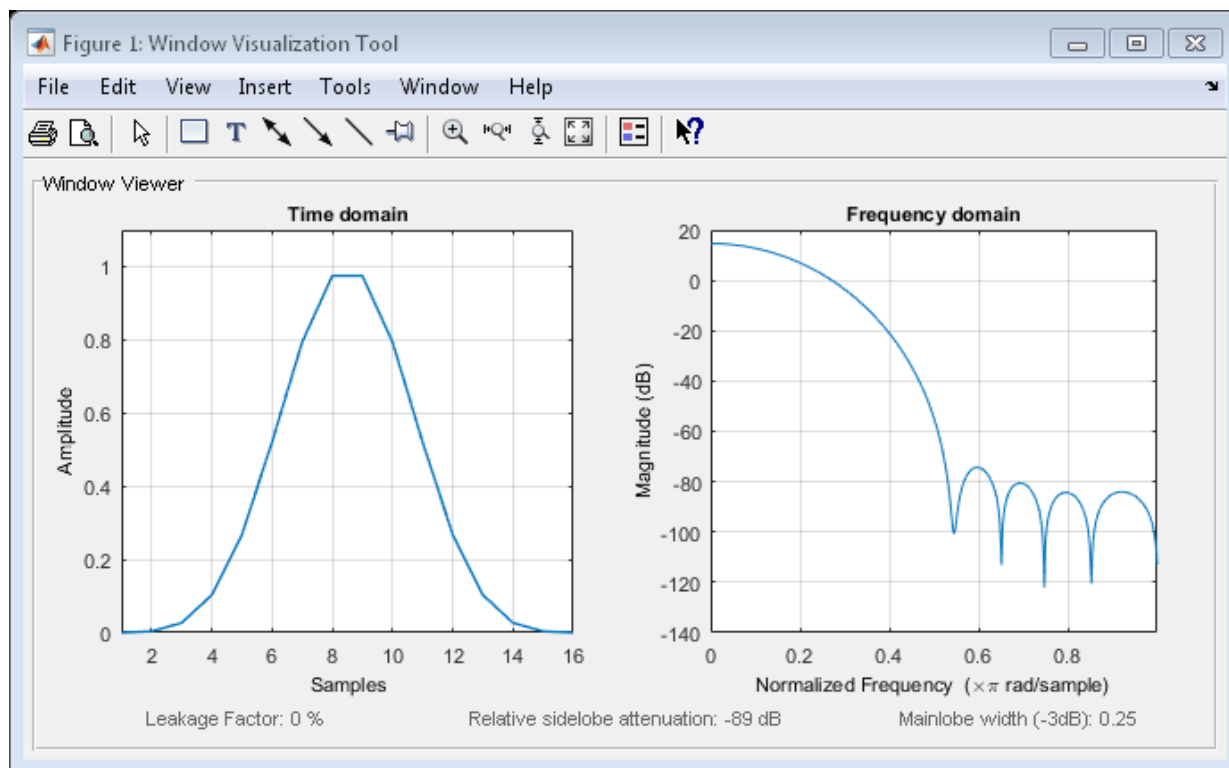

See Also

See Also

`blackmanharris` | `window` | `wvtool`

sigwin.bohmanwin class

Package: sigwin

Construct Bohman window object

Description

Note: The use of `sigwin.bohmanwin` is not recommended. Use `bohmanwin` instead.

`sigwin.bohmanwin` creates a handle to a Bohman window object for use in spectral analysis and FIR filtering by the window method. Object methods enable workspace import and ASCII file export of the window values.

The following equation defines the Bohman window of length N :

$$w(x) = (1 - |x|) \cos(\pi |x|) + \frac{1}{\pi} \sin(\pi |x|), \quad -1 \leq x \leq 1$$

where x is a length N vector of linearly spaced values generated using `linspace`. The first and last elements of the Bohman window are forced to be identically zero.

Construction

`H = sigwin.bohmanwin` returns a Bohman window object `H` of length 64.

`H = sigwin.bohmanwin(Length)` returns a Bohman window object `H` of length *Length*. *Length* is a positive integer. Entering a positive noninteger value for *Length* rounds the length to the nearest integer. Entering a 1 for *Length* results in a window with a single value of 1.

Properties

Length

Bohman window length. Must be a positive integer. Entering a positive noninteger value for *Length* rounds the length to the nearest integer. Entering a 1 for *Length* results in a window with a single value of 1.

Methods

generate	Generates Bohman window
info	Display information about Bohman window object
winwrite	Save Bohman window object values in ASCII file

Copy Semantics

Handle. To learn how copy semantics affect your use of the class, see Copying Objects (MATLAB) in the MATLAB Programming Fundamentals documentation.

Examples

Bohman Window

Generate a Bohman window of length $N = 16$. Return its values as a column vector. Write the coefficients to an ASCII file in the current directory. Show information about the window object. Display the window.

```
H = sigwin.bohmanwin(16);
```

```
win = generate(H)
```

```
win =
```

```
      0  
 0.0077  
 0.0581
```

```

0.1791
0.3723
0.6090
0.8343
0.9791
0.9791
0.8343

```

```

winwrite(H, 'bohmanwin_16');
wininfo = info(H)

```

```

wininfo = 3×13 char array
    'Bohman Window'
    '-----'
    'Length : 16 '

```

```

wvtool(H)

```

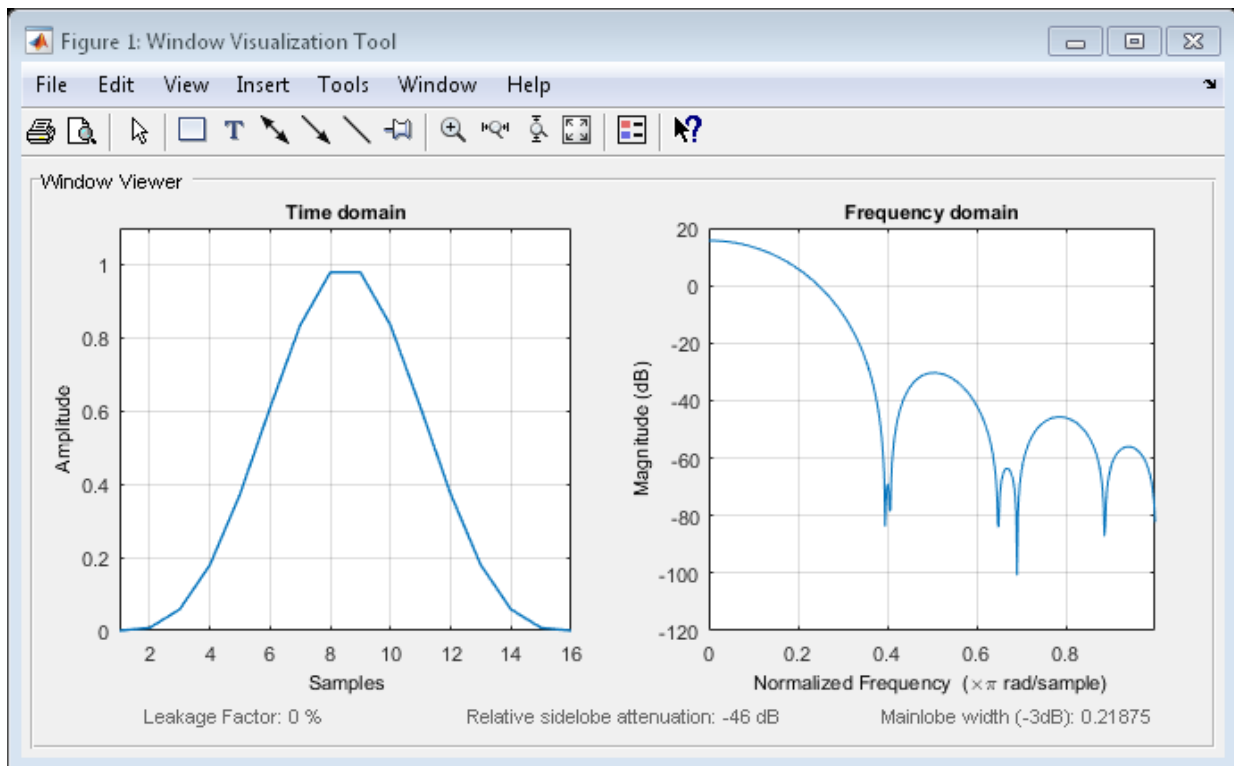

References

harris, fredric j. “On the Use of Windows for Harmonic Analysis with the Discrete Fourier Transform.” *Proceedings of the IEEE*. Vol. 66, January 1978, pp. 51–83.

See Also

See Also

bohmanwin | window | wvtool

Topics

“Windows”

Class Attributes (MATLAB)

Property Attributes (MATLAB)

generate

Class: sigwin.bohmanwin

Package: sigwin

Generates Bohman window

Syntax

```
win = generate(H)
```

Description

`win = generate(H)` returns the values of the Bohman window object as a double-precision column vector.

Examples

Bohman Window

Generate a Bohman window of length $N = 16$. Return its values as a column vector. Write the coefficients to an ASCII file in the current directory. Show information about the window object. Display the window.

```
H = sigwin.bohmanwin(16);
```

```
win = generate(H)
```

```
win =
```

```
      0  
0.0077  
0.0581  
0.1791  
0.3723  
0.6090
```

```
0.8343
0.9791
0.9791
0.8343
```

```
winwrite(H, 'bohmanwin_16');
wininfo = info(H)
```

```
wininfo = 3×13 char array
    'Bohman Window'
    '-----'
    'Length   : 16 '
```

```
wvtool(H)
```

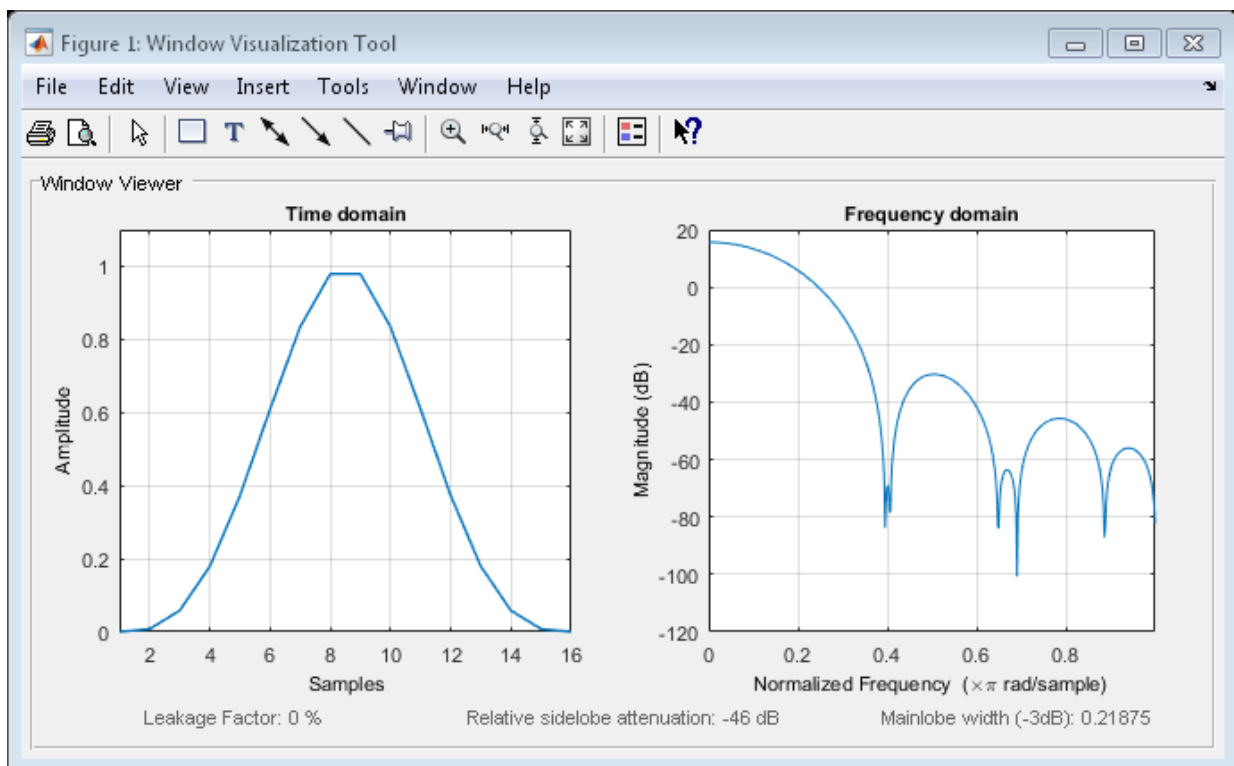

See Also

See Also

bohmanwin | window | wvtool

Topics

“Windows”

Class Attributes (MATLAB)

Property Attributes (MATLAB)

info

Class: sigwin.bohmanwin

Package: sigwin

Display information about Bohman window object

Syntax

```
info(H)
info_win = info(H)
```

Description

`info(H)` displays length information for the Bohman window object `H`.

`info_win = info(H)` returns length information for the Bohman window object `H` in the character array `info_win`.

Examples

Bohman Window

Generate a Bohman window of length $N = 16$. Return its values as a column vector. Write the coefficients to an ASCII file in the current directory. Show information about the window object. Display the window.

```
H = sigwin.bohmanwin(16);
```

```
win = generate(H)
```

```
win =
```

```
      0
0.0077
0.0581
0.1791
0.3723
```



```

0.6090
0.8343
0.9791
0.9791
0.8343

```

```

winwrite(H,'bohmanwin_16');
wininfo = info(H)

```

```

wininfo = 3×13 char array
    'Bohman Window'
    '-----'
    'Length : 16 '

```

```

wvtool(H)

```

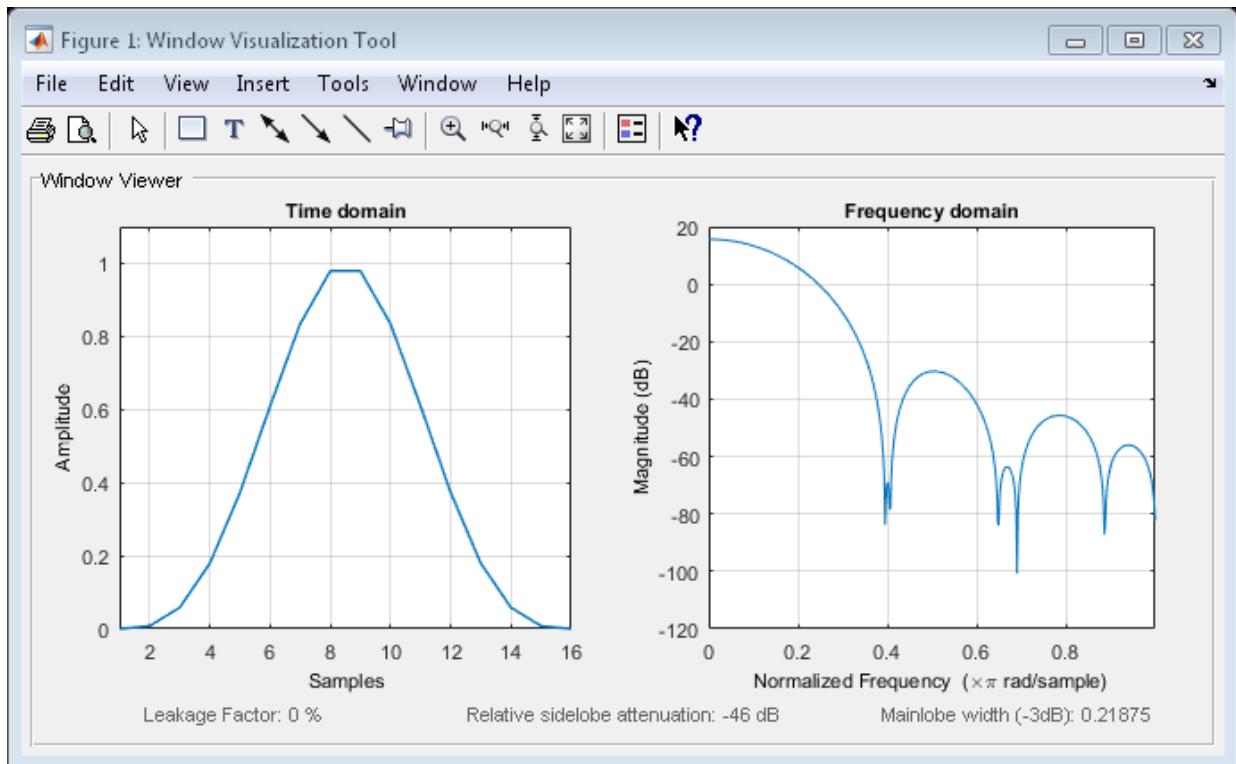

See Also

See Also

bohmanwin | window | wvtool

Topics

“Windows”

Class Attributes (MATLAB)

Property Attributes (MATLAB)

winwrite

Class: sigwin.bohmanwin

Package: sigwin

Save Bohman window object values in ASCII file

Syntax

```
winwrite(H)
winwrite(H, 'filename')
```

Description

`winwrite(H)` opens a dialog to export the values of the Bohman window object `H` to an ASCII file. The file extension `.wf` is automatically appended.

`winwrite(H, 'filename')` saves the values of the Bohman window object `H` in the current folder as a column vector in the ASCII file `'filename'`. The file extension `.wf` is automatically appended to `filename`.

Examples

Bohman Window

Generate a Bohman window of length $N = 16$. Return its values as a column vector. Write the coefficients to an ASCII file in the current directory. Show information about the window object. Display the window.

```
H = sigwin.bohmanwin(16);
```

```
win = generate(H)
```

```
win =
```

```
      0
0.0077
0.0581
0.1791
```

```
0.3723
0.6090
0.8343
0.9791
0.9791
0.8343
```

```
winwrite(H,'bohmanwin_16');
wininfo = info(H)
```

```
wininfo = 3×13 char array
'Bohman Window'
'-----'
'Length : 16 '
```

```
wvtool(H)
```

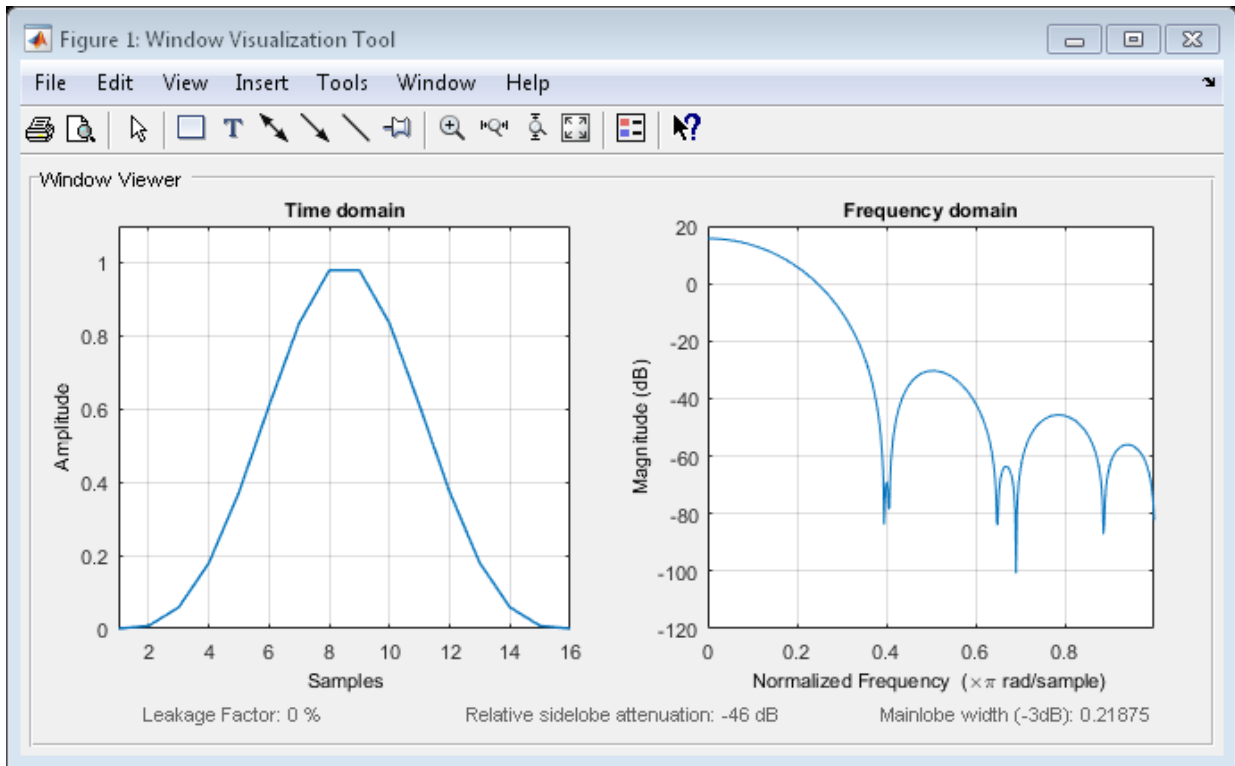

See Also

See Also

bohmanwin | window | wvtool

Topics

“Windows”

Class Attributes (MATLAB)

Property Attributes (MATLAB)

sigwin.chebwin class

Package: sigwin

Construct Dolph-Chebyshev window object

Description

Note: The use of `sigwin.chebwin` is not recommended. Use `chebwin` instead.

`sigwin.chebwin` creates a handle to a Dolph-Chebyshev window object for use in spectral analysis and FIR filtering by the window method. Object methods enable workspace import and ASCII file export of the window values.

The Dolph-Chebyshev window is constructed in the frequency domain by taking samples of the window's Fourier transform:

$$\hat{W}(k) = (-1)^k \frac{\cos[N \cos^{-1}[\beta \cos(\pi k / N)]]}{\cosh[N \cosh^{-1}(\beta)]}, \quad 0 \leq k \leq N - 1$$

where

$$\beta = \cos[1 / N \cosh^{-1}(10^\alpha)]$$

α determines the level of the sidelobe attenuation. The level of the sidelobe attenuation is equal to -20α . For example, 100 dB of attenuation results from setting $\alpha = 5$

The discrete-time Dolph-Chebyshev window is obtained by taking the inverse DFT of $\hat{W}(k)$ and scaling the result to have a peak value of 1.

Construction

`H = sigwin.chebwin` returns a Dolph-Chebyshev window object `H` of length 64 with relative sidelobe attenuation of 100 dB.

`H = sigwin.chebwin(Length)` returns a Dolph-Chebyshev window object `H` of length *Length* with relative sidelobe attenuation of 100 dB. *Length* requires a positive integer. Entering a positive noninteger value for *Length* rounds the length to the nearest integer. A window length of 1 results in a window with a single value equal to 1.

`H = sigwin.chebwin(Length,SidelobeAtten)` returns a Dolph-Chebyshev window object with relative sidelobe attenuation of *atten_param* dB.

Properties

Length

Dolph-Chebyshev window length.

SidelobeAtten

The attenuation parameter in dB. The attenuation parameter is a positive real number that determines the relative sidelobe attenuation of the window.

Methods

<code>generate</code>	Generates Dolph-Chebyshev window
<code>info</code>	Display information about Dolph-Chebyshev window object
<code>winwrite</code>	Save Dolph-Chebyshev window object values in ASCII file

Copy Semantics

Handle. To learn how copy semantics affect your use of the class, see Copying Objects (MATLAB) in the MATLAB Programming Fundamentals documentation.

Examples

Dolph-Chebyshev Window

Generate a Dolph-Chebyshev window of length $N = 16$. Specify a relative sidelobe attenuation of 40 dB. Return the window values as a column vector. Write the coefficients to an ASCII file in the current directory. Show information about the window object. Display the window.

```
H = sigwin.chebwin(16,40);
```

```
win = generate(H)
```

```
win =
```

```
0.1138  
0.1964  
0.3319  
0.4926  
0.6613  
0.8163  
0.9353  
1.0000  
1.0000  
0.9353
```

```
winwrite(H,'chebwin_16_40');
```

```
wininfo = info(H)
```

```
wininfo = 4×26 char array  
    'Chebyshev Window          '  
    '-----'                '  
    'Length                    : 16'  
    'Sidelobe Attenuation      : 40'
```

```
wvtool(H)
```

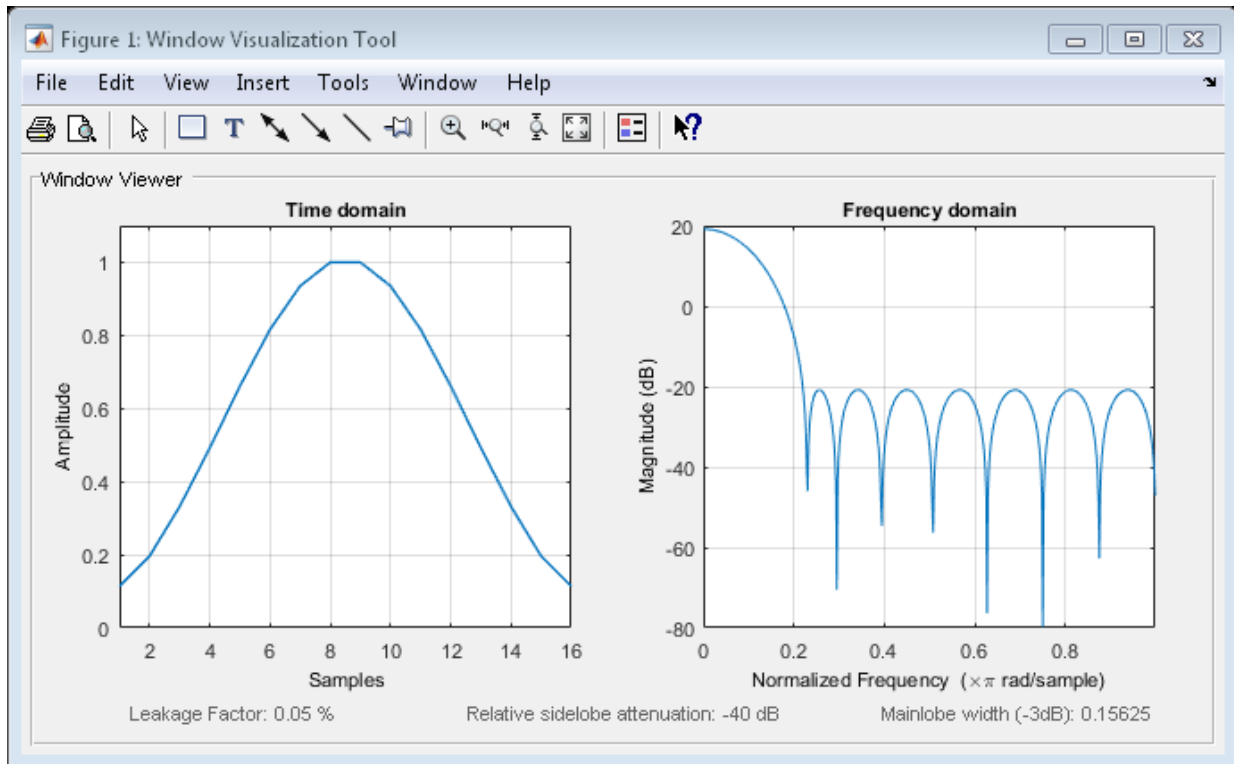
References

harris, fredric j. "On the Use of Windows for Harmonic Analysis with the Discrete Fourier Transform." *Proceedings of the IEEE*. Vol. 66, January 1978, pp. 51–83.

See Also

See Also

chebwin | window | wvtool

Topics

“Windows”

Class Attributes (MATLAB)

Property Attributes (MATLAB)

generate

Class: sigwin.chebwin

Package: sigwin

Generates Dolph-Chebyshev window

Syntax

```
win = generate(H)
```

Description

`win = generate(H)` returns the values of the Dolph-Chebyshev window object `H` as a double-precision column vector.

Examples

Dolph-Chebyshev Window

Generate a Dolph-Chebyshev window of length $N = 16$. Specify a relative sidelobe attenuation of 40 dB. Return the window values as a column vector. Write the coefficients to an ASCII file in the current directory. Show information about the window object. Display the window.

```
H = sigwin.chebwin(16,40);
```

```
win = generate(H)
```

```
win =
```

```
0.1138  
0.1964  
0.3319  
0.4926  
0.6613  
0.8163
```

```
0.9353
1.0000
1.0000
0.9353
```

```
winwrite(H, 'chebwin_16_40');
wininfo = info(H)
```

```
wininfo = 4x26 char array
    'Chebyshev Window          '
    '-----'
    'Length                    : 16'
    'Sidelobe Attenuation      : 40'
```

```
wvtool(H)
```

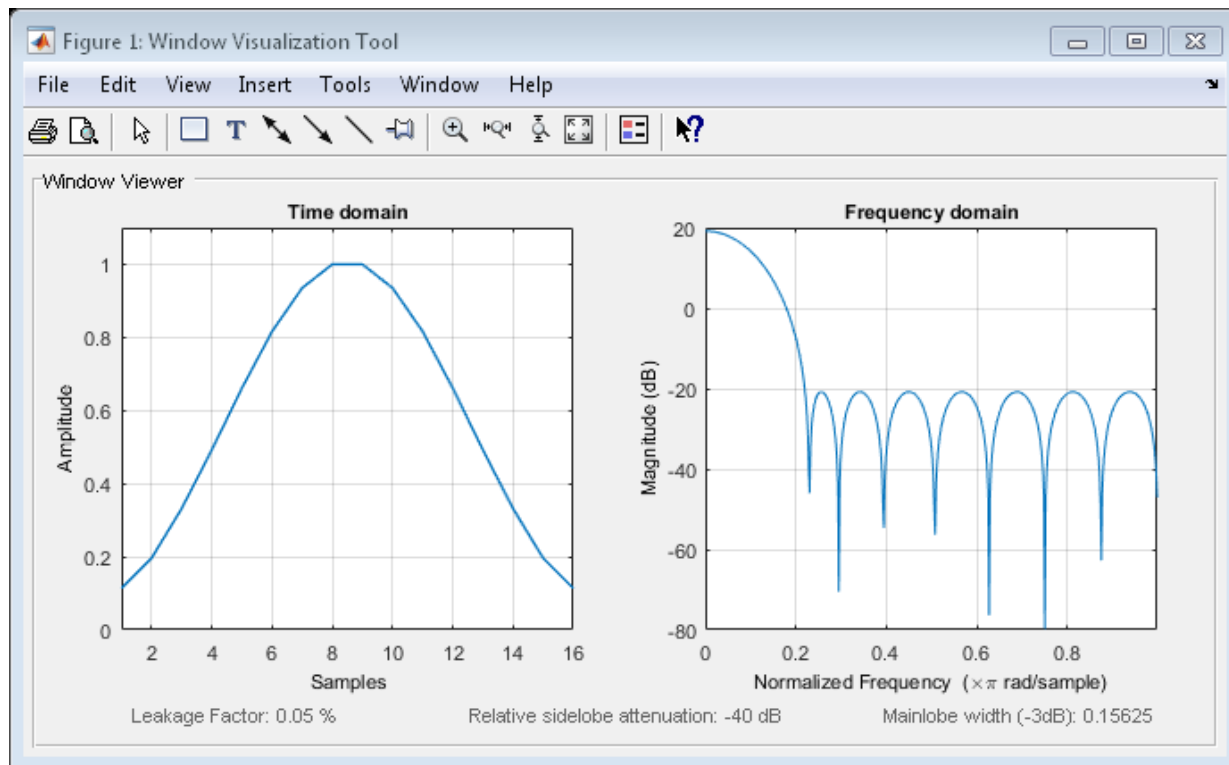

See Also

See Also

[chebwin](#) | [window](#) | [wvtool](#)

Topics

[“Windows”](#)

[Class Attributes \(MATLAB\)](#)

[Property Attributes \(MATLAB\)](#)

info

Class: sigwin.chebwin

Package: sigwin

Display information about Dolph–Chebyshev window object

Syntax

```
info(H)
info_win = info(H)
```

Description

`info(H)` displays length and relative sidelobe attenuation information for the Dolph-Chebyshev window object `H`.

`info_win = info(H)` returns length information for the Dolph-Chebyshev window object `H` in the character array `info_win`.

Examples

Dolph-Chebyshev Window

Generate a Dolph-Chebyshev window of length $N = 16$. Specify a relative sidelobe attenuation of 40 dB. Return the window values as a column vector. Write the coefficients to an ASCII file in the current directory. Show information about the window object. Display the window.

```
H = sigwin.chebwin(16,40);
```

```
win = generate(H)
```

```
win =
```

```
    0.1138
    0.1964
    0.3319
    0.4926
```

```

0.6613
0.8163
0.9353
1.0000
1.0000
0.9353

```

```

winwrite(H, 'chebwin_16_40');
wininfo = info(H)

```

```

wininfo = 4x26 char array
    'Chebyshev Window          '
    '-----'
    'Length                   : 16'
    'Sidelobe Attenuation     : 40'

```

```

wvtool(H)

```

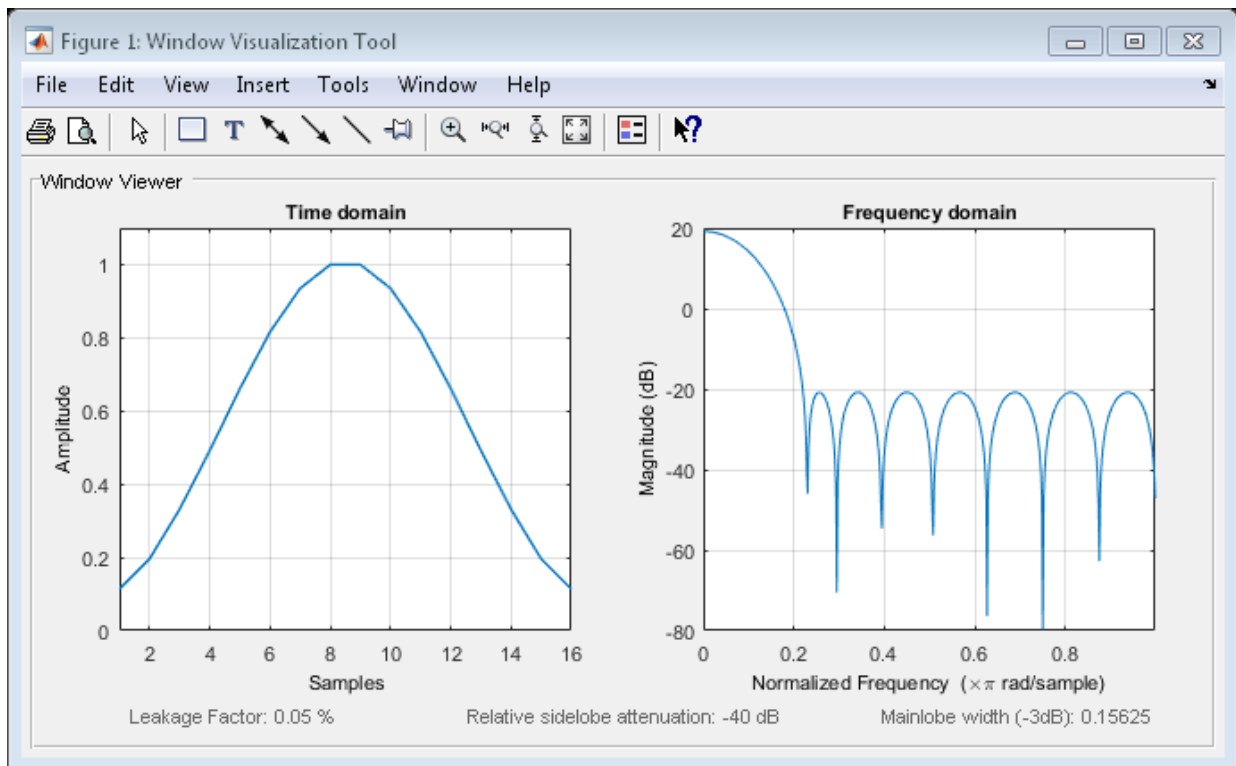

See Also

See Also

`chebwin` | `window` | `wvtool`

Topics

“Windows”

Class Attributes (MATLAB)

Property Attributes (MATLAB)

winwrite

Class: sigwin.chebwin

Package: sigwin

Save Dolph-Chebyshev window object values in ASCII file

Syntax

```
winwrite(H)
winwrite(H, 'filename')
```

Description

`winwrite(H)` opens a dialog to export the values of the Dolph-Chebyshev window object `H` to an ASCII file. The file extension `.wf` is automatically appended.

`winwrite(H, 'filename')` saves the values of the Dolph-Chebyshev window object `H` in the current folder as a column vector in the ASCII file `'filename'`. The file extension `.wf` is automatically appended to `filename`.

Examples

Dolph-Chebyshev Window

Generate a Dolph-Chebyshev window of length $N = 16$. Specify a relative sidelobe attenuation of 40 dB. Return the window values as a column vector. Write the coefficients to an ASCII file in the current directory. Show information about the window object. Display the window.

```
H = sigwin.chebwin(16,40);
win = generate(H)
win =
```

```
0.1138
0.1964
0.3319
0.4926
0.6613
0.8163
0.9353
1.0000
1.0000
0.9353
```

```
winwrite(H,'chebwin_16_40');
wininfo = info(H)
```

```
wininfo = 4×26 char array
    'Chebyshev Window      '
    '-----'
    'Length                : 16'
    'Sidelobe Attenuation  : 40'
```

```
wvtool(H)
```

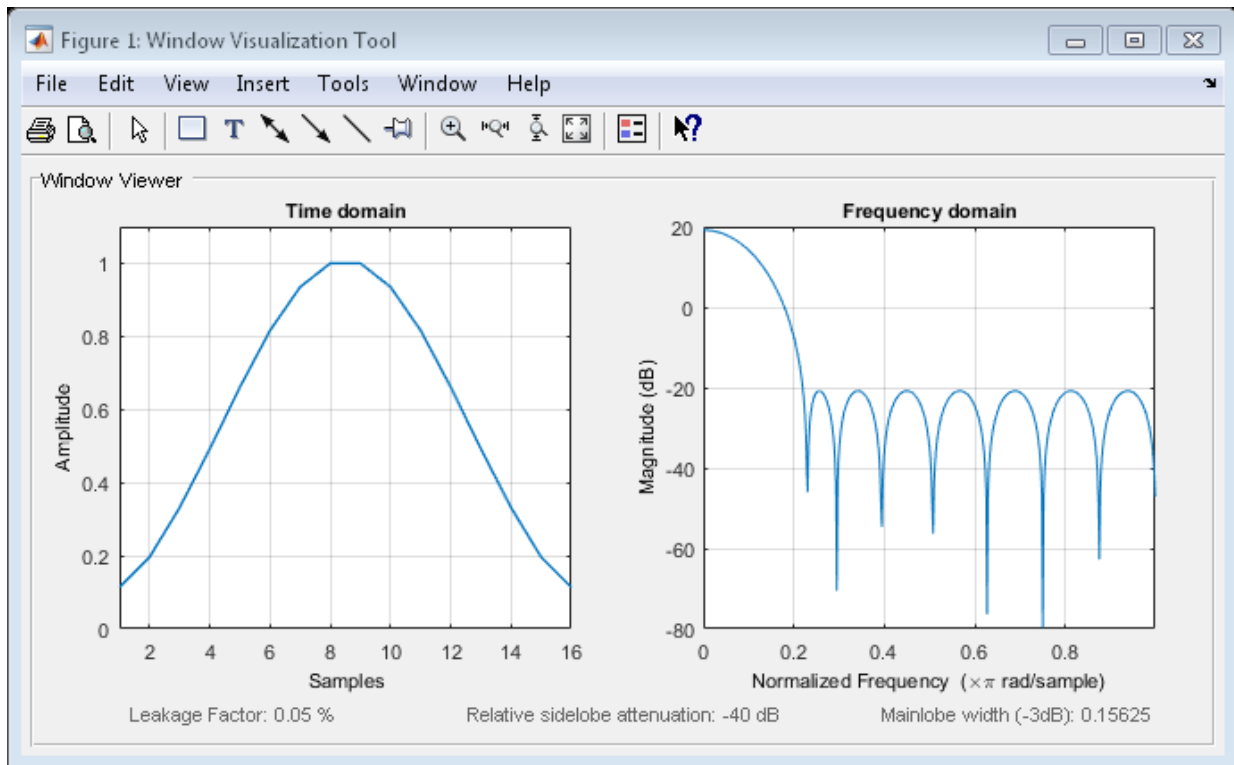

See Also

See Also

`chebwin` | `window` | `wvtool`

Topics

“Windows”

Class Attributes (MATLAB)

Property Attributes (MATLAB)

sigwin.flattopwin class

Package: sigwin

Construct flat top window object

Description

Note: The use of `sigwin.flattopwin` is not recommended. Use `flattopwin` instead.

`sigwin.flattopwin` creates a handle to a flat top window object for use in spectral analysis and FIR filtering by the window method. Object methods enable workspace import and ASCII file export of the window values.

Construction

`H = sigwin.flattopwin` returns a flat top window object `H` of length 64 with symmetric sampling.

`H = sigwin.flattopwin(Length)` returns a flat top window object of length *Length* with symmetric sampling. *Length* must be a positive integer. Entering a positive noninteger value for *Length* rounds the length to the nearest integer. Entering a 1 for *Length* results in a window with a single value of 1.

`H = sigwin.flattopwin(Length, SamplingFlag)` returns a flat top window object `H` of length *Length* with sampling *SamplingFlag*. The *SamplingFlag* can be either 'symmetric' or 'periodic'.

Properties

Length

Flat top window length. Must be a positive integer. Entering a positive noninteger value for *Length* rounds the length to the nearest integer. Entering a 1 for *Length* results in a window with a single value of 1.

SamplingFlag

'symmetric' is the default and forces exact symmetry between the first and second halves of the flat top window. A symmetric window is preferred in FIR filter design.

'periodic' designs a symmetric flat top window of length $Length+1$ and truncates the window to length $Length$. This design is preferred in spectral analysis where the window is treated as one period of a $Length$ -point periodic sequence.

Methods

generate	Generates flat top window
info	Display information about flat top window object
winwrite	Save flat top window in ASCII file

Copy Semantics

Handle. To learn how copy semantics affect your use of the class, see Copying Objects (MATLAB) in the MATLAB Programming Fundamentals documentation.

Examples

Flat Top Window

Generate a flat top window of length $N = 16$. Return its values as a column vector. Write the coefficients to an ASCII file in the current directory. Show information about the window object. Display the window.

```
H = sigwin.flattopwin(16);
```

```
win = generate(H)
```

```
win =
```

```
-0.0004
-0.0061
-0.0314
-0.0677
```

```
-0.0316
0.1982
0.6069
0.9487
0.9487
0.6069
```

```
winwrite(H, 'flattopwin_16');
wininfo = info(H)
```

```
wininfo = 4x26 char array
    'Flat Top Window'
    '-----'
    'Length          : 16'
    'Sampling Flag   : symmetric'
```

```
wvtool(H)
```

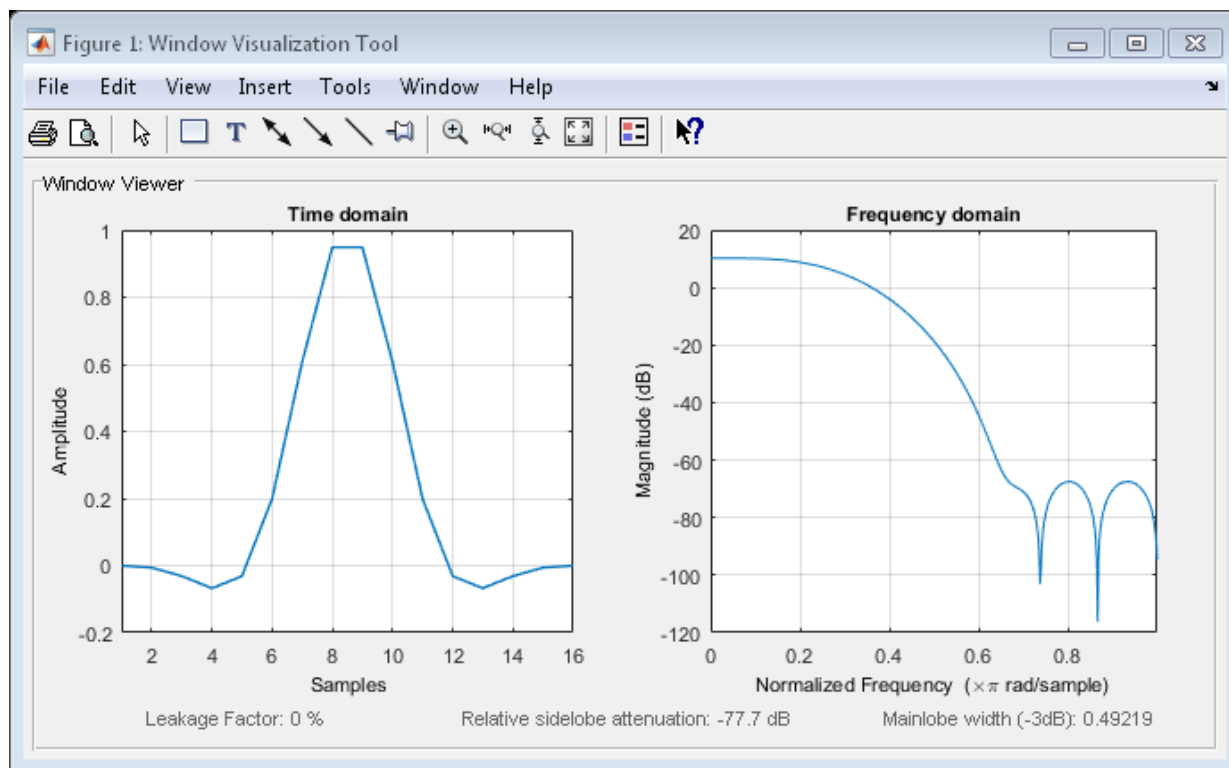

Algorithms

The following equation defines the flat top window of length N :

$$w(n) = a_0 - a_1 \cos \frac{2\pi n}{N-1} + a_2 \cos \frac{4\pi n}{N-1} - a_3 \cos \frac{6\pi n}{N-1} + a_4 \cos \frac{8\pi n}{N-1}, \quad 0 \leq n \leq M-1,$$

where M is $N/2$ for N even and $(N+1)/2$ for N odd.

The second half of the symmetric flat top window $M \leq n \leq N-1$ is obtained by flipping the first half around the midpoint. The symmetric option is the preferred method when using a flat top window in FIR filter design by the window method.

The periodic flat top window is constructed by extending the desired window length by one sample, constructing a symmetric window, and removing the last sample. The periodic version is the preferred method when using a flat top window in spectral analysis because the discrete Fourier transform assumes periodic extension of the input vector.

The coefficients are listed in the following table:

Coefficient	Value
a_0	0.21557895
a_1	0.41663158
a_2	0.277263158
a_3	0.083578947
a_4	0.006947368

References

Oppenheim, Alan V., and Ronald W. Schaffer. *Discrete-Time Signal Processing*. Upper Saddle River, NJ: Prentice Hall, 1989.

See Also

See Also

`flattopwin` | `window` | `wvtool`

Topics

“Windows”

Class Attributes (MATLAB)

Property Attributes (MATLAB)

generate

Class: sigwin.flattopwin

Package: sigwin

Generates flat top window

Syntax

```
win = generate(H)
```

Description

`win = generate(H)` returns the values of the flat top window object as a double-precision column vector.

Examples

Flat Top Window

Generate a flat top window of length $N = 16$. Return its values as a column vector. Write the coefficients to an ASCII file in the current directory. Show information about the window object. Display the window.

```
H = sigwin.flattopwin(16);
```

```
win = generate(H)
```

```
win =
```

```
-0.0004  
-0.0061  
-0.0314  
-0.0677  
-0.0316  
0.1982  
0.6069
```

```
0.9487
0.9487
0.6069
```

```
winwrite(H, 'flattopwin_16');
wininfo = info(H)
```

```
wininfo = 4x26 char array
'Flat Top Window'
'-----'
'Length      : 16'
'Sampling Flag : symmetric'
```

```
wvtool(H)
```

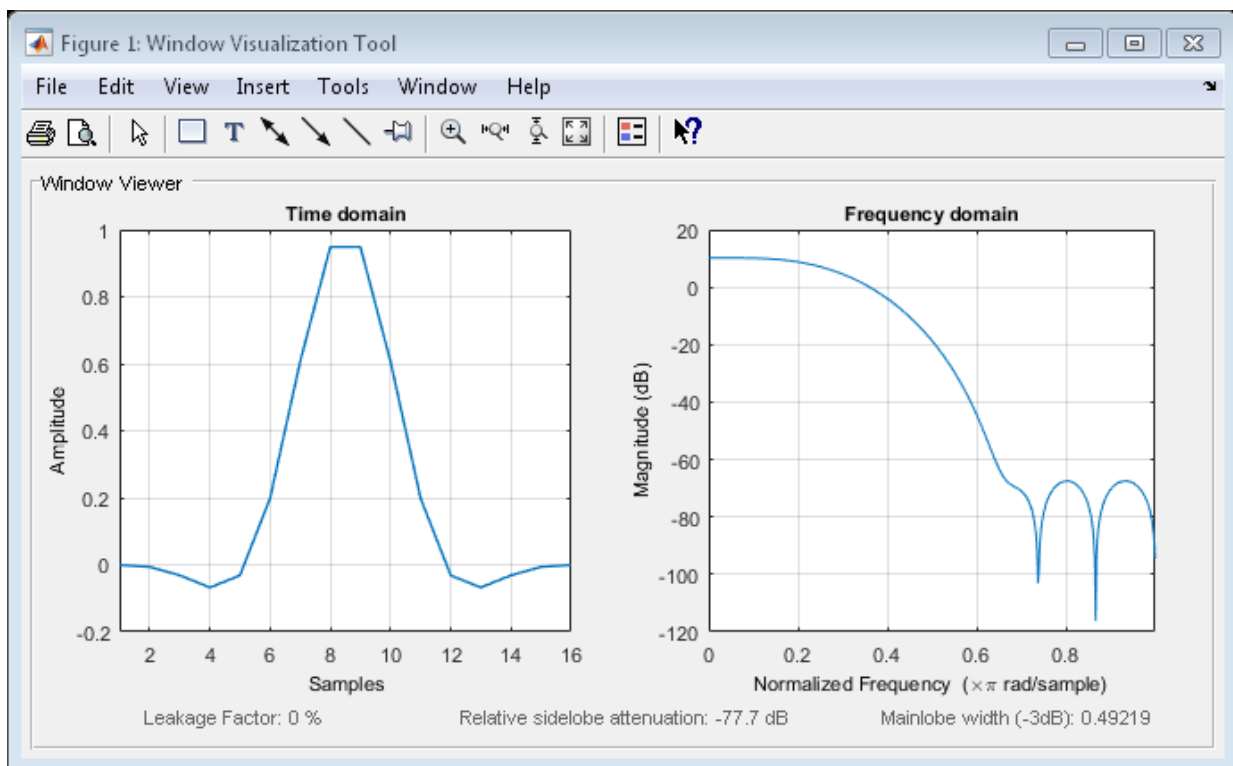

See Also

See Also

[flattopwin](#) | [window](#) | [wvtool](#)

Topics

[“Windows”](#)

[Class Attributes \(MATLAB\)](#)

[Property Attributes \(MATLAB\)](#)

info

Class: sigwin.flattopwin

Package: sigwin

Display information about flat top window object

Syntax

```
info(H)  
info_win = info(H)
```

Description

`info(H)` displays length and sampling information for the flat top window object `H`.

`info_win = info(H)` returns length and sampling information for the flat top window object `H` in the character array `info_win`.

Examples

Flat Top Window

Generate a flat top window of length $N = 16$. Return its values as a column vector. Write the coefficients to an ASCII file in the current directory. Show information about the window object. Display the window.

```
H = sigwin.flattopwin(16);
```

```
win = generate(H)
```

```
win =
```

```
-0.0004  
-0.0061  
-0.0314  
-0.0677  
-0.0316
```

```

0.1982
0.6069
0.9487
0.9487
0.6069

```

```

winwrite(H,'flattopwin_16');
wininfo = info(H)

```

```

wininfo = 4x26 char array
    'Flat Top Window'
    '-----'
    'Length          : 16'
    'Sampling Flag   : symmetric'

```

```

wvtool(H)

```

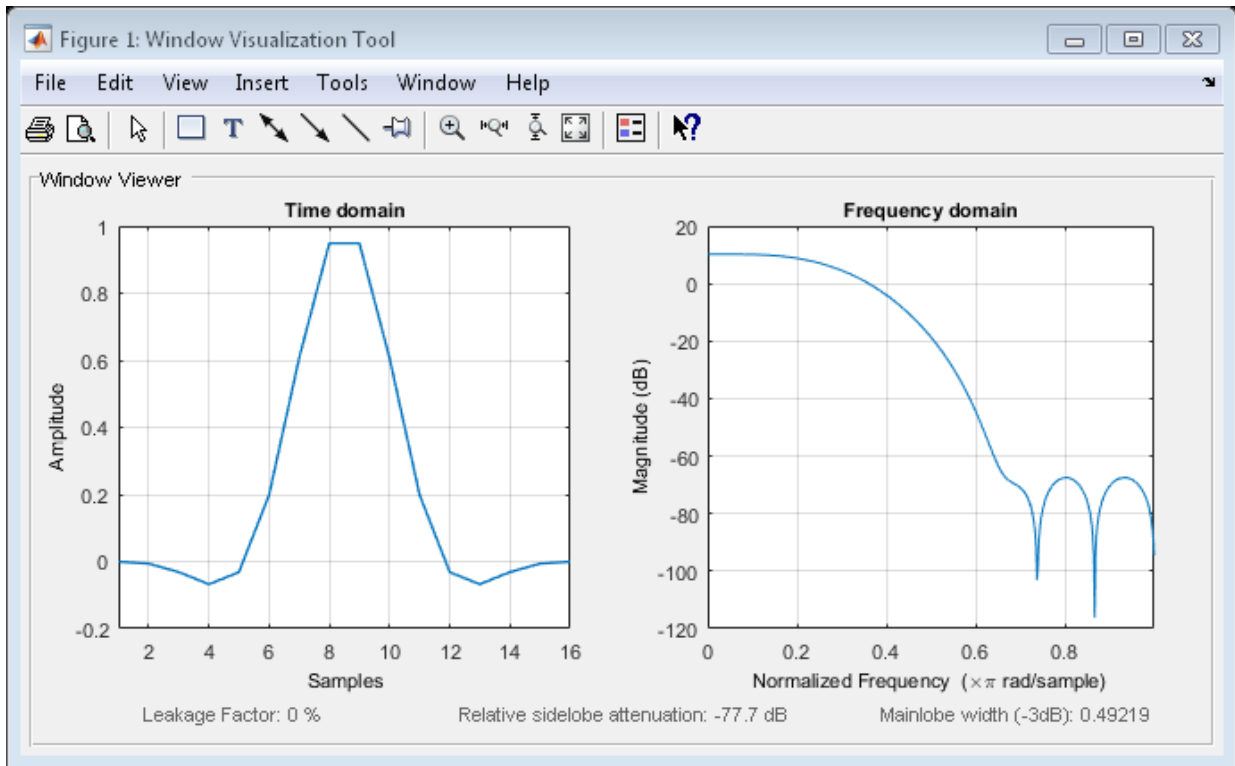

See Also

See Also

flattopwin | window | wvtool

Topics

“Windows”

Class Attributes (MATLAB)

Property Attributes (MATLAB)

winwrite

Class: sigwin.flattopwin

Package: sigwin

Save flat top window in ASCII file

Syntax

```
winwrite(H)
winwrite(H, 'filename')
```

Description

`winwrite(H)` opens a dialog to export the flat top window values to an ASCII file. The file extension `.wf` is automatically appended.

`winwrite(H, 'filename')` saves the values of the flat top window object `H` in the current folder as a column vector in the ASCII file `'filename'`. The file extension `.wf` is automatically appended to `filename`.

Examples

Flat Top Window

Generate a flat top window of length $N = 16$. Return its values as a column vector. Write the coefficients to an ASCII file in the current directory. Show information about the window object. Display the window.

```
H = sigwin.flattopwin(16);
```

```
win = generate(H)
```

```
win =
```

```
-0.0004
-0.0061
-0.0314
-0.0677
```

```
-0.0316
0.1982
0.6069
0.9487
0.9487
0.6069
```

```
winwrite(H, 'flattopwin_16');
wininfo = info(H)
```

```
wininfo = 4x26 char array
    'Flat Top Window'
    '-----'
    'Length          : 16'
    'Sampling Flag   : symmetric'
```

```
wvtool(H)
```

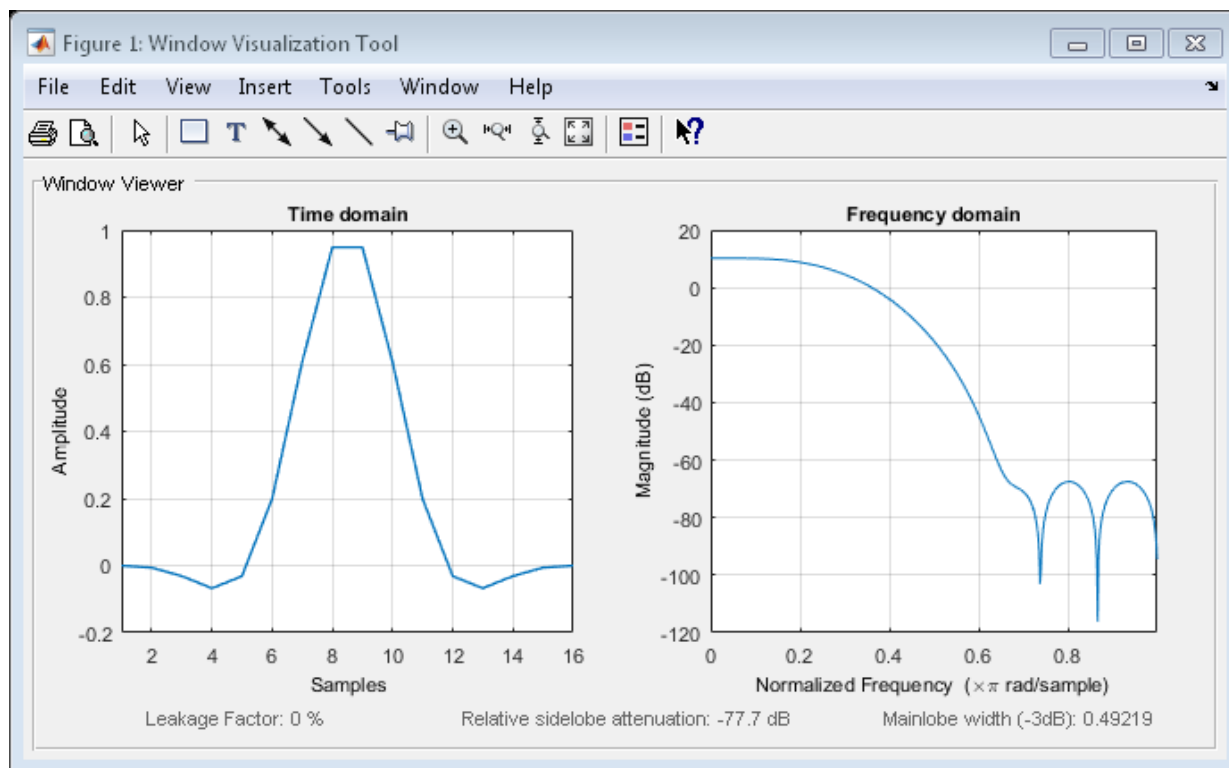

See Also

See Also

`flattopwin` | `window` | `wvtool`

Topics

“Windows”

Class Attributes (MATLAB)

Property Attributes (MATLAB)

sigwin.gausswin class

Package: sigwin

Construct Gaussian window object

Description

Note: The use of `sigwin.gausswin` is not recommended. Use `gausswin` instead.

`sigwin.gausswin` creates a handle to a Gaussian window object for use in spectral analysis and FIR filtering by the window method. Object methods enable workspace import and ASCII file export of the window values.

The following equation defines the Gaussian window of length N :

$$w(x) = e^{-\frac{1}{2}(\alpha^2 x^2 / M^2)}, \quad -M \leq x \leq M$$

where $M = (N - 1) / 2$ and x is a linearly spaced vector of length N .

Equating α with the usual standard deviation of a Gaussian value, σ , note:

$$\alpha = \frac{(N - 1)}{2\sigma}$$

Construction

`H = sigwin.gausswin` returns a Gaussian window object `H` of length 64 and dispersion parameter *alpha* of 2.5.

`H = sigwin.gausswin(Length)` returns a Gaussian window object `H` of length *Length* and dispersion parameter *alpha* of 2.5. *Length* requires a positive integer. Entering a

positive noninteger value for *Length* rounds the length to the nearest integer. Entering a 1 for *Length* results in a window with a single value of 1.

`H = sigwin.gausswin(Length,Alpha)` returns a Gaussian window object with dispersion parameter *alpha*. *alpha* requires a nonnegative real number and is inversely proportional to the standard deviation of a Gaussian value.

Properties

Length

Gaussian window length. The window length requires a positive integer. Entering a positive noninteger value for *Length* rounds the length to the nearest integer. Entering a 1 for *Length* results in a window with a single value of 1.

Alpha

Width of Gaussian window. *Alpha* is inversely proportional to the standard deviation of a Gaussian. Larger values of *Alpha* produce Gaussian windows with inflection points closer to the peak value, or narrower windows. In the frequency domain, larger values of *Alpha* produce a Gaussian window with increased spread of the main lobe in frequency but decreased sidelobe energy.

Methods

<code>generate</code>	Generates Gaussian window
<code>info</code>	Display information about Gaussian window object
<code>winwrite</code>	Save Gaussian window in ASCII file

Copy Semantics

Handle. To learn how copy semantics affect your use of the class, see Copying Objects (MATLAB) in the MATLAB Programming Fundamentals documentation.

Examples

Gaussian Windows

Generate two Gaussian windows of length $N = 64$. Specify α values of 4 and 2. Show information about the window objects. Display the windows.

```
H4 = sigwin.gausswin(64,4);
H2 = sigwin.gausswin(64,2);

wvt = wvtool(H4,H2);
legend(wvt.CurrentAxes, '\alpha=4', '\alpha=2')
```

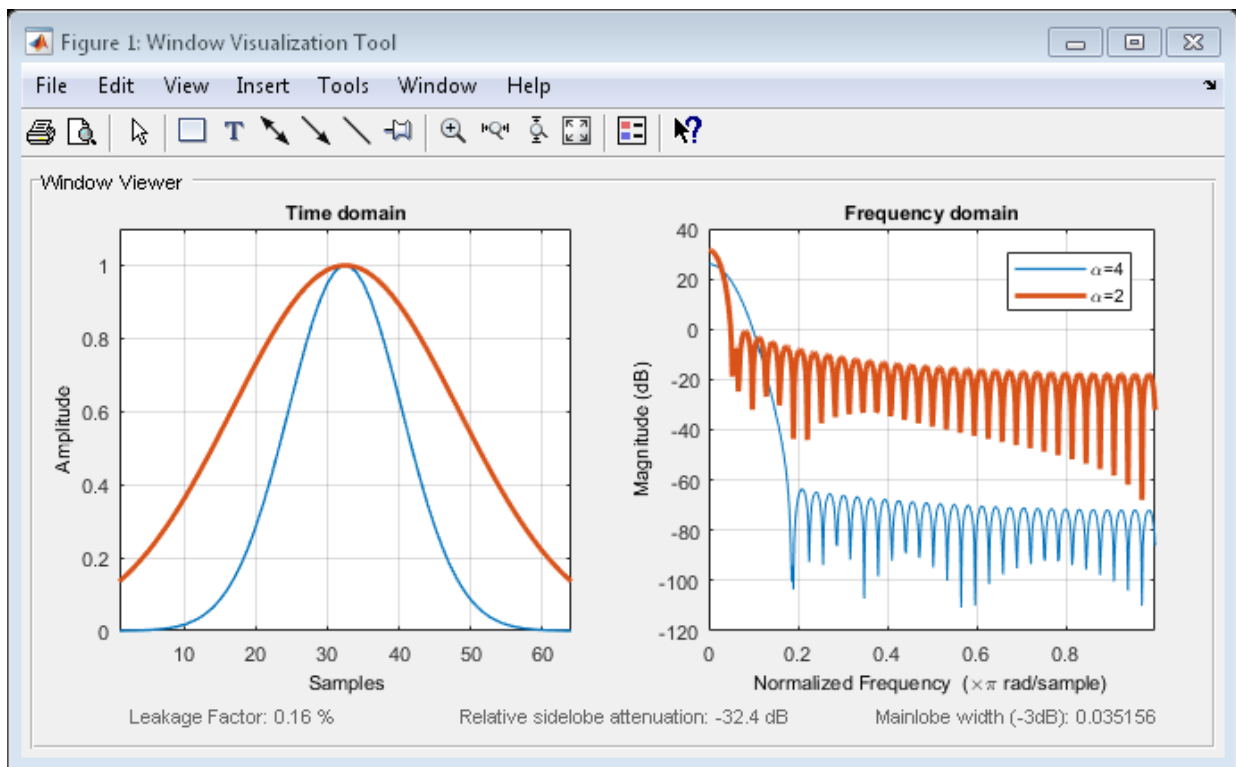

The window with $\alpha = 4$ has a wider mainlobe and less sidelobe energy.

Generate a Gaussian window with $N = 16$ and $\alpha = 3$. Return the window values as a column vector. Write the coefficients to an ASCII file in the current directory. Show information about the window object. Display the window.

```
H = sigwin.gausswin(16,3);
```

```
win = generate(H)
```

```
win =
```

```
0.0111  
0.0340  
0.0889  
0.1979  
0.3753  
0.6065  
0.8353  
0.9802  
0.9802  
0.8353
```

```
winwrite(H,'gausswin_16_3');  
wininfo = info(H)
```

```
wininfo = 4×15 char array  
'Gaussian Window'  
'-----'  
'Length : 16 '  
'Alpha : 3   '
```

```
wvtool(H)
```

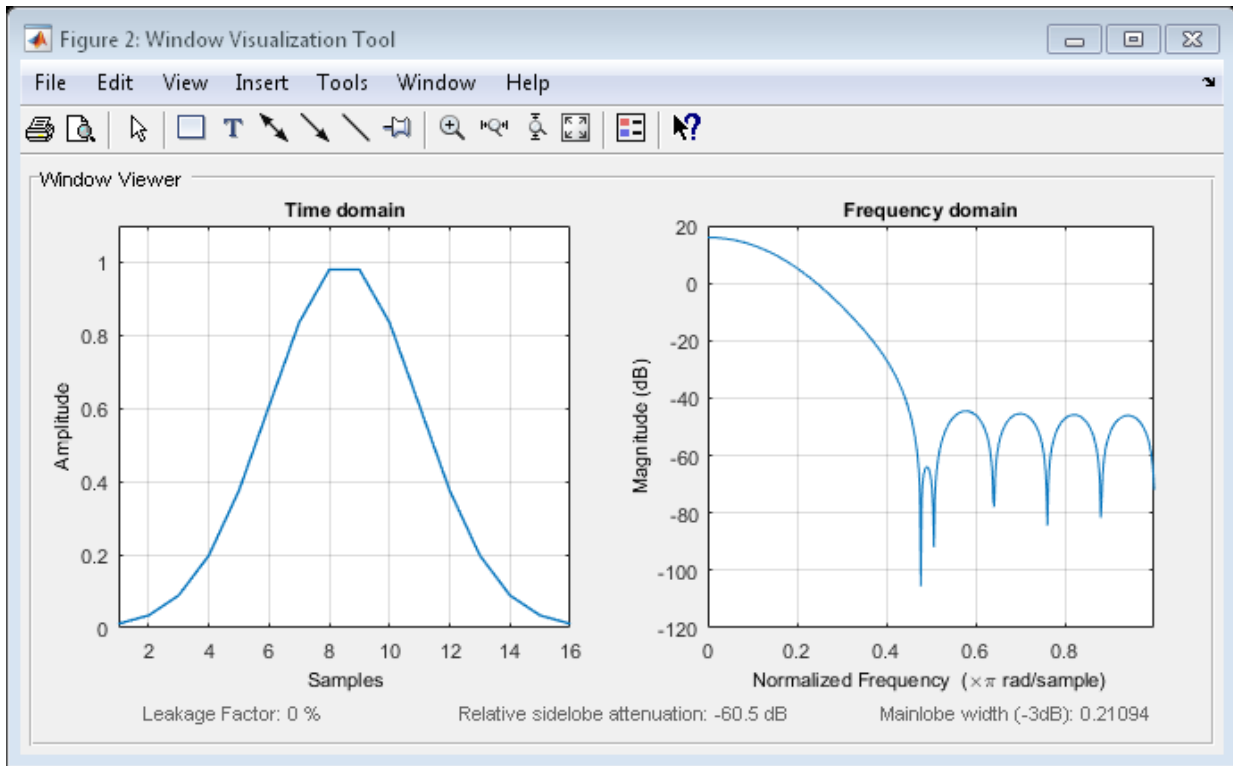

References

harris, fredric j. "On the Use of Windows for Harmonic Analysis with the Discrete Fourier Transform." *Proceedings of the IEEE*. Vol. 66, January 1978, pp. 51–83.

See Also

See Also

gausswin | window | wvtool

Topics

“Windows”

Class Attributes (MATLAB)

Property Attributes (MATLAB)

generate

Class: sigwin.gausswin

Package: sigwin

Generates Gaussian window

Syntax

```
win = generate(H)
```

Description

`win = generate(H)` returns the values of the Gaussian window object `H` as a double-precision column vector.

Examples

Gaussian Windows

Generate two Gaussian windows of length $N = 64$. Specify a values of 4 and 2. Show information about the window objects. Display the windows.

```
H4 = sigwin.gausswin(64,4);  
H2 = sigwin.gausswin(64,2);
```

```
wvt = wvtool(H4,H2);  
legend(wvt.CurrentAxes, '\alpha=4', '\alpha=2')
```

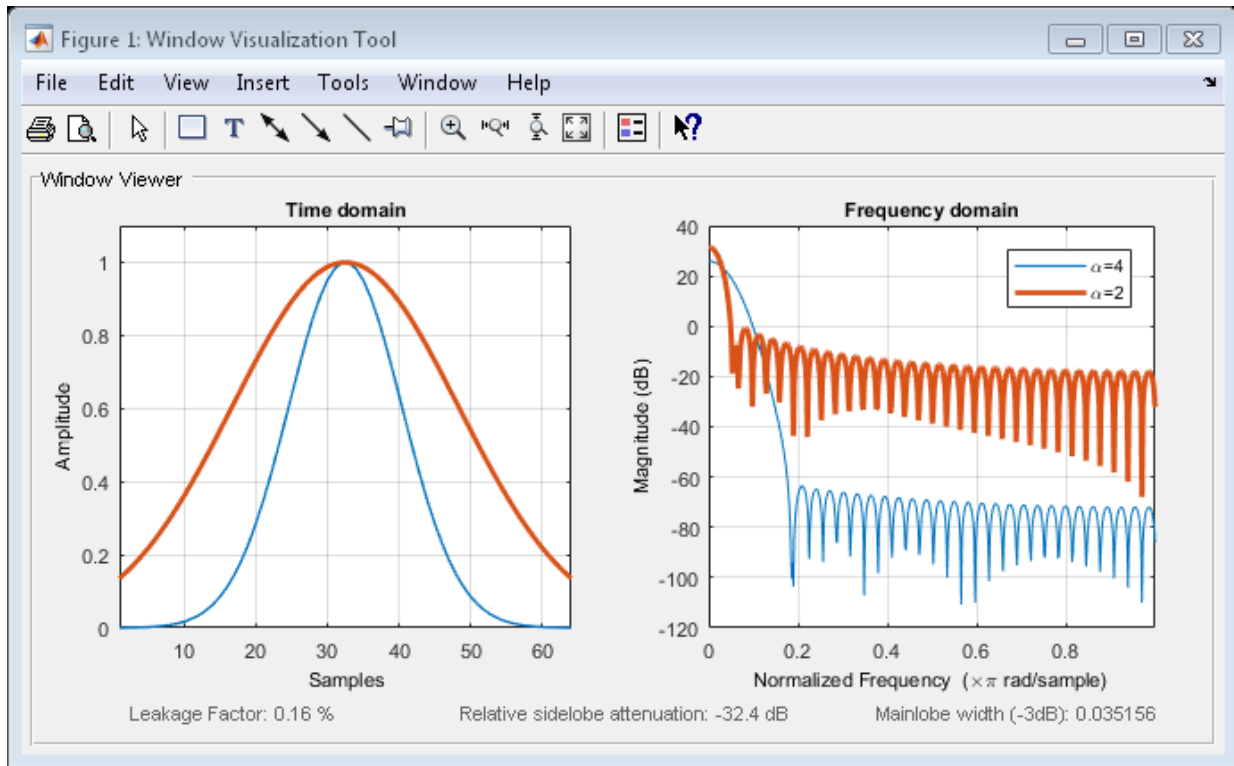
The window with $\alpha = 4$ has a wider mainlobe and less sidelobe energy.

Generate a Gaussian window with $N = 16$ and $\alpha = 3$. Return the window values as a column vector. Write the coefficients to an ASCII file in the current directory. Show information about the window object. Display the window.

```
H = sigwin.gausswin(16,3);
```

```
win = generate(H)
```

```
win =
```

```
0.0111
0.0340
0.0889
0.1979
0.3753
```

```
0.6065
0.8353
0.9802
0.9802
0.8353
```

```
winwrite(H, 'gausswin_16_3');
wininfo = info(H)
```

```
wininfo = 4x15 char array
'Gaussian Window'
'-----'
'Length  : 16  '
'Alpha   : 3   '
```

```
wvtool(H)
```

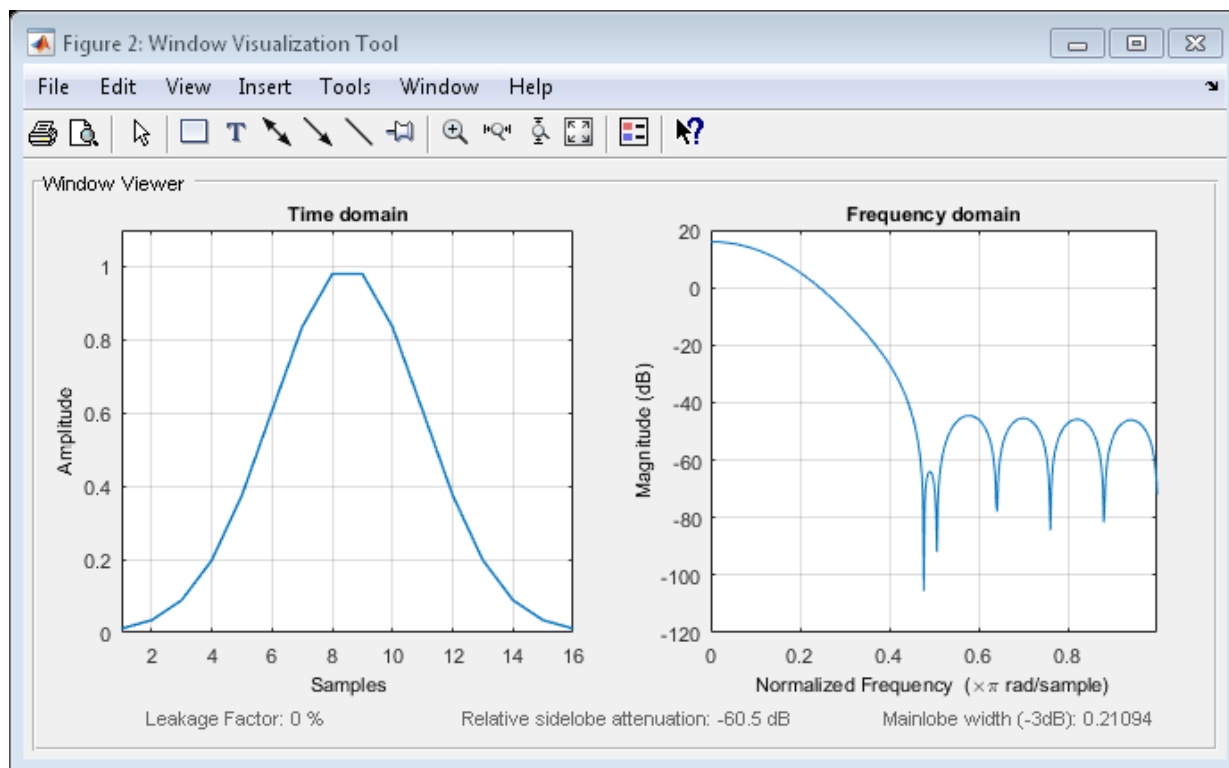

See Also

See Also

gausswin | window | wvtool

Topics

“Windows”

Class Attributes (MATLAB)

Property Attributes (MATLAB)

info

Class: sigwin.gausswin

Package: sigwin

Display information about Gaussian window object

Syntax

```
info(H)  
info_win = info(H)
```

Description

`info(H)` displays length and dispersion information for the Gaussian window object `H`.

`info_win = info(H)` returns length and dispersion information for the Gaussian window object `H` in the character array `info_win`.

Examples

Gaussian Windows

Generate two Gaussian windows of length $N = 64$. Specify α values of 4 and 2. Show information about the window objects. Display the windows.

```
H4 = sigwin.gausswin(64,4);  
H2 = sigwin.gausswin(64,2);  
  
wvt = wvtool(H4,H2);  
legend(wvt.CurrentAxes, '\alpha=4', '\alpha=2')
```

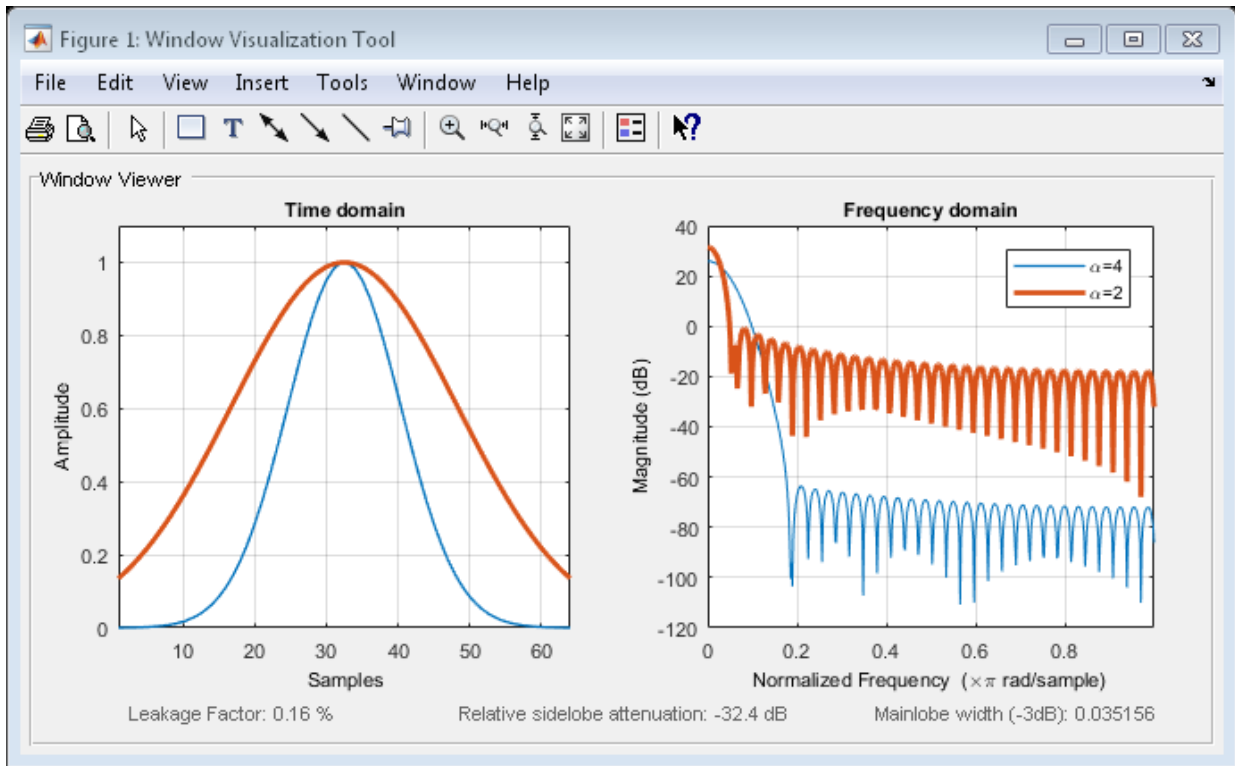

The window with $\alpha = 4$ has a wider mainlobe and less sidelobe energy.

Generate a Gaussian window with $N = 16$ and $\alpha = 3$. Return the window values as a column vector. Write the coefficients to an ASCII file in the current directory. Show information about the window object. Display the window.

```
H = sigwin.gausswin(16,3);
```

```
win = generate(H)
```

```
win =
```

```
0.0111
0.0340
0.0889
0.1979
0.3753
```

```
0.6065
0.8353
0.9802
0.9802
0.8353
```

```
winwrite(H, 'gausswin_16_3');
wininfo = info(H)
```

```
wininfo = 4x15 char array
'Gaussian Window'
'-----'
'Length  : 16  '
'Alpha   : 3   '
```

```
wvtool(H)
```

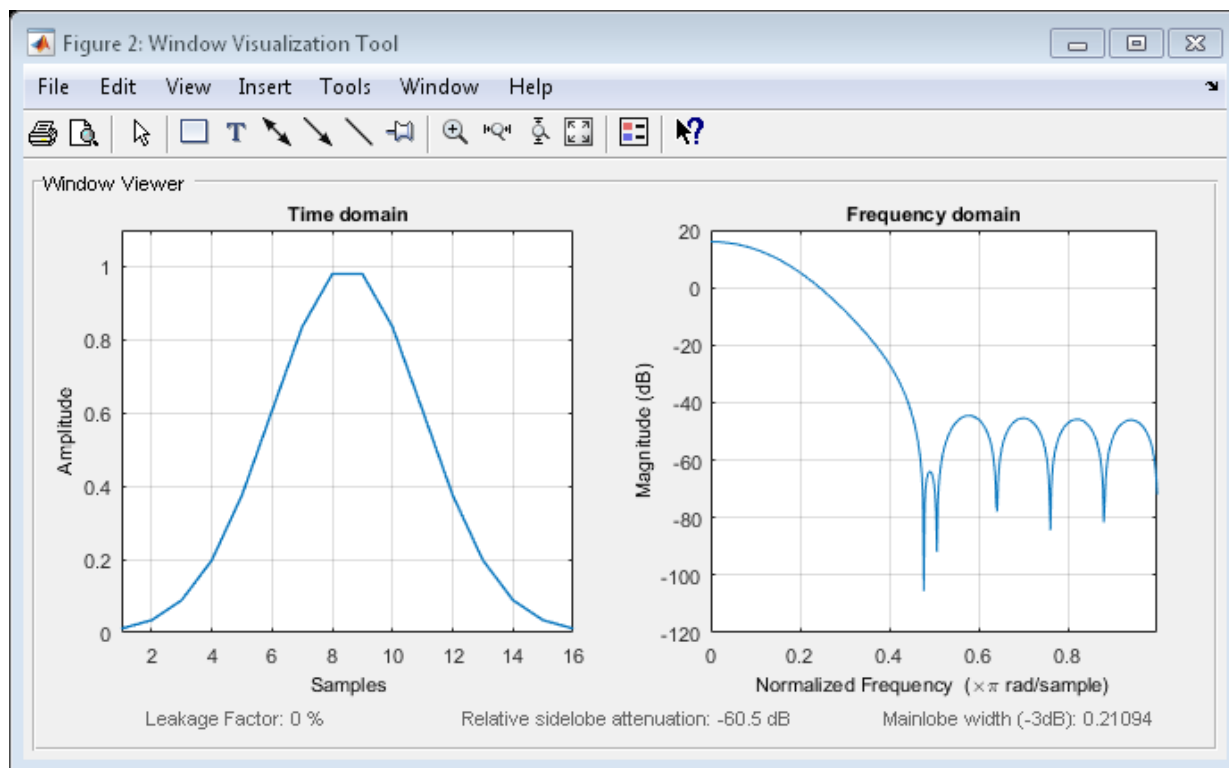

See Also

See Also

gausswin | window | wvtool

Topics

“Windows”

Class Attributes (MATLAB)

Property Attributes (MATLAB)

winwrite

Class: sigwin.gausswin

Package: sigwin

Save Gaussian window in ASCII file

Syntax

```
winwrite(H)
winwrite(H, 'filename')
```

Description

`winwrite(H)` opens a dialog to export the values of Gaussian window object `H` to an ASCII file. The file extension `.wf` is automatically appended.

`winwrite(H, 'filename')` saves the values of the Gaussian window object `H` in the current folder as a column vector in the ASCII file `'filename'`. The file extension `.wf` is automatically appended to `filename`.

Examples

Gaussian Windows

Generate two Gaussian windows of length $N = 64$. Specify α values of 4 and 2. Show information about the window objects. Display the windows.

```
H4 = sigwin.gausswin(64,4);
H2 = sigwin.gausswin(64,2);

wvt = wvtool(H4,H2);
legend(wvt.CurrentAxes, '\alpha=4', '\alpha=2')
```

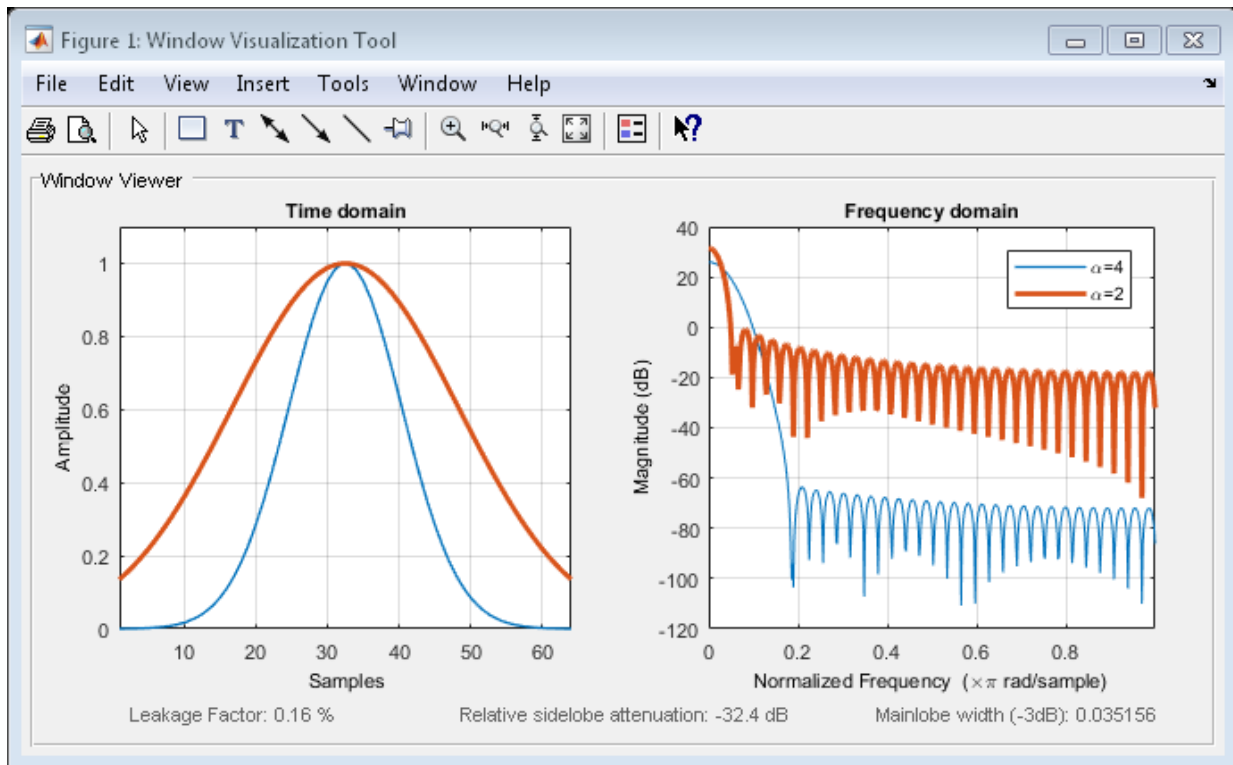
The window with $\alpha = 4$ has a wider mainlobe and less sidelobe energy.

Generate a Gaussian window with $N = 16$ and $\alpha = 3$. Return the window values as a column vector. Write the coefficients to an ASCII file in the current directory. Show information about the window object. Display the window.

```
H = sigwin.gausswin(16,3);
```

```
win = generate(H)
```

```
win =
```

```
0.0111
0.0340
0.0889
0.1979
0.3753
```

```
0.6065
0.8353
0.9802
0.9802
0.8353
```

```
winwrite(H, 'gausswin_16_3');
wininfo = info(H)
```

```
wininfo = 4x15 char array
'Gaussian Window'
'-----'
'Length  : 16  '
'Alpha   : 3   '
```

```
wvtool(H)
```

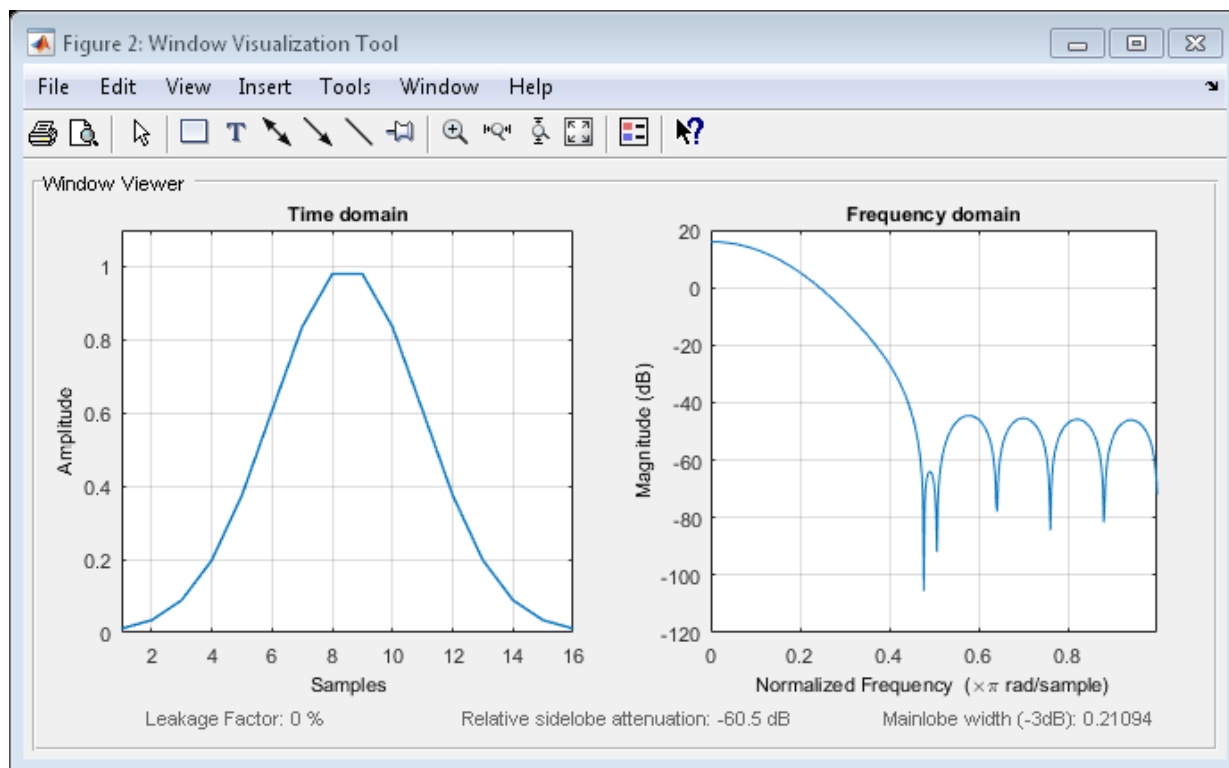

See Also

See Also

gausswin | window | wvtool

Topics

“Windows”

Class Attributes (MATLAB)

Property Attributes (MATLAB)

sigwin.hamming class

Package: sigwin

Construct Hamming window object

Description

Note: The use of `sigwin.hamming` is not recommended. Use `hamming` instead.

`sigwin.hamming` creates a handle to a Hamming window object for use in spectral analysis and FIR filtering by the window method. Object methods enable workspace import and ASCII file export of the window values.

The following equation defines the Hamming window of length N :

$$w(n) = 0.54 - 0.46 \cos \frac{2\pi n}{N-1}, \quad 0 \leq n \leq M-1$$

where M is $N/2$ for N even and $(N+1)/2$ for N odd.

The second half of the symmetric Hamming window $M \leq n \leq N-1$ is obtained by flipping the first half around the midpoint. The symmetric option is the preferred method when using a Hamming window in FIR filter design.

The periodic Hamming window is constructed by extending the desired window length by one sample, constructing a symmetric window, and removing the last sample. The periodic version is the preferred method when using a Hamming window in spectral analysis because the discrete Fourier transform assumes periodic extension of the input vector.

Construction

`H = sigwin.hamming` returns a symmetric Hamming window object `H` of length 64.

`H = sigwin.hamming(Length)` returns a symmetric Hamming window object with length `Length`. `Length` must be a positive integer. Entering a positive noninteger value

for *Length* rounds the length to the nearest integer. Entering a 1 for *Length* results in a window with a single value of 1.

`H = sigwin.hamming(Length,SamplingFlag)` returns a Hamming window with sampling *Sampling_Flag*. The *SamplingFlag* can be either 'symmetric' or 'periodic'.

Properties

Length

Hamming window length. The window length must be a positive integer. Entering a positive noninteger value for *Length* rounds the length to the nearest integer. Entering a 1 for *Length* results in a window with a single value of 1.

SamplingFlag

'symmetric' is the default and forces exact symmetry between the first and second halves of the Hamming window. A symmetric window is preferred in FIR filter design by the window method.

'periodic' designs a symmetric Hamming window of length *Length+1* and truncates the window to length *Length*. This design is preferred in spectral analysis where the window is treated as one period of a *Length*-point periodic sequence.

Methods

generate	Generates Hamming window
info	Display information about Hamming window object
winwrite	Save Hamming window in ASCII file

Copy Semantics

Handle. To learn how copy semantics affect your use of the class, see Copying Objects (MATLAB) in the MATLAB Programming Fundamentals documentation.

Examples

Hamming Windows

Generate two Hamming windows:

- The first window has $N = 64$ and is symmetric.
- The second window has $N = 63$ and is periodic.

Display the two windows.

```
Hs = sigwin.hamming(64, 'symmetric');  
Hp = sigwin.hamming(63, 'periodic')
```

```
Hp =  
      Name: 'Hamming'  
      SamplingFlag: 'periodic'  
      Length: 63
```

```
wvt = wvtool(Hs, Hp);  
legend(wvt.CurrentAxes, 'Symmetric', 'Periodic')
```

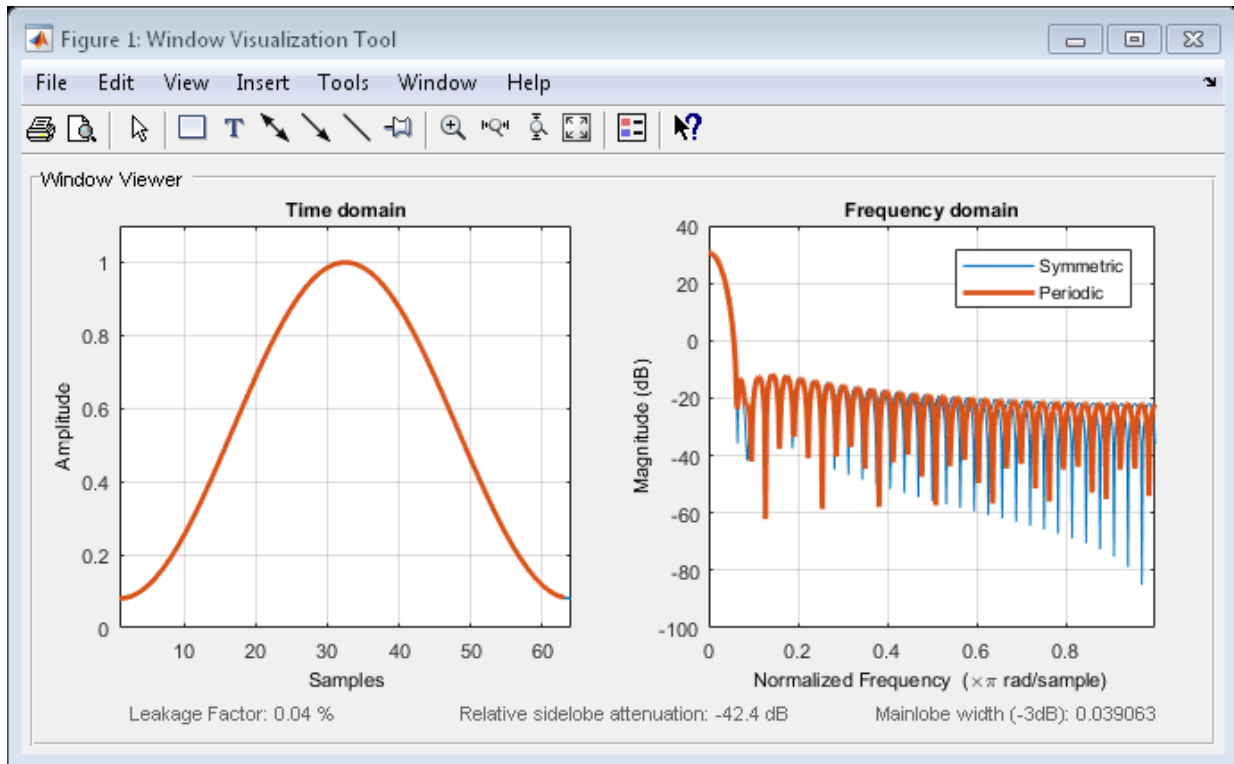

Generate a symmetric Hamming window with $N = 16$. Return the window values as a column vector. Write the coefficients to an ASCII file in the current directory. Show information about the window object. Display the window.

```
H = sigwin.hamming(16);
```

```
win = generate(H)
```

```
win =
```

```
0.0800
0.1198
0.2322
0.3979
0.5881
0.7700
0.9121
```

```
0.9899
0.9899
0.9121
```

```
winwrite(H, 'hamming_16');
wininfo = info(H)
```

```
wininfo = 4x26 char array
'Hamming Window'
'-----'
'Length      : 16'
'Sampling Flag : symmetric'
```

```
wvtool(H)
```

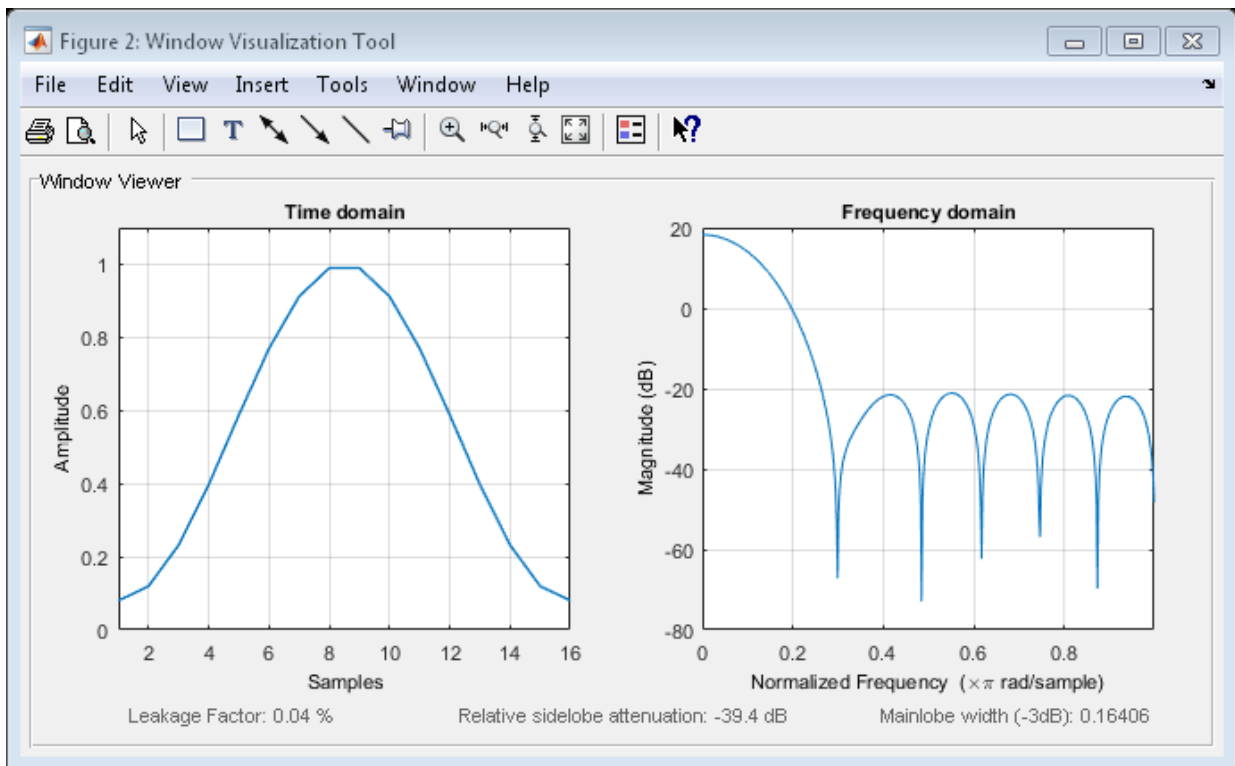

References

Oppenheim, Alan V., and Ronald W. Schaffer. *Discrete-Time Signal Processing*. Upper Saddle River, NJ: Prentice Hall, 1989.

See Also

See Also

hamming | window | wvtool

Topics

“Windows”

Class Attributes (MATLAB)

Property Attributes (MATLAB)

generate

Class: sigwin.hamming

Package: sigwin

Generates Hamming window

Syntax

```
win = generate(H)
```

Description

`win = generate(H)` returns the values of the Hamming window object as a double-precision column vector.

Examples

Hamming Windows

Generate two Hamming windows:

- The first window has $N = 64$ and is symmetric.
- The second window has $N = 63$ and is periodic.

Display the two windows.

```
Hs = sigwin.hamming(64, 'symmetric');  
Hp = sigwin.hamming(63, 'periodic')
```

```
Hp =  
      Name: 'Hamming'  
      SamplingFlag: 'periodic'  
      Length: 63
```

```
wvt = wvtool(Hs, Hp);
```

```
legend(wvt.CurrentAxes, 'Symmetric', 'Periodic')
```

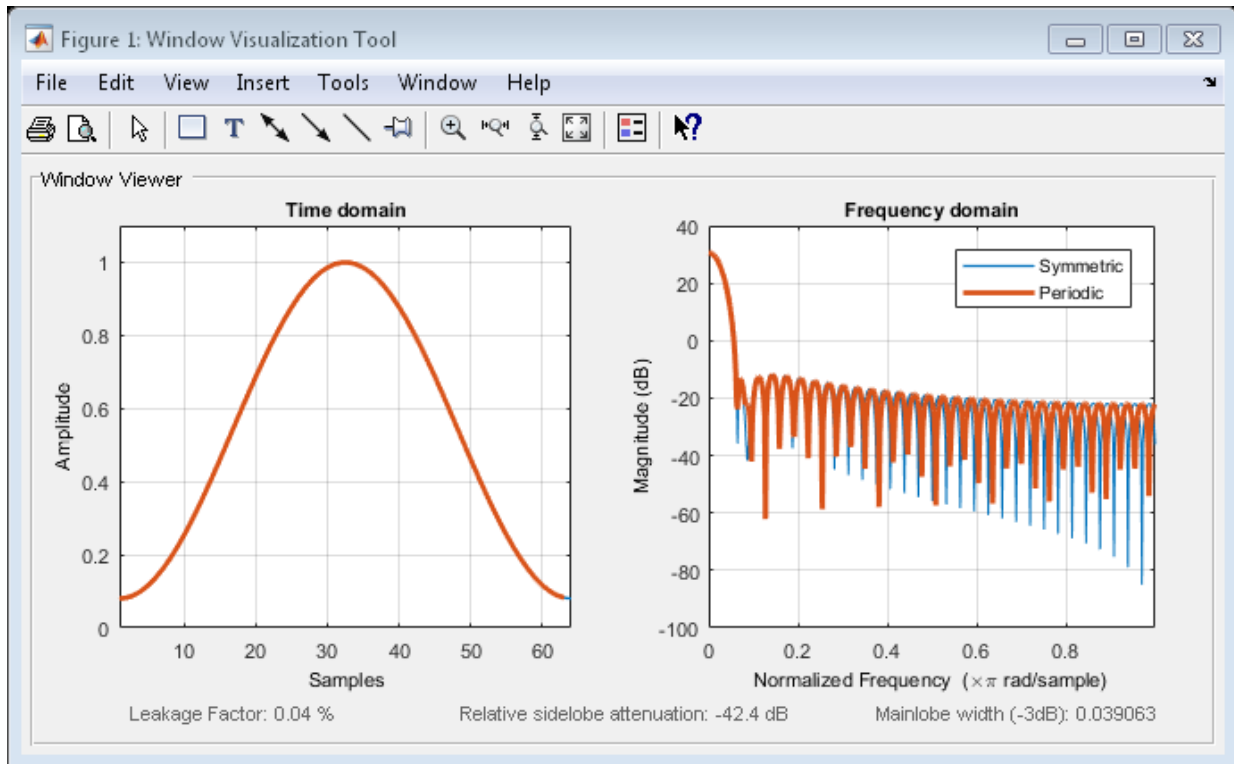

Generate a symmetric Hamming window with $N = 16$. Return the window values as a column vector. Write the coefficients to an ASCII file in the current directory. Show information about the window object. Display the window.

```
H = sigwin.hamming(16);
```

```
win = generate(H)
```

```
win =
```

```
0.0800
0.1198
0.2322
0.3979
0.5881
```

```

0.7700
0.9121
0.9899
0.9899
0.9121

winwrite(H,'hamming_16');
wininfo = info(H)

wininfo = 4x26 char array
    'Hamming Window'
    '-----'
    'Length          : 16'
    'Sampling Flag   : symmetric'

wvtool(H)

```

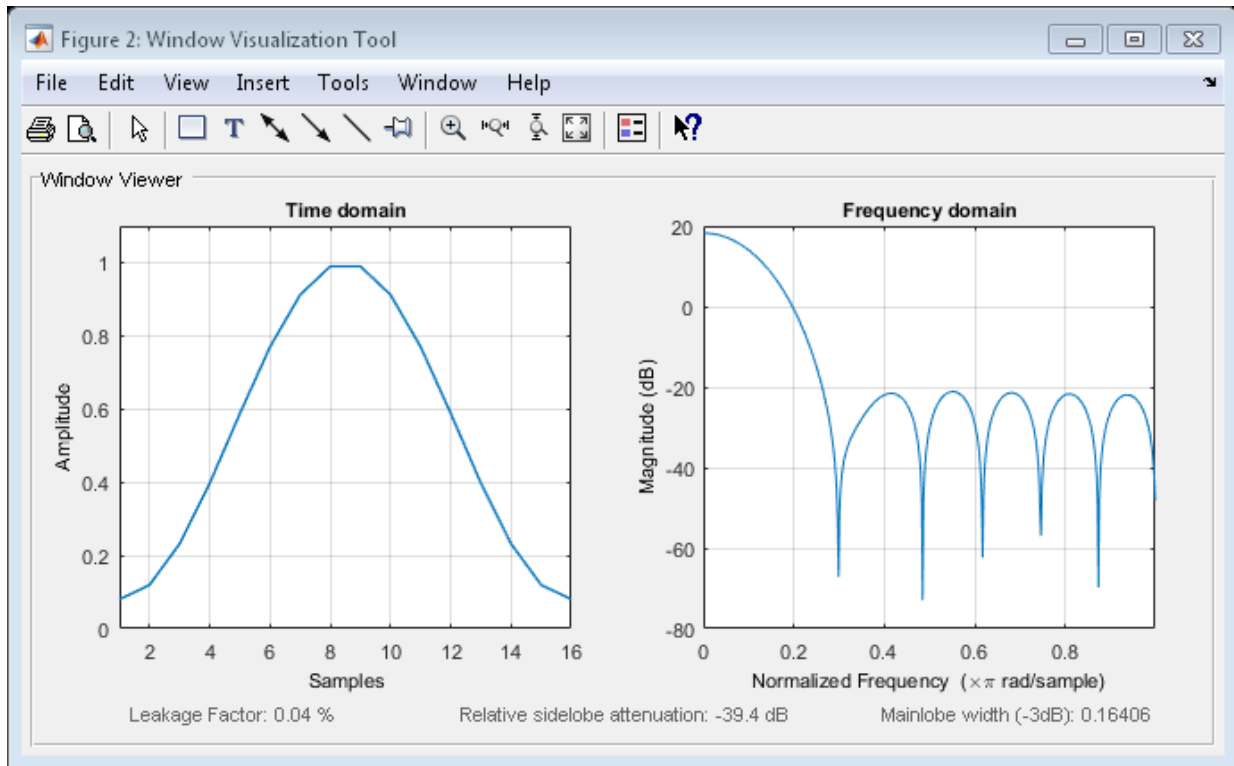

See Also

See Also

hamming | window | wvtool

Topics

“Windows”

Class Attributes (MATLAB)

Property Attributes (MATLAB)

info

Class: sigwin.hamming

Package: sigwin

Display information about Hamming window object

Syntax

```
info(H)
info_win = info(H)
```

Description

`info(H)` displays length and sampling information for the Hamming window object `H`.

`info_win = info(H)` returns length and sampling information for the Hamming window object `H` in the character array `info_win`.

Examples

Hamming Windows

Generate two Hamming windows:

- The first window has $N = 64$ and is symmetric.
- The second window has $N = 63$ and is periodic.

Display the two windows.

```
Hs = sigwin.hamming(64, 'symmetric');
Hp = sigwin.hamming(63, 'periodic')
```

```
Hp =
      Name: 'Hamming'
  SamplingFlag: 'periodic'
      Length: 63
```

```
wvt = wvtool(Hs,Hp);
legend(wvt.CurrentAxes, 'Symmetric', 'Periodic')
```

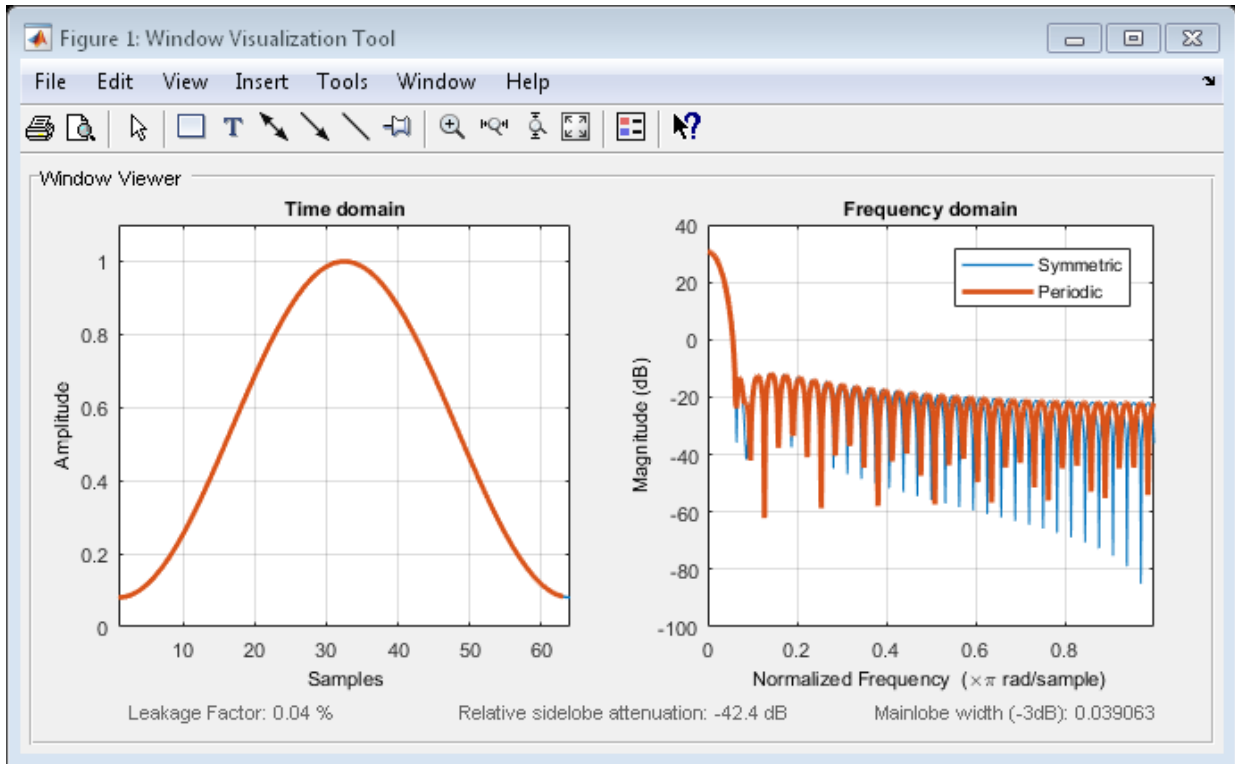

Generate a symmetric Hamming window with $N = 16$. Return the window values as a column vector. Write the coefficients to an ASCII file in the current directory. Show information about the window object. Display the window.

```
H = sigwin.hamming(16);
win = generate(H)
win =
    0.0800
    0.1198
    0.2322
    0.3979
```

```
0.5881
0.7700
0.9121
0.9899
0.9899
0.9121
```

```
winwrite(H, 'hamming_16');
wininfo = info(H)
```

```
wininfo = 4x26 char array
    'Hamming Window'
    '-----'
    'Length          : 16'
    'Sampling Flag   : symmetric'
```

```
wvtool(H)
```

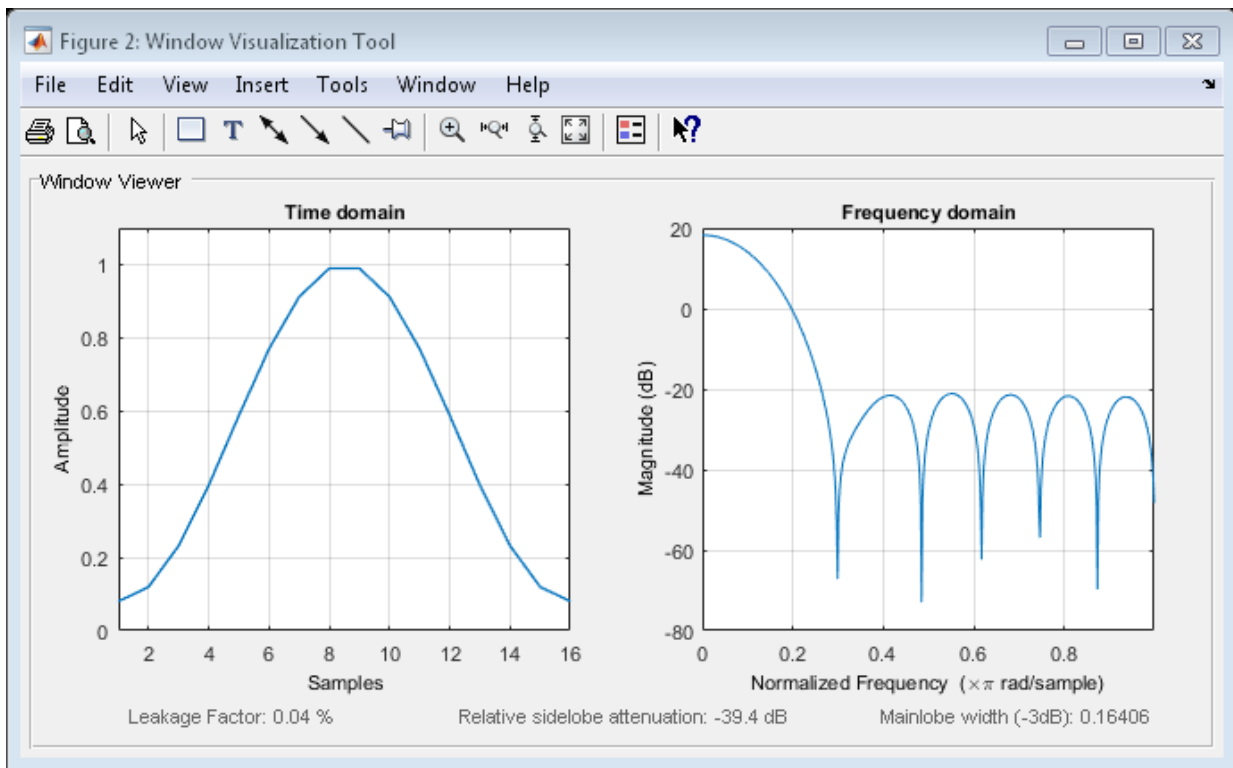

See Also

See Also

hamming | window | wvtool

Topics

“Windows”

Class Attributes (MATLAB)

Property Attributes (MATLAB)

winwrite

Class: sigwin.hamming

Package: sigwin

Save Hamming window in ASCII file

Syntax

```
winwrite(H)
winwrite(H, 'filename')
```

Description

`winwrite(H)` opens a dialog to export the Hamming window values to an ASCII file. The file extension `.wf` is automatically appended.

`winwrite(H, 'filename')` saves the values of the Hamming window object `H` in the current folder as a column vector in the ASCII file `'filename'`. The file extension `.wf` is automatically appended to `filename`.

Examples

Hamming Windows

Generate two Hamming windows:

- The first window has $N = 64$ and is symmetric.
- The second window has $N = 63$ and is periodic.

Display the two windows.

```
Hs = sigwin.hamming(64, 'symmetric');
Hp = sigwin.hamming(63, 'periodic')
```

```
Hp =
```

```
Name: 'Hamming'
SamplingFlag: 'periodic'
Length: 63
```

```
wvt = wvtool(Hs,Hp);
legend(wvt.CurrentAxes,'Symmetric','Periodic')
```

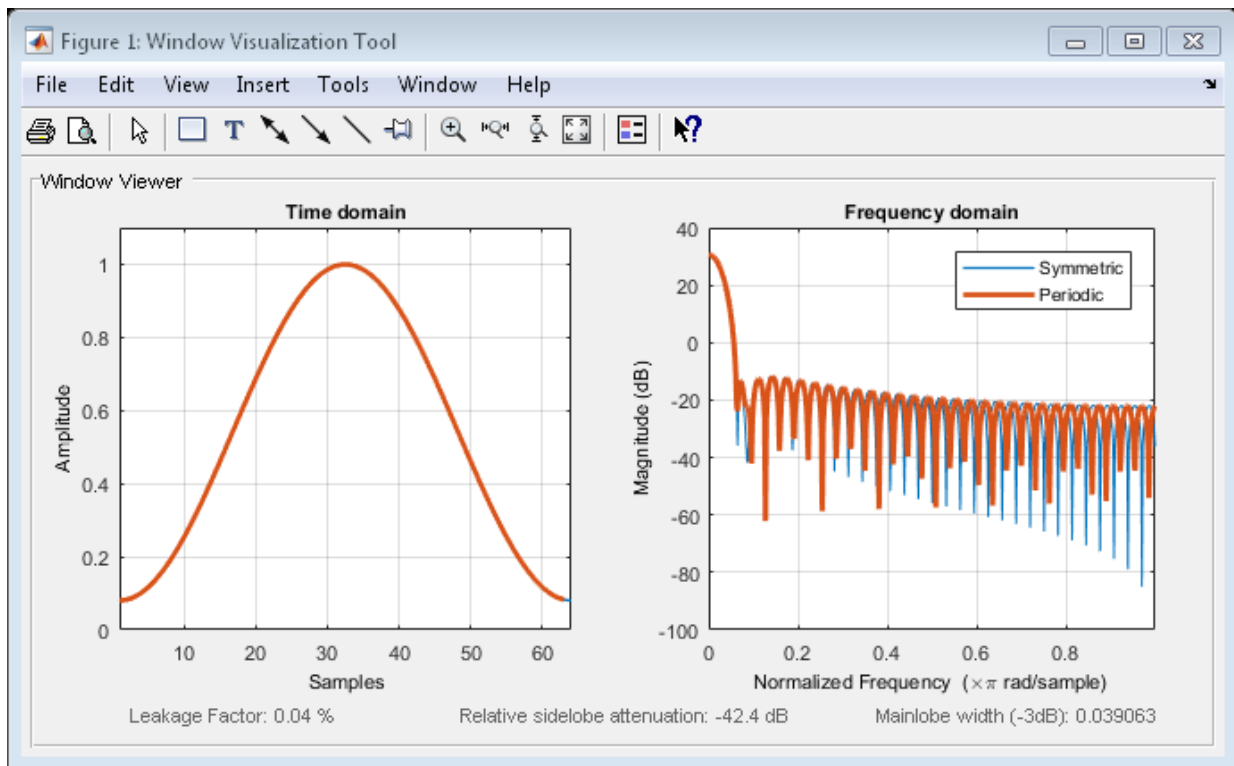

Generate a symmetric Hamming window with $N = 16$. Return the window values as a column vector. Write the coefficients to an ASCII file in the current directory. Show information about the window object. Display the window.

```
H = sigwin.hamming(16);
win = generate(H)
```

```
win =  
  
    0.0800  
    0.1198  
    0.2322  
    0.3979  
    0.5881  
    0.7700  
    0.9121  
    0.9899  
    0.9899  
    0.9121  
  
winwrite(H,'hamming_16');  
wininfo = info(H)  
  
wininfo = 4×26 char array  
    'Hamming Window           '  
    '-----'                '  
    'Length           : 16     '  
    'Sampling Flag   : symmetric'  
wvtool(H)
```

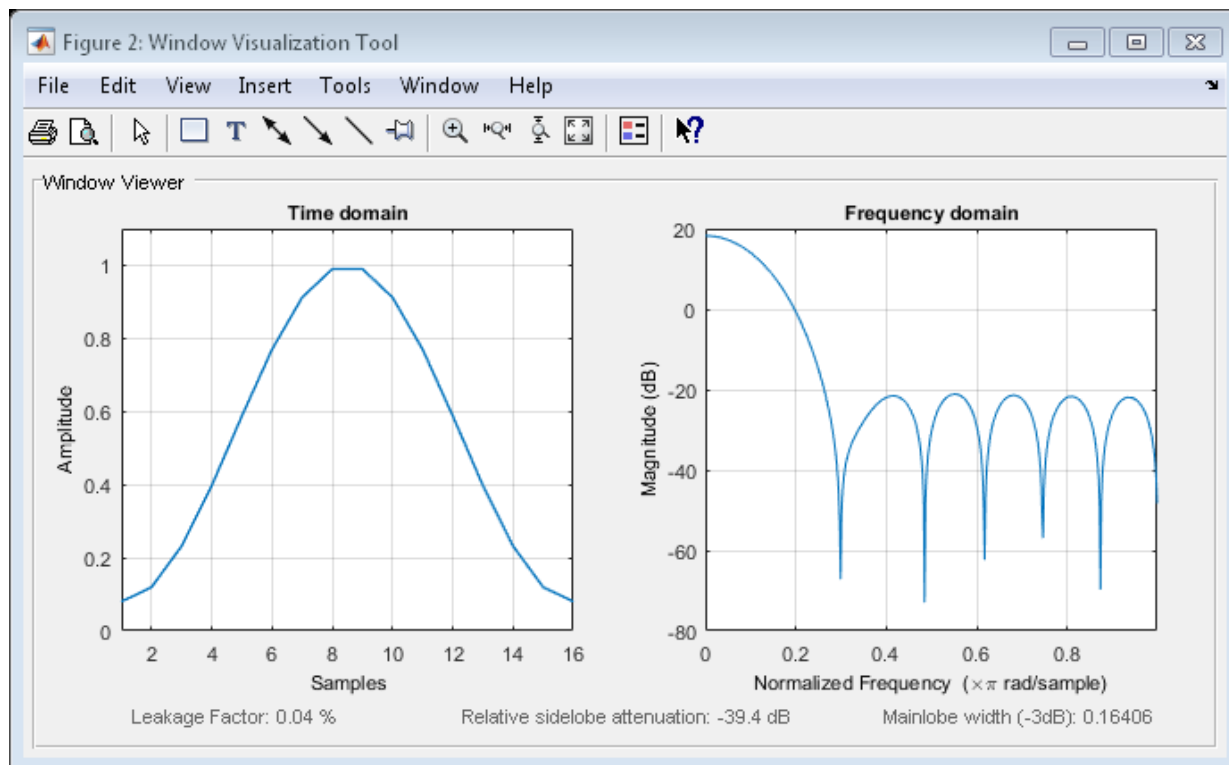

See Also

See Also

hamming | window | wvtool

Topics

“Windows”

Class Attributes (MATLAB)

Property Attributes (MATLAB)

sigwin.hann class

Package: sigwin

Construct Hann (Hanning) window object

Description

Note: The use of `sigwin.hann` is not recommended. Use `hann` instead.

`sigwin.hann` creates a handle to a Hann window object for use in spectral analysis and FIR filtering by the window method. Object methods enable workspace import and ASCII file export of the window values.

The symmetric Hann window of length N is defined as:

$$w(n) = \frac{1}{2} \left(1 - \cos \frac{2\pi n}{N-1} \right), \quad 0 \leq n \leq M-1$$

where M is $N/2$ for N even and $(N+1)/2$ for N odd.

The second half of the symmetric Hann window $M \leq n \leq N-1$ is obtained by flipping the first half around the midpoint. The symmetric option is the preferred method when using a Hann window in FIR filter design.

The periodic Hann window is constructed by extending the desired window length by one sample, constructing a symmetric window, and removing the last sample. The periodic version is the preferred method when using a Hann window in spectral analysis because the discrete Fourier transform assumes periodic extension of the input vector.

Construction

`H = sigwin.hann` returns a symmetric Hann window object `H` of length 64.

`H = sigwin.hann(Length)` returns a symmetric Hann window object with length *Length*. *Length* requires a positive integer. Entering a positive noninteger value for

Length rounds the length to the nearest integer. Entering a 1 for *Length* results in a window with a single value of 1.

`H = sigwin.hann(Length,SamplingFlag)` returns a Hann window object with sampling *Sampling_Flag*. The *SamplingFlag* can be either 'symmetric' or 'periodic'.

Properties

Length

Hann window length. Must be a positive integer. Entering a positive noninteger value for *Length* rounds the length to the nearest integer. Entering a 1 for *Length* results in a window with a single value of 1.

SamplingFlag

'symmetric' is the default and forces exact symmetry between the first and second halves of the Hann window. A symmetric window is preferred in FIR filter design by the window method.

'periodic' designs a symmetric Hann window of length *Length*+1 and truncates the window to length *Length*. This design is preferred in spectral analysis where the window is treated as one period of a *Length*-point periodic sequence.

Methods

generate	Generates Hann window
info	Display information about Hann window object
winwrite	Save Hann window object values in ASCII file

Copy Semantics

Handle. To learn how copy semantics affect your use of the class, see Copying Objects (MATLAB) in the MATLAB Programming Fundamentals documentation.

Examples

Hann Windows

Generate two Hann windows:

- The first window has $N = 64$ and is symmetric.
- The second window has $N = 63$ and is periodic.

Display the two windows.

```
Hs = sigwin.hann(64, 'symmetric');  
Hp = sigwin.hann(63, 'periodic')
```

```
Hp =  
      Name: 'Hann'  
      SamplingFlag: 'periodic'  
      Length: 63
```

```
wvt = wvtool(Hs, Hp);  
legend(wvt.CurrentAxes, 'Symmetric', 'Periodic')
```

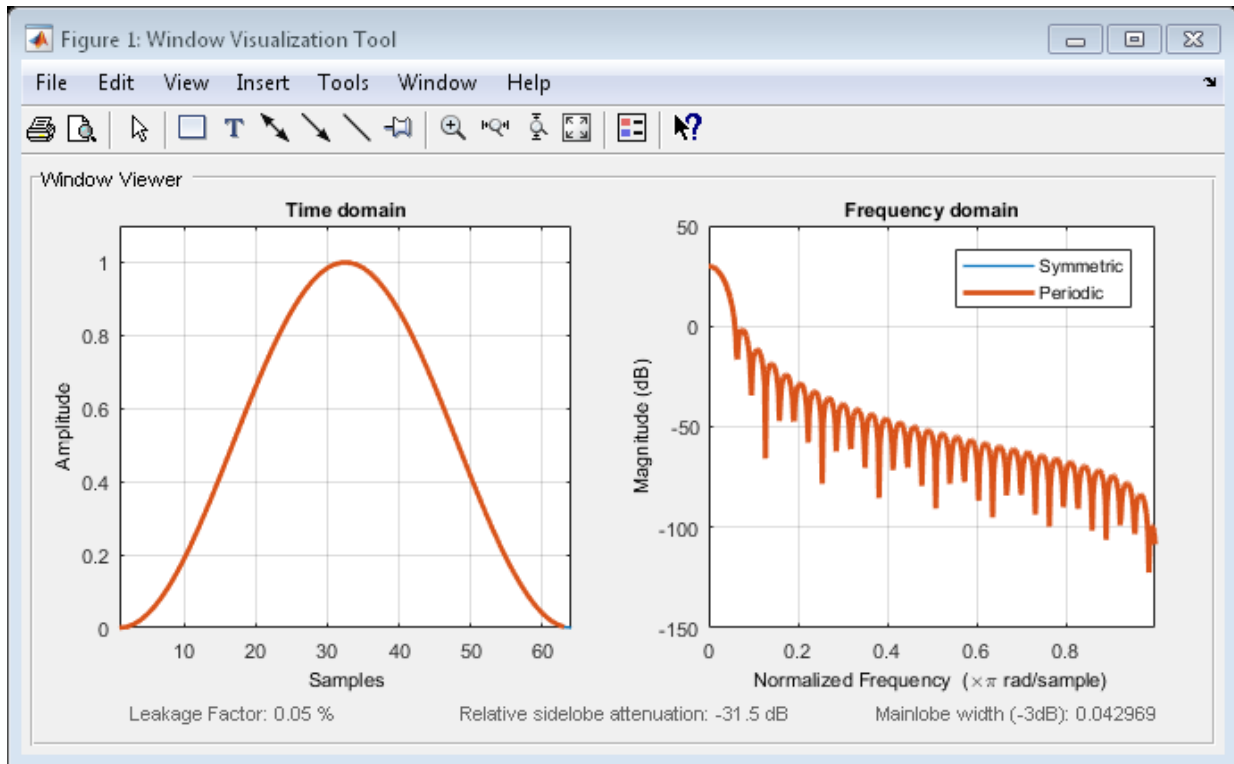
Generate a symmetric Hann window with $N = 16$. Return the window values as a column vector. Write the coefficients to an ASCII file in the current directory. Show information about the window object. Display the window.

```
H = sigwin.hann(16);
```

```
win = generate(H)
```

```
win =
```

```

0
0.0432
0.1654
0.3455
0.5523
0.7500
0.9045
```

```
0.9891
0.9891
0.9045
```

```
winwrite(H, 'hann_16');
wininfo = info(H)
```

```
wininfo = 4x26 char array
'Hann Window'
'-----'
'Length      : 16'
'Sampling Flag : symmetric'
```

```
wvtool(H)
```

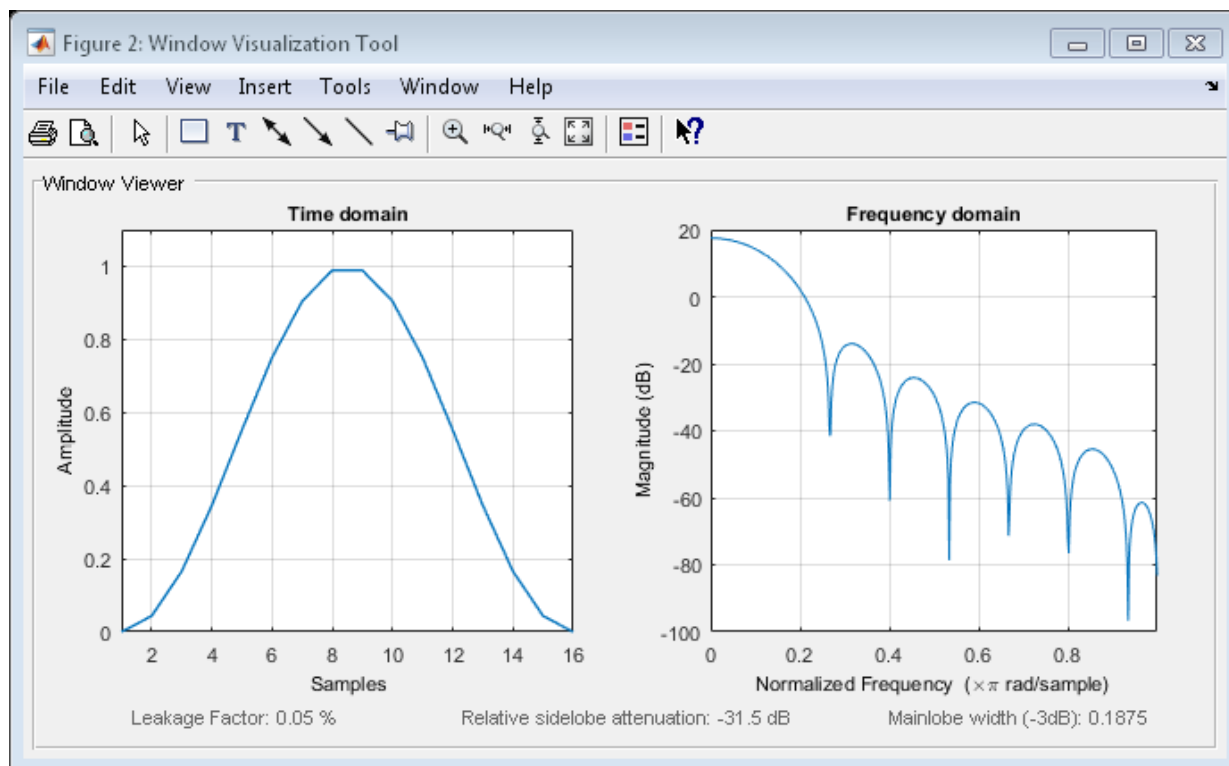

References

Oppenheim, Alan V., and Ronald W. Schaffer. *Discrete-Time Signal Processing*. Upper Saddle River, NJ: Prentice Hall, 1989.

See Also

See Also

hann | window | wvtool

Topics

“Windows”

Class Attributes (MATLAB)

Property Attributes (MATLAB)

generate

Class: sigwin.hann

Package: sigwin

Generates Hann window

Syntax

```
win = generate(H)
```

Description

`win = generate(H)` returns the values of the Hann window object `H` as a double-precision column vector.

Examples

Hann Windows

Generate two Hann windows:

- The first window has $N = 64$ and is symmetric.
- The second window has $N = 63$ and is periodic.

Display the two windows.

```
Hs = sigwin.hann(64, 'symmetric');  
Hp = sigwin.hann(63, 'periodic')
```

```
Hp =  
      Name: 'Hann'  
      SamplingFlag: 'periodic'  
      Length: 63
```

```
wvt = wvtool(Hs, Hp);
```

```
legend(wvt.CurrentAxes, 'Symmetric', 'Periodic')
```

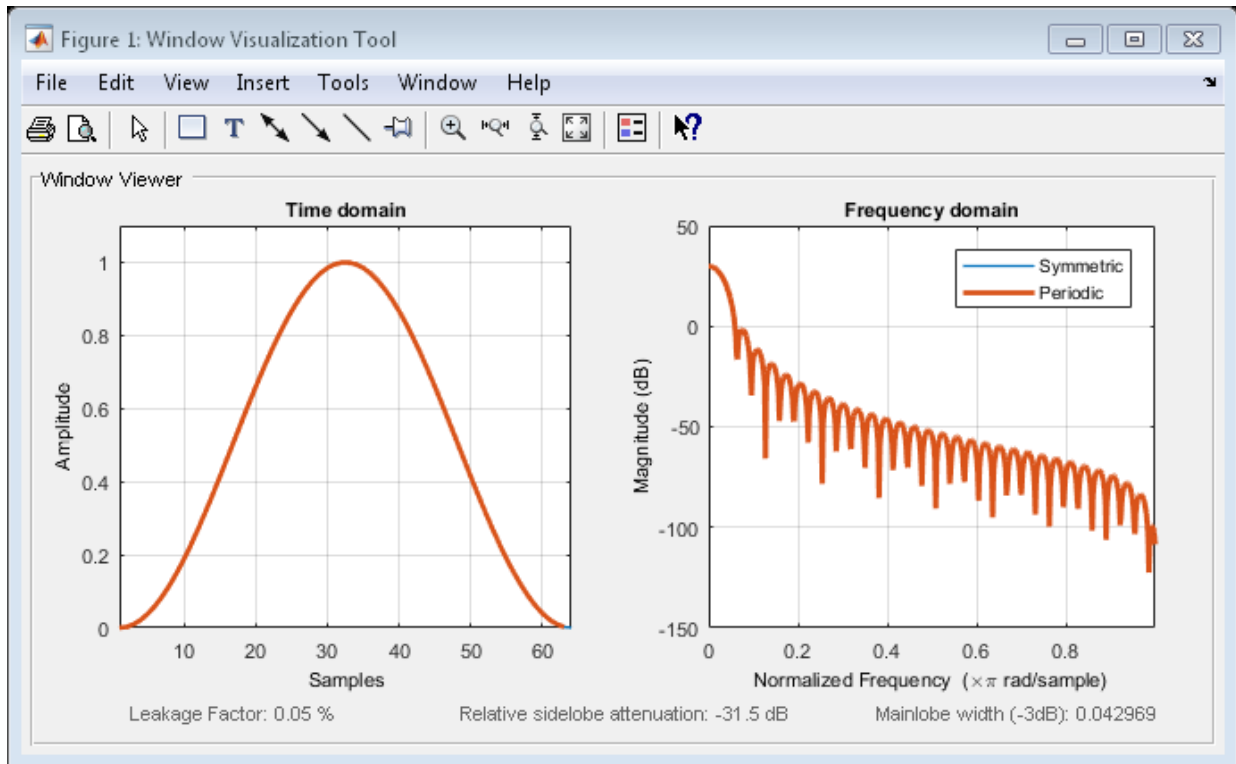

Generate a symmetric Hann window with $N = 16$. Return the window values as a column vector. Write the coefficients to an ASCII file in the current directory. Show information about the window object. Display the window.

```
H = sigwin.hann(16);
```

```
win = generate(H)
```

```
win =
```

```

0
0.0432
0.1654
0.3455
0.5523
```

```
0.7500
0.9045
0.9891
0.9891
0.9045
```

```
winwrite(H,'hann_16');
wininfo = info(H)

wininfo = 4x26 char array
'Hann Window'
'-----'
'Length      : 16'
'Sampling Flag : symmetric'

wvtool(H)
```

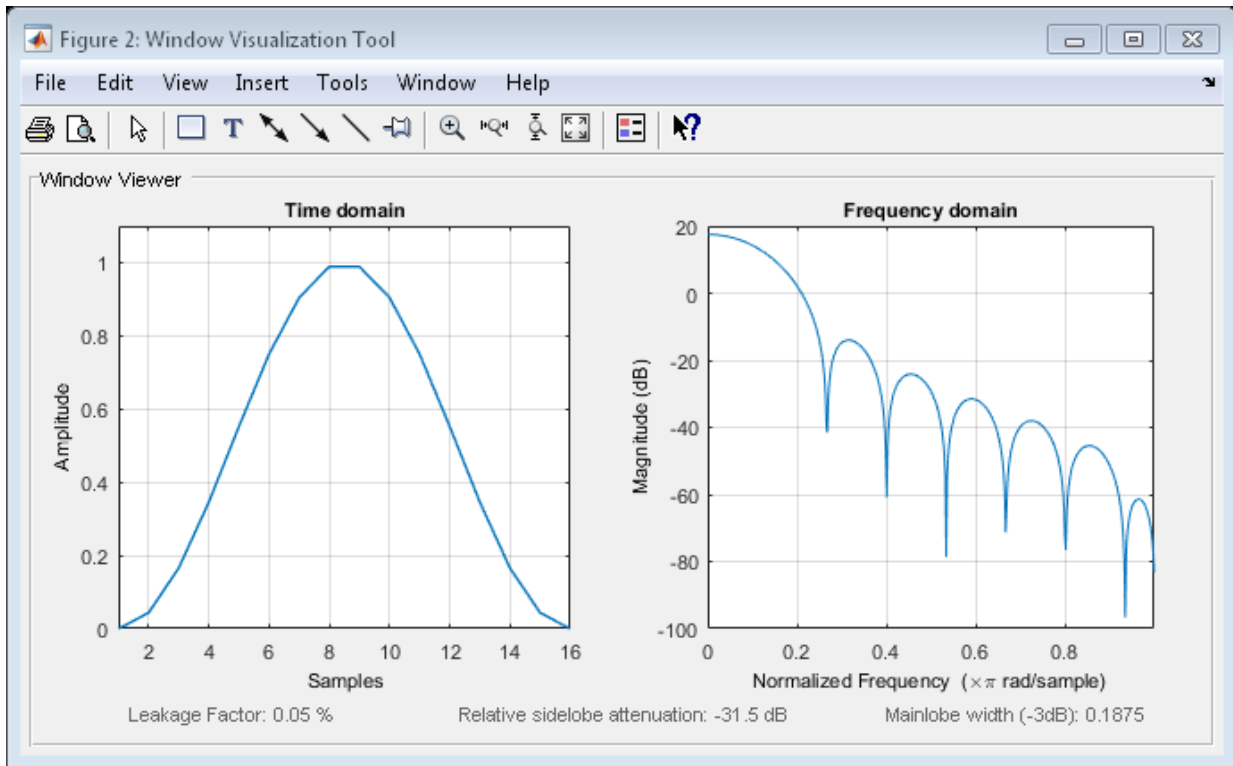

See Also

See Also

[hann](#) | [window](#) | [wvtool](#)

Topics

[“Windows”](#)

[Class Attributes \(MATLAB\)](#)

[Property Attributes \(MATLAB\)](#)

info

Class: sigwin.hann

Package: sigwin

Display information about Hann window object

Syntax

```
info(H)
info_win = info(H)
```

Description

`info(H)` displays length and sampling information for the Hann window object `H`.

`info_win = info(H)` returns length and sampling information for the Hann window object `H` in the character array `info_win`.

Examples

Hann Windows

Generate two Hann windows:

- The first window has $N = 64$ and is symmetric.
- The second window has $N = 63$ and is periodic.

Display the two windows.

```
Hs = sigwin.hann(64, 'symmetric');
Hp = sigwin.hann(63, 'periodic')
```

```
Hp =
      Name: 'Hann'
  SamplingFlag: 'periodic'
      Length: 63
```



```
wvt = wvtool(Hs,Hp);
legend(wvt.CurrentAxes, 'Symmetric', 'Periodic')
```

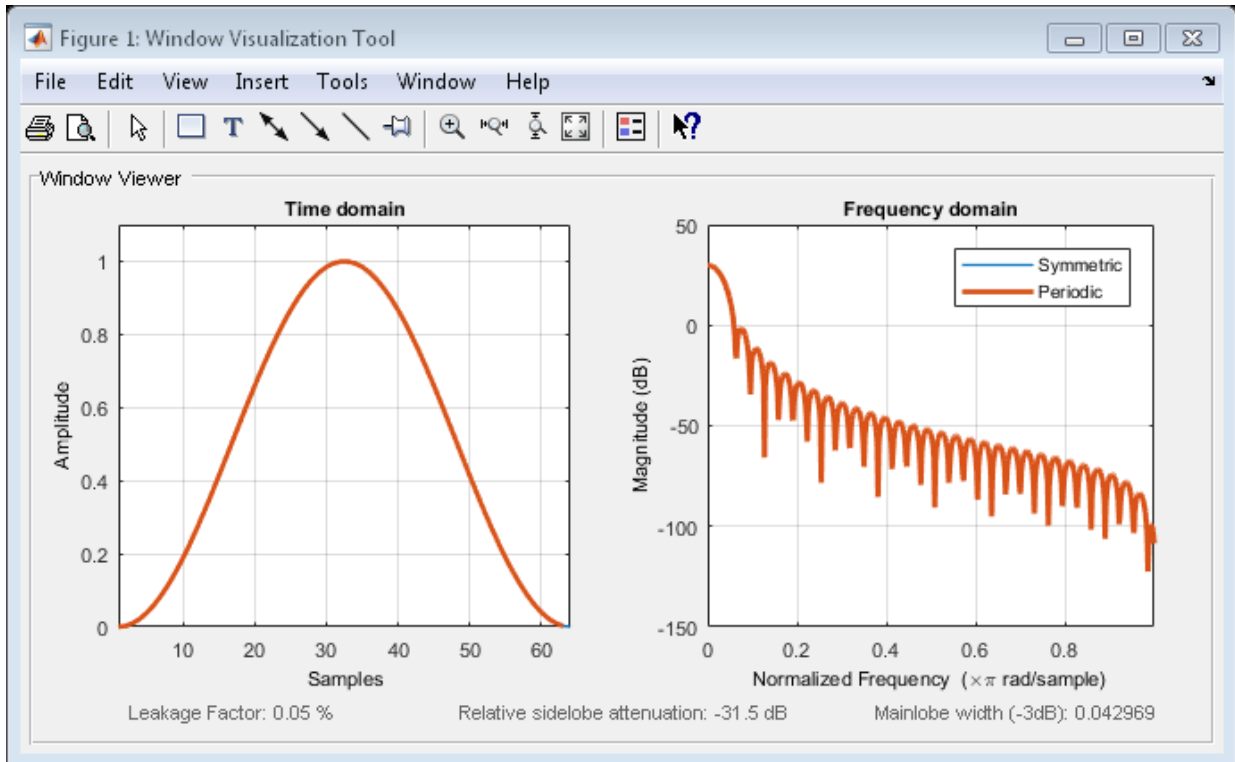

Generate a symmetric Hann window with $N = 16$. Return the window values as a column vector. Write the coefficients to an ASCII file in the current directory. Show information about the window object. Display the window.

```
H = sigwin.hann(16);
```

```
win = generate(H)
```

```
win =
```

```

0
0.0432
0.1654
0.3455
```

```
0.5523
0.7500
0.9045
0.9891
0.9891
0.9045
```

```
winwrite(H, 'hann_16');
wininfo = info(H)

wininfo = 4x26 char array
'Hann Window
-----
'Length      : 16
'Sampling Flag : symmetric'

wvtool(H)
```

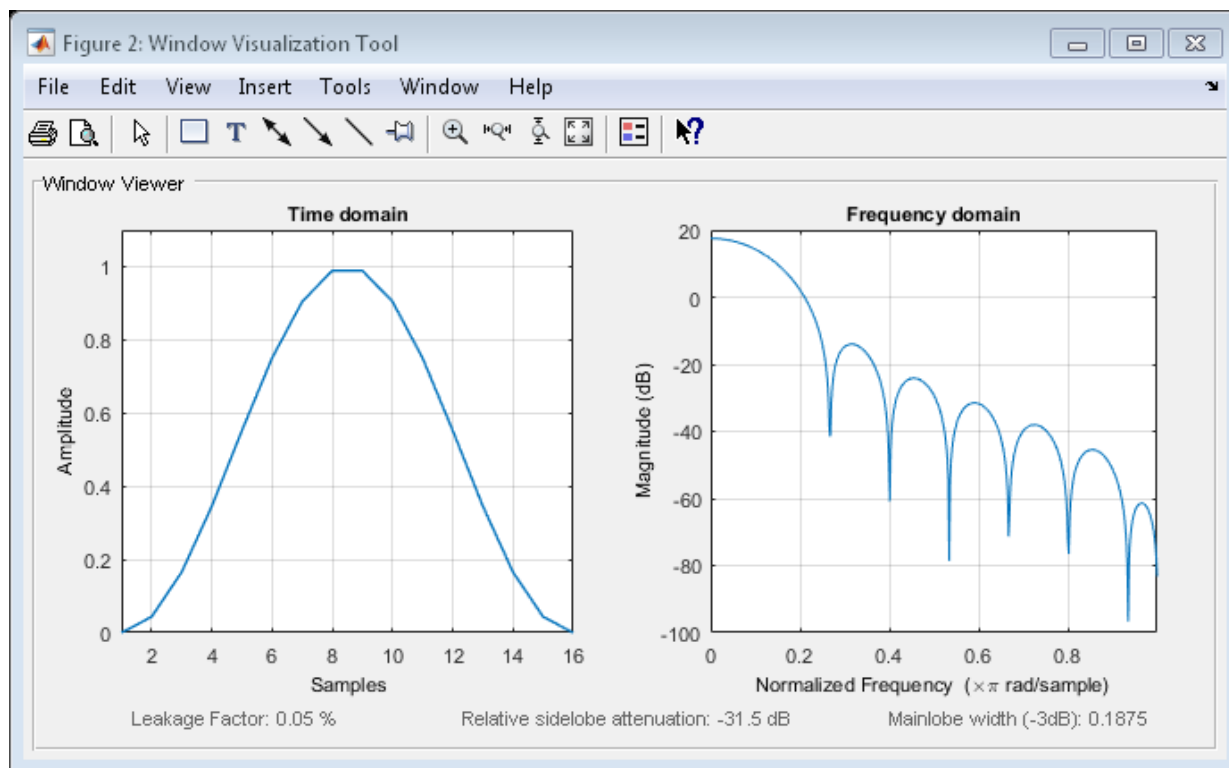

See Also

See Also

[hann](#) | [window](#) | [wvtool](#)

Topics

[“Windows”](#)

[Class Attributes \(MATLAB\)](#)

[Property Attributes \(MATLAB\)](#)

winwrite

Class: sigwin.hann

Package: sigwin

Save Hann window object values in ASCII file

Syntax

```
winwrite(H)
winwrite(H, 'filename')
```

Description

`winwrite(H)` opens a dialog to export the values of the Hann window object `H` to an ASCII file. The file extension `.wf` is automatically appended.

`winwrite(H, 'filename')` saves the values of the Hann window object `H` in the current folder as a column vector in the ASCII file `'filename'`. The file extension `.wf` is automatically appended to `filename`.

Examples

Hann Windows

Generate two Hann windows:

- The first window has $N = 64$ and is symmetric.
- The second window has $N = 63$ and is periodic.

Display the two windows.

```
Hs = sigwin.hann(64, 'symmetric');
Hp = sigwin.hann(63, 'periodic')
```

```
Hp =
```

```
Name: 'Hann'
SamplingFlag: 'periodic'
Length: 63
```

```
wvt = wvtool(Hs,Hp);
legend(wvt.CurrentAxes,'Symmetric','Periodic')
```

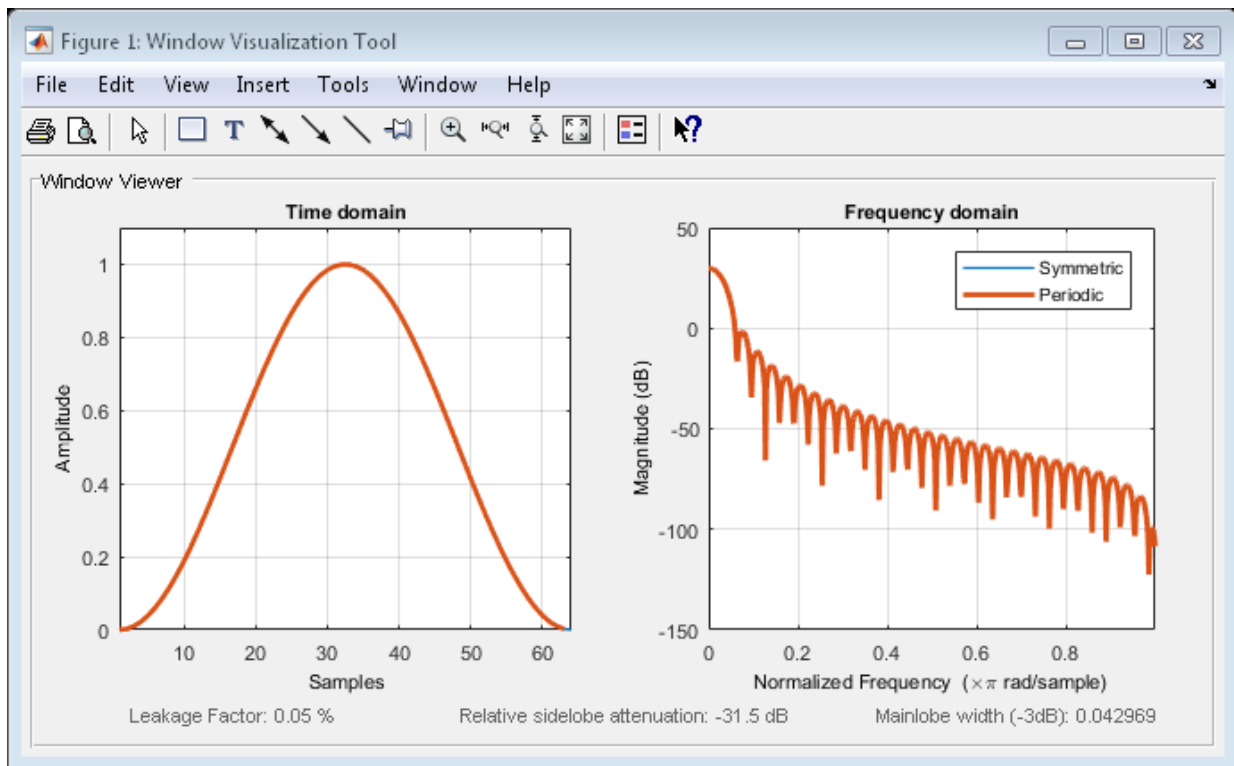

Generate a symmetric Hann window with $N = 16$. Return the window values as a column vector. Write the coefficients to an ASCII file in the current directory. Show information about the window object. Display the window.

```
H = sigwin.hann(16);
win = generate(H)
```

```
win =  
  
    0  
    0.0432  
    0.1654  
    0.3455  
    0.5523  
    0.7500  
    0.9045  
    0.9891  
    0.9891  
    0.9045  
  
winwrite(H, 'hann_16');  
wininfo = info(H)  
  
wininfo = 4×26 char array  
    'Hann Window           '  
    '-----             '  
    'Length       : 16     '  
    'Sampling Flag : symmetric'
```

wvtool(H)

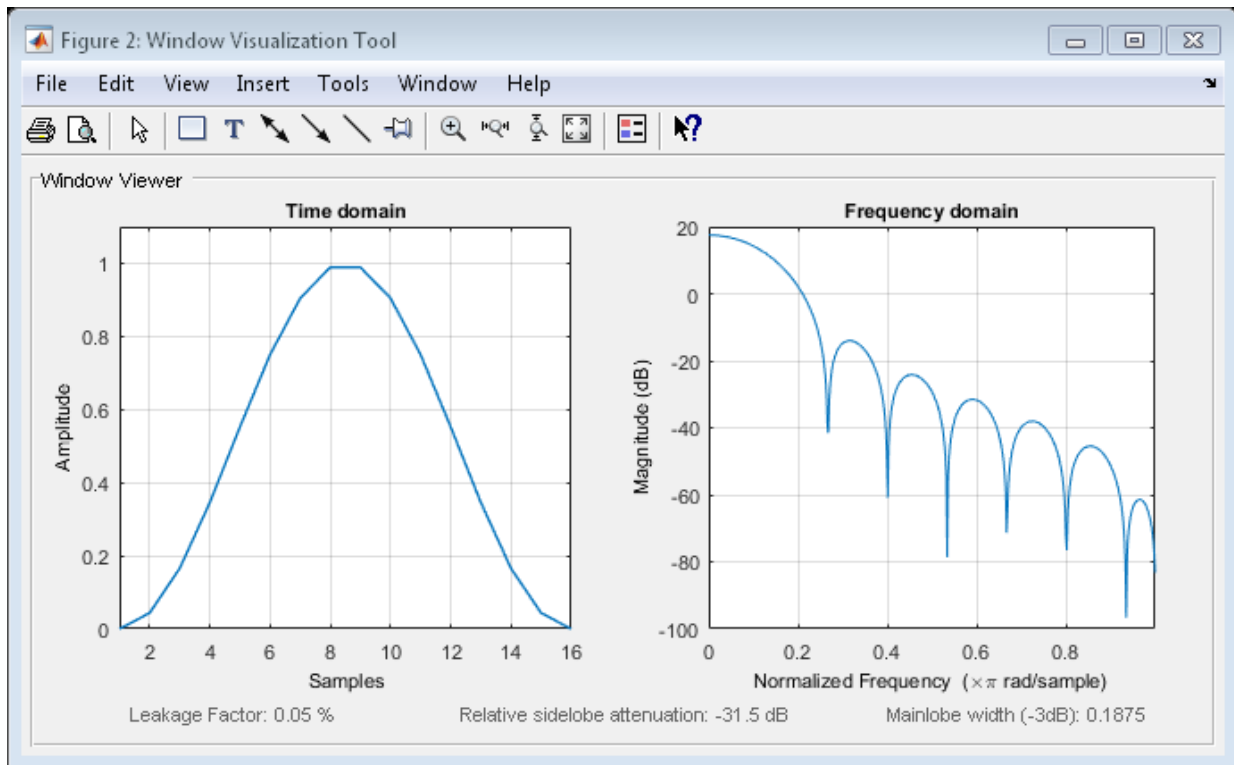

See Also

See Also

`hann` | `window` | `wvtool`

Topics

“Windows”

Class Attributes (MATLAB)

Property Attributes (MATLAB)

sigwin.kaiser class

Package: sigwin

Construct Kaiser window object

Description

Note: The use of `sigwin.kaiser` is not recommended. Use `kaiser` instead.

`sigwin.kaiser` creates a handle to a Kaiser window object for use in spectral analysis and FIR filtering by the `window` method. Object methods enable workspace import and ASCII file export of the window values.

The following equation defines the Kaiser window of length N :

$$w(x) = I_0\left(\beta\sqrt{1 - \frac{4x^2}{(N-1)^2}}\right) / I_0(\beta), \quad -(N-1)/2 \leq x \leq (N-1)/2$$

where x is linearly spaced N -point vector and $I_0()$ is the modified zero-th order Bessel function of the first kind. β is the attenuation parameter.

Construction

`H = sigwin.kaiser` returns a Kaiser window object `H` of length 64 and attenuation parameter `beta` of 0.5.

`H = sigwin.kaiser(Length)` returns a Kaiser window object `H` of length `Length` and attenuation parameter `beta` of 0.5. `Length` requires a positive integer. Entering a positive noninteger value for `Length` rounds the length to the nearest integer. Entering a 1 for `Length` results in a window with a single value of 1.

`H = sigwin.kaiser(Length, Beta)` returns a Kaiser window object with real-valued attenuation parameter `beta`.

Properties

Length

Kaiser window length. The window length requires a positive integer. Entering a positive noninteger value for *Length* rounds the length to the nearest integer. Entering a 1 for *Length* results in a window with a single value of 1.

Beta

Attenuation parameter. **Beta** requires a real number. Larger absolute values of **Beta** result in greater stopband attenuation, or equivalently greater attenuation between the main lobe and first side lobe.

Methods

generate	Generates Kaiser window
info	Display information about Kaiser window object
winwrite	Save Kaiser window in ASCII file

Copy Semantics

Handle. To learn how copy semantics affect your use of the class, see Copying Objects (MATLAB) in the MATLAB Programming Fundamentals documentation.

Examples

Kaiser Windows

Generate two Kaiser windows of length $N = 64$:

- The first window has an attenuation parameter $\beta = 5$.

- The second window has $\beta = 15$.

Display the two windows.

```
H05 = sigwin.kaiser(128,5);
H15 = sigwin.kaiser(128,15);

wvt = wvtool(H05,H15);
legend(wvt.CurrentAxes, '\beta = 5', '\beta = 15')
```

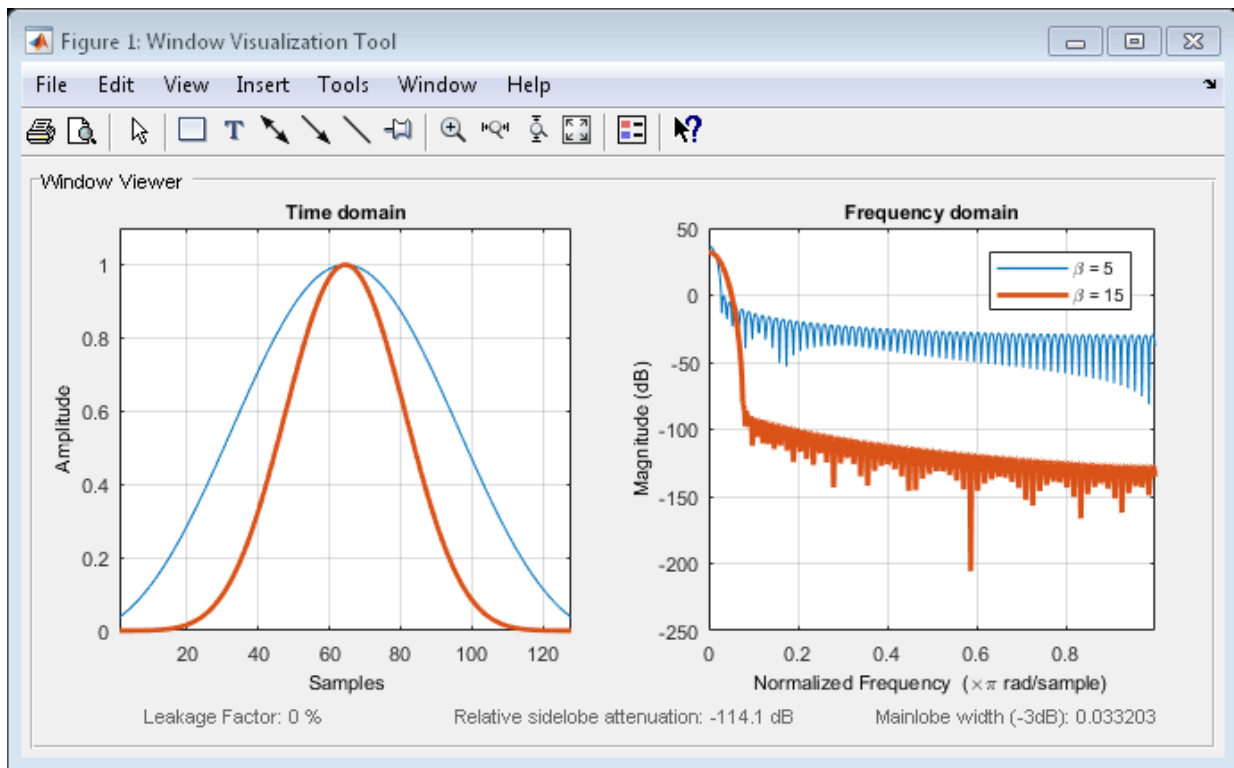

Generate a Kaiser window with length $N = 16$ and the default $\beta = 1/2$. Return its values as a column vector. Write the coefficients to an ASCII file in the current directory. Show information about the window object. Display the window.

```
H = sigwin.kaiser(16);
```

```
win = generate(H)

win =

    0.9403
    0.9550
    0.9677
    0.9783
    0.9868
    0.9933
    0.9976
    0.9997
    0.9997
    0.9976

winwrite(H, 'kaiser_16');
wininfo = info(H)

wininfo = 4x13 char array
    'Kaiser Window'
    '-----'
    'Length   : 16 '
    'Beta     : 0.5'
```

```
wvtool(H)
```

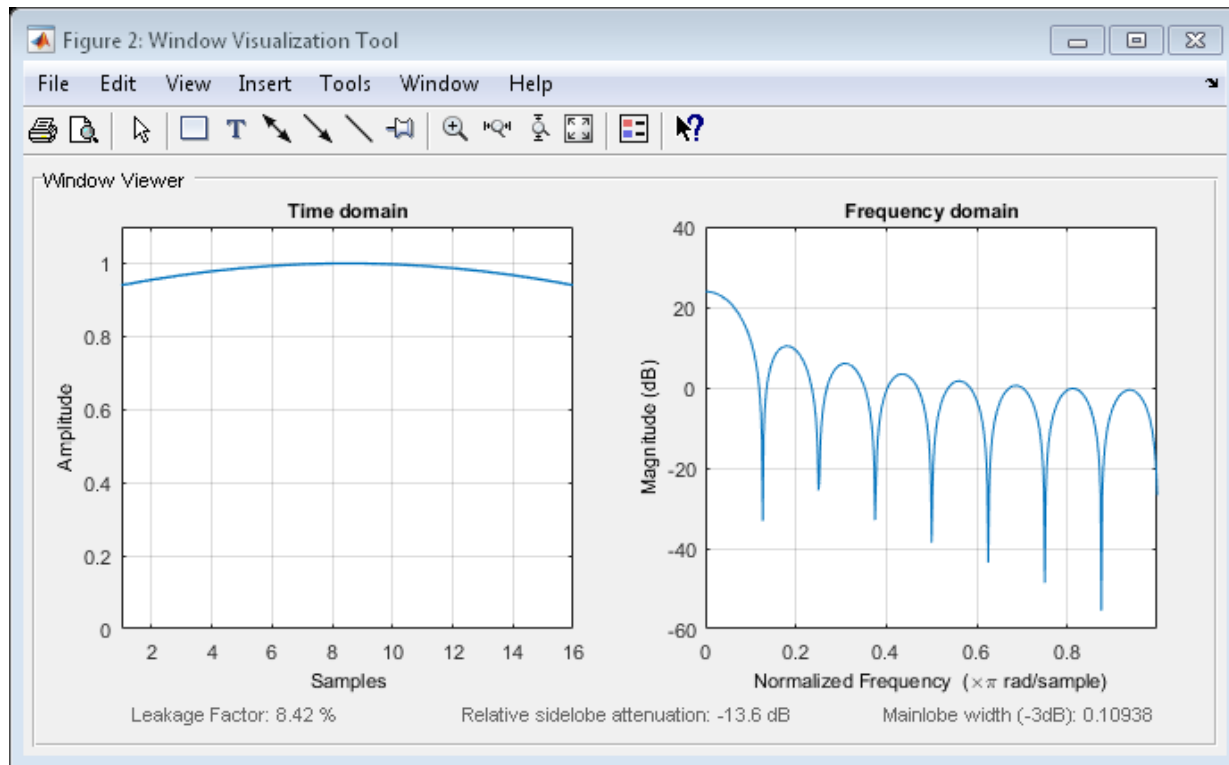

References

Oppenheim, Alan V., and Ronald W. Schaffer. *Discrete-Time Signal Processing*. Upper Saddle River, NJ: Prentice Hall, 1989.

See Also

See Also

kaiser | window | wvtool

Topics

“Windows”

Class Attributes (MATLAB)

Property Attributes (MATLAB)

generate

Class: sigwin.kaiser

Package: sigwin

Generates Kaiser window

Syntax

```
win = generate(H)
```

Description

`win = generate(H)` returns the values of the Kaiser window object as a double-precision column vector.

Examples

Kaiser Windows

Generate two Kaiser windows of length $N = 64$:

- The first window has an attenuation parameter $\beta = 5$.
- The second window has $\beta = 15$.

Display the two windows.

```
H05 = sigwin.kaiser(128,5);  
H15 = sigwin.kaiser(128,15);  
  
wvt = wvtool(H05,H15);  
legend(wvt.CurrentAxes, '\beta = 5', '\beta = 15')
```

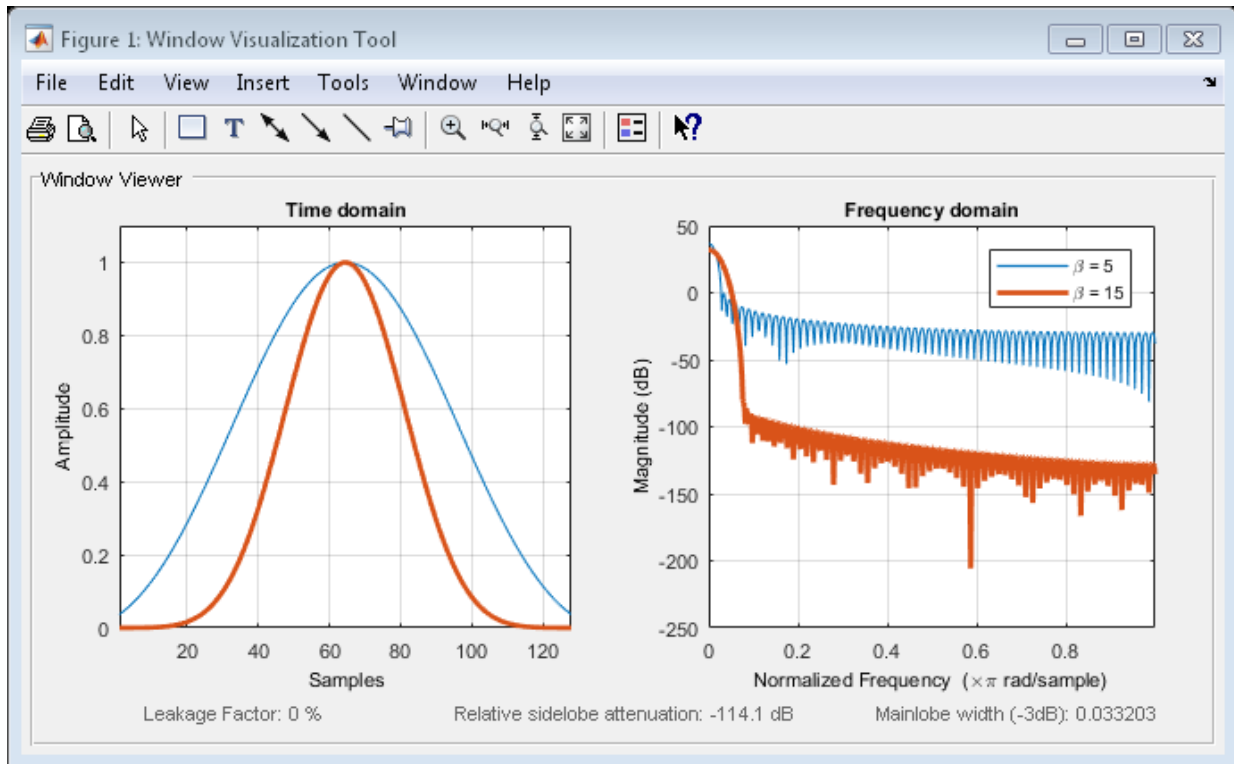

Generate a Kaiser window with length $N = 16$ and the default $\beta = 1/2$. Return its values as a column vector. Write the coefficients to an ASCII file in the current directory. Show information about the window object. Display the window.

```
H = sigwin.kaiser(16);
```

```
win = generate(H)
```

```
win =
```

```
0.9403
0.9550
0.9677
0.9783
0.9868
0.9933
0.9976
```

```
0.9997
0.9997
0.9976
```

```
winwrite(H, 'kaiser_16');
wininfo = info(H)
```

```
wininfo = 4x13 char array
'Kaiser Window'
'-----'
'Length   : 16 '
'Beta     : 0.5'
```

```
wvtool(H)
```

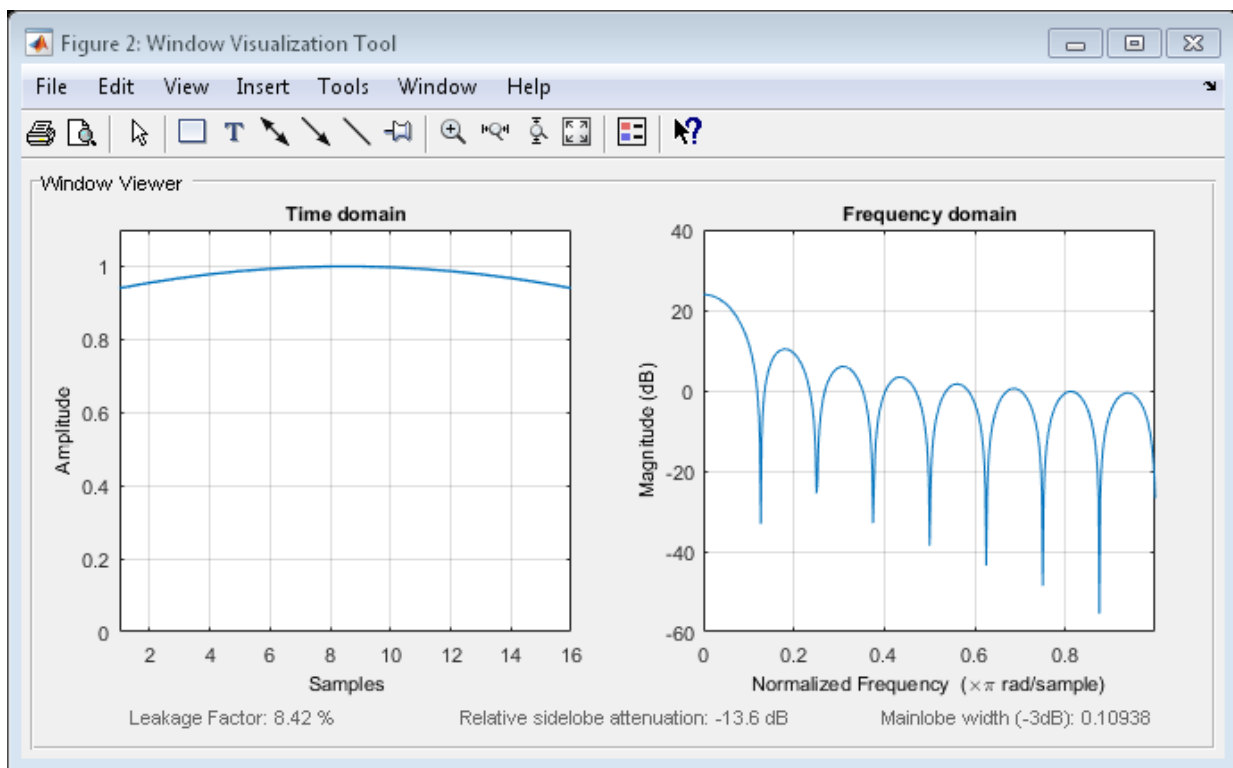

See Also

See Also

kaiser | window | wvtool

Topics

“Windows”

Class Attributes (MATLAB)

Property Attributes (MATLAB)

info

Class: sigwin.kaiser

Package: sigwin

Display information about Kaiser window object

Syntax

```
info(H)
info_win = info(H)
```

Description

`info(H)` displays length and attenuation information for the Kaiser window object `H`.

`info_win = info(H)` returns length and attenuation information for the Kaiser window object `H` in the character array `info_win`.

Examples

Kaiser Windows

Generate two Kaiser windows of length $N = 64$:

- The first window has an attenuation parameter $\beta = 5$.
- The second window has $\beta = 15$.

Display the two windows.

```
H05 = sigwin.kaiser(128,5);
H15 = sigwin.kaiser(128,15);

wvt = wvtool(H05,H15);
legend(wvt.CurrentAxes, '\beta = 5', '\beta = 15')
```

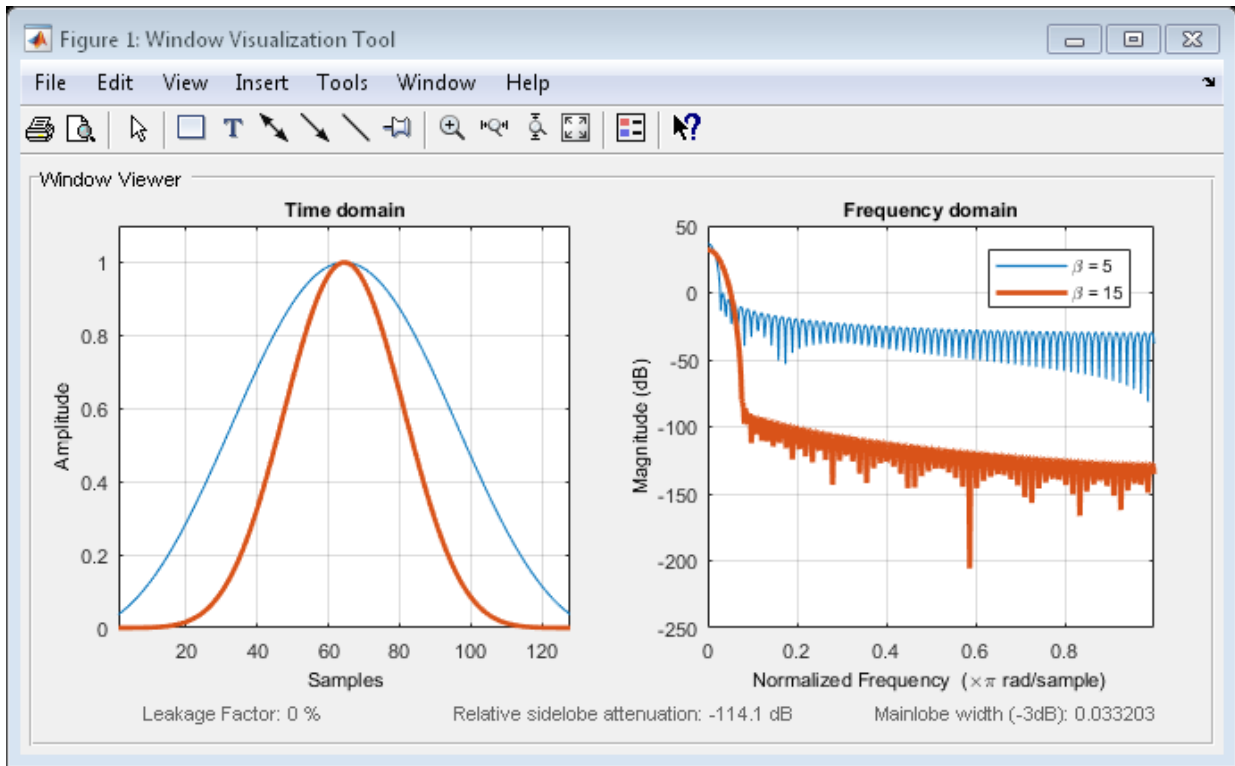

Generate a Kaiser window with length $N = 16$ and the default $\beta = 1/2$. Return its values as a column vector. Write the coefficients to an ASCII file in the current directory. Show information about the window object. Display the window.

```
H = sigwin.kaiser(16);
```

```
win = generate(H)
```

```
win =
```

```
0.9403
0.9550
0.9677
0.9783
0.9868
0.9933
0.9976
```

```
0.9997
0.9997
0.9976
```

```
winwrite(H, 'kaiser_16');
wininfo = info(H)
```

```
wininfo = 4x13 char array
'Kaiser Window'
'-----'
'Length   : 16  '
'Beta     : 0.5  '
```

```
wvtool(H)
```

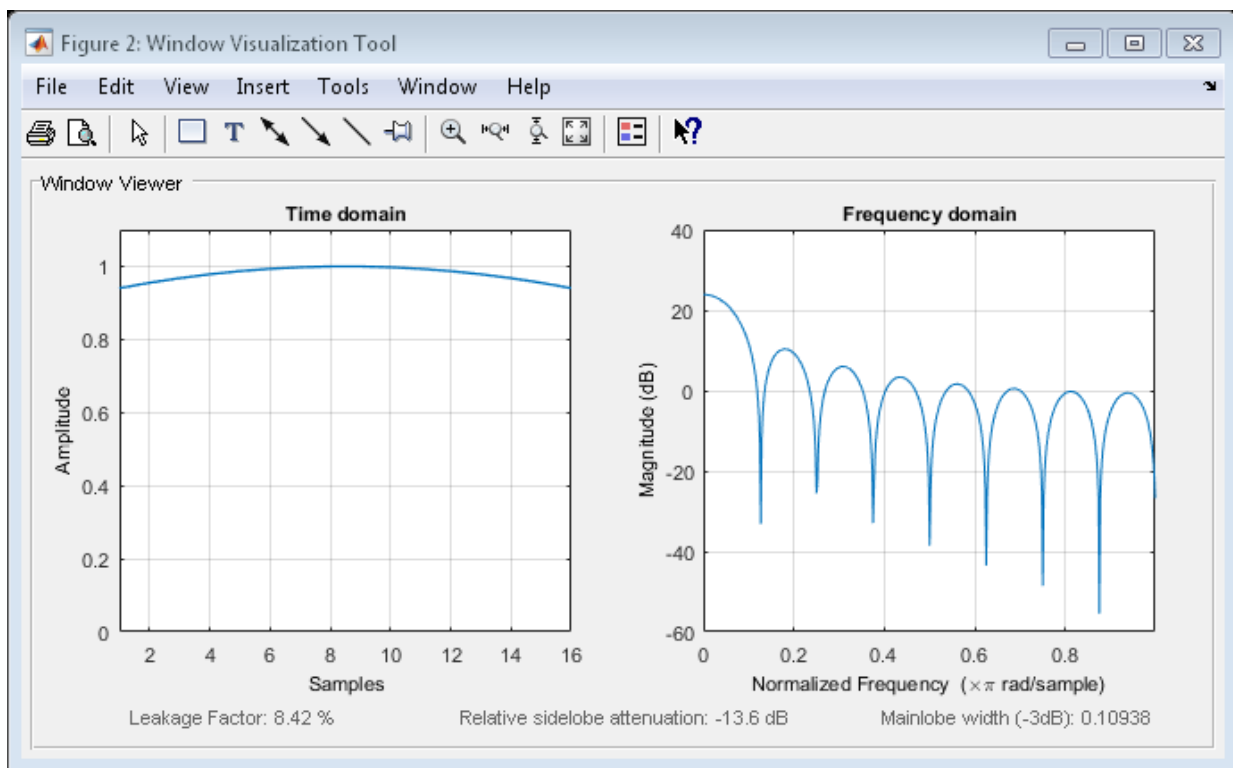

See Also

See Also

kaiser | window | wvtool

Topics

“Windows”

Class Attributes (MATLAB)

Property Attributes (MATLAB)

winwrite

Class: sigwin.kaiser

Package: sigwin

Save Kaiser window in ASCII file

Syntax

```
winwrite(H)  
winwrite(H, 'filename')
```

Description

`winwrite(H)` opens a dialog to export the Kaiser window values to an ASCII file. The file extension `.wf` is automatically appended.

`winwrite(H, 'filename')` saves the values of the Kaiser window object `H` in the current folder as a column vector in the ASCII file `'filename'`. The file extension `.wf` is automatically appended to `filename`.

Examples

Kaiser Windows

Generate two Kaiser windows of length $N = 64$:

- The first window has an attenuation parameter $\beta = 5$.
- The second window has $\beta = 15$.

Display the two windows.

```
H05 = sigwin.kaiser(128,5);  
H15 = sigwin.kaiser(128,15);  
  
wvt = wvtool(H05,H15);
```

```
legend(wvt.CurrentAxes, '\beta = 5', '\beta = 15')
```

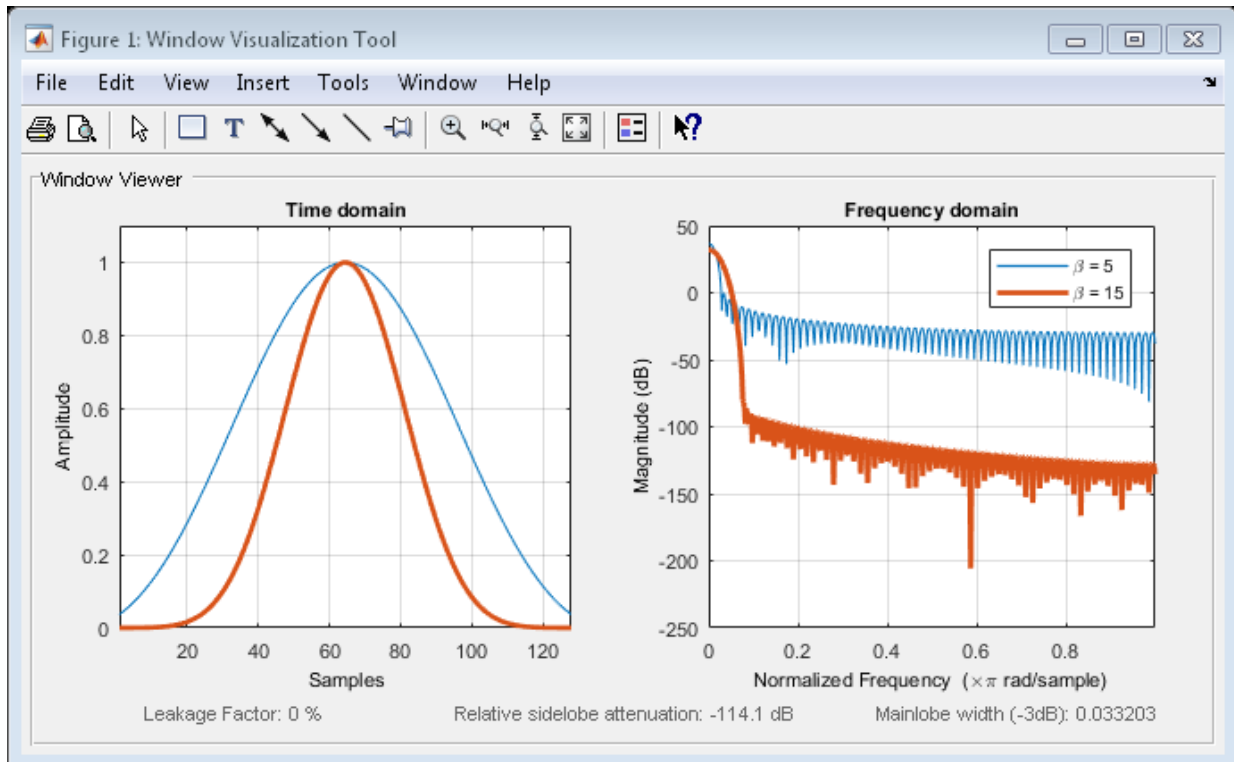

Generate a Kaiser window with length $N = 16$ and the default $\beta = 1/2$. Return its values as a column vector. Write the coefficients to an ASCII file in the current directory. Show information about the window object. Display the window.

```
H = sigwin.kaiser(16);
```

```
win = generate(H)
```

```
win =
```

```
0.9403
0.9550
0.9677
0.9783
0.9868
```

```
0.9933
0.9976
0.9997
0.9997
0.9976
```

```
winwrite(H,'kaiser_16');
wininfo = info(H)
```

```
wininfo = 4×13 char array
    'Kaiser Window'
    '-----'
    'Length   : 16'
    'Beta    : 0.5'
```

```
wvtool(H)
```

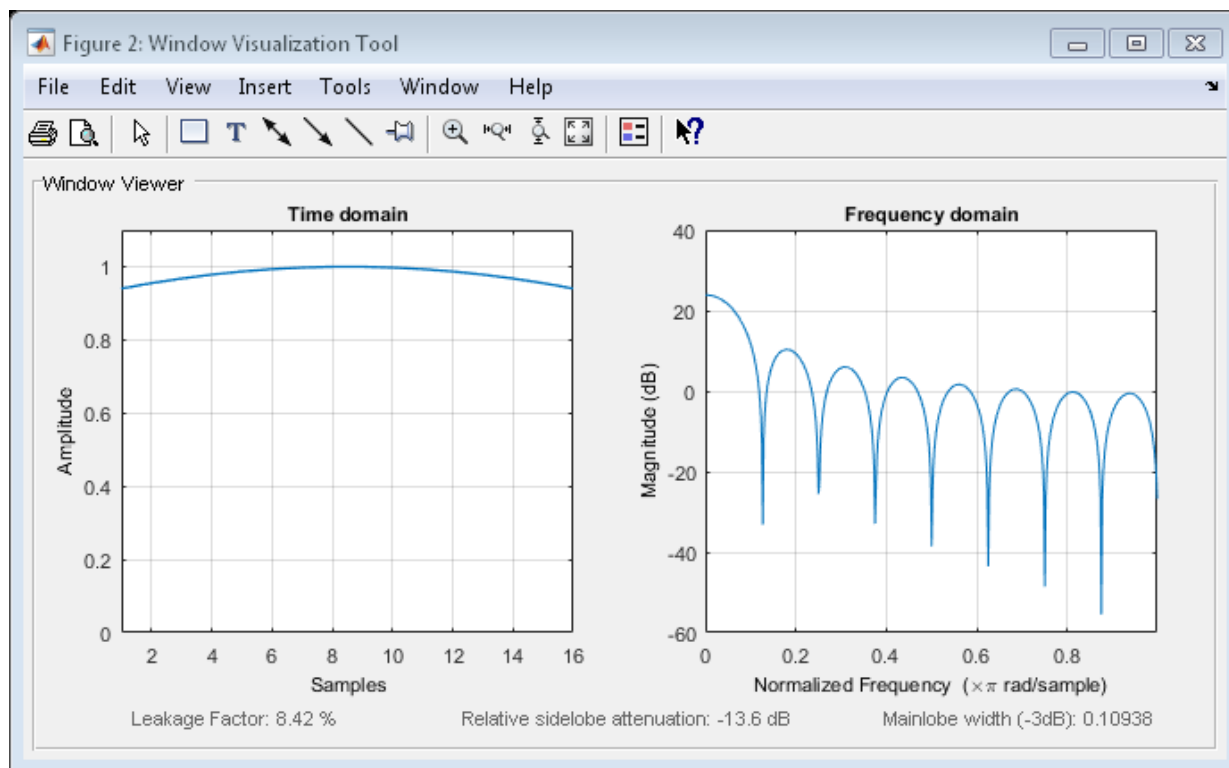

See Also

See Also

kaiser | window | wvtool

Topics

“Windows”

Class Attributes (MATLAB)

Property Attributes (MATLAB)

sigwin.nuttallwin class

Package: sigwin

Construct Nuttall defined four-term Blackman-Harris window object

Description

Note: The use of `sigwin.nuttallwin` is not recommended. Use `nuttallwin` instead.

`sigwin.nuttallwin` creates a handle to a Nuttall defined four-term Blackman-Harris window object for use in spectral analysis and FIR filtering by the `window` method. Object methods enable workspace import and ASCII file export of the window values.

Construction

`H = sigwin.nuttallwin` returns a Nuttall defined four-term Blackman-Harris window object `H` of length 64.

`H = sigwin.nuttallwin(Length)` returns a Nuttall defined four-term Blackman-Harris window object `H` of length `Length`. Entering a positive noninteger value for `Length` rounds the length to the nearest integer. Entering a 1 for `Length` results in a window with a single value of 1. The `SamplingFlag` property defaults to `'symmetric'`.

Properties

Length

Nuttall defined four-term Blackman-Harris window length. The window length must be a positive integer. Entering a positive noninteger value for `Length` rounds the length to the nearest integer. Entering a 1 for `Length` results in a window with a single value of 1.

SamplingFlag

The type of window returned as one of `'symmetric'` or `'periodic'`. The default is `'symmetric'`. A symmetric window exhibits perfect symmetry between halves of the

window. Setting the `SamplingFlag` property to `'periodic'` results in a N -periodic window. The equations for the Nuttall defined 4-term Blackman-Harris window differ slightly based on the value of the `SamplingFlag` property. See “Algorithms” on page 1-2032 for details.

Methods

<code>generate</code>	Generates Nuttall defined four-term Blackman-Harris window
<code>info</code>	Display information about Nuttall defined four-term Blackman-Harris window object
<code>winwrite</code>	Save Nuttall defined four-term Blackman-Harris window object values in ASCII file

Copy Semantics

Handle. To learn how copy semantics affect your use of the class, see Copying Objects (MATLAB) in the MATLAB Programming Fundamentals documentation.

Examples

Nuttall-Defined Four-Term Blackman-Harris Windows

Generate two Nuttall-defined four-term Blackman-Harris windows:

- The first window has $N = 64$ and is symmetric.
- The second window has $N = 63$ and is periodic.

Display the two windows.

```
Hs = sigwin.nuttallwin(64);
Hp = sigwin.nuttallwin(63);
Hp.SamplingFlag = 'periodic';

wvt = wvtool(Hs, Hp);
```

```
legend(wvt.CurrentAxes, 'Symmetric', 'Periodic')
```

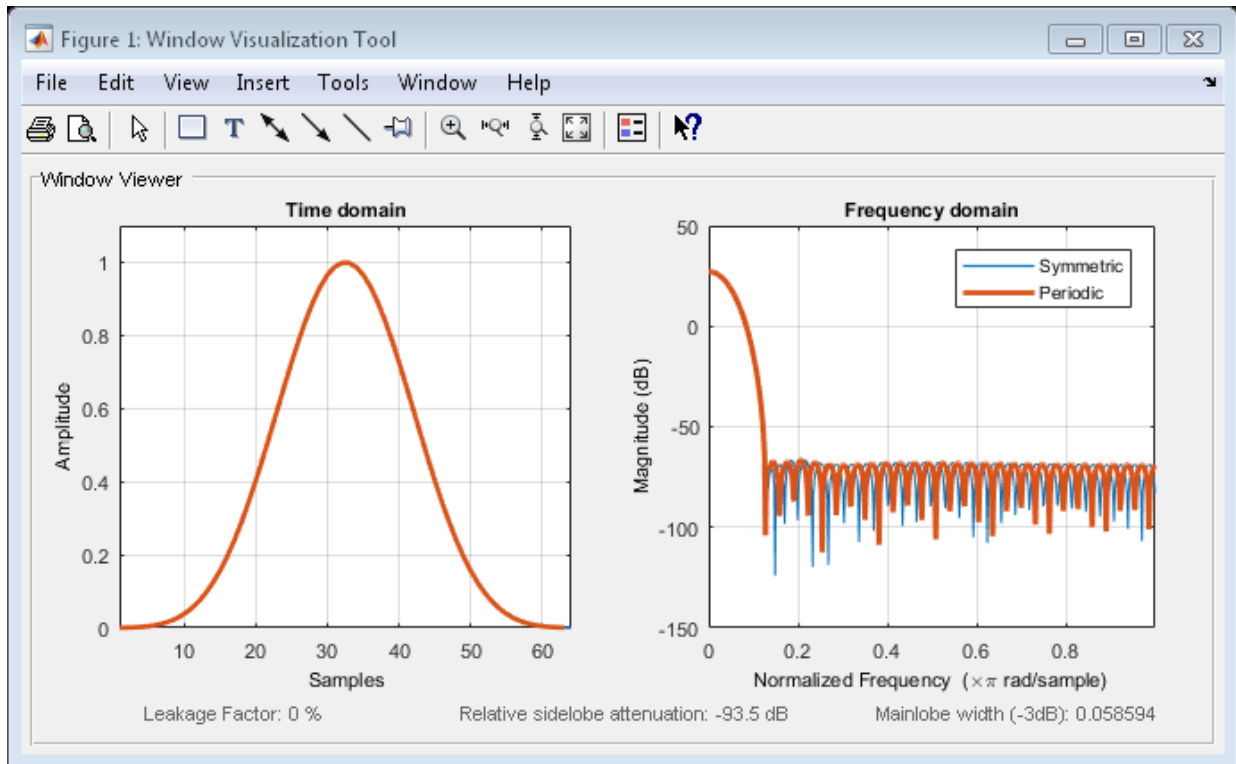

Generate a symmetric Nuttall-defined four-term Blackman-Harris window with $N = 16$. Return the window values as a column vector. Write the coefficients to an ASCII file in the current directory. Show information about the window object. Display the window.

```
H = sigwin.nuttallwin(16);
```

```
win = generate(H)
```

```
win =
```

```
0.0004
0.0048
0.0306
0.1105
0.2778
```

```

0.5292
0.7983
0.9755
0.9755
0.7983

```

```

winwrite(H,'nuttallwin_16');
wininfo = info(H)

```

```

wininfo = 4x26 char array
    'Nuttall Window'
    '-----'
    'Length       : 16'
    'Sampling Flag : symmetric'

```

```

wvtool(H)

```

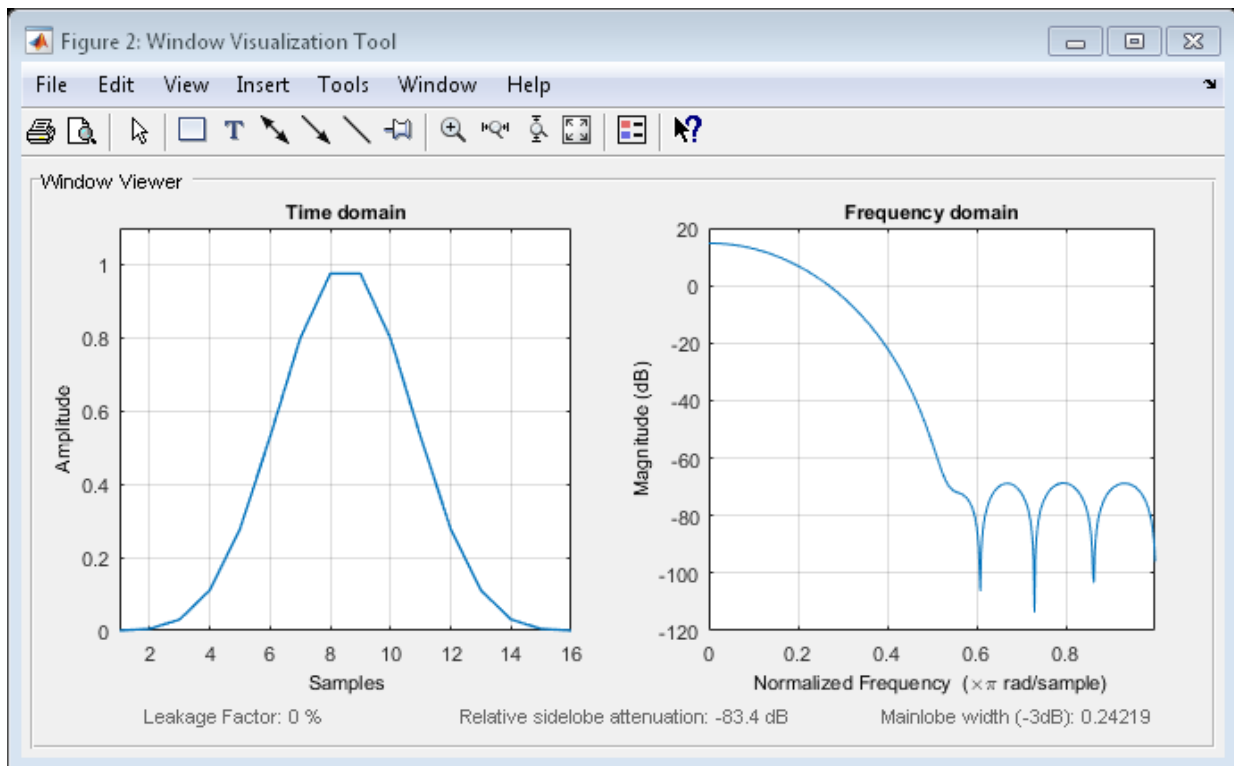

Algorithms

The following equation defines the symmetric Nuttall defined four-term Blackman-Harris window of length N .

$$w(n) = a_0 - a_1 \cos\left(\frac{2\pi n}{N-1}\right) + a_2 \cos\left(\frac{4\pi n}{N-1}\right) - a_3 \cos\left(\frac{6\pi n}{N-1}\right), \quad 0 \leq n \leq N-1$$

The following equation defines the periodic Nuttall defined four-term Blackman-Harris window of length N .

$$w(n) = a_0 - a_1 \cos\frac{2\pi n}{N} + a_2 \cos\frac{4\pi n}{N} - a_3 \cos\frac{6\pi n}{N}, \quad 0 \leq n \leq N-1$$

The following table lists the coefficients:

Coefficient	Value
a_0	0.3635819
a_1	0.4891775
a_2	0.1365995
a_3	0.0106411

References

Nuttall, A. H. "Some Windows with Very Good Sidelobe Behavior." *IEEE Transactions on Acoustics, Speech, and Signal Processing*. Vol. 29, 1981, pp. 84–91.

See Also

See Also

nuttallwin | window | wvtool

Topics

“Windows”

Class Attributes (MATLAB)

Property Attributes (MATLAB)

generate

Class: sigwin.nuttallwin

Package: sigwin

Generates Nuttall defined four-term Blackman-Harris window

Syntax

```
win = generate(H)
```

Description

`win = generate(H)` returns the values of the Nuttall defined four-term Blackman-Harris window object as a double-precision column vector.

Examples

Nuttall-Defined Four-Term Blackman-Harris Windows

Generate two Nuttall-defined four-term Blackman-Harris windows:

- The first window has $N = 64$ and is symmetric.
- The second window has $N = 63$ and is periodic.

Display the two windows.

```
Hs = sigwin.nuttallwin(64);  
Hp = sigwin.nuttallwin(63);  
Hp.SamplingFlag = 'periodic';  
  
wvt = wvtool(Hs, Hp);  
legend(wvt.CurrentAxes, 'Symmetric', 'Periodic')
```

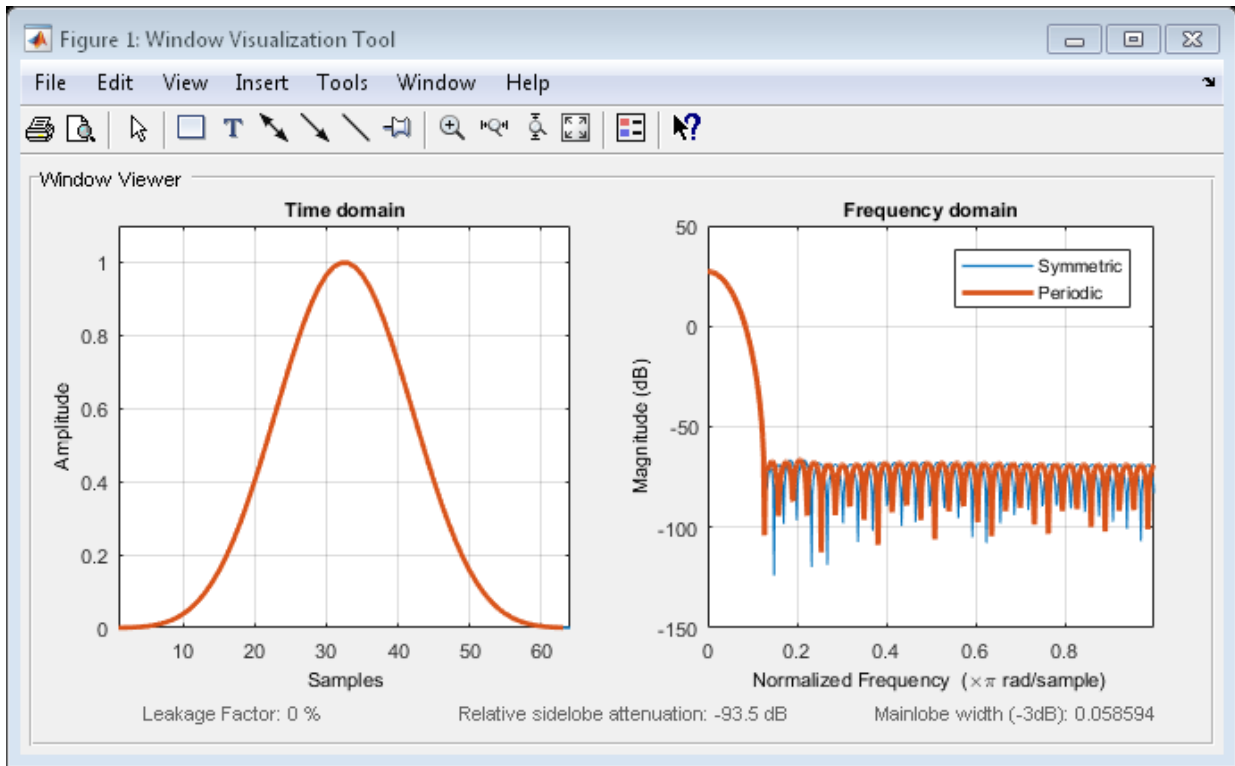
Generate a symmetric Nuttall-defined four-term Blackman-Harris window with $N = 16$. Return the window values as a column vector. Write the coefficients to an ASCII file in the current directory. Show information about the window object. Display the window.

```
H = sigwin.nuttallwin(16);
```

```
win = generate(H)
```

```
win =
```

```
0.0004
0.0048
0.0306
0.1105
0.2778
0.5292
0.7983
```

```

0.9755
0.9755
0.7983

winwrite(H, 'nuttallwin_16');
wininfo = info(H)

wininfo = 4x26 char array
    'Nuttall Window'
    '-----'
    'Length       : 16'
    'Sampling Flag : symmetric'

wvtool(H)

```

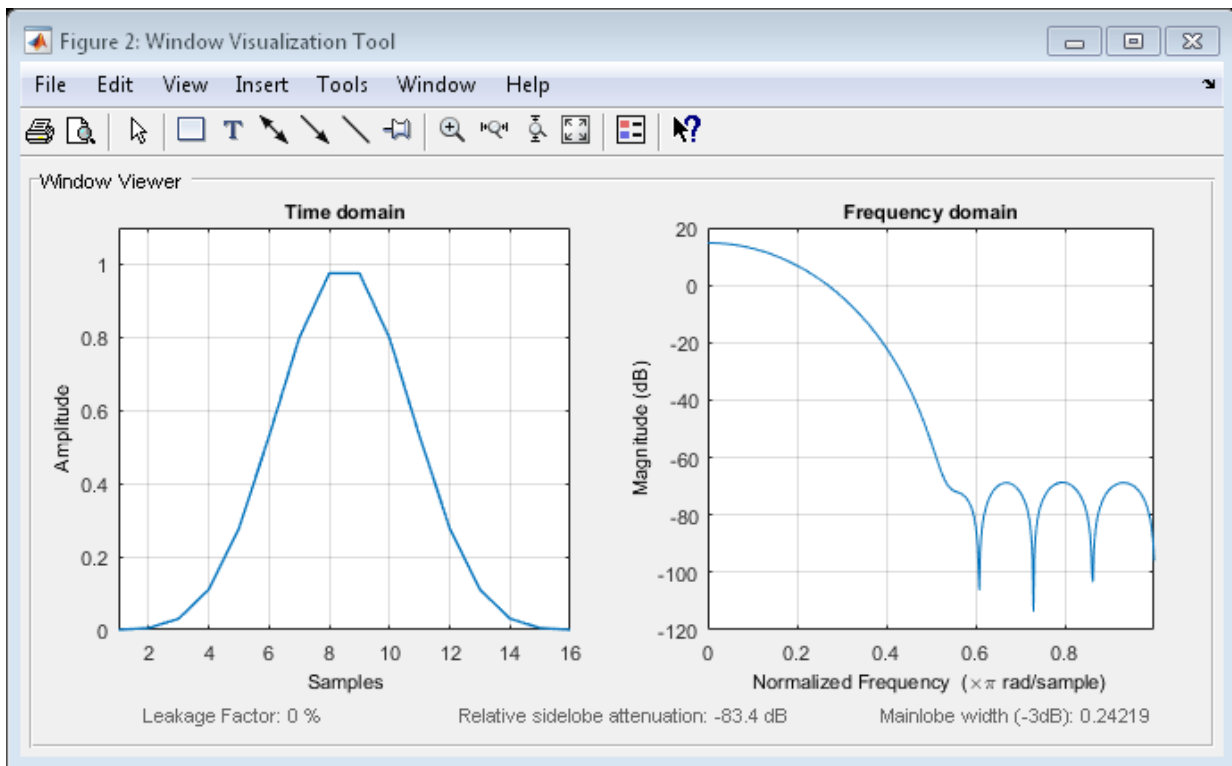

See Also

See Also

[nuttallwin](#) | [window](#) | [wvtool](#)

Topics

“Windows”

[Class Attributes \(MATLAB\)](#)

[Property Attributes \(MATLAB\)](#)

info

Class: sigwin.nuttallwin

Package: sigwin

Display information about Nuttall defined four-term Blackman-Harris window object

Syntax

```
info(H)
info_win = info(H)
```

Description

`info(H)` displays length information about the Nuttall defined four-term Blackman-Harris window object `H`.

`info_win = info(H)` returns length information about the Nuttall defined four-term Blackman-Harris window object `H` in the character array `info_win`.

Examples

Nuttall-Defined Four-Term Blackman-Harris Windows

Generate two Nuttall-defined four-term Blackman-Harris windows:

- The first window has $N = 64$ and is symmetric.
- The second window has $N = 63$ and is periodic.

Display the two windows.

```
Hs = sigwin.nuttallwin(64);
Hp = sigwin.nuttallwin(63);
Hp.SamplingFlag = 'periodic';

wvt = wvtool(Hs, Hp);
```

```
legend(wvt.CurrentAxes, 'Symmetric', 'Periodic')
```

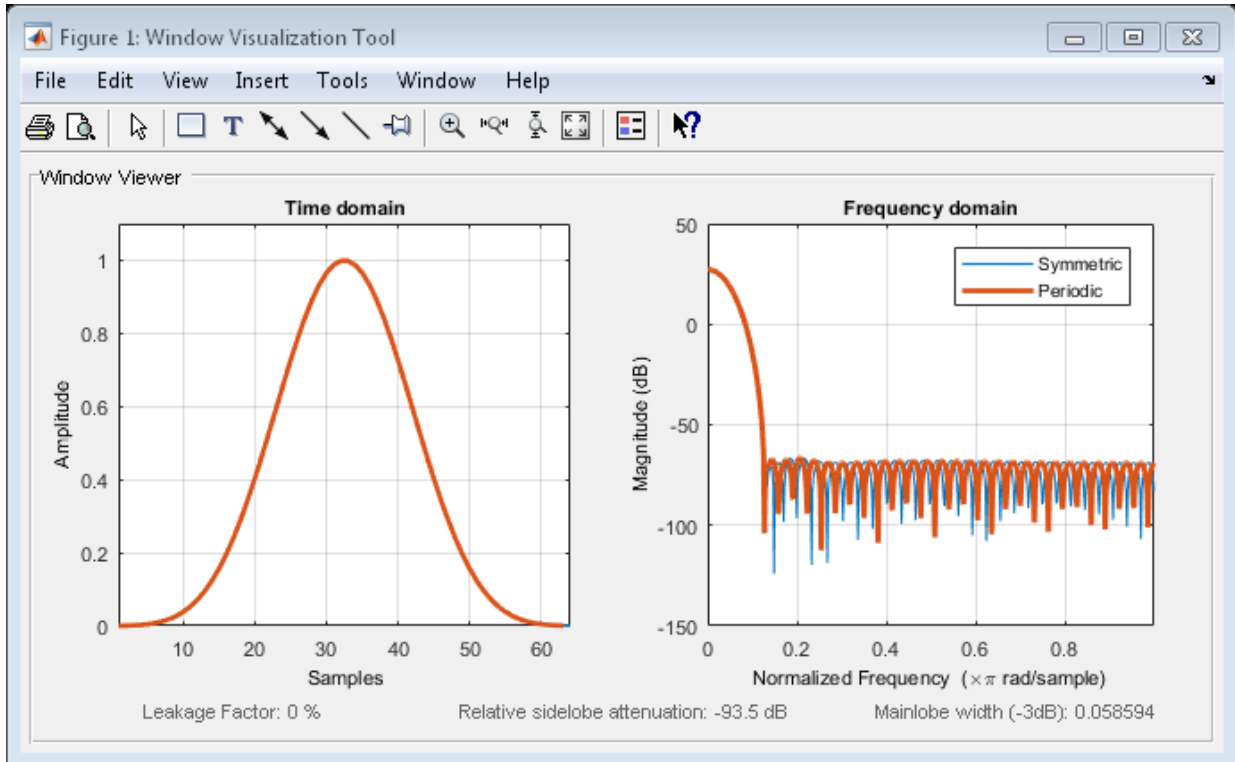

Generate a symmetric Nuttall-defined four-term Blackman-Harris window with $N = 16$. Return the window values as a column vector. Write the coefficients to an ASCII file in the current directory. Show information about the window object. Display the window.

```
H = sigwin.nuttallwin(16);
```

```
win = generate(H)
```

```
win =
```

```
0.0004
0.0048
0.0306
0.1105
0.2778
```

```
0.5292
0.7983
0.9755
0.9755
0.7983
```

```
winwrite(H,'nuttallwin_16');
wininfo = info(H)
```

```
wininfo = 4x26 char array
    'Nuttall Window'
    '-----'
    'Length          : 16'
    'Sampling Flag   : symmetric'
```

```
wvtool(H)
```

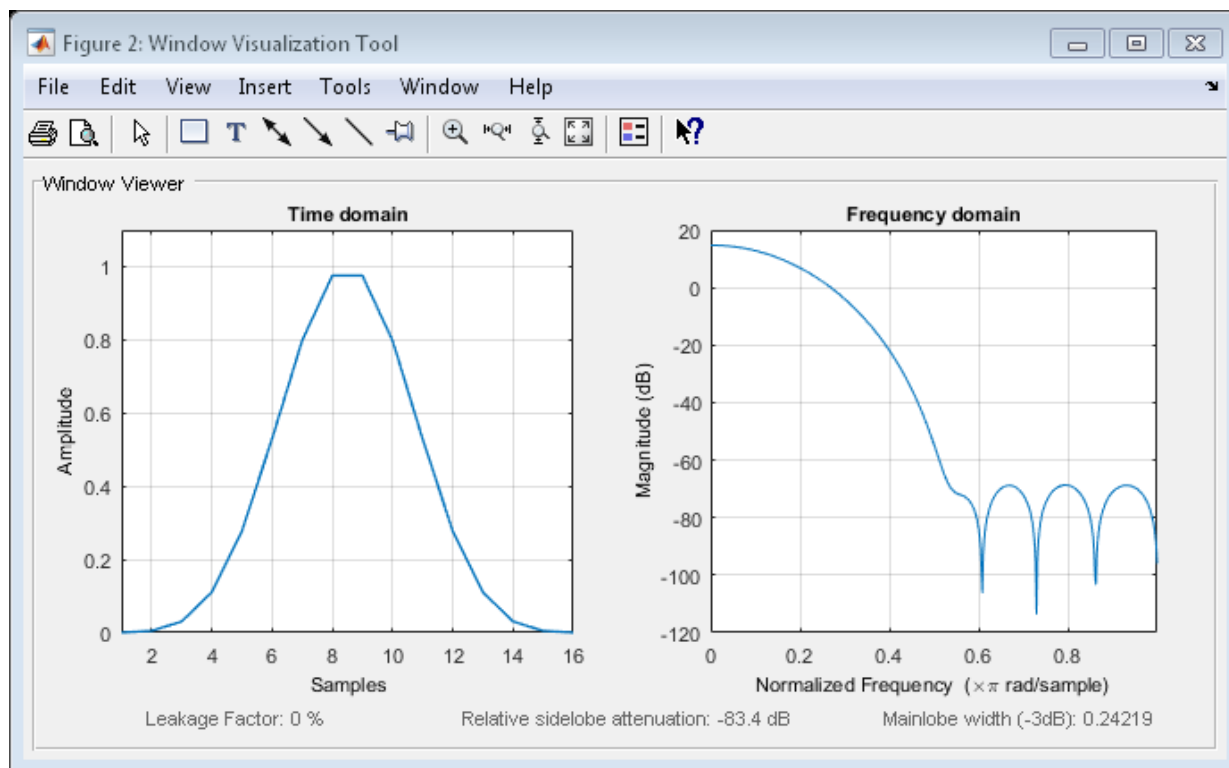

See Also

See Also

`nuttallwin` | `window` | `wvtool`

Topics

“Windows”

Class Attributes (MATLAB)

Property Attributes (MATLAB)

winwrite

Class: sigwin.nuttallwin

Package: sigwin

Save Nuttall defined four-term Blackman-Harris window object values in ASCII file

Syntax

```
winwrite(H)
winwrite(H, 'filename')
```

Description

`winwrite(H)` opens a dialog to export the values of the Nuttall defined four-term Blackman-Harris window object `H` to an ASCII file. The file extension `.wf` is automatically appended.

`winwrite(H, 'filename')` saves the values of the Nuttall defined four-term Blackman-Harris window object `H` in the current folder as a column vector in the ASCII file `'filename'`. The file extension `.wf` is automatically appended to `filename`.

Examples

Nuttall-Defined Four-Term Blackman-Harris Windows

Generate two Nuttall-defined four-term Blackman-Harris windows:

- The first window has $N = 64$ and is symmetric.
- The second window has $N = 63$ and is periodic.

Display the two windows.

```
Hs = sigwin.nuttallwin(64);
Hp = sigwin.nuttallwin(63);
Hp.SamplingFlag = 'periodic';

wvt = wvtool(Hs, Hp);
```



```
legend(wvt.CurrentAxes, 'Symmetric', 'Periodic')
```

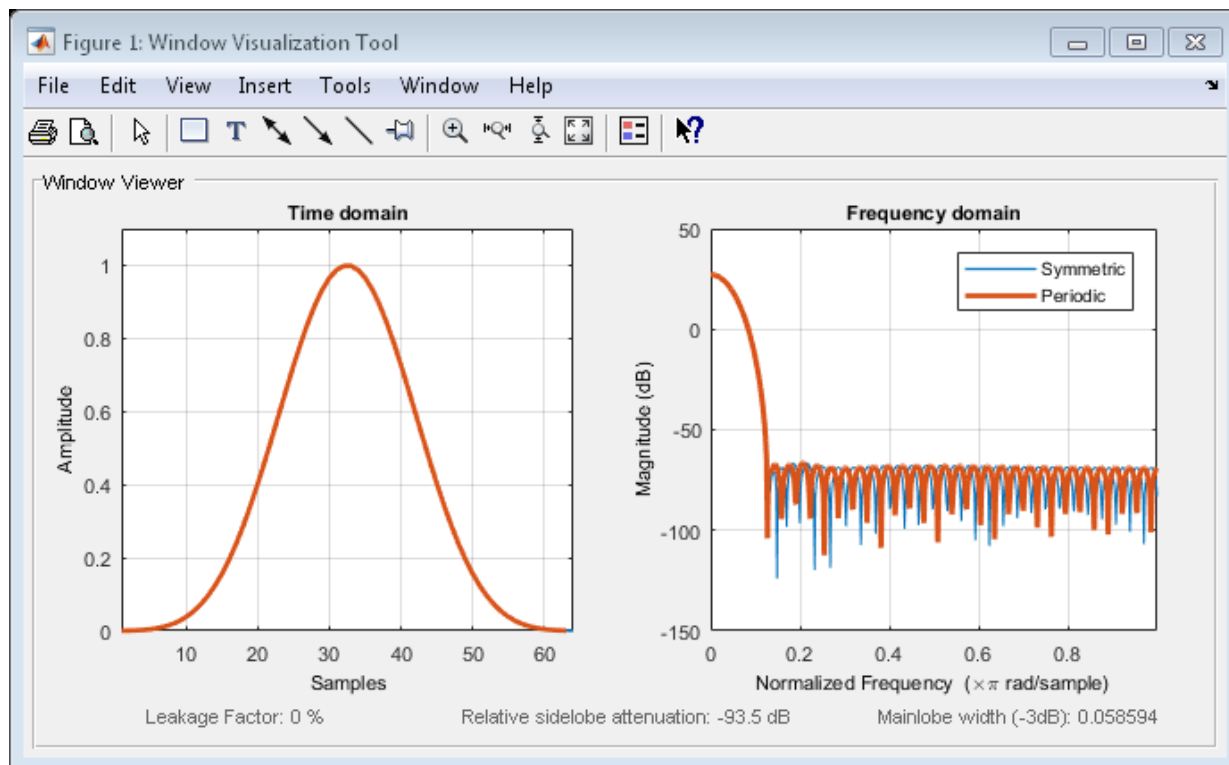

Generate a symmetric Nuttall-defined four-term Blackman-Harris window with $N = 16$. Return the window values as a column vector. Write the coefficients to an ASCII file in the current directory. Show information about the window object. Display the window.

```
H = sigwin.nuttallwin(16);
```

```
win = generate(H)
```

```
win =
```

```
0.0004
0.0048
0.0306
0.1105
0.2778
```

```
0.5292
0.7983
0.9755
0.9755
0.7983
```

```
winwrite(H,'nuttallwin_16');
wininfo = info(H)
```

```
wininfo = 4x26 char array
    'Nuttall Window'
    '-----'
    'Length          : 16'
    'Sampling Flag   : symmetric'
```

```
wvtool(H)
```

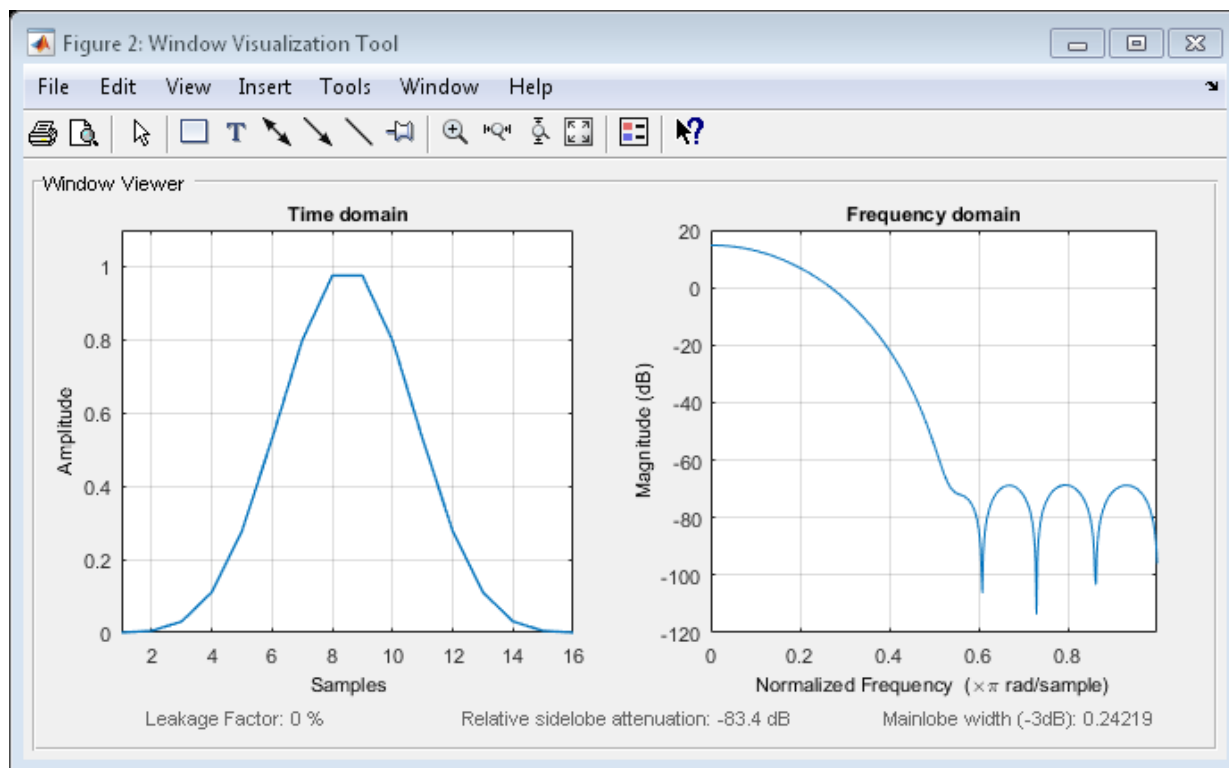

See Also

See Also

`nuttallwin` | `window` | `wvtool`

Topics

“Windows”

Class Attributes (MATLAB)

Property Attributes (MATLAB)

sigwin.parzenwin class

Package: sigwin

Construct Parzen window object

Description

Note: The use of `sigwin.parzenwin` is not recommended. Use `parzenwin` instead.

`sigwin.parzenwin` creates a handle to a Parzen window object for use in spectral analysis and FIR filtering by the window method. Object methods enable workspace import and ASCII file export of the window values.

The following equation defines the N -point Parzen window over the interval

$$-\frac{(N-1)}{2} \leq n \leq \frac{(N-1)}{2} :$$

$$w(n) = \begin{cases} 1 - 6\left(\frac{|n|}{N/2}\right)^2 + 6\left(\frac{|n|}{N/2}\right)^3, & 0 \leq |n| \leq (N-1)/4 \\ 2\left(1 - \frac{|n|}{N/2}\right)^3, & (N-1)/4 < |n| \leq (N-1)/2 \end{cases}$$

Construction

`H = sigwin.parzenwin` returns a Parzen window object `H` of length 64.

`H = sigwin.parzenwin(Length)` returns a Parzen window object `H` of length *Length*. *Length* requires a positive integer. Entering a positive noninteger value for *Length* rounds the length to the nearest integer. Entering a 1 for *Length* results in a window with a single value of 1.

Properties

Length

Length requires a positive integer. Entering a positive noninteger value for *Length* rounds the length to the nearest integer. Entering a 1 for *Length* results in a window with a single value of 1.

Methods

generate	Generate Parzen window
info	Display information about Parzen window object
winwrite	Save Parzen window in ASCII file

Copy Semantics

Handle. To learn how copy semantics affect your use of the class, see Copying Objects (MATLAB) in the MATLAB Programming Fundamentals documentation.

Examples

Parzen Window

Generate a Parzen window of length $N = 16$. Return its values as a column vector. Write the coefficients to an ASCII file in the current directory. Show information about the window object. Display the window.

```
H = sigwin.parzenwin(16);
```

```
win = generate(H)
```

```
win =
```

```
0.0005  
0.0132  
0.0610  
0.1675
```

```
0.3540
0.5972
0.8286
0.9780
0.9780
0.8286
```

```
winwrite(H,'parzenwin_16');
wininfo = info(H)
```

```
wininfo = 3×13 char array
'Parzen Window'
'-----'
'Length : 16 '
```

```
wvtool(H)
```

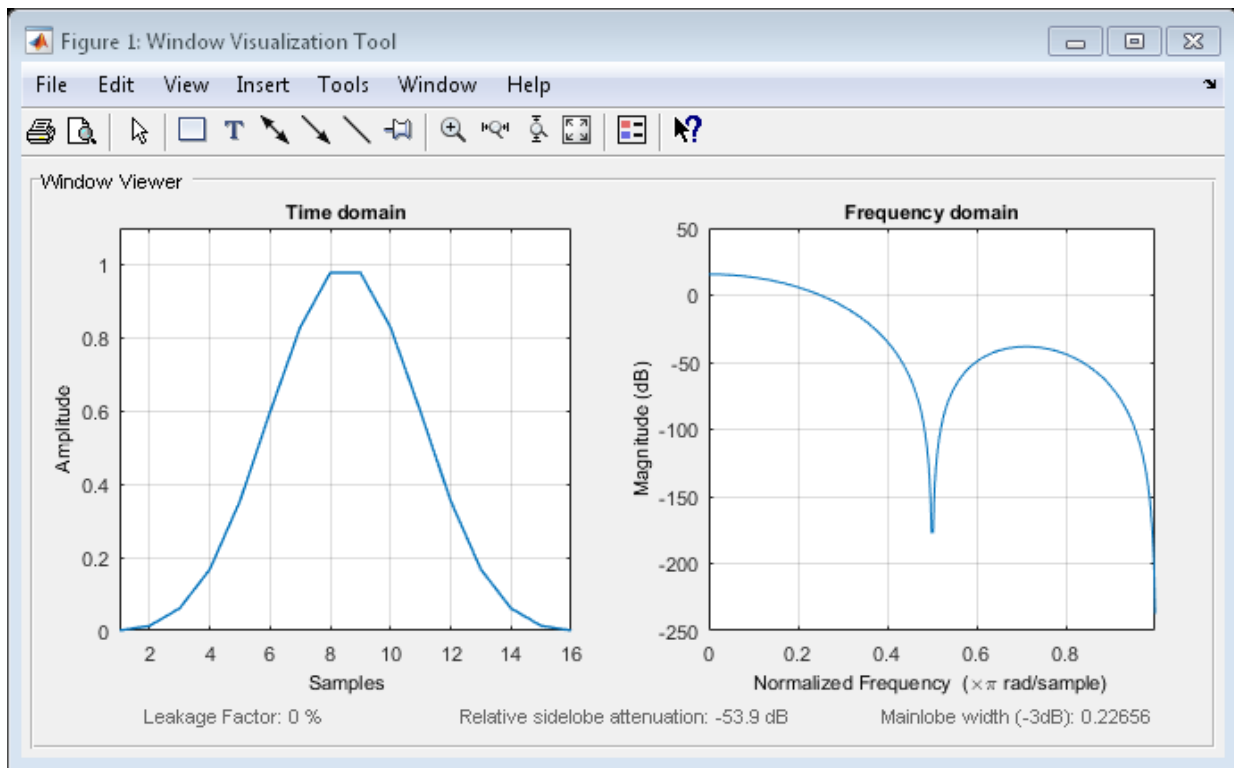

References

harris, fredric j. “On the Use of Windows for Harmonic Analysis with the Discrete Fourier Transform.” *Proceedings of the IEEE*. Vol. 66, January 1978, pp. 51–83.

See Also

See Also

parzenwin | window | wvtool

Topics

“Windows”

Class Attributes (MATLAB)

Property Attributes (MATLAB)

generate

Class: sigwin.parzenwin

Package: sigwin

Generate Parzen window

Syntax

```
win = generate(H)
```

Description

`win = generate(H)` returns the values of the Parzen window object as a double-precision column vector.

Examples

Parzen Window

Generate a Parzen window of length $N = 16$. Return its values as a column vector. Write the coefficients to an ASCII file in the current directory. Show information about the window object. Display the window.

```
H = sigwin.parzenwin(16);
```

```
win = generate(H)
```

```
win =
```

```
    0.0005  
    0.0132  
    0.0610  
    0.1675  
    0.3540  
    0.5972
```



```
0.8286
0.9780
0.9780
0.8286
```

```
winwrite(H, 'parzenwin_16');
wininfo = info(H)
```

```
wininfo = 3×13 char array
    'Parzen Window'
    '-----'
    'Length : 16 '
```

```
wvtool(H)
```

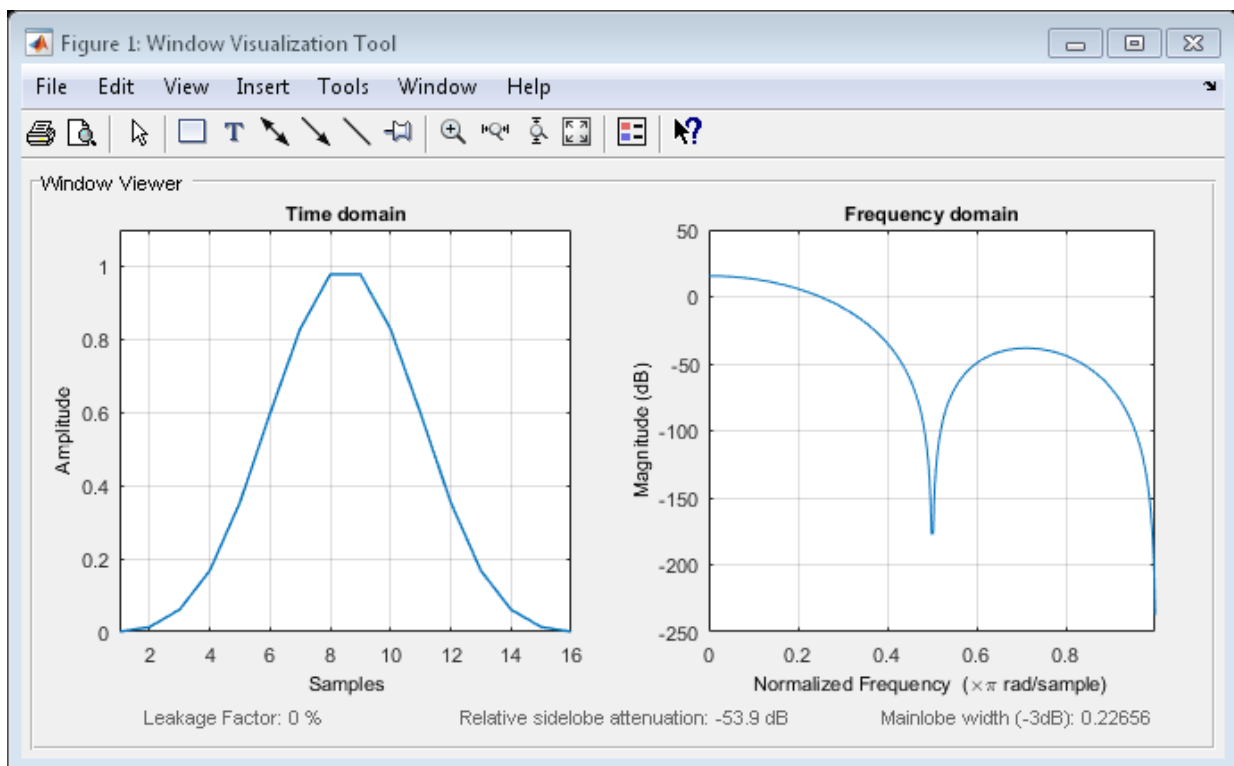

See Also

See Also

parzenwin | window | wvtool

Topics

“Windows”

Class Attributes (MATLAB)

Property Attributes (MATLAB)

info

Class: sigwin.parzenwin

Package: sigwin

Display information about Parzen window object

Syntax

```
info(H)
```

```
info_win=info(H)
```

Description

`info(H)` displays length information about the Parzen window object `H`.

`info_win=info(H)` returns length information about the Parzen window object `H` in the character array `info_win`.

Examples

Parzen Window

Generate a Parzen window of length $N = 16$. Return its values as a column vector. Write the coefficients to an ASCII file in the current directory. Show information about the window object. Display the window.

```
H = sigwin.parzenwin(16);
```

```
win = generate(H)
```

```
win =
```

```
0.0005  
0.0132  
0.0610  
0.1675  
0.3540
```

```
0.5972
0.8286
0.9780
0.9780
0.8286
```

```
winwrite(H, 'parzenwin_16');
wininfo = info(H)
```

```
wininfo = 3×13 char array
    'Parzen Window'
    '-----'
    'Length : 16 '
```

```
wvtool(H)
```

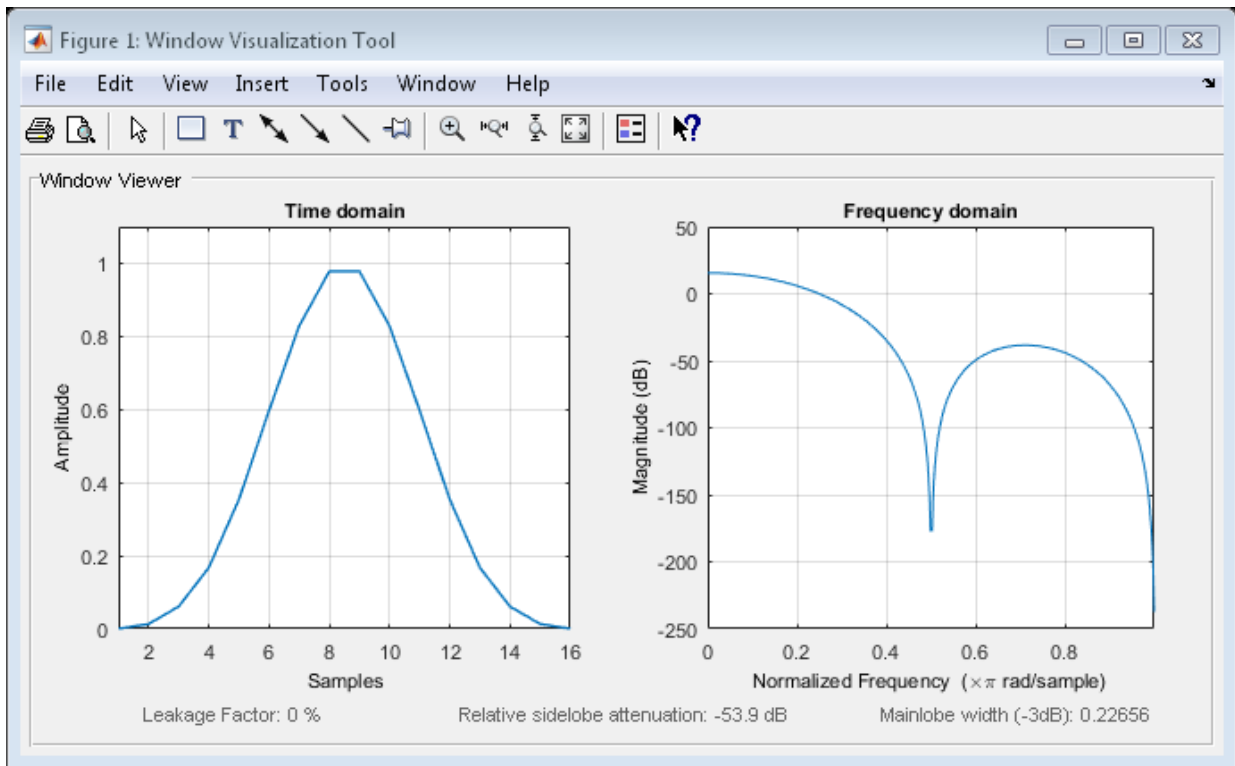

See Also

See Also

parzenwin | window | wvtool

Topics

“Windows”

Class Attributes (MATLAB)

Property Attributes (MATLAB)

winwrite

Class: sigwin.parzenwin

Package: sigwin

Save Parzen window in ASCII file

Syntax

```
winwrite(H)
winwrite(H, 'filename')
```

Description

`winwrite(H)` opens a dialog to export the values of the Parzen window object `H` to an ASCII file. The file extension `.wf` is automatically appended.

`winwrite(H, 'filename')` saves the values of the Parzen window object `H` in the current folder as a column vector in the ASCII file `'filename'`. The file extension `.wf` is automatically appended to `filename`.

Examples

Parzen Window

Generate a Parzen window of length $N = 16$. Return its values as a column vector. Write the coefficients to an ASCII file in the current directory. Show information about the window object. Display the window.

```
H = sigwin.parzenwin(16);
```

```
win = generate(H)
```

```
win =
```

```
0.0005
0.0132
0.0610
0.1675
```

```

0.3540
0.5972
0.8286
0.9780
0.9780
0.8286

```

```

winwrite(H,'parzenwin_16');
wininfo = info(H)

```

```

wininfo = 3×13 char array
    'Parzen Window'
    '-----'
    'Length : 16 '

```

```

wvtool(H)

```

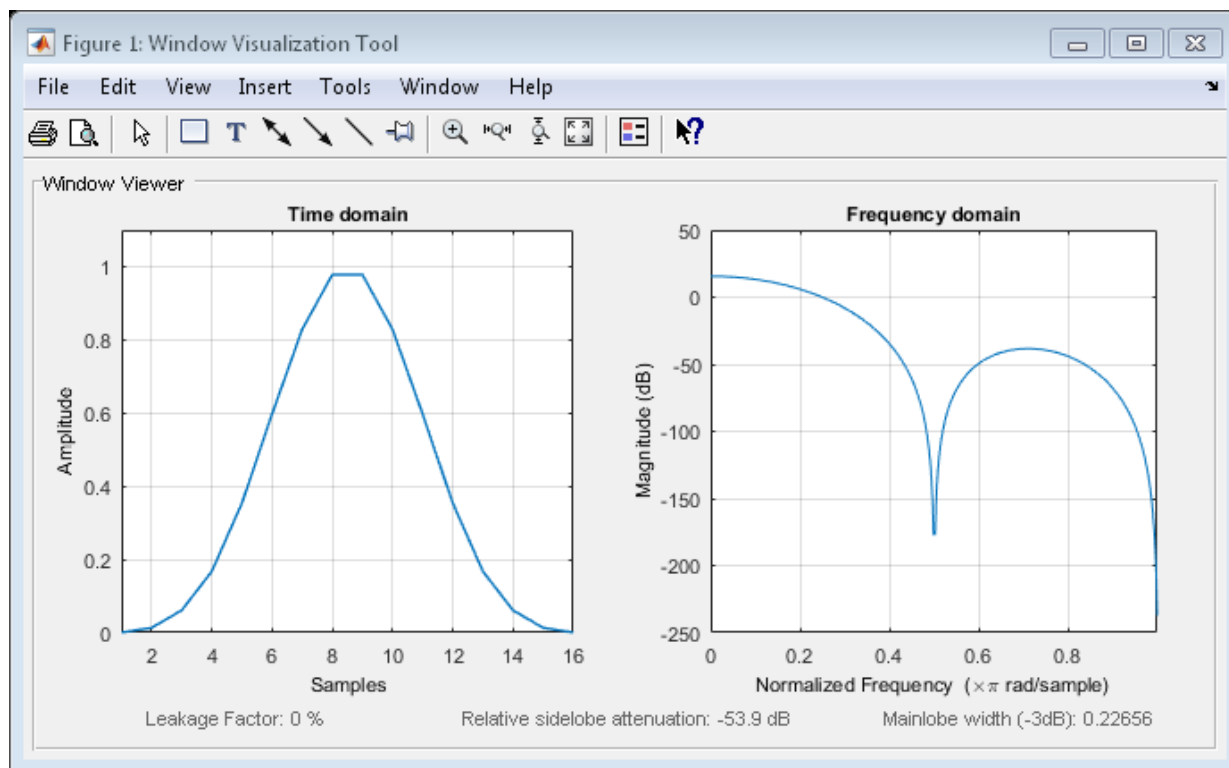

See Also

See Also

parzenwin | window | wvtool

Topics

“Windows”

Class Attributes (MATLAB)

Property Attributes (MATLAB)

sigwin.rectwin class

Package: sigwin

Construct rectangular window object

Description

Note: The use of `sigwin.rectwin` is not recommended. Use `rectwin` instead.

`sigwin.rectwin` creates a handle to a rectangular window object for use in spectral analysis and FIR filtering by the window method. Object methods enable workspace import and ASCII file export of the window values.

The following equation defines the rectangular window of length N :

$$w(n) = 1, \quad 0 \leq n \leq N - 1$$

Construction

`H = sigwin.rectwin` returns a rectangular window object `H` of length 64.

`H = sigwin.rectwin(Length)` returns a rectangular window object `H` of length *Length*. *Length* requires a positive integer. Entering a positive noninteger value for *Length* rounds the length to the nearest integer. Entering a 1 for *Length* results in a window with a single value of 1.

Properties

Length

Rectangular window length. The window length requires a positive integer. Entering a positive noninteger value for *Length* rounds the length to the nearest integer. Entering a 1 for *Length* results in a window with a single value of 1.

Methods

<code>generate</code>	Generates rectangular window
<code>info</code>	Display information about rectangular window object
<code>winwrite</code>	Save rectangular window in ASCII file

Copy Semantics

Handle. To learn how copy semantics affect your use of the class, see Copying Objects (MATLAB) in the MATLAB Programming Fundamentals documentation.

Examples

Rectangular Window

Generate a rectangular window of length $N = 16$. Return its values as a column vector. Write the coefficients to an ASCII file in the current directory. Show information about the window object. Display the window.

```
H = sigwin.rectwin(16);  
  
win = generate(H)  
  
win =  
  
    1  
    1  
    1  
    1  
    1  
    1  
    1  
    1  
    1  
    1  
    1  
    1  
  
winwrite(H, 'rectwin_16');
```

```

wininfo = info(H)

wininfo = 3×18 char array
    'Rectangular Window'
    '-----'
    'Length : 16'

wvtool(H)

```

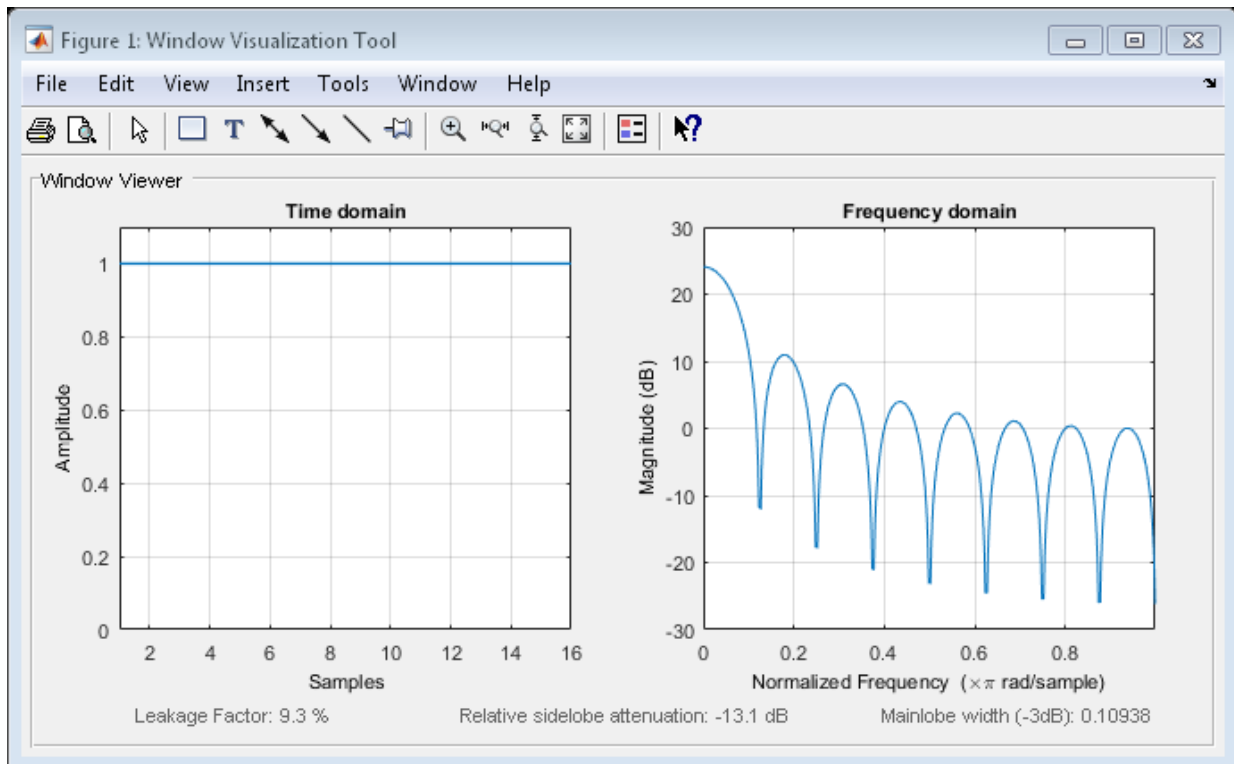

References

Oppenheim, Alan V., and Ronald W. Schaffer. *Discrete-Time Signal Processing*. Upper Saddle River, NJ: Prentice Hall, 1989.

See Also

See Also

[rectwin](#) | [window](#) | [wvtool](#)

Topics

“Windows”

[Class Attributes \(MATLAB\)](#)

[Property Attributes \(MATLAB\)](#)

generate

Class: sigwin.rectwin

Package: sigwin

Generates rectangular window

Syntax

```
win = generate(H)
```

Description

`win = generate(H)` returns the values of the rectangular window object `H` as a double-precision column vector.

Examples

Rectangular Window

Generate a rectangular window of length $N = 16$. Return its values as a column vector. Write the coefficients to an ASCII file in the current directory. Show information about the window object. Display the window.

```
H = sigwin.rectwin(16);
```

```
win = generate(H)
```

```
win =
```

```
    1  
    1  
    1  
    1  
    1  
    1  
    1
```

```

1
1
1
1

winwrite(H,'rectwin_16');
wininfo = info(H)

wininfo = 3×18 char array
    'Rectangular Window'
    '-----'
    'Length : 16      '

wvtool(H)

```

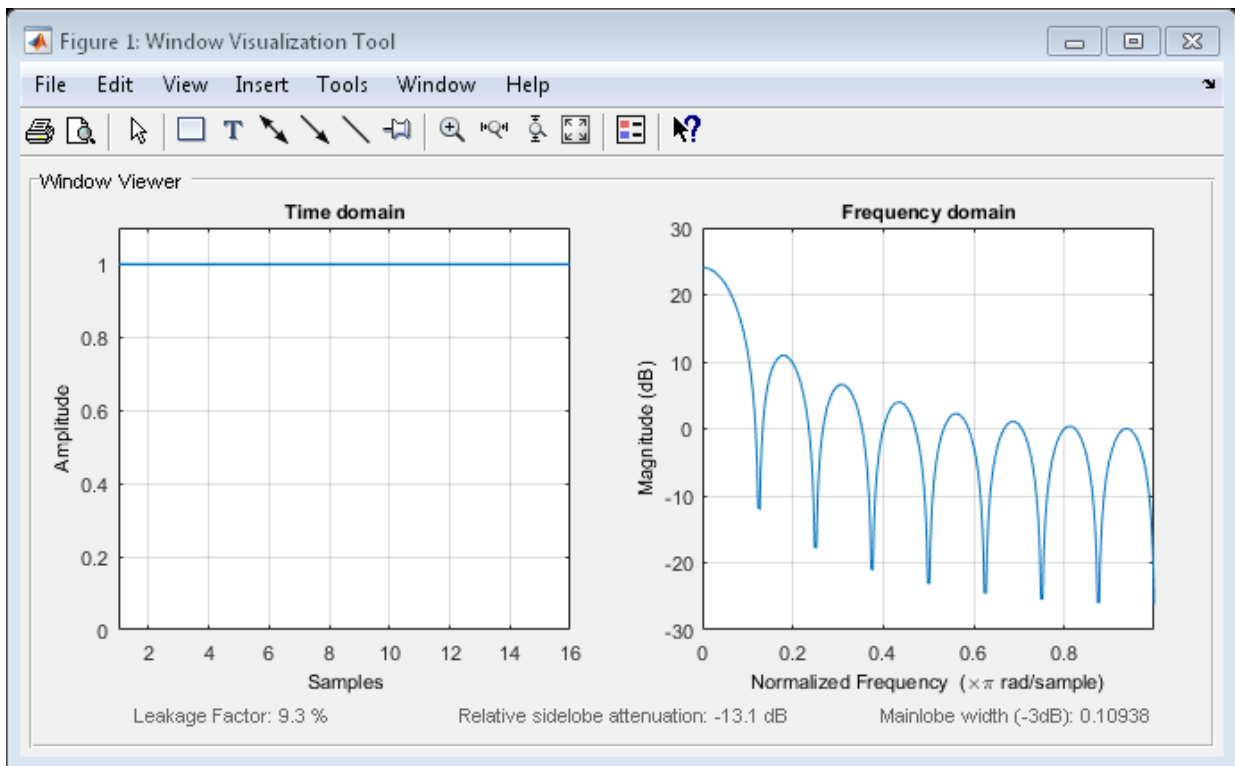

See Also

See Also

[rectwin](#) | [window](#) | [wvtool](#)

Topics

“Windows”

[Class Attributes \(MATLAB\)](#)

[Property Attributes \(MATLAB\)](#)

info

Class: sigwin.rectwin

Package: sigwin

Display information about rectangular window object

Syntax

```
info(H)
info_win = info(H)
```

Description

`info(H)` displays length information for the rectangular window object `H`.

`info_win = info(H)` returns length information for the rectangular window object `H` in the character array `info_win`.

Examples

Rectangular Window

Generate a rectangular window of length $N = 16$. Return its values as a column vector. Write the coefficients to an ASCII file in the current directory. Show information about the window object. Display the window.

```
H = sigwin.rectwin(16);
```

```
win = generate(H)
```

```
win =
```

```
1
1
1
1
1
1
```



```

1
1
1
1
1
1

winwrite(H,'rectwin_16');
wininfo = info(H)

wininfo = 3×18 char array
    'Rectangular Window'
    '-----'
    'Length : 16'

wvtool(H)

```

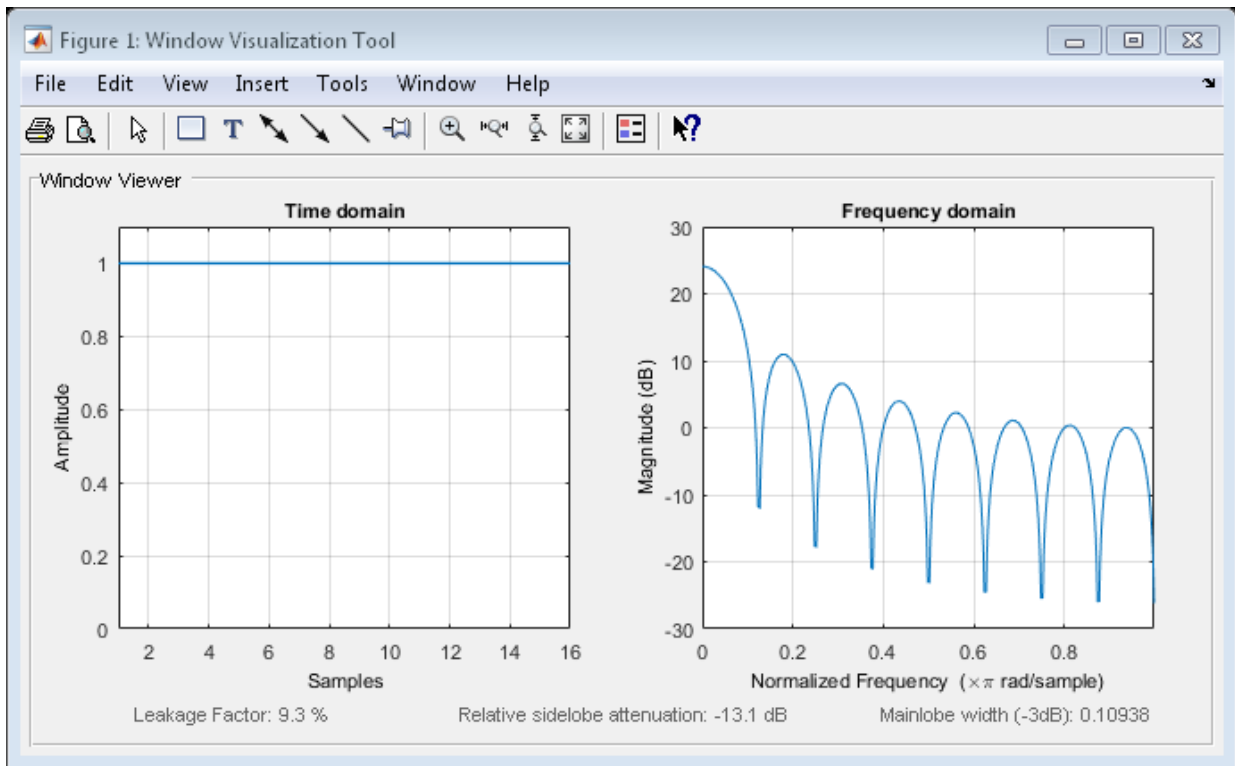

See Also

See Also

`rectwin` | `window` | `wvtool`

Topics

“Windows”

Class Attributes (MATLAB)

Property Attributes (MATLAB)

winwrite

Class: sigwin.rectwin

Package: sigwin

Save rectangular window in ASCII file

Syntax

```
winwrite(H)
winwrite(H, 'filename')
```

Description

`winwrite(H)` opens a dialog to export the values of the rectangular window object `H` to an ASCII file. The file extension `.wf` is automatically appended.

`winwrite(H, 'filename')` saves the values of the rectangular window object `H` in the current folder as a column vector in the ASCII file `'filename'`. The file extension `.wf` is automatically appended to `filename`.

Examples

Rectangular Window

Generate a rectangular window of length $N = 16$. Return its values as a column vector. Write the coefficients to an ASCII file in the current directory. Show information about the window object. Display the window.

```
H = sigwin.rectwin(16);
```

```
win = generate(H)
```

```
win =
```

```
1
1
1
1
```

```

1
1
1
1
1
1
1

winwrite(H,'rectwin_16');
wininfo = info(H)

wininfo = 3×18 char array
'Rectangular Window'
'-----'
'Length : 16'

wvtool(H)

```

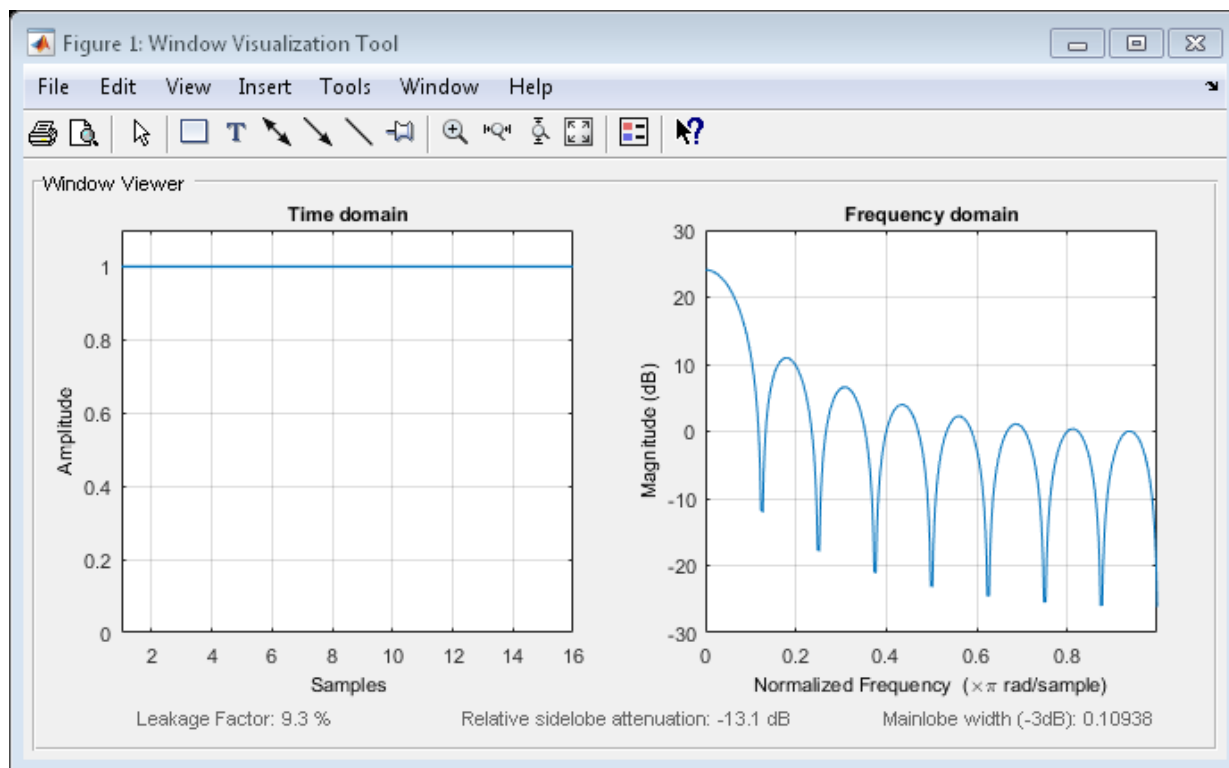

See Also

See Also

`rectwin` | `window` | `wvtool`

Topics

“Windows”

Class Attributes (MATLAB)

Property Attributes (MATLAB)

sigwin.taylorwin class

Package: sigwin

Construct Taylor window object

Description

Note: The use of `sigwin.taylorwin` is not recommended. Use `taylorwin` instead.

`sigwin.taylorwin` creates a handle to a Taylor window object for use in spectral analysis and FIR filtering by the `window` method. Object methods enable workspace import and ASCII file export of the window values.

Taylor windows are similar to Dolph-Chebyshev windows. The Taylor window approximates the minimization of the main lobe width in the Dolph-Chebyshev window, but allows the sidelobe levels to decrease beyond a certain frequency. Taylor windows are typically used in radar applications, such as weighting synthetic aperture radar images and antenna design.

Construction

`H = sigwin.taylorwin` returns a Taylor window object `H` of length 64, with a maximum sidelobe level of 30 dB and 4 constant-level sidelobes adjacent to the main lobe.

`H = sigwin.taylorwin(Length)` returns a Taylor window object `H` of length *Length* with a maximum sidelobe level of 30 dB and 4 constant-level sidelobes adjacent to the main lobe. *Length* must be a positive integer. Entering a positive noninteger value for *Length* rounds the length to the nearest integer. Entering a 1 for *Length* results in a window with a single value of 1.

`H = sigwin.taylorwin(Length,Nbar)` returns a Taylor window object with *Nbar* nearly constant-level sidelobes adjacent to the main lobe. *Nbar* must be a positive integer.

`H = sigwin.taylorwin(Length,Nbar,SideLobeLevel)` returns a Taylor window object with a maximum sidelobe level *SideLobeLevel* dB below the main lobe level.

Properties

Length

Taylor window length. The window length must be a positive integer. Entering a positive noninteger value for *Length* rounds the length to the nearest integer. Entering a 1 for *Length* results in a window with a single value of 1.

Nbar

Number of nearly constant-level sidelobes. Must be a positive integer.

SideLobeLevel

Maximum sidelobe level relative to the main lobe peak. The maximum sidelobe level is a nonnegative number which gives side lobes *SideLobeLevel* dB down from the main lobe peak.

Methods

<code>generate</code>	Generates Taylor window
<code>info</code>	Display information about Taylor window object
<code>winwrite</code>	Save Taylor window object values in ASCII file

Copy Semantics

Handle. To learn how copy semantics affect your use of the class, see Copying Objects (MATLAB) in the MATLAB Programming Fundamentals documentation.

Examples

Taylor Windows

Generate a Taylor window of length $N = 32$ with a maximum sidelobe level of 60 dB and two constant-level sidelobes adjacent to the mainlobe. Display the window.

```
H = sigwin.taylorwin(32,3,60);

wvt = wvtool(H);
ax = wvt.CurrentAxes;
ax.YLim = [-50 50];
```

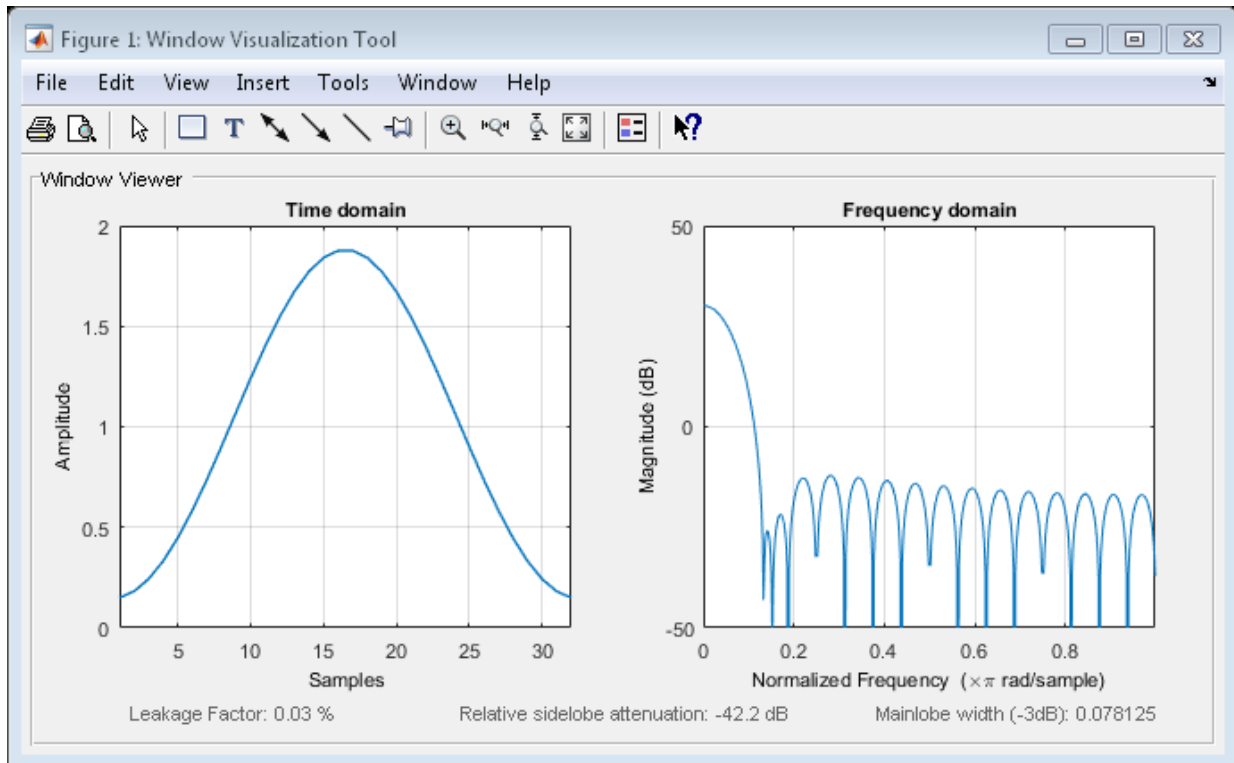

Generate a Taylor window of length $N = 16$. Return its values as a column vector. Write the coefficients to an ASCII file in the current directory. Show information about the window object. Display the window.

```
H = sigwin.taylorwin(16);
win = generate(H)
win =
    0.3931
    0.5021
    0.6912
    0.9174
    1.1409
    1.3330
    1.4737
    1.5485
    1.5485
    1.4737

winwrite(H,'taylorwin_16');
wininfo = info(H)

wininfo = 5x47 char array
    'Taylor Window'
    '-----'
    'Length' : 16'
    'Number of nearly constant-level sidelobes' : 4 '
    'Maximum sidelobe level' : 30'
```

```
wvtool(H)
```

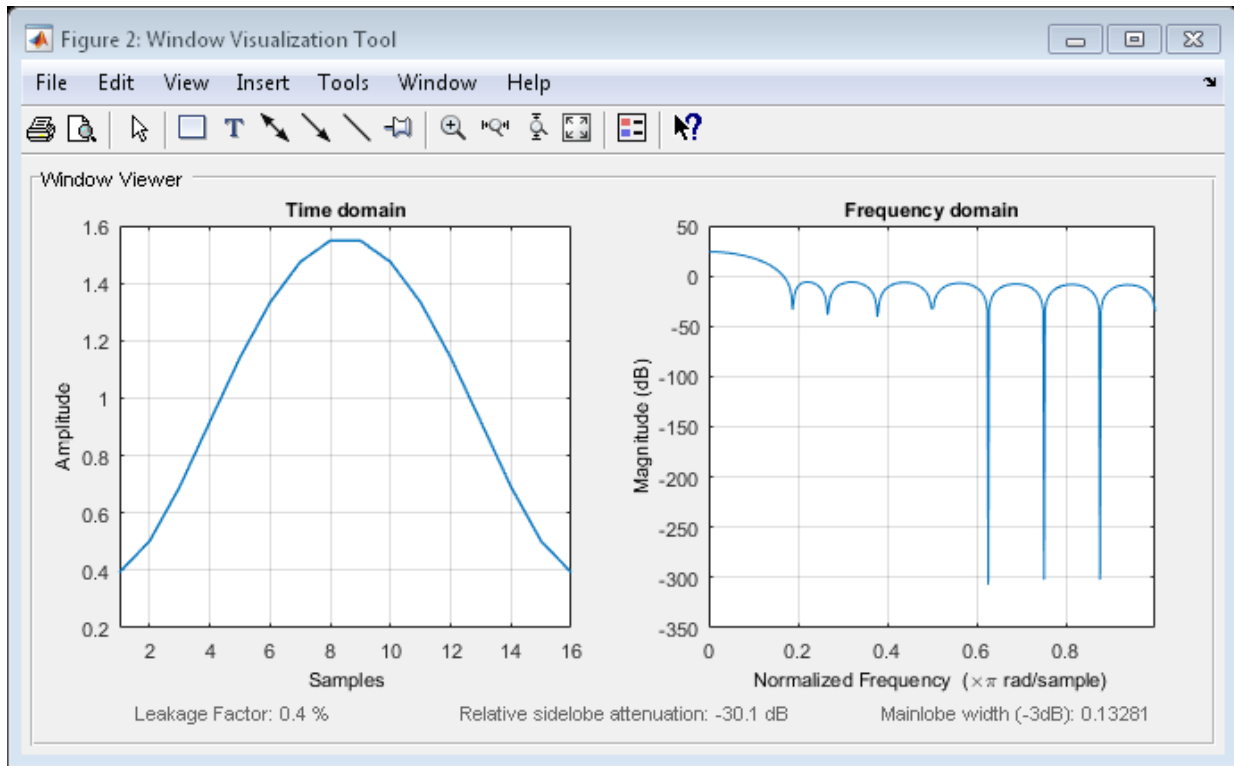

References

Carrara, W. G., R. M. Majewski, and R. S. Goodman. *Spotlight Synthetic Aperture Radar: Signal Processing Algorithms*. Boston: Artech House Publishers, 1995. Appendix D.2.

See Also

See Also

taylorwin | window | wvtool

Topics

“Windows”

Class Attributes (MATLAB)

Property Attributes (MATLAB)

generate

Class: sigwin.taylorwin

Package: sigwin

Generates Taylor window

Syntax

```
win = generate(H)
```

Description

`win = generate(H)` returns the values of the Taylor window object `H` as a double-precision column vector.

Examples

Taylor Windows

Generate a Taylor window of length $N = 32$ with a maximum sidelobe level of 60 dB and two constant-level sidelobes adjacent to the mainlobe. Display the window.

```
H = sigwin.taylorwin(32,3,60);
```

```
wvt = wvtool(H);  
ax = wvt.CurrentAxes;  
ax.YLim = [-50 50];
```

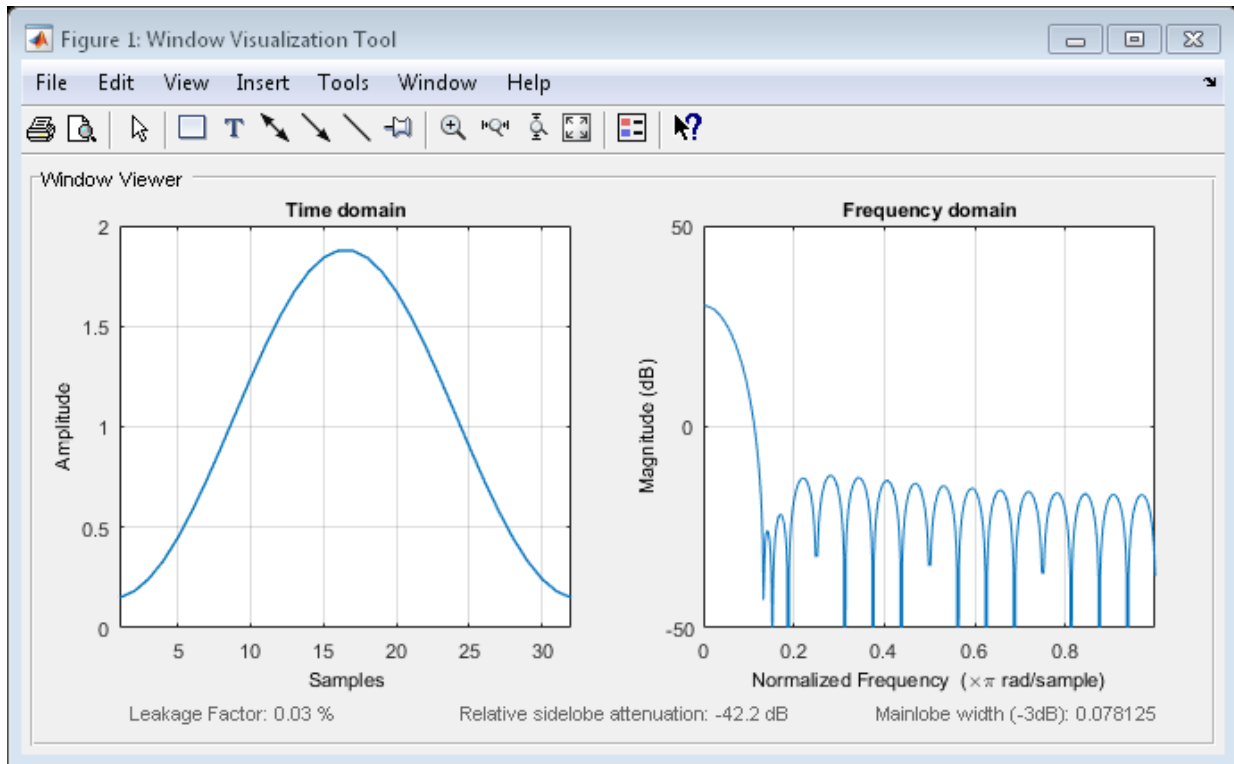

Generate a Taylor window of length $N = 16$. Return its values as a column vector. Write the coefficients to an ASCII file in the current directory. Show information about the window object. Display the window.

```
H = sigwin.taylorwin(16);
```

```
win = generate(H)
```

```
win =
```

```
0.3931
0.5021
0.6912
0.9174
1.1409
1.3330
1.4737
```

```
1.5485
1.5485
1.4737
```

```
winwrite(H, 'taylorwin_16');
wininfo = info(H)
```

```
wininfo = 5x47 char array
    'Taylor Window'
    '-----'
    'Length' : 16'
    'Number of nearly constant-level sidelobes' : 4 '
    'Maximum sidelobe level' : 30'
```

```
wvtool(H)
```

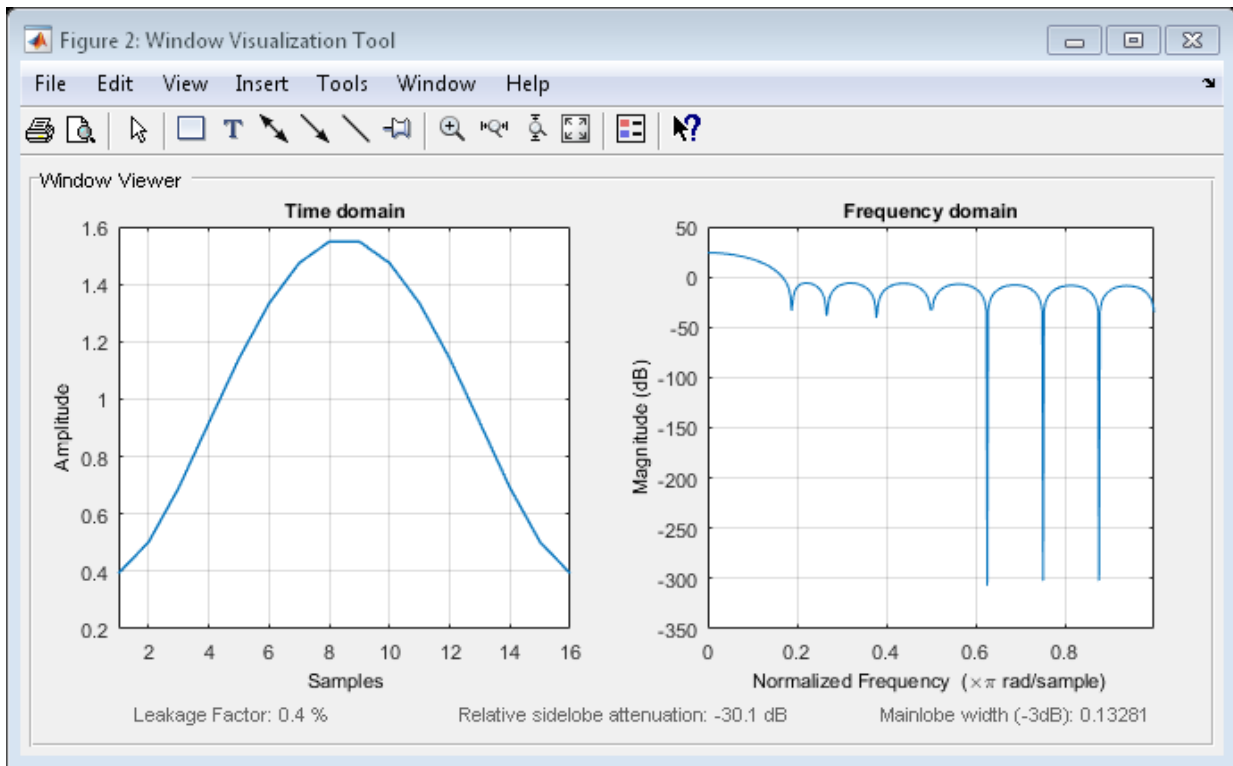

See Also

See Also

taylorwin | window | wvtool

Topics

“Windows”

Class Attributes (MATLAB)

Property Attributes (MATLAB)

info

Class: sigwin.taylorwin

Package: sigwin

Display information about Taylor window object

Syntax

```
info(H)  
info_win = info(H)
```

Description

`info(H)` displays length and sidelobe information for the Taylor window object `H`.

`info_win = info(H)` returns length and sidelobe information for the Taylor window object `H` in the character array `info_win`.

Examples

Taylor Windows

Generate a Taylor window of length $N = 32$ with a maximum sidelobe level of 60 dB and two constant-level sidelobes adjacent to the mainlobe. Display the window.

```
H = sigwin.taylorwin(32,3,60);  
  
wvt = wvtool(H);  
ax = wvt.CurrentAxes;  
ax.YLim = [-50 50];
```

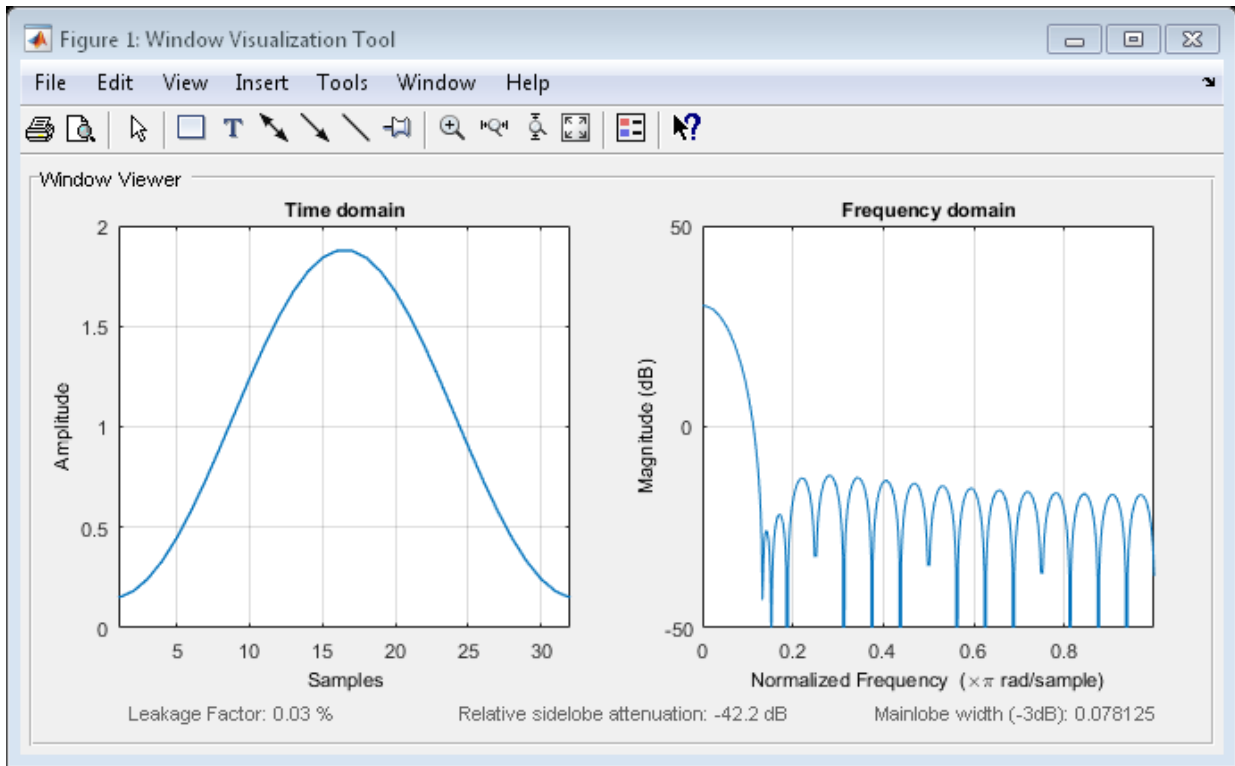
Generate a Taylor window of length $N = 16$. Return its values as a column vector. Write the coefficients to an ASCII file in the current directory. Show information about the window object. Display the window.

```
H = sigwin.taylorwin(16);
```

```
win = generate(H)
```

```
win =
```

```
0.3931
0.5021
0.6912
0.9174
1.1409
1.3330
1.4737
```

```
1.5485
1.5485
1.4737
```

```
winwrite(H, 'taylorwin_16');
wininfo = info(H)
```

```
wininfo = 5x47 char array
    'Taylor Window'
    '-----'
    'Length' : 16'
    'Number of nearly constant-level sidelobes' : 4'
    'Maximum sidelobe level' : 30'
```

```
wvtool(H)
```

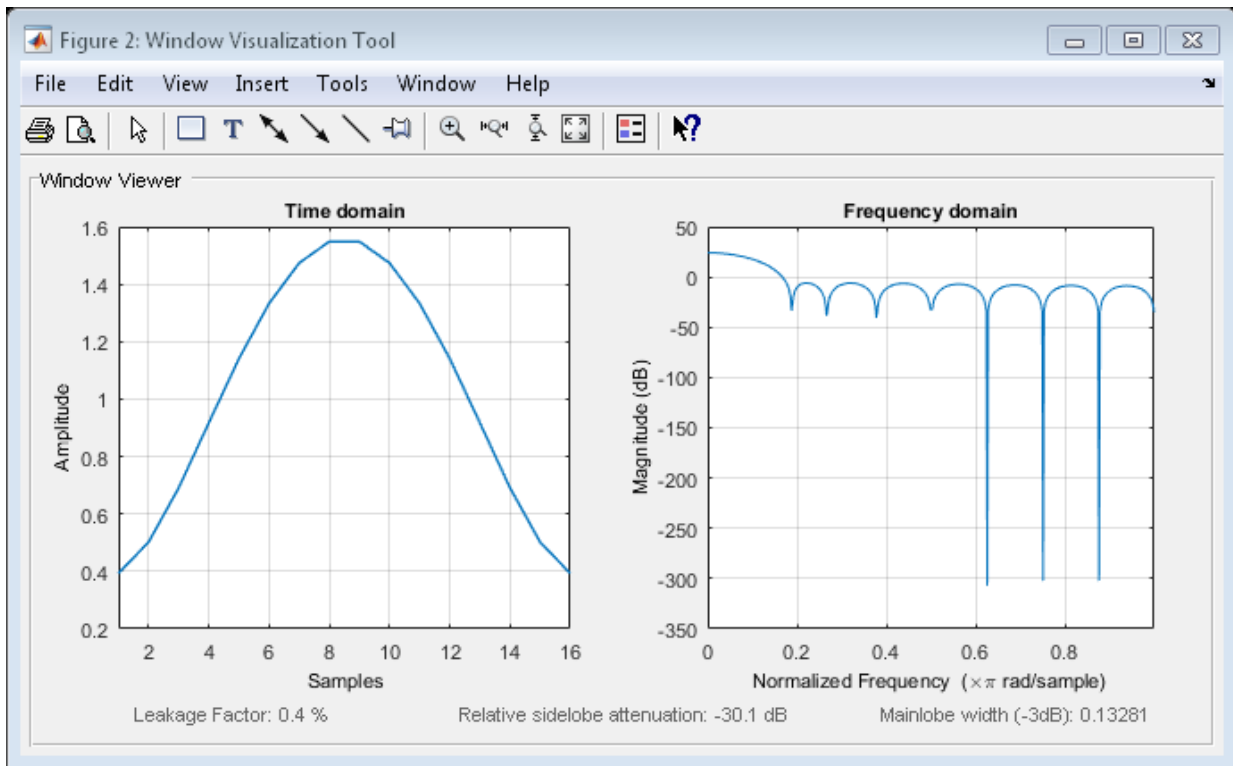

See Also

See Also

taylorwin | window | wvtool

Topics

“Windows”

Class Attributes (MATLAB)

Property Attributes (MATLAB)

winwrite

Class: sigwin.taylorwin

Package: sigwin

Save Taylor window object values in ASCII file

Syntax

```
winwrite(H)
winwrite(H, 'filename')
```

Description

`winwrite(H)` opens a dialog to export the values of the Taylor window object `H` to an ASCII file. The file extension `.wf` is automatically appended.

`winwrite(H, 'filename')` saves the values of the Taylor window object `H` in the current folder as a column vector in the ASCII file `'filename'`. The file extension `.wf` is automatically appended to `filename`.

Examples

Taylor Windows

Generate a Taylor window of length $N = 32$ with a maximum sidelobe level of 60 dB and two constant-level sidelobes adjacent to the mainlobe. Display the window.

```
H = sigwin.taylorwin(32,3,60);
```

```
wvt = wvtool(H);
ax = wvt.CurrentAxes;
ax.YLim = [-50 50];
```

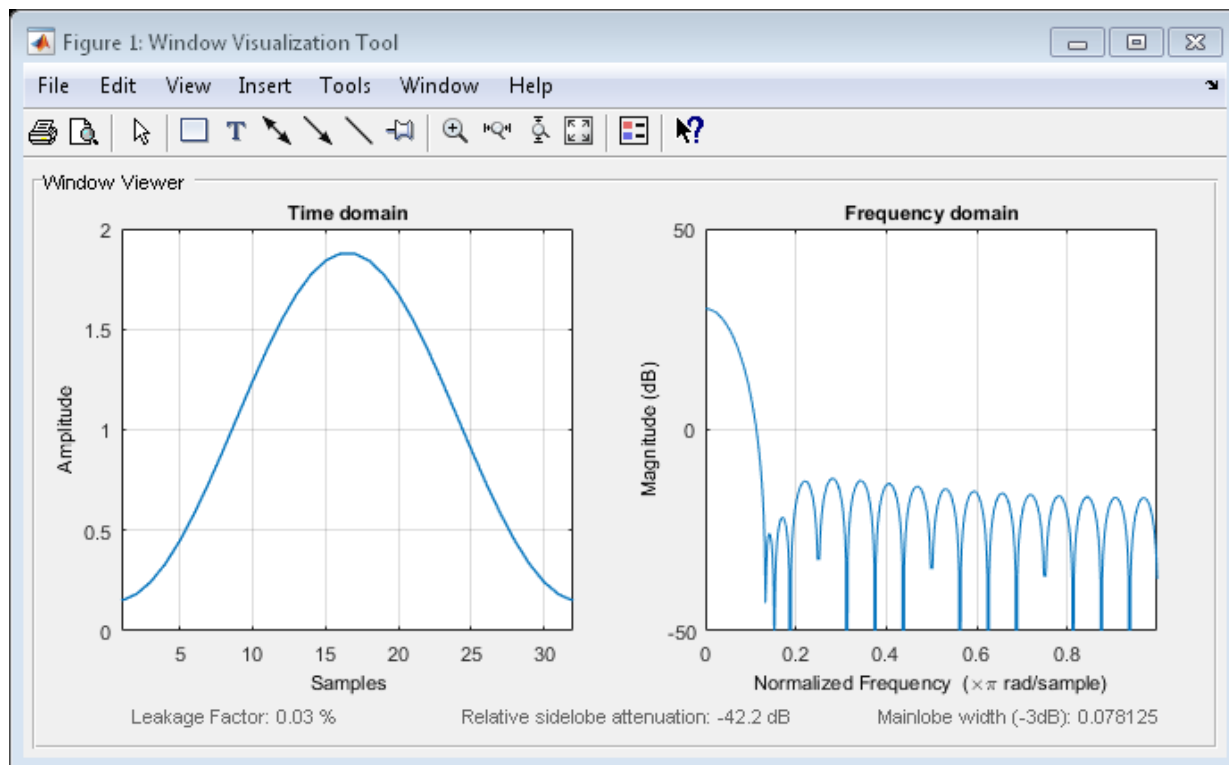

Generate a Taylor window of length $N = 16$. Return its values as a column vector. Write the coefficients to an ASCII file in the current directory. Show information about the window object. Display the window.

```
H = sigwin.taylorwin(16);
```

```
win = generate(H)
```

```
win =
```

```
0.3931
0.5021
0.6912
0.9174
1.1409
1.3330
1.4737
```

```
1.5485
1.5485
1.4737
```

```
winwrite(H, 'taylorwin_16');
wininfo = info(H)
```

```
wininfo = 5x47 char array
    'Taylor Window'
    '-----'
    'Length' : 16'
    'Number of nearly constant-level sidelobes' : 4 '
    'Maximum sidelobe level' : 30'
```

```
wvtool(H)
```

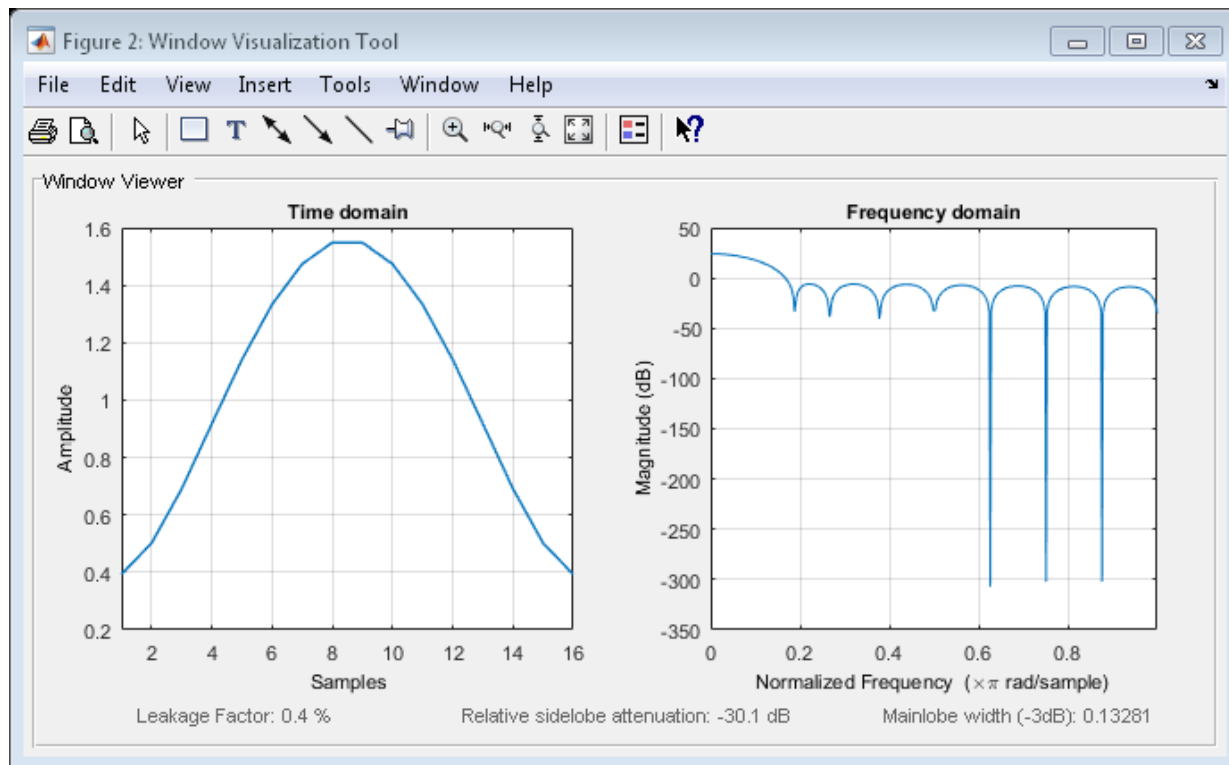

See Also

See Also

taylorwin | window | wvtool

Topics

“Windows”

Class Attributes (MATLAB)

Property Attributes (MATLAB)

sigwin.triang class

Package: sigwin

Construct triangular window object

Description

Note: The use of `sigwin.triang` is not recommended. Use `triang` instead.

`sigwin.triang` is a triangular window object.

`sigwin.triang` creates a handle to a triangular window object for use in spectral analysis and FIR filtering by the `window` method. Object methods enable workspace import and ASCII file export of the window values.

For L odd, the triangular window is defined as:

$$w(n) = \begin{cases} \frac{2n}{L+1} & 1 \leq n \leq (L+1)/2 \\ 2 - \frac{2n}{L+1} & (L+1)/2 + 1 \leq n \leq L \end{cases}$$

For L even, the triangular window is defined as:

$$w(n) = \begin{cases} \frac{(2n-1)}{L} & 1 \leq n \leq L/2 \\ 2 - \frac{(2n-1)}{L} & L/2 + 1 \leq n \leq L \end{cases}$$

Construction

`H = sigwin.triang` returns a triangular window object `H` of length 64.

`H = sigwin.triang(Length)` returns a triangular window object `H` of length *Length*. Entering a positive non-integer value for *Length* rounds the length to the nearest integer. Entering a 1 for *Length* results in a window with a single value of 1.

Properties

Length

Triangular window length. The window length requires a positive integer. Entering a positive non-integer value for *Length* rounds the length to the nearest integer. Entering a 1 for *Length* results in a window with a single value of 1.

Methods

<code>generate</code>	Generates triangular window
<code>info</code>	Display information about triangular window
<code>winwrite</code>	Save triangular window in ASCII file

Copy Semantics

Handle. To learn how copy semantics affect your use of the class, see Copying Objects (MATLAB) in the MATLAB Programming Fundamentals documentation.

Examples

Triangular Window

Generate a triangular window of length $N = 16$. Return its values as a column vector. Write the coefficients to an ASCII file in the current directory. Show information about the window object. Display the window.

```
H = sigwin.triang(16);
```

```
win = generate(H)

win =
    0.0625
    0.1875
    0.3125
    0.4375
    0.5625
    0.6875
    0.8125
    0.9375
    0.9375
    0.8125

winwrite(H, 'triang_16');
wininfo = info(H)

wininfo = 3×17 char array
    'Triangular Window'
    '-----'
    'Length : 16      '

wvtool(H)
```

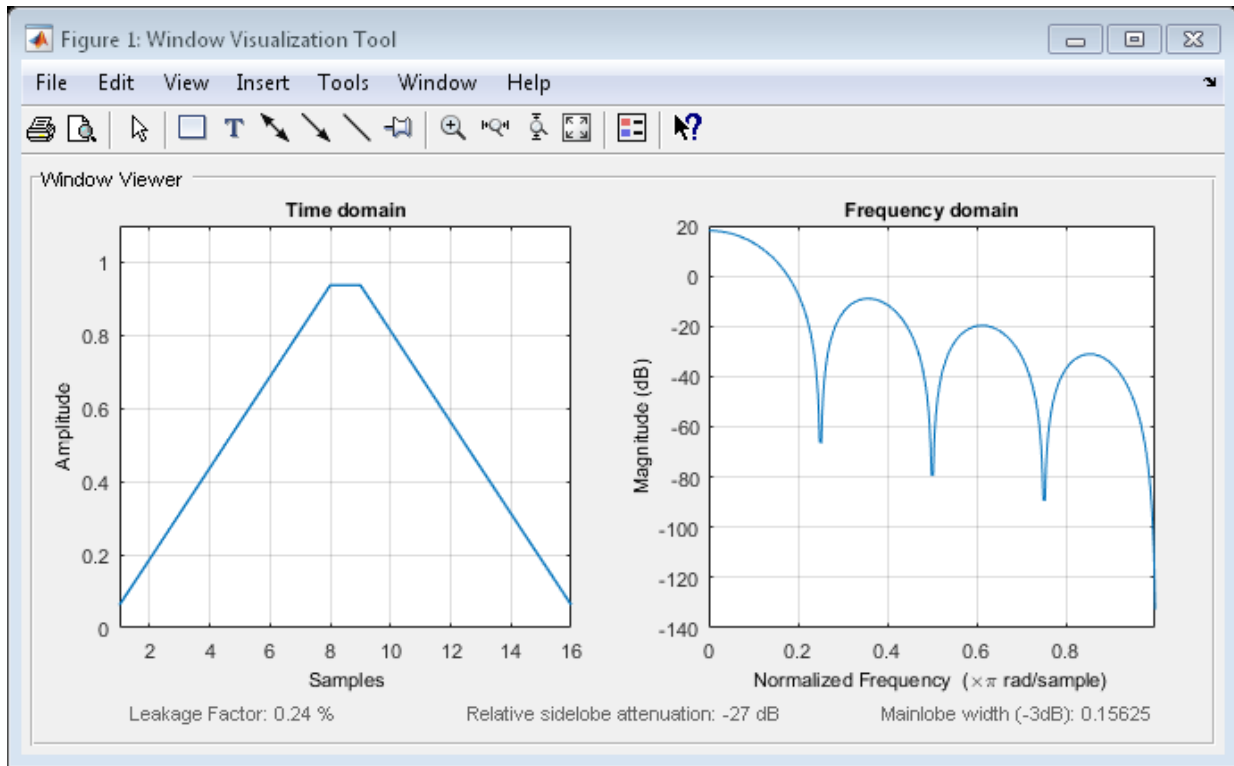

References

Oppenheim, Alan V., and Ronald W. Schaffer. *Discrete-Time Signal Processing*. Upper Saddle River, NJ: Prentice Hall, 1989.

See Also

See Also

triang | window | wvtool

Topics

“Windows”

Class Attributes (MATLAB)

Property Attributes (MATLAB)

generate

Class: sigwin.triang

Package: sigwin

Generates triangular window

Syntax

```
win = generate(H)
```

Description

`win = generate(H)` returns the values of the triangular window object `H` as a double-precision column vector.

Examples

Triangular Window

Generate a triangular window of length $N = 16$. Return its values as a column vector. Write the coefficients to an ASCII file in the current directory. Show information about the window object. Display the window.

```
H = sigwin.triang(16);
```

```
win = generate(H)
```

```
win =
```

```
0.0625  
0.1875  
0.3125  
0.4375  
0.5625  
0.6875
```

```
0.8125
0.9375
0.9375
0.8125
```

```
winwrite(H,'triang_16');
wininfo = info(H)
```

```
wininfo = 3×17 char array
    'Triangular Window'
    '-----'
    'Length : 16      '
```

```
wvtool(H)
```

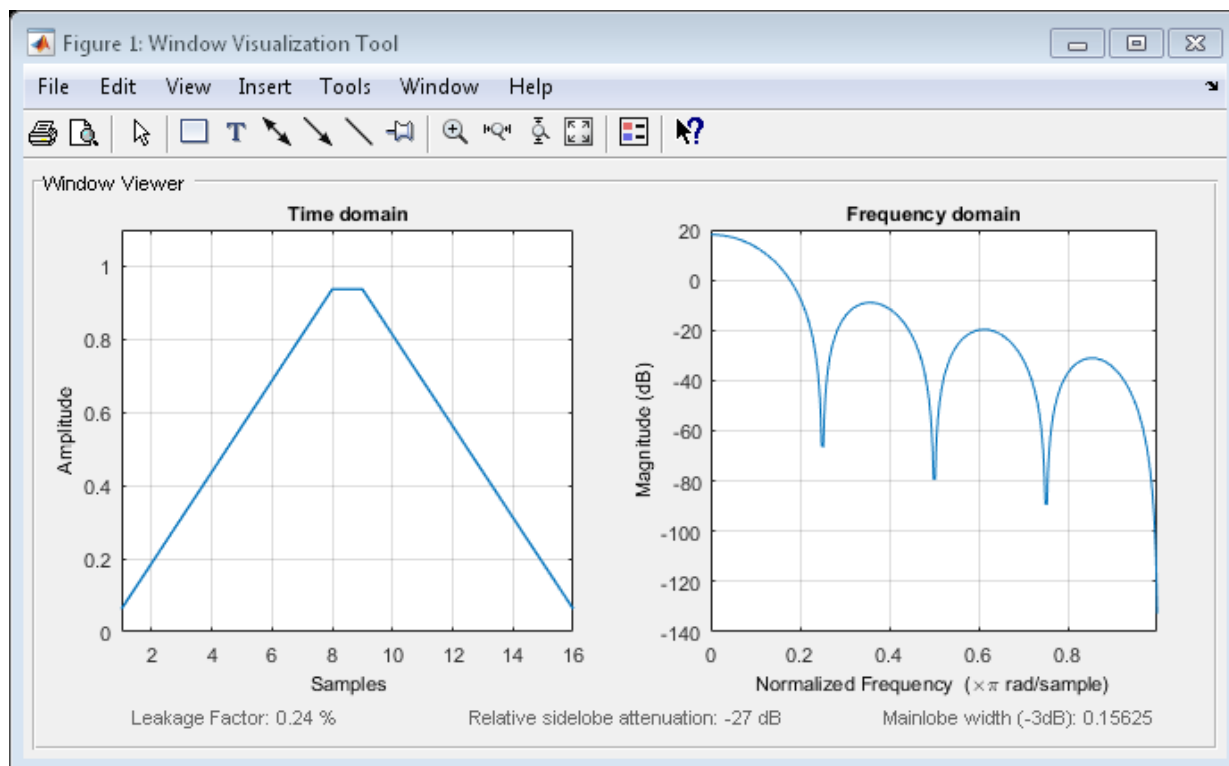

See Also

See Also

triang | window | wvtool

Topics

“Windows”

Class Attributes (MATLAB)

Property Attributes (MATLAB)

info

Class: sigwin.triang

Package: sigwin

Display information about triangular window

Syntax

```
info(H)  
info_array = info(H)
```

Description

`info(H)` displays length information for the triangular window object `H`.

`info_array = info(H)` returns length information for the triangular window object `H` in the character array `info_array`.

Examples

Triangular Window

Generate a triangular window of length $N = 16$. Return its values as a column vector. Write the coefficients to an ASCII file in the current directory. Show information about the window object. Display the window.

```
H = sigwin.triang(16);
```

```
win = generate(H)
```

```
win =
```

```
    0.0625  
    0.1875  
    0.3125  
    0.4375  
    0.5625
```



```

0.6875
0.8125
0.9375
0.9375
0.8125

```

```

winwrite(H,'triang_16');
wininfo = info(H)

wininfo = 3×17 char array
    'Triangular Window'
    '-----'
    'Length : 16      '

wvtool(H)

```

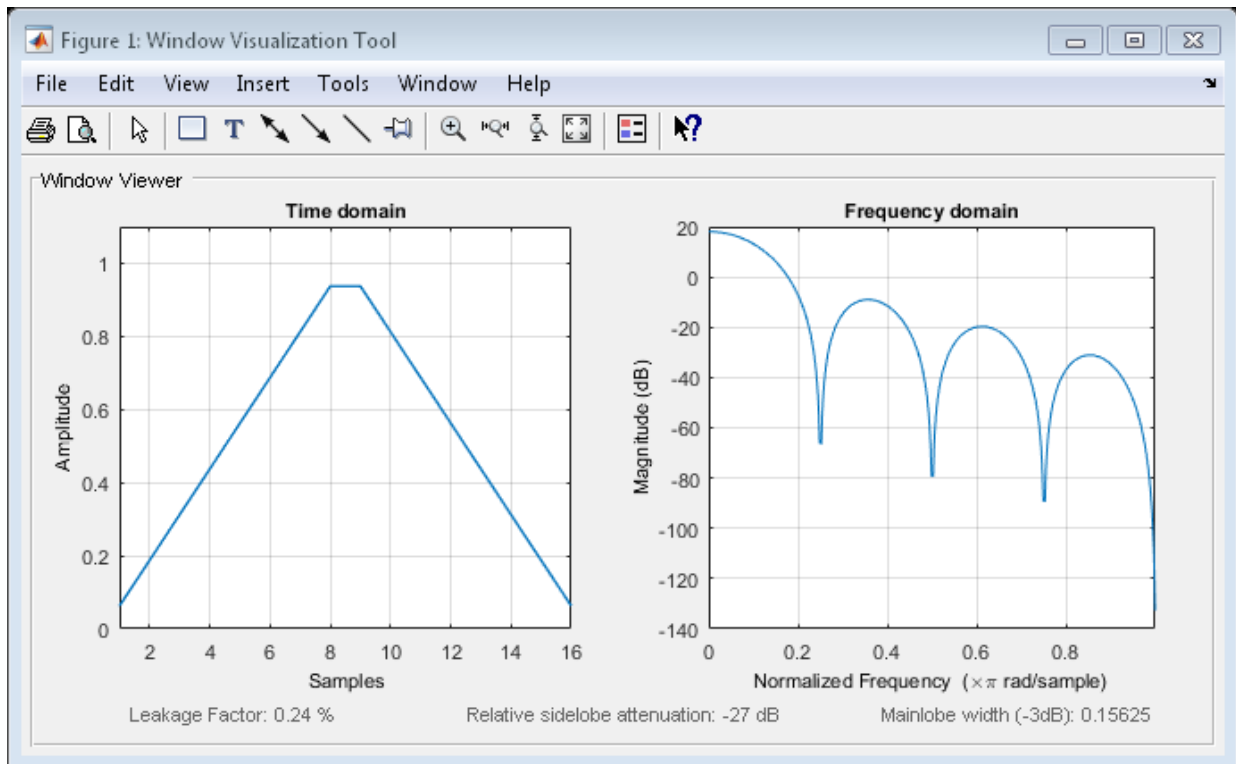

See Also

See Also

[triang](#) | [window](#) | [wvtool](#)

Topics

“Windows”

[Class Attributes \(MATLAB\)](#)

[Property Attributes \(MATLAB\)](#)

winwrite

Class: sigwin.triang

Package: sigwin

Save triangular window in ASCII file

Syntax

```
winwrite(H)
winwrite(H, 'filename')
```

Description

`winwrite(H)` opens a dialog to export the values of the triangular window object `H` to an ASCII file. The file extension `.wf` is automatically appended.

`winwrite(H, 'filename')` saves the values of the triangular window object `H` as a column vector in the ASCII file `'filename'` in the current folder. The file extension `.wf` is automatically appended to `filename`.

Examples

Triangular Window

Generate a triangular window of length $N = 16$. Return its values as a column vector. Write the coefficients to an ASCII file in the current directory. Show information about the window object. Display the window.

```
H = sigwin.triang(16);
```

```
win = generate(H)
```

```
win =
```

```
0.0625
0.1875
0.3125
0.4375
```

```
0.5625
0.6875
0.8125
0.9375
0.9375
0.8125
```

```
winwrite(H,'triang_16');
wininfo = info(H)
```

```
wininfo = 3×17 char array
    'Triangular Window'
    '-----'
    'Length : 16      '
```

```
wvtool(H)
```

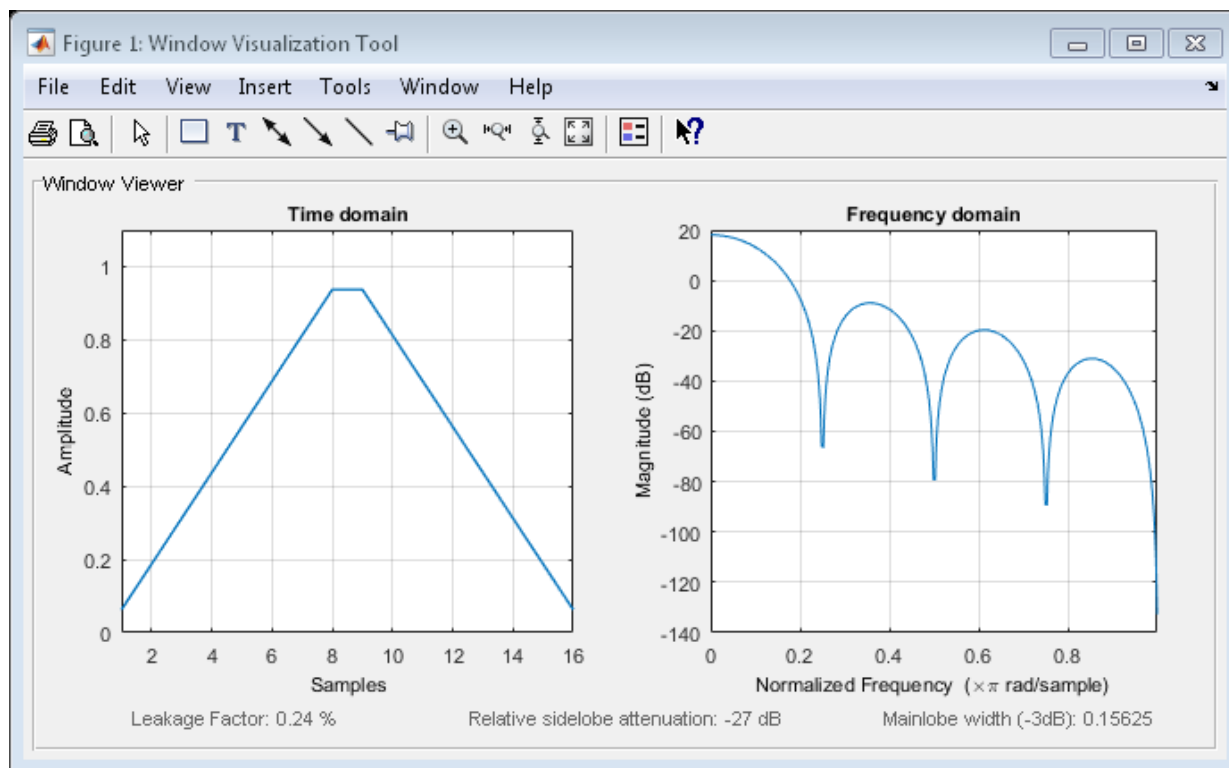

See Also

See Also

triang | window | wvtool

Topics

“Windows”

Class Attributes (MATLAB)

Property Attributes (MATLAB)

sigwin.tukeywin class

Package: sigwin

Construct Tukey window object

Description

Note: The use of `sigwin.tukeywin` is not recommended. Use `tukeywin` instead.

`sigwin.tukeywin` creates a handle to a Tukey window object for use in spectral analysis and FIR filtering by the window method. Object methods enable workspace import and ASCII file export of the window values.

The following equation defines the N -point Tukey window:

$$w(x) = \begin{cases} \frac{1}{2} \{1 + \cos(\frac{2\pi}{\alpha}[x - \alpha/2])\} & 0 \leq x < \frac{\alpha}{2} \\ 1 & \frac{\alpha}{2} \leq x < 1 - \frac{\alpha}{2} \\ \frac{1}{2} \{1 + \cos(\frac{2\pi}{\alpha}[x - 1 + \alpha/2])\} & 1 - \frac{\alpha}{2} \leq x \leq 1 \end{cases}$$

where x is a N -point linearly spaced vector generated using `linspace`. The parameter α is the ratio of cosine-tapered section length to the entire window length with $0 \leq \alpha \leq 1$. For example, setting $\alpha=0.5$ produces a Tukey window where 1/2 of the entire window length consists of segments of a phase-shifted cosine with period $2\alpha=1$. If you specify $\alpha \leq 0$, an N -point rectangular window is returned. If you specify $\alpha \geq 1$, a von Hann window (`sigwin.hann`) is returned.

Construction

`H = sigwin.tukeywin` returns a Tukey or cosine-tapered window object `H` of length 64 with *Alpha* parameter equal to 0.5.

`H = sigwin.tukeywin(Length)` returns a Tukey window object `H` of length *Length* with *Alpha* parameter equal to 0.5. *Length* requires a positive integer. Entering a positive noninteger value for *Length* rounds the length to the nearest integer.

`H = sigwin.tukeywin(Length,Alpha)` returns a Tukey window object with the ratio of the tapered section length to the entire window length *Alpha*. *Alpha* defaults to 0.5. As *Alpha* approaches zero, the Tukey window approaches a rectangular window. As *Alpha* approaches one, the Tukey window approaches a Hann window.

Properties

Length

Tukey window length. The window length must be a positive integer. Entering a positive noninteger value for *Length* rounds the length to the nearest integer. Entering a 1 for *Length* results in a window with a single value of 1.

Alpha

The ratio of tapered window section to constant section. As a ratio, *Alpha* satisfies the inequality $0 \leq \alpha \leq 1$. As *Alpha* approaches zero, the Tukey window approaches a rectangular window. As *Alpha* approaches one, the Tukey window approaches a Hann window. Specifying *Alpha* less than zero or greater than one replaces *Alpha* with 0 and 1 respectively.

Methods

<code>generate</code>	Generates Tukey window
<code>info</code>	Display information about Tukey window object
<code>winwrite</code>	Save Tukey window in ASCII file

Copy Semantics

Handle. To learn how copy semantics affect your use of the class, see Copying Objects (MATLAB) in the MATLAB Programming Fundamentals documentation.

Examples

Tukey Windows

Generate two Tukey windows of length $N = 64$:

- The first window has $\alpha = 1/4$. α is the ratio of tapered window section length to constant section length.
- The second window has $\alpha = 3/4$.

Display the two windows.

```
H14 = sigwin.tukeywin(64,1/4);  
H34 = sigwin.tukeywin(64,3/4);  
  
wvt = wvtool(H14,H34);  
legend(wvt.CurrentAxes, '\alpha = 1/4', '\alpha = 3/4')
```

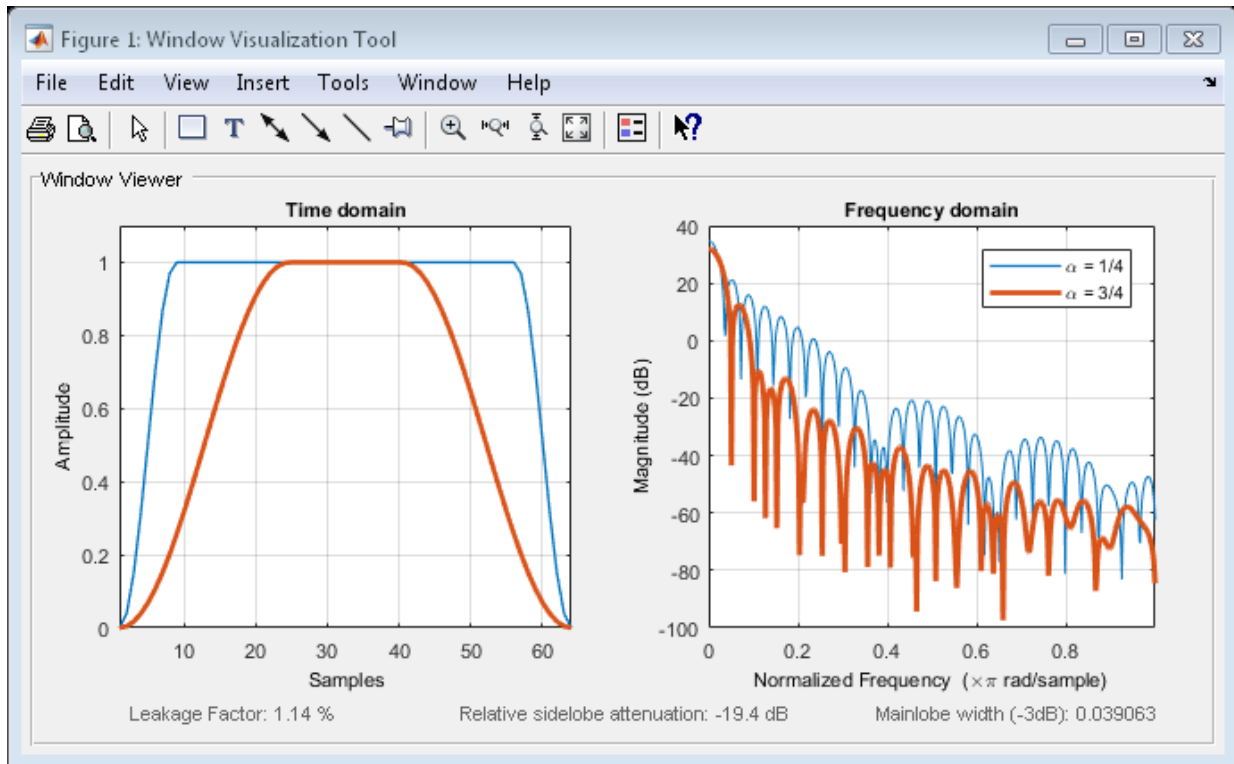
Generate a Tukey window with length $N = 16$ and the default $\alpha = 1/2$; Return its values as a column vector. Write the coefficients to an ASCII file in the current directory. Show information about the window object. Display the window.

```
H = sigwin.tukeywin(16);
```

```
win = generate(H)
```

```
win =
```

```

0
0.1654
0.5523
0.9045
1.0000
1.0000
1.0000
```

```
1.0000
1.0000
1.0000
```

```
winwrite(H, 'tukeywin_16');
wininfo = info(H)
```

```
wininfo = 4x13 char array
    'Tukey Window '
    '-----'
    'Length   : 16 '
    'Alpha    : 0.5'
```

```
wvtool(H)
```

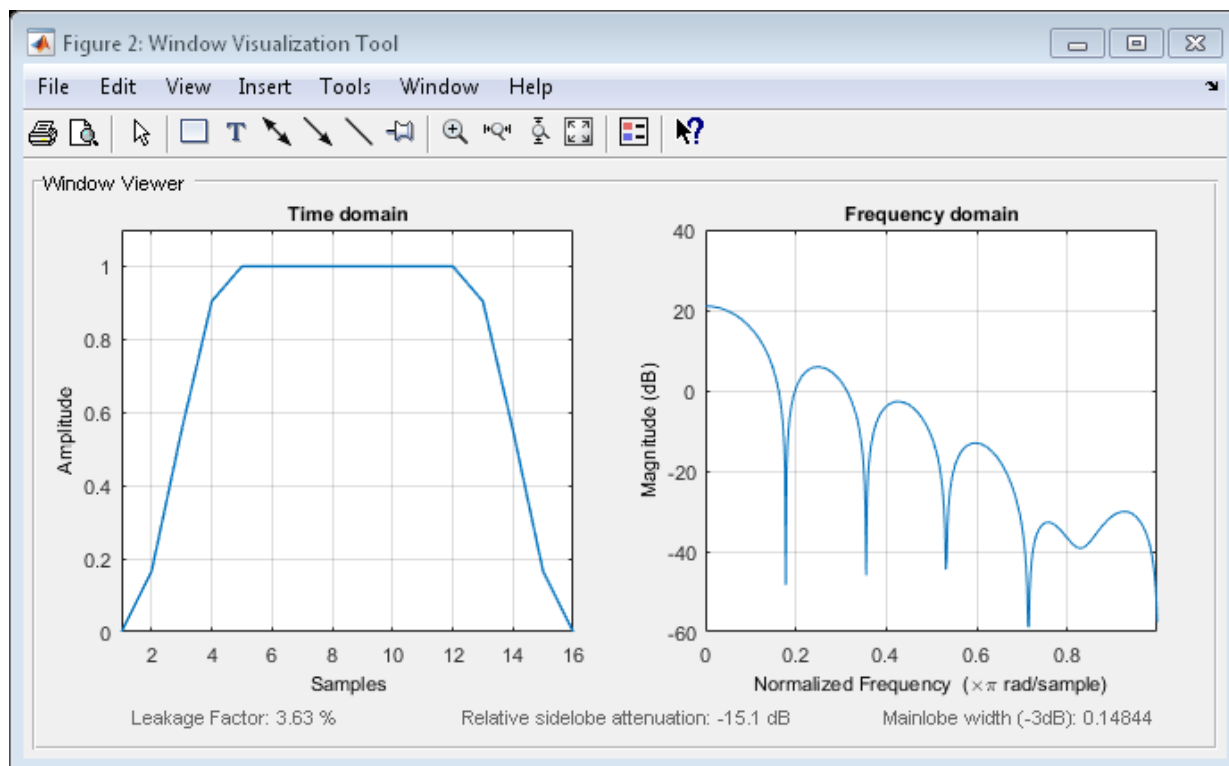

References

- [1] Bloomfield, P. *Fourier Analysis of Time Series: An Introduction*. New York: Wiley-Interscience, 2000.

See Also

See Also

tukeywin | window | wvtool

Topics

“Windows”

Class Attributes (MATLAB)

Property Attributes (MATLAB)

generate

Class: sigwin.tukeywin

Package: sigwin

Generates Tukey window

Syntax

```
win = generate(H)
```

Description

`win = generate(H)` returns the values of the Tukey window object `H` as a double-precision column vector.

Examples

Tukey Windows

Generate two Tukey windows of length $N = 64$:

- The first window has $\alpha = 1/4$. α is the ratio of tapered window section length to constant section length.
- The second window has $\alpha = 3/4$.

Display the two windows.

```
H14 = sigwin.tukeywin(64,1/4);
```

```
H34 = sigwin.tukeywin(64,3/4);
```

```
wvt = wvtool(H14,H34);
```

```
legend(wvt.CurrentAxes, '\alpha = 1/4', '\alpha = 3/4')
```

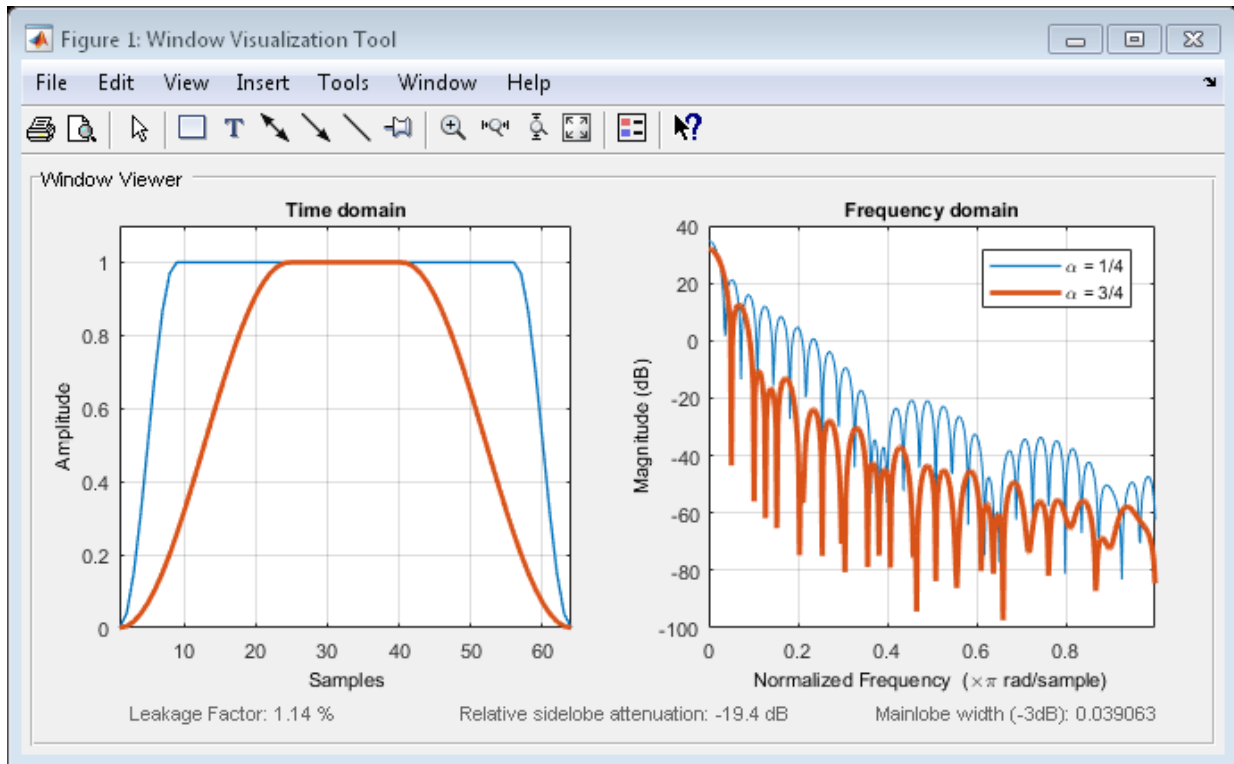

Generate a Tukey window with length $N = 16$ and the default $\alpha = 1/2$; Return its values as a column vector. Write the coefficients to an ASCII file in the current directory. Show information about the window object. Display the window.

```
H = sigwin.tukeywin(16);
```

```
win = generate(H)
```

```
win =
```

```

0
0.1654
0.5523
0.9045
1.0000
1.0000
1.0000
```

```

1.0000
1.0000
1.0000

winwrite(H,'tukeywin_16');
wininfo = info(H)

wininfo = 4x13 char array
'Tukey Window '
'-----'
'Length   : 16 '
'Alpha    : 0.5 '

wvtool(H)

```

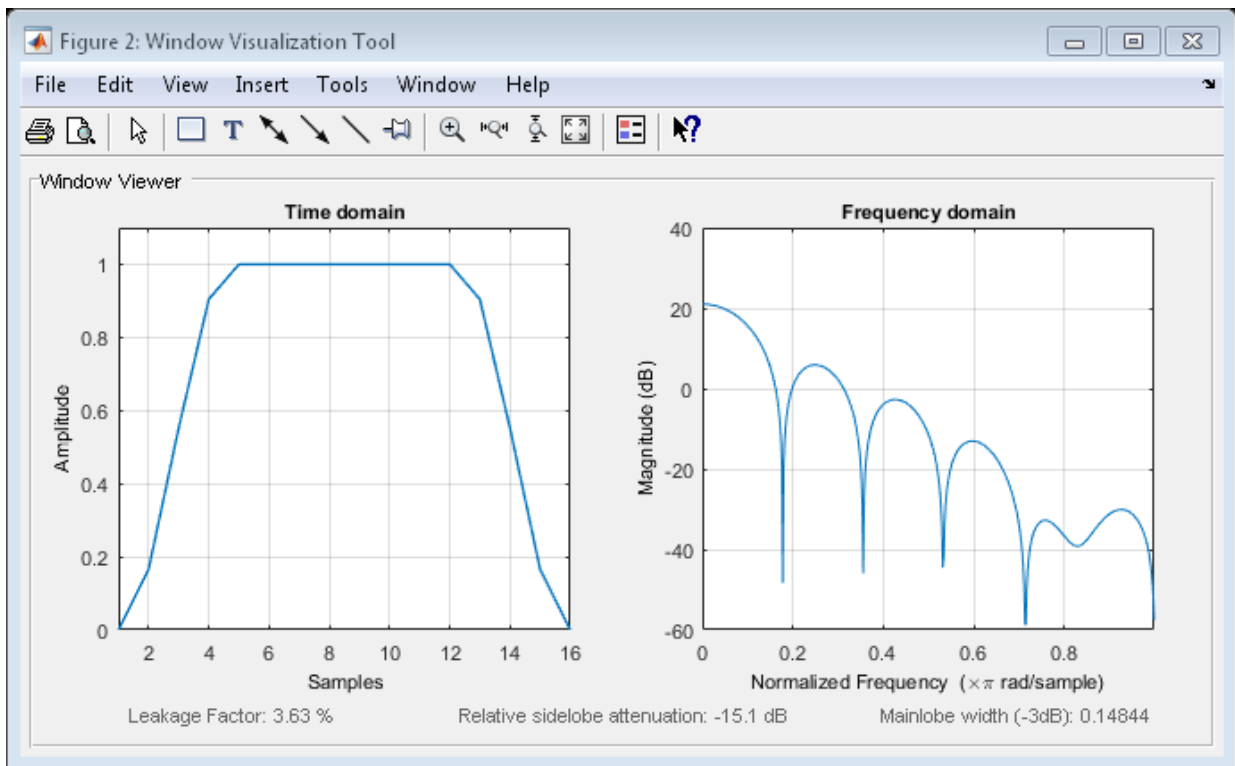

See Also

See Also

tukeywin | window | wvtool

Topics

“Windows”

Class Attributes (MATLAB)

Property Attributes (MATLAB)

info

Class: sigwin.tukeywin

Package: sigwin

Display information about Tukey window object

Syntax

```
info(H)  
info_win = info(H)
```

Description

`info(H)` displays length and tapered-to-constant section ratio information for the Tukey window object `H`.

`info_win = info(H)` returns length and tapered-to-constant section ratio information for the Tukey window object `H` in the character array `info_win`.

Examples

Tukey Windows

Generate two Tukey windows of length $N = 64$:

- The first window has $\alpha = 1/4$. α is the ratio of tapered window section length to constant section length.
- The second window has $\alpha = 3/4$.

Display the two windows.

```
H14 = sigwin.tukeywin(64,1/4);  
H34 = sigwin.tukeywin(64,3/4);  
  
wvt = wvtool(H14,H34);
```



```
legend(wvt.CurrentAxes, '\alpha = 1/4', '\alpha = 3/4')
```

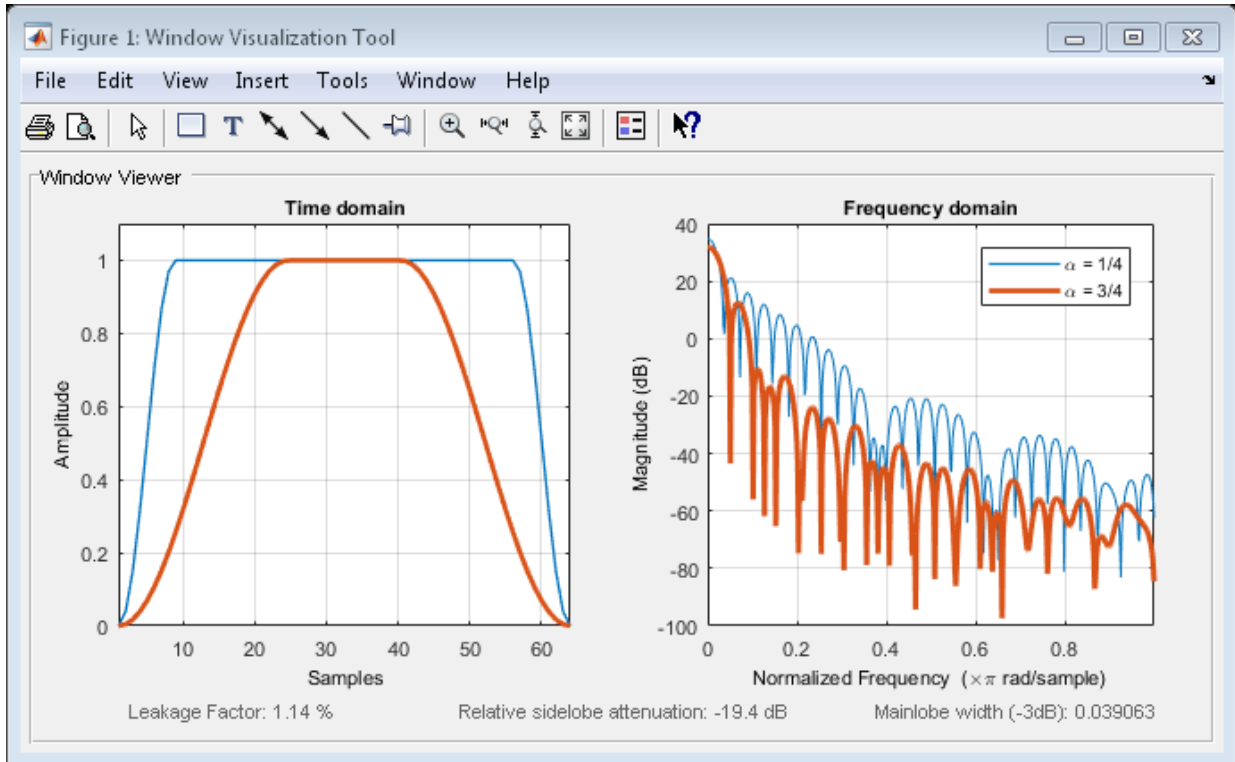

Generate a Tukey window with length $N = 16$ and the default $\alpha = 1/2$; Return its values as a column vector. Write the coefficients to an ASCII file in the current directory. Show information about the window object. Display the window.

```
H = sigwin.tukeywin(16);
```

```
win = generate(H)
```

```
win =
```

```

    0
    0.1654
    0.5523
    0.9045
    1.0000
```

```
1.0000
1.0000
1.0000
1.0000
1.0000
```

```
winwrite(H,'tukeywin_16');
wininfo = info(H)
```

```
wininfo = 4×13 char array
    'Tukey Window '
    '-----'
    'Length  : 16 '
    'Alpha   : 0.5'
```

```
wvtool(H)
```

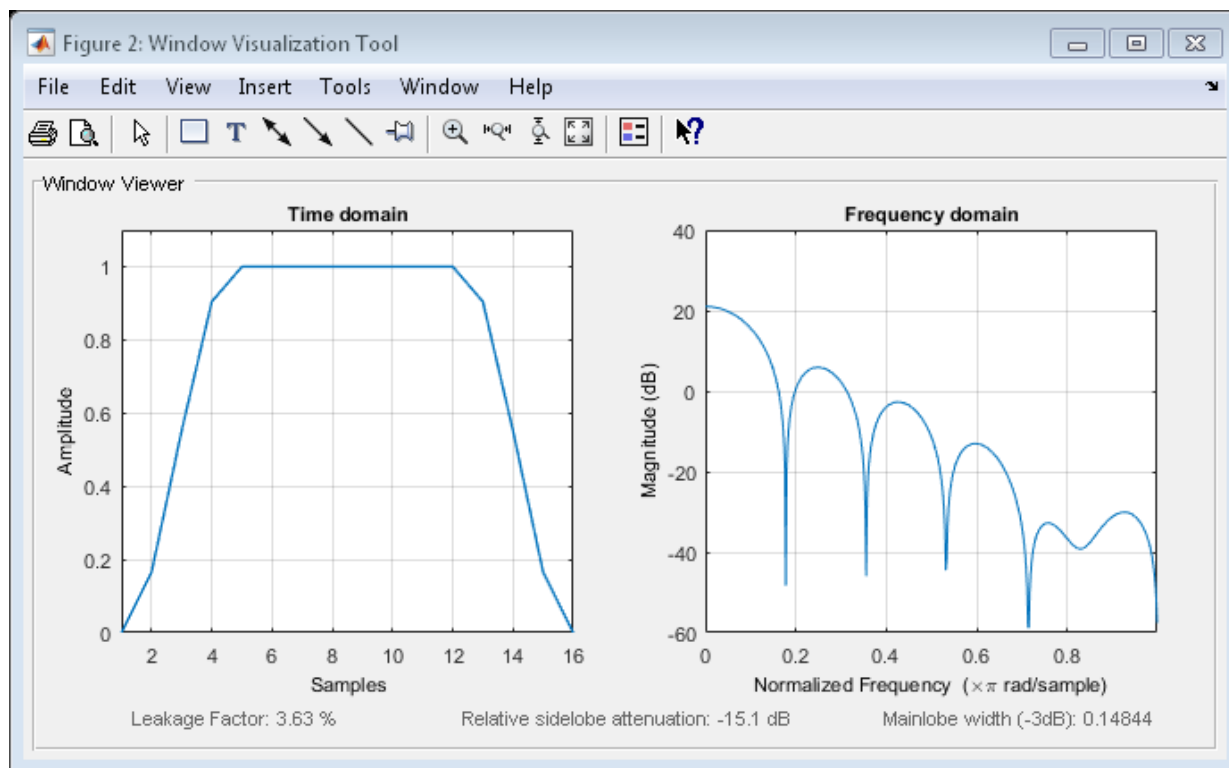

See Also

See Also

`tukeywin` | `window` | `wvtool`

Topics

“Windows”

Class Attributes (MATLAB)

Property Attributes (MATLAB)

winwrite

Class: sigwin.tukeywin

Package: sigwin

Save Tukey window in ASCII file

Syntax

```
winwrite(H)
winwrite(H, 'filename')
```

Description

`winwrite(H)` opens a dialog to export the values of the Tukey window object to an ASCII file. The file extension `.wf` is automatically appended.

`winwrite(H, 'filename')` saves the values of the Tukey window object `H` in the current folder as a column vector in the ASCII file `'filename'`. The file extension `.wf` is automatically appended to `filename`.

Examples

Tukey Windows

Generate two Tukey windows of length $N = 64$:

- The first window has $a = 1/4$. a is the ratio of tapered window section length to constant section length.
- The second window has $a = 3/4$.

Display the two windows.

```
H14 = sigwin.tukeywin(64,1/4);
H34 = sigwin.tukeywin(64,3/4);
```

```
wvt = wvtool(H14,H34);
```

```
legend(wvt.CurrentAxes, '\alpha = 1/4', '\alpha = 3/4')
```

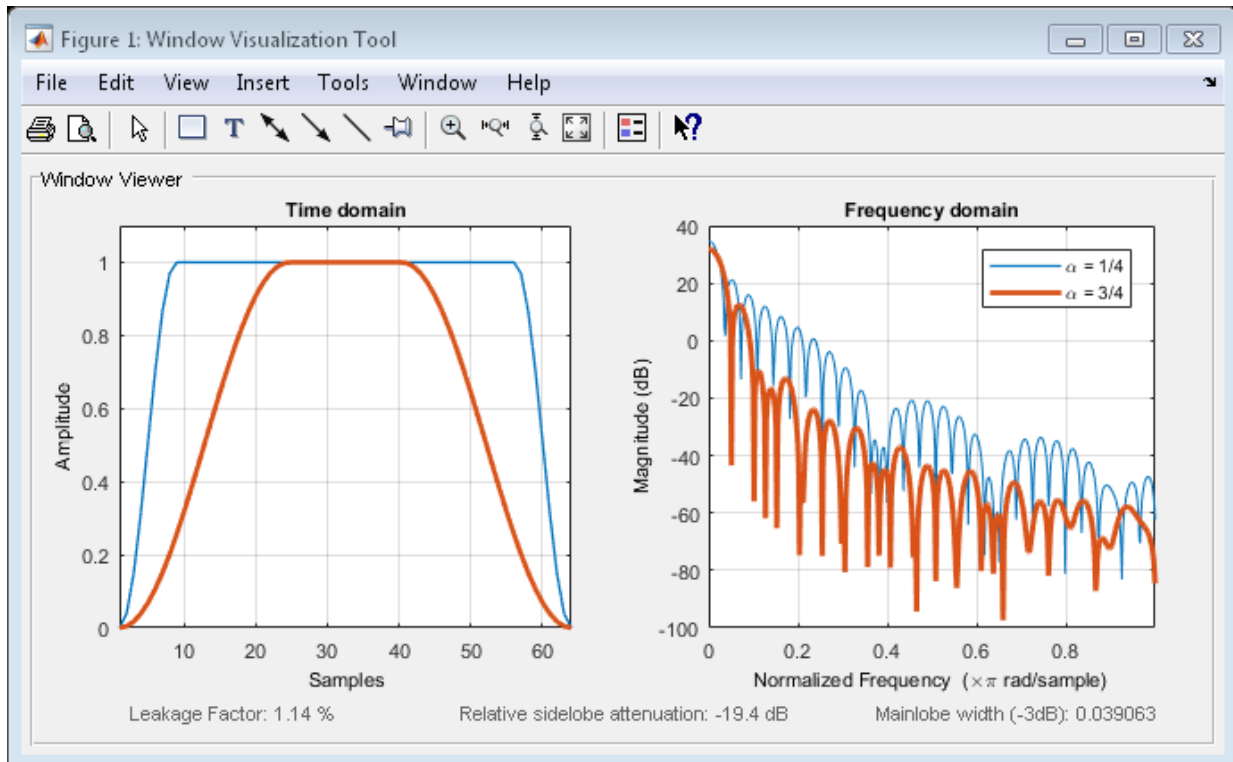

Generate a Tukey window with length $N = 16$ and the default $\alpha = 1/2$; Return its values as a column vector. Write the coefficients to an ASCII file in the current directory. Show information about the window object. Display the window.

```
H = sigwin.tukeywin(16);
```

```
win = generate(H)
```

```
win =
```

```

0
0.1654
0.5523
0.9045
1.0000
```

```
1.0000
1.0000
1.0000
1.0000
1.0000
```

```
winwrite(H,'tukeywin_16');
wininfo = info(H)
```

```
wininfo = 4×13 char array
    'Tukey Window '
    '-----'
    'Length   : 16 '
    'Alpha    : 0.5'
```

```
wvtool(H)
```

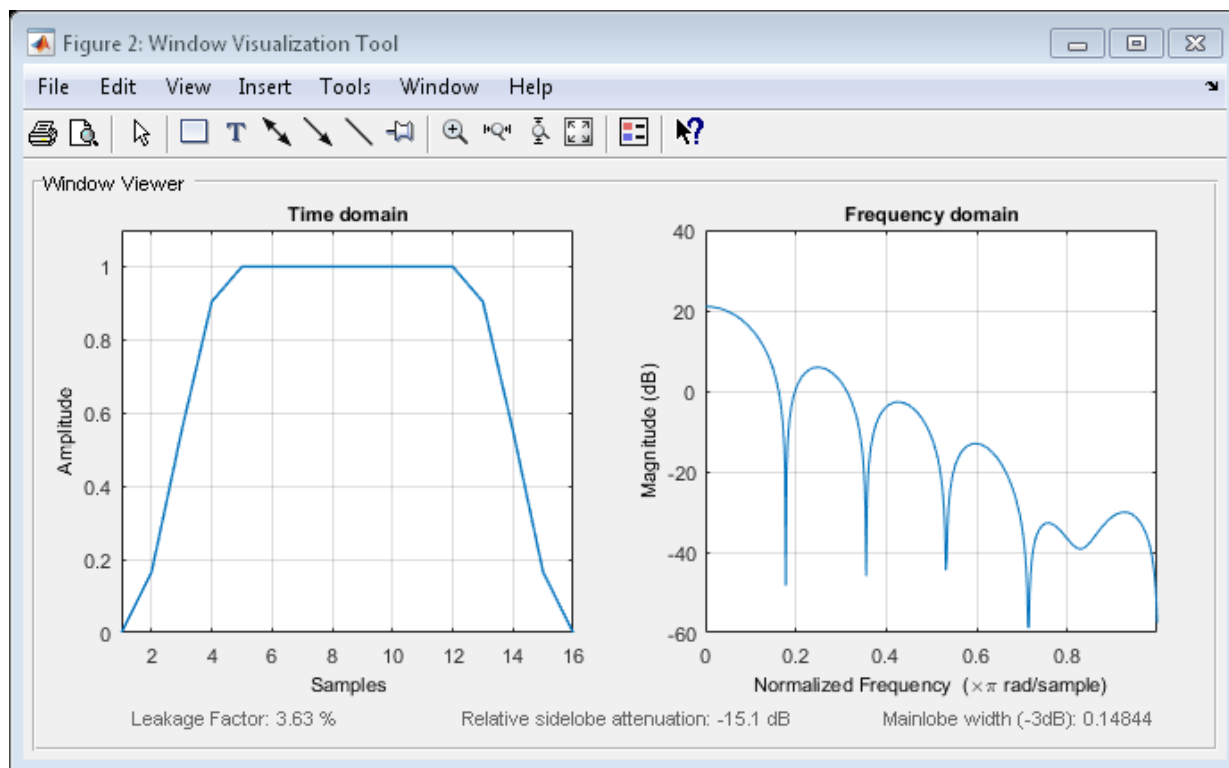

See Also

See Also

tukeywin | window | wvtool

Topics

“Windows”

Class Attributes (MATLAB)

Property Attributes (MATLAB)

sinad

Signal to noise and distortion ratio

Syntax

```
r = sinad(x)
r = sinad(x,fs)

r = sinad(pxx,f,'psd')

r = sinad(sxx,f,rbw,'power')

[r,totdistpow] = sinad(____)

sinad(____)
```

Description

`r = sinad(x)` returns the signal to noise and distortion ratio (SINAD) in dBc of the real-valued sinusoidal signal `x`. The SINAD is determined using a modified periodogram of the same length as the input signal. The modified periodogram uses a Kaiser window with $\beta = 38$.

`r = sinad(x,fs)` specifies the sample rate `fs` of the input signal `x`. If you do not specify `fs`, then the sample rate defaults to 1.

`r = sinad(pxx,f,'psd')` specifies the input `pxx` as a one-sided power spectral density (PSD) estimate. `f` is a vector of frequencies corresponding to the PSD estimates in `pxx`.

`r = sinad(sxx,f,rbw,'power')` specifies the input as a one-sided power spectrum. `rbw` is the resolution bandwidth over which each power estimate is integrated.

`[r,totdistpow] = sinad(____)` returns the total noise and harmonic distortion power (in dB) of the signal.

`sinad(___)` with no output arguments plots the spectrum of the signal in the current figure window and labels its fundamental component. It uses different colors to draw the fundamental component, the DC value, and the noise. The SINAD appears above the plot.

Examples

SINAD for Signal with One Harmonic or One Harmonic Plus Noise

Create two signals. Both signals have a fundamental frequency of $\pi/4$ rad/sample with amplitude 1 and the first harmonic of frequency $\pi/2$ rad/sample with amplitude 0.025. One of the signals additionally has additive white Gaussian noise with variance 0.05^2 .

Create the two signals. Set the random number generator to the default settings for reproducible results. Determine the SINAD for the signal without additive noise and compare the result to the theoretical SINAD.

```
n = 0:159;
x = cos(pi/4*n)+0.025*sin(pi/2*n);
rng default

y = cos(pi/4*n)+0.025*sin(pi/2*n)+0.05*randn(size(n));
r = sinad(x)

r = 32.0412

powfund = 1;
powharm = 0.025^2;
thSINAD = 10*log10(powfund/powharm)

thSINAD = 32.0412
```

Determine the SINAD for the sinusoidal signal with additive noise. Show how including the theoretical variance of the additive noise approximates the SINAD.

```
r = sinad(y)

r = 22.8085

varnoise = 0.05^2;
```

```
thSINAD = 10*log10(powfund/(powharm+varnoise))  
thSINAD = 25.0515
```

SINAD for Signal with Sample Rate

Create a signal with a fundamental frequency of 1 kHz and unit amplitude, sampled at 480 kHz. The signal additionally consists of the first harmonic with amplitude 0.02 and additive white Gaussian noise with variance 0.01^2 .

Determine the SINAD and compare the result with the theoretical SINAD.

```
fs = 48e4;  
t = 0:1/fs:1-1/fs;  
rng default  
  
x = cos(2*pi*1000*t)+0.02*sin(2*pi*2000*t)+0.01*randn(size(t));  
r = sinad(x,fs)  
  
r = 32.2058  
  
powfund = 1;  
powharm = 0.02^2;  
varnoise = 0.01^2;  
thSINAD = 10*log10(powfund/(powharm+varnoise*(1/fs)))  
  
thSINAD = 33.9794
```

SINAD from Periodogram

Create a signal with a fundamental frequency of 1 kHz and unit amplitude, sampled at 480 kHz. The signal additionally consists of the first harmonic with amplitude 0.02 and additive white Gaussian noise with standard deviation 0.01. Set the random number generator to the default settings for reproducible results.

Obtain the periodogram of the signal and use the periodogram as the input to `sinad`.

```
fs = 48e4;  
t = 0:1/fs:1-1/fs;  
rng default  
x = cos(2*pi*1000*t)+0.02*sin(2*pi*2000*t)+0.01*randn(size(t));
```

```
[pxx,f] = periodogram(x,rectwin(length(x)),length(x),fs);  
r = sinad(pxx,f,'psd')  
  
r = 32.2109
```

SINAD of Amplified Signal

Generate a sinusoid of frequency 2.5 kHz sampled at 50 kHz. Add Gaussian white noise with standard deviation 0.00005 to the signal. Pass the result through a weakly nonlinear amplifier. Plot the SINAD.

```
fs = 5e4;  
f0 = 2.5e3;  
N = 1024;  
t = (0:N-1)/fs;  
  
ct = cos(2*pi*f0*t);  
cd = ct + 0.00005*randn(size(ct));  
  
amp = [1e-5 5e-6 -1e-3 6e-5 1 25e-3];  
sgn = polyval(amp,cd);  
  
sinad(sgn,fs);
```

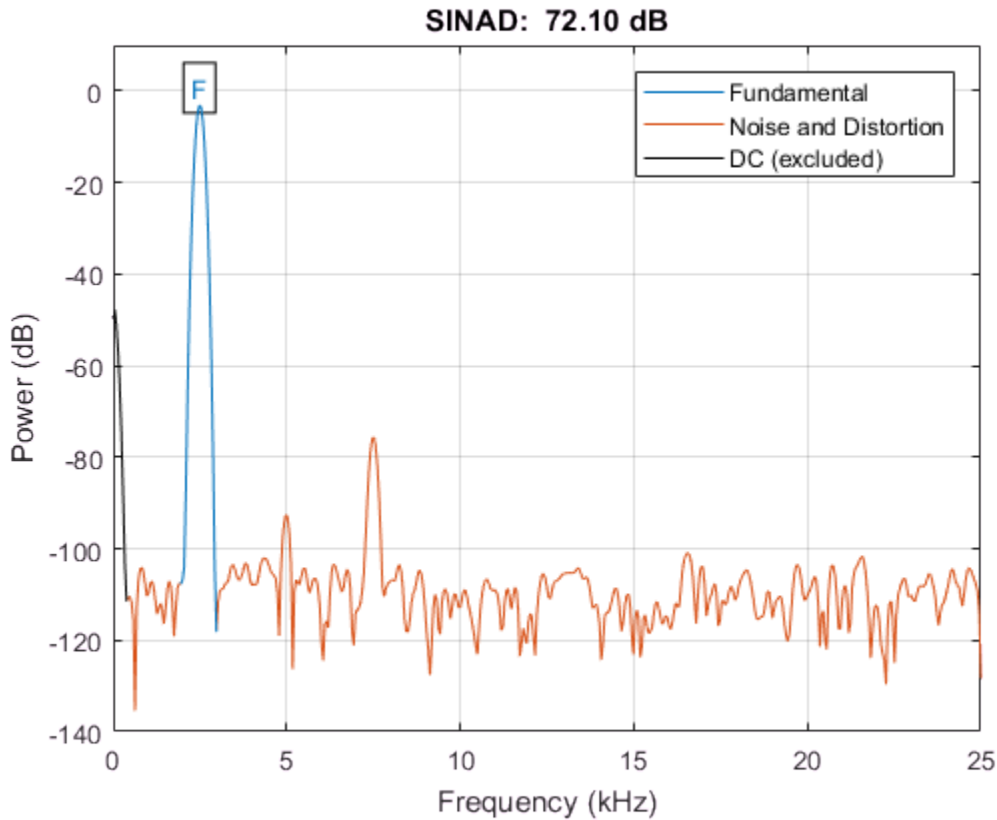

The plot shows the spectrum used to compute the ratio and the region treated as noise. The DC level and the fundamental are excluded from the noise computation. The fundamental is labeled.

- “Analyzing Harmonic Distortion”

Input Arguments

x — Real-valued sinusoidal input signal
vector

Real-valued sinusoidal input signal, specified as a row or column vector.

Example: `cos(pi/4*(0:159))+cos(pi/2*(0:159))`

Data Types: `single` | `double`

fs — Sample rate

positive scalar

Sample rate, specified as a positive scalar. The sample rate is the number of samples per unit time. If the unit of time is seconds, then the sample rate has units of Hz.

pxx — One-sided PSD estimate

vector

One-sided PSD estimate, specified as a real-valued, nonnegative column vector.

Data Types: `single` | `double`

f — Cyclical frequencies

vector

Cyclical frequencies corresponding to the one-sided PSD estimate, `pxx`, specified as a row or column vector. The first element of `f` must be 0.

Data Types: `double` | `single`

sxx — Power spectrum

nonnegative real-valued row or column vector

Power spectrum, specified as a real-valued nonnegative row or column vector.

rbw — Resolution bandwidth

positive scalar

Resolution bandwidth, specified as a positive scalar. The resolution bandwidth is the product of the frequency resolution of the discrete Fourier transform and the equivalent noise bandwidth of the window.

Output Arguments

r — Signal to noise and distortion ratio in dBc

real-valued scalar

Signal to noise and distortion ratio in dBc, returned as a real-valued scalar.

totdistpow — Total noise and harmonic distortion power of the signal

real-valued scalar

Total noise and harmonic distortion power of the signal, returned as a real-valued scalar expressed in dB.

Definitions

Distortion Measurement Functions

The functions `thd`, `sfdr`, `sinad`, and `snr` measure the response of a weakly nonlinear system stimulated by a sinusoid.

When given time-domain input, `sinad` performs a periodogram using a Kaiser window with large sidelobe attenuation. To find the fundamental frequency, the algorithm searches the periodogram for the largest nonzero spectral component. It then computes the central moment of all adjacent bins that decrease monotonically away from the maximum. To be detectable, the fundamental should be at least in the second frequency bin. Higher harmonics are at integer multiples of the fundamental frequency. If a harmonic lies within the monotonically decreasing region in the neighborhood of another, its power is considered to belong to the larger harmonic. This larger harmonic may or may not be the fundamental.

The function estimates a noise level using the median power in the regions containing only noise and distortion. The DC component is excluded from the calculation. The noise at each point is the estimated level or the ordinate of the point, whichever is smaller. The noise is then subtracted from the values of the signal and the harmonics.

`sinad` fails if the fundamental is not the highest spectral component in the signal.

Ensure that the frequency components are far enough apart to accommodate for the sidelobe width of the Kaiser window. If this is not feasible, you can use the `'power'` flag and compute a periodogram with a different window.

See Also

See Also

`sfdr` | `snr` | `thd` | `toi`

Topics

“Analyzing Harmonic Distortion”

Introduced in R2013b

sinc

Sinc function

Syntax

```
y = sinc(x)
```

Description

`y = sinc(x)` returns an array, `y`, whose elements are the “sinc” on page 1-2132 of the elements of the input, `x`. `y` is the same size as `x`.

Input Arguments

x — Input array

scalar value | vector | matrix | N-D array | `gpuArray` object

Input array, specified as a real-valued or complex-valued scalar, vector, matrix, N-D array, or `gpuArray` object. When `x` is nonscalar, `sinc` is an element-wise operation.

See “GPU Computing” (Parallel Computing Toolbox) and GPU System Requirements for details on `gpuArray` objects.

Data Types: `single` | `double`

Complex Number Support: Yes

Output Arguments

y — Sinc of input

scalar value | vector | matrix | N-D array | `gpuArray` object

Sinc of the input array, `x`, returned as a real-valued or complex-valued scalar, vector, matrix, N-D array, or `gpuArray` object of the same size as `x`.

Examples

Ideal Bandlimited Interpolation

Perform ideal bandlimited interpolation of a random signal sampled at integer spacings.

Assume that the signal to interpolate, x , is 0 outside of the given time interval and has been sampled at the Nyquist frequency. Reset the random number generator for reproducibility.

```
rng default

t = 1:10;
x = randn(size(t))';
ts = linspace(-5,15,600);
[Ts,T] = ndgrid(ts,t);
y = sinc(Ts - T)*x;

plot(t,x,'o',ts,y)
xlabel Time, ylabel Signal
legend('Sampled','Interpolated','Location','SouthWest')
legend boxoff
```

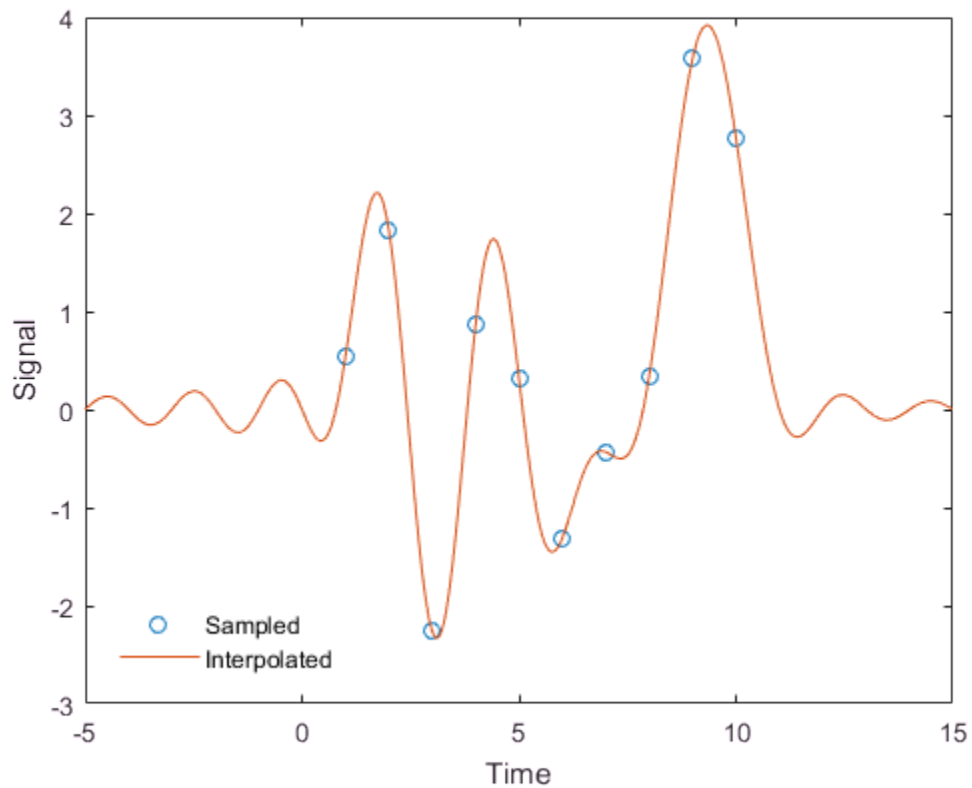

Definitions

sinc

The sinc function is defined by

$$\operatorname{sinc} t = \begin{cases} \frac{\sin \pi t}{\pi t} & t \neq 0, \\ 1 & t = 0. \end{cases}$$

This analytic expression corresponds to the continuous inverse Fourier transform of a rectangular pulse of width 2π and height 1:

$$\text{sinc } t = \frac{1}{2\pi} \int_{-\pi}^{\pi} e^{j\omega t} d\omega.$$

The space of functions bandlimited in the frequency range $\omega = (-\pi, \pi]$ is spanned by the countably infinite set of sinc functions shifted by integers. Thus, you can reconstruct any such bandlimited function $g(t)$ from its samples at integer spacings:

$$g(t) = \sum_{n=-\infty}^{\infty} g(n) \text{sinc}(t - n).$$

Extended Capabilities

C/C++ Code Generation

Generate C and C++ code using MATLAB® Coder™.

See Also

See Also

chirp | cos | diric | gauspuls | pulstran | rectpuls | sawtooth | sin | square | tripuls

Introduced before R2006a

single

Cast coefficients of digital filter to single precision

Syntax

```
f2 = single(f1)
```

Description

`f2 = single(f1)` casts coefficients in a digital filter, `f1`, to single precision and returns a new digital filter, `f2`, that contains these coefficients. This is the only way that you can create single-precision `digitalFilter` objects.

Examples

Lowpass FIR Filter in Double and Single Precision

Use `designfilt` to design a 5th-order FIR lowpass filter. Specify a normalized passband frequency of 0.2π rad/sample and a normalized stopband frequency of 0.55π rad/sample. Cast the filter coefficients to single precision.

```
format long
d = designfilt('lowpassfir','FilterOrder',5, ...
              'PassbandFrequency',0.2,'StopbandFrequency', 0.55);
e = single(d);
classd = class(d.Coefficients)

classd =
'double'

classe = class(e.Coefficients)

classe =
'single'
```

Input Arguments

f1 — Digital filter

`digitalFilter` object

Digital filter, specified as a `digitalFilter` object. Use `designfilt` to generate `f1` based on frequency-response specifications.

Example: `d = designfilt('lowpassiir','FilterOrder',3,'HalfPowerFrequency',0.5)` specifies a third-order Butterworth filter with normalized 3-dB frequency 0.5π rad/sample.

Output Arguments

f2 — Single-precision digital filter

`digitalFilter` object

Single-precision digital filter, returned as a `digitalFilter` object.

See Also

See Also

`designfilt` | `digitalFilter` | `double` | `isdouble` | `issingle`

Introduced in R2014a

slewrates

Slew rate of bilevel waveform

Syntax

```
S = slewrates(X)
S = slewrates(X,Fs)
S = slewrates(X,T)
[S,LT,UT] = slewrates(...)
[S,LT,UT,LL,UL] = slewrates(...)
S = slewrates(...,Name,Value)
slewrates(...)
```

Description

`S = slewrates(X)` returns the slew rate for all transitions found in the bilevel waveform, `X`. The slew rate is the slope of the line connecting the 10% and 90% reference levels. The sample instants of `X` are the indices of the vector. To determine the transitions, `slewrates` estimates the state levels of the input waveform by a histogram method. `slewrates` identifies all regions that cross the upper-state boundary of the low state and the lower-state boundary of the high state. The low-state and high-state boundaries are expressed as the state level plus or minus a multiple of the difference between the state levels. See “State-Level Tolerances” on page 1-2145.

`S = slewrates(X,Fs)` specifies the sample rate, `Fs`, in hertz. The first time instant in `X` corresponds to `t=0`.

`S = slewrates(X,T)` specifies the sample instants in the vector, `T`. The length of `T` must equal the length of `X`.

`[S,LT,UT] = slewrates(...)` returns the time instants when the waveform crosses the lower-percent reference level, `LT`, and upper-percent reference level, `UT`. If you do not specify lower- and upper-percent reference levels, the levels default to 10% and 90%.

`[S,LT,UT,LL,UL] = slewrates(...)` returns the waveform values that correspond to the lower-reference levels, `LL`, and upper-reference levels, `UL`.

`S = slewrates(...,Name,Value)` returns the slew rate for all transitions with additional options specified by one or more `Name,Value` pair arguments.

`slewrates(...)` plots the bilevel waveform and darkens the regions of each transition where the slew rate is computed. The plot marks the lower- and upper-reference level crossings and associated reference levels. The plot indicates the state levels and associated lower and upper tolerances.

Input Arguments

X

Bilevel waveform as a real-valued column or row vector. If the input waveform does not have at least one transition, `slewrates` returns an empty matrix.

Fs

Sampling rate in hertz.

T

Vector of sample instants. The length of `T` must equal the length of the bilevel waveform, `X`.

Name-Value Pair Arguments

'PercentReferenceLevels'

Percent reference levels. See “Percent Reference Levels” on page 1-2144 for a definition.

Default: [10,90]

'StateLevels'

Low- and high-state levels. `StateLevels` is a 1-by-2 real-valued vector. The first element is the low-state level. The second element is the high-state level. If you do not specify low- and high-state levels, `slewrates` estimates the state levels from the input waveform using the histogram method.

'Tolerance'

Tolerance levels (lower and upper state boundaries) expressed as a percentage. See “State-Level Tolerances” on page 1-2145.

Default: 2

Output Arguments

S

Slew rates as real-valued scalars. A positive slew rate indicates that the upper-percent reference level occurs later than the lower-percent reference level. A negative slew rate indicates that the upper-percent reference level occurs before the lower-percent reference level.

LT

Time instants when signal crosses the lower percent reference level. If you do not specify the lower percent reference levels with the 'PercentReferenceLevels' name-value pair, the lower percent reference level is 10%.

UT

Time instants when signal crosses the upper-percent reference level. If you do not specify the upper-percent reference levels with the 'PercentReferenceLevels' name-value pair, the upper-percent reference level is 90%.

LL

Waveform values at the lower-reference level.

UL

Waveform values at the upper-reference level.

Examples

Slew Rate For One-Transition Waveform

Use `slewrates` with no output arguments to plot the slew rate information for a step waveform sampled at 4 MHz.

Load the `transitionex.mat` file and compute the slew rate. Annotate the slew rate in a plot of the waveform.

```
load('transitionex.mat','x','t')
```



```
slewrates(x,t)
```

```
ans = 1.0310e+07
```

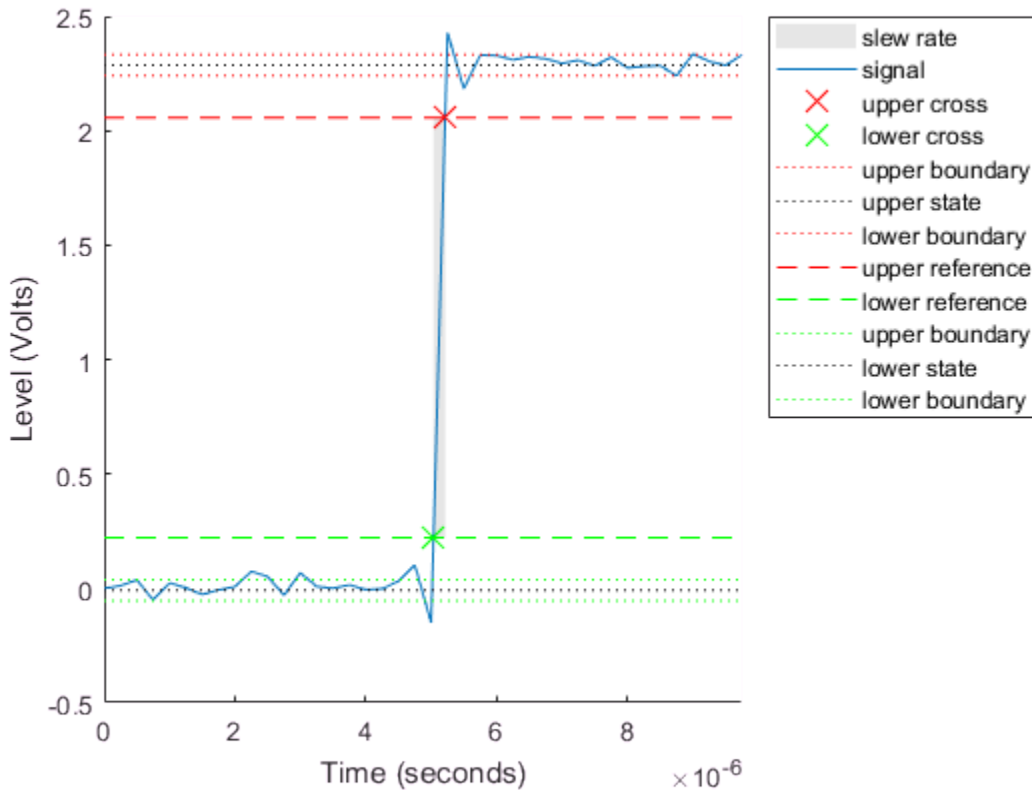

Slew Rates for Three-Transition Waveform

Create a bilevel waveform with three transitions, two positive and one negative. The sample rate is 4 MHz. Obtain the slew rates for the three transitions.

```
load('transitionex.mat','x')
fs = 4e6;
```

```
y = [x;fliplr(x)];
t = (0:length(y)-1)/4e6;
```

```
S = slewrate(y,t)
```

```
S =
```

```
1.0e+07 *  
1.0310  
-0.9320  
1.0310
```

Annotate the result on a plot of the waveform.

```
slewrate(y,t);
```

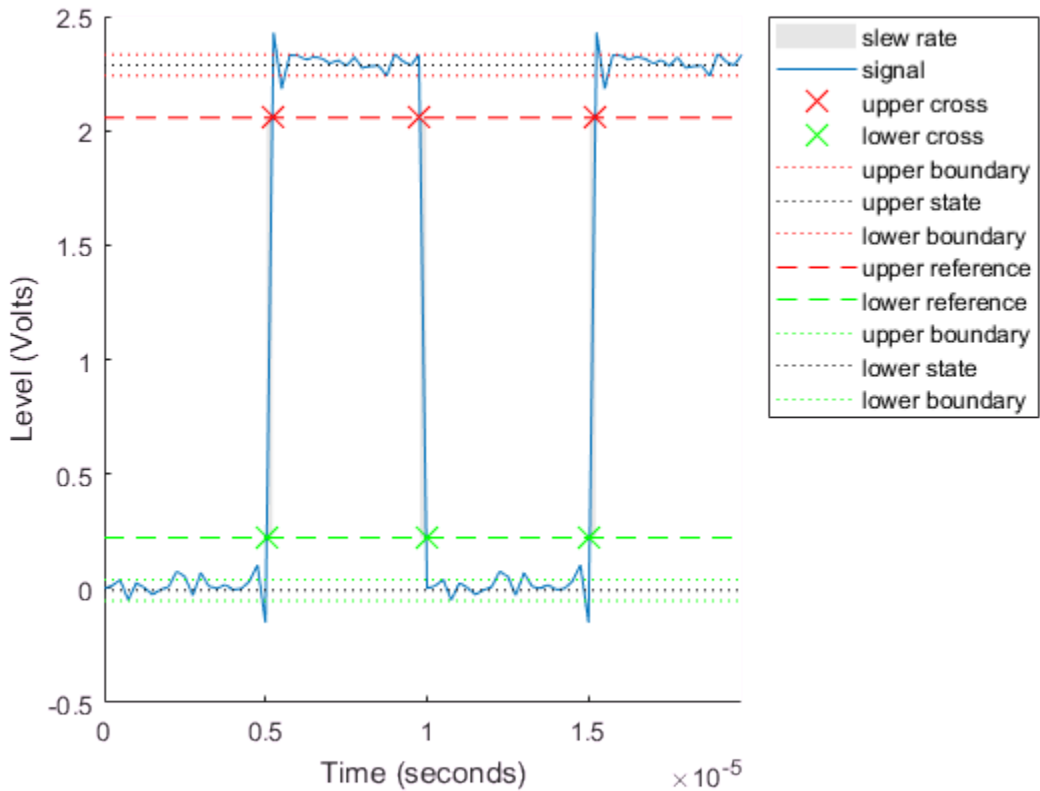

Lower and Upper Transition Times

Return the lower- and upper-transition times for a three-transition waveform sampled at 4 MHz.

```
load('transitionex.mat','x')
fs = 4e6;
```

```
y = [x;fliplr(x)];
t = (0:length(y)-1)/fs;
```

```
[~,LT,UT] = slewrates(y,t)
```

```
LT =
```

```
1.0e-04 *
    0.0504
    0.0998
    0.1504
```

```
UT =
```

```
1.0e-04 *
    0.0521
    0.0978
    0.1521
```

Repeat using the sample rate instead of the time vector.

```
[~,LT,UT] = slewrates(y,fs)
```

```
LT =
```

```
1.0e-04 *
    0.0504
    0.0998
    0.1504
```

```

UT =
    1.0e-04 *
    0.0521
    0.0978
    0.1521
    
```

Annotate the result on a plot of the waveform.

```
slewwrate(y,fs);
```

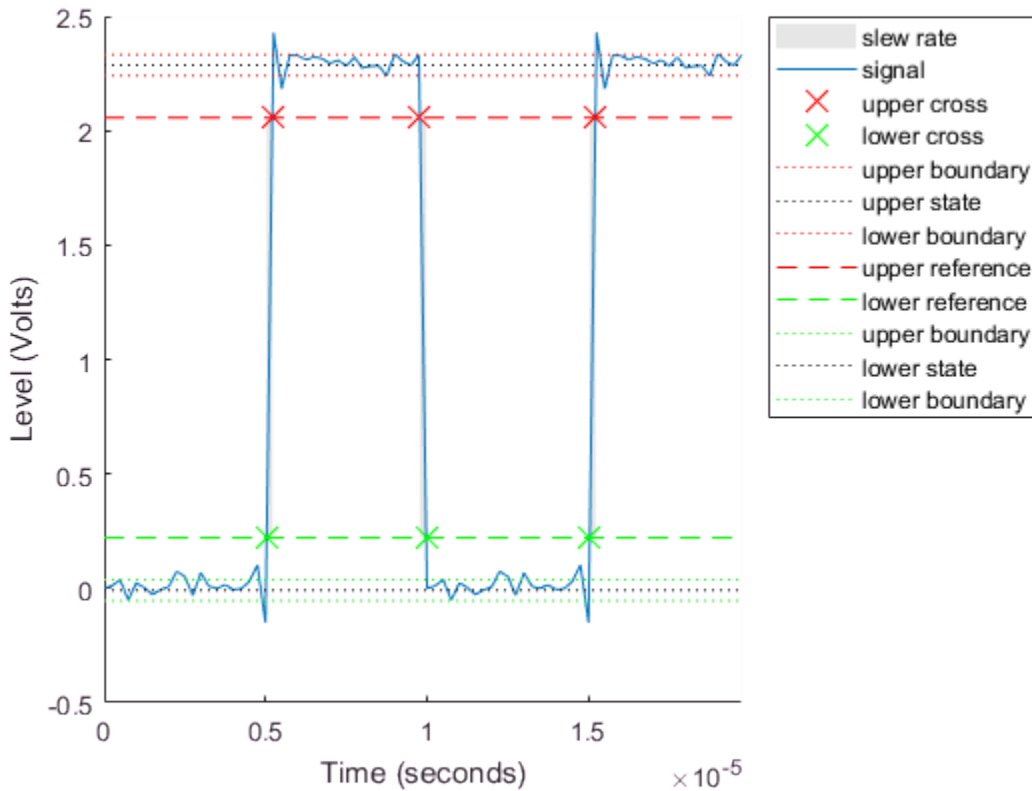

Lower and Upper Reference Levels

Return the waveform values corresponding to the lower- and upper-reference levels for a three-transition waveform sampled at 4 MHz. Compute these values for 10% and 90%, the default levels.

```
load('transitionex.mat','x')
fs = 4e6;

y = [x;flip1r(x)];
t = (0:length(y)-1)/fs;

[~,~,~,LL,UL] = slewrates(y,t)

LL = 0.2212
UL = 2.0564
```

Repeat the calculation for 20% and 80%. Annotate the result on a plot of the waveform

```
slewrates(y,t,'PercentReferenceLevels',[20 80]);
```

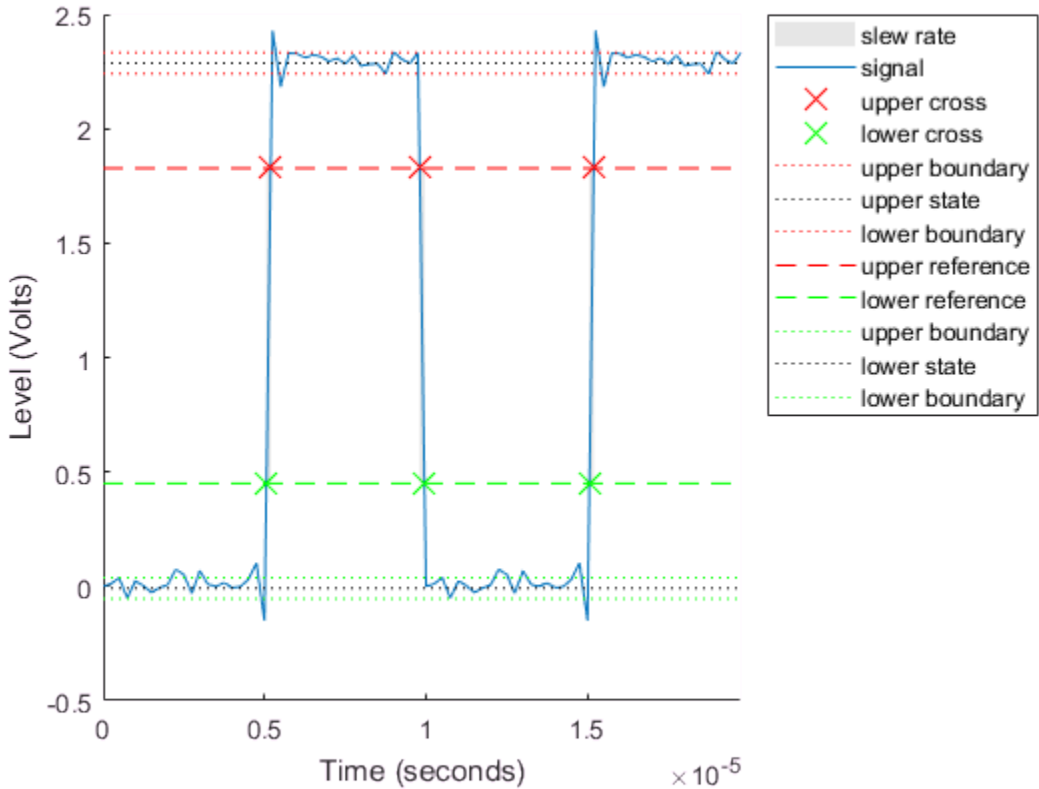

Definitions

Percent Reference Levels

If S_1 is the low state, S_2 is the high state, and U is the *upper*-percent reference level. The waveform value corresponding to the upper-percent reference level is

$$S_1 + \frac{U}{100}(S_2 - S_1).$$

If L is the *lower*-percent reference level, the waveform value corresponding to the lower percent reference level is

$$S_1 + \frac{L}{100}(S_2 - S_1).$$

Slew Rate

The slew rate is the slope of a line connecting the upper- and lower-percent reference levels. Let t_L denote the time instant when the waveform crosses the lower reference level and t_U denote the time instant when the waveform crosses the upper percent reference level. Using the definitions for the upper and lower percent reference levels given in “Percent Reference Levels” on page 1-2144, the slew rate is

$$\frac{S_1 + \frac{U}{100}(S_2 - S_1) - \{S_1 + \frac{L}{100}(S_2 - S_1)\}}{t_U - t_L} = \frac{U - L}{100} \frac{S_2 - S_1}{t_U - t_L}.$$

When t_L occurs earlier than t_U , the slew rate is positive. When t_U occurs earlier than t_L , the slew rate is negative.

State-Level Tolerances

Each state level can have associated lower- and upper-state boundaries. These state boundaries are defined as the state level plus or minus a scalar multiple of the difference between the high state and the low state. To provide a useful tolerance region, the scalar is typically a small number such as 2/100 or 3/100. In general, the $\alpha\%$ region for the low state is defined as

$$S_1 \pm \frac{\alpha}{100}(S_2 - S_1),$$

where S_1 is the low-state level and S_2 is the high-state level. Replace the first term in the equation with S_2 to obtain the $\alpha\%$ tolerance region for the high state.

The following figure illustrates lower and upper 2% state boundaries (tolerance regions) for a positive-polarity bilevel waveform. The red dashed lines indicate the estimated state levels.

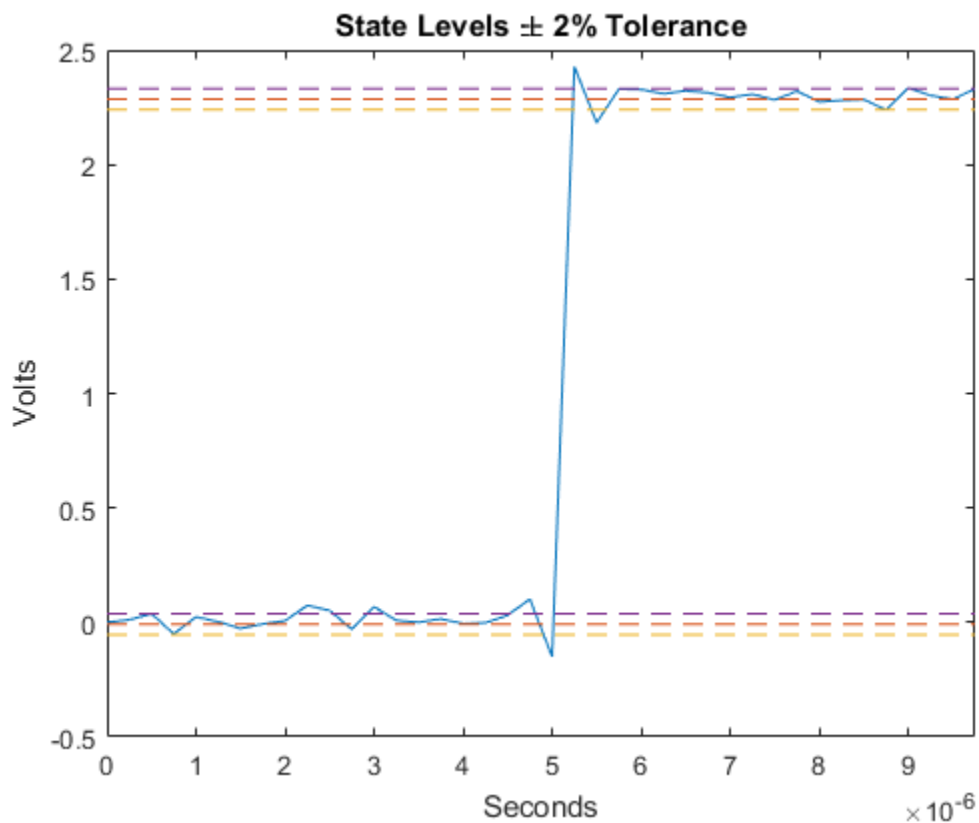

References

- [1] *IEEE Standard on Transitions, Pulses, and Related Waveforms*, IEEE Standard 181, 2003.

See Also

See Also

`falltime` | `midcross` | `pulsewidth` | `risetime` | `settlingtime` | `statelevels`

Introduced in R2012a

snr

Signal-to-noise ratio

Syntax

```
r = snr(x,y)
```

```
r = snr(x)
```

```
r = snr(x,fs,n)
```

```
r = snr(pxx,f,'psd')
```

```
r = snr(pxx,f,n,'psd')
```

```
r = snr(sxx,f,rbw,'power')
```

```
r = snr(sxx,f,rbw,n,'power')
```

```
r = snr( ____, 'aliased')
```

```
[r,noisepow] = snr( ____)
```

```
snr( ____)
```

Description

`r = snr(x,y)` returns the signal-to-noise ratio (SNR) in decibels of a signal, `x`, by computing the ratio of its summed squared magnitude to that of the noise, `y`. `y` must have the same dimensions as `x`. Use this form when the input signal is not necessarily sinusoidal and you have an estimate of the noise.

`r = snr(x)` returns the SNR in decibels relative to the carrier (dBc) of a real-valued sinusoidal input signal, `x`. The SNR is determined using a modified periodogram of the same length as the input. The modified periodogram uses a Kaiser window with $\beta = 38$. The result excludes the power of the first six harmonics, including the fundamental.

`r = snr(x,fs,n)` returns the SNR in dBc of a real sinusoidal input signal, `x`, sampled at a rate `fs`. The computation excludes the power contained in the lowest `n` harmonics, including the fundamental. The default value of `fs` is 1. The default value of `n` is 6.

`r = snr(pxx, f, 'psd')` specifies the input `pxx` as a one-sided power spectral density (PSD) estimate. The argument `f` is a vector of the frequencies at which the estimates of `pxx` occur. The computation of noise excludes the power of the first six harmonics, including the fundamental.

`r = snr(pxx, f, n, 'psd')` specifies the number of harmonics, `n`, to exclude when computing the SNR. The default value of `n` is 6 and includes the fundamental.

`r = snr(sxx, f, rbw, 'power')` specifies the input as a one-sided power spectrum, `sxx`, of a real signal. The input `rbw` is the resolution bandwidth over which each power estimate is integrated.

`r = snr(sxx, f, rbw, n, 'power')` specifies the number of harmonics, `n`, to exclude when computing the SNR. The default value of `n` is 6 and includes the fundamental.

`r = snr(____, 'aliased')` removes harmonics of the fundamental that are aliased into the Nyquist range. Use this option when the input signal is undersampled. If you do not specify this option, or if you set it to `'omitaliases'`, then the function treats as noise any harmonics of the fundamental frequency that lie beyond the Nyquist range.

`[r, noisepow] = snr(____)` also returns the total noise power of the nonharmonic components of the signal.

`snr(____)` with no output arguments plots the spectrum of the signal in the current figure window and labels its main features. It uses different colors to draw the fundamental component, the DC value and the harmonics, and the noise. The SNR appears above the plot. This functionality works for all syntaxes listed above except `snr(x, y)`.

Examples

Signal-to-Noise Ratio for Rectangular Pulse with Gaussian Noise

Compute the signal-to-noise ratio (SNR) of a 20 ms rectangular pulse sampled for 2 s at 10 kHz in the presence of Gaussian noise. Set the random number generator to the default settings for reproducible results.

```
rng default
Tpulse = 20e-3;
```

```
Fs = 10e3;
t = -1:1/Fs:1;
x = rectpuls(t,Tpulse);
y = 0.00001*randn(size(x));
s = x + y;
pulseSNR = snr(x,s-x)

pulseSNR = 80.0818
```

Compare SNR with THD and SINAD

Compute and compare the signal-to-noise ratio (SNR), the total harmonic distortion (THD), and the signal to noise and distortion ratio (SINAD) of a signal.

Create a sinusoidal signal sampled at 48 kHz. The signal has a fundamental of frequency 1 kHz and unit amplitude. It additionally contains a 2 kHz harmonic with half the amplitude and additive noise with variance 0.1².

```
fs = 48e3;
t = 0:1/fs:1-1/fs;
A = 1.0;
powfund = A^2/2;
a = 0.4;
powharm = a^2/2;
s = 0.1;
varnoise = s^2;
x = A*cos(2*pi*1000*t) + ...
    a*sin(2*pi*2000*t) + s*randn(size(t));
```

Verify that SNR, THD, and SINAD agree with their definitions.

```
SNR = snr(x);
defSNR = 10*log10(powfund/varnoise);
SN = [SNR defSNR]
```

```
SN =
```

```
17.0178 16.9897
```

```
THD = thd(x);
defTHD = 10*log10(powharm/powfund);
```

```
TH = [THD defTHD]
```

```
TH =
```

```
    -7.9546    -7.9588
```

```
SINAD = sinad(x);  
defSINAD = 10*log10(powfund/(powharm+varnoise));  
SI = [SINAD defSINAD]
```

```
SI =
```

```
    7.4571    7.4473
```

Signal-to-Noise Ratio of Sinusoid

Compute the SNR of a 2.5 kHz sinusoid sampled at 48 kHz. Add white noise with variance 0.001^2 .

```
Fi = 2500;  
Fs = 48e3;  
N = 1024;  
x = sin(2*pi*Fi/Fs*(1:N)) + 0.001*randn(1,N);  
SNR = snr(x,Fs)
```

```
SNR = 57.7103
```

Plot the spectrum and annotate the SNR.

```
snr(x,Fs);
```

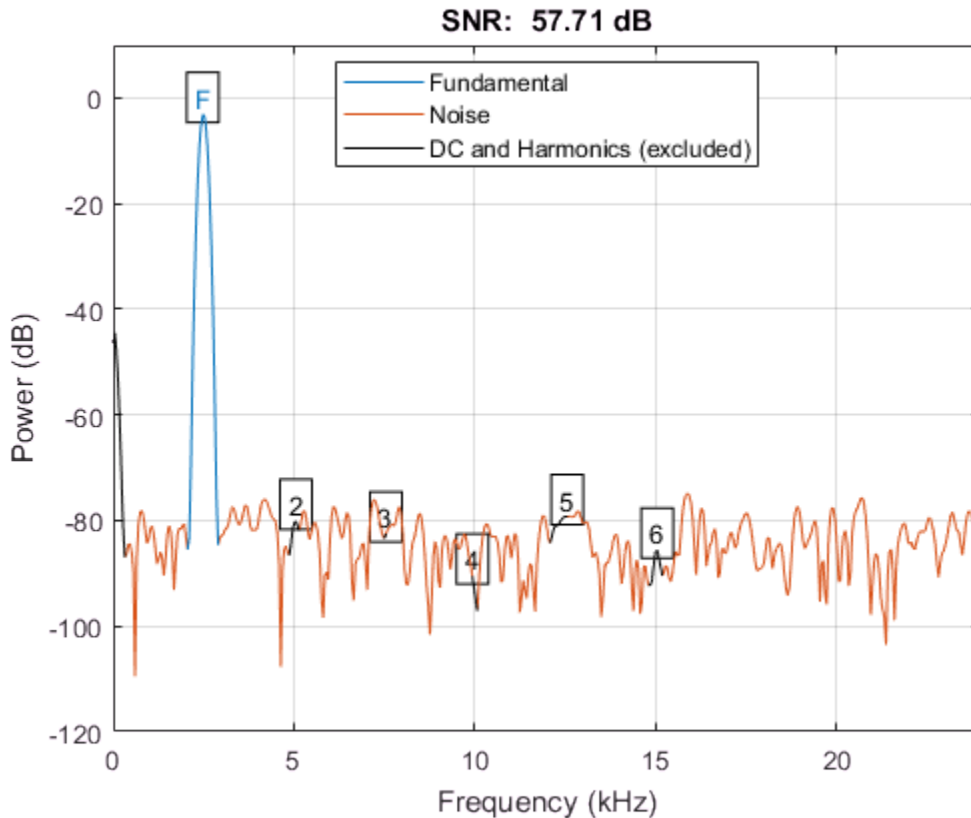

SNR of Sinusoid Using PSD

Obtain the periodogram power spectral density (PSD) estimate of a 2.5 kHz sinusoid sampled at 48 kHz. Add white noise with standard deviation 0.00001. Use this value as input to determine the SNR. Set the random number generator to the default settings for reproducible results.

```
rng default
Fi = 2500;
Fs = 48e3;
N = 1024;
x = sin(2*pi*Fi/Fs*(1:N)) + 0.00001*randn(1,N);
```

```
w = kaiser(numel(x),38);  
[Pxx, F] = periodogram(x,w,numel(x),Fs);  
SNR = snr(Pxx,F,'psd')
```

```
SNR = 97.7446
```

SNR of Sinusoid Using Power Spectrum

Using the power spectrum, compute the SNR of a 2.5 kHz sinusoid sampled at 48 kHz and embedded in white noise with a standard deviation of 0.00001. Reset the random number generator for reproducible results.

```
rng default  
Fi = 2500;  
Fs = 48e3;  
N = 1024;  
x = sin(2*pi*Fi/Fs*(1:N)) + 0.00001*randn(1,N);  
  
w = kaiser(numel(x),38);  
[Sxx, F] = periodogram(x,w,numel(x),Fs,'power');  
rbw = enbw(w,Fs);  
SNR = snr(Sxx,F,rbw,'power')
```

```
SNR = 97.7446
```

Plot the spectrum of the signal and annotate the SNR.

```
snr(Sxx,F,rbw,'power');
```

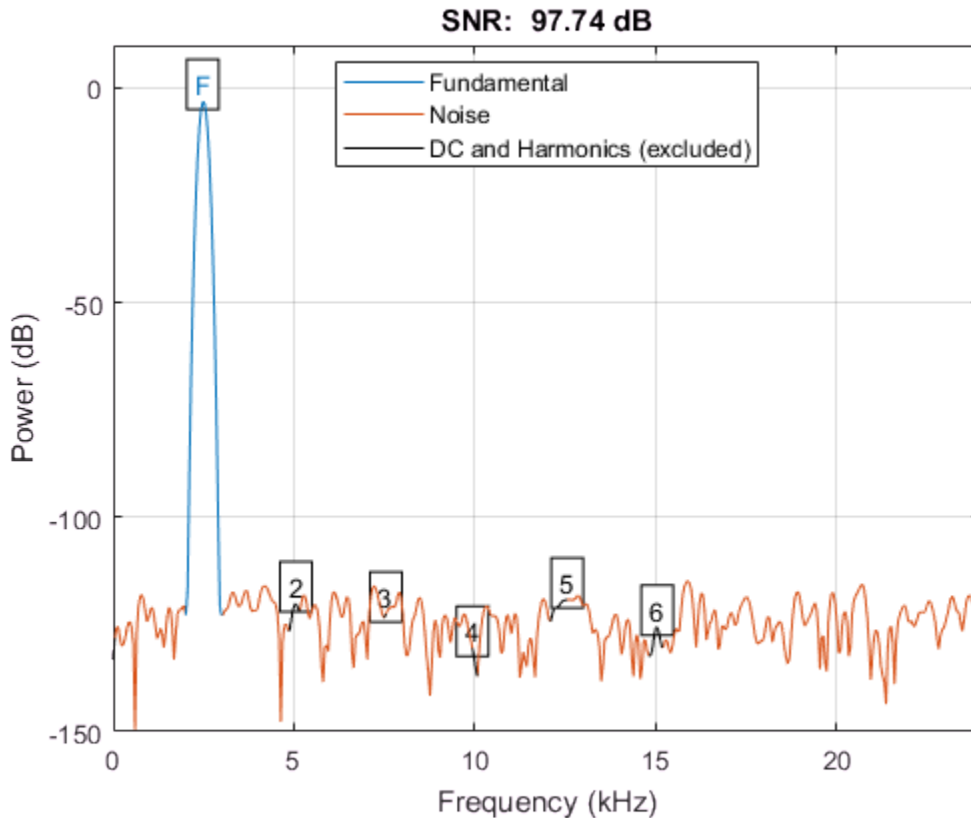

SNR with and Without Aliased Harmonics

Generate a signal that resembles the output of a weakly nonlinear amplifier with a 2.1 kHz tone as input. The signal is sampled for 1 second at 10 kHz. Compute and plot the power spectrum of the signal. Use a Kaiser window with $\beta = 38$ for the computation.

```
Fs = 10000;
f = 2100;
```

```
t = 0:1/Fs:1;
x = tanh(sin(2*pi*f*t)+0.1) + 0.001*randn(1,length(t));
```

```
periodogram(x,kaiser(length(x),38),[],Fs,'power')
```

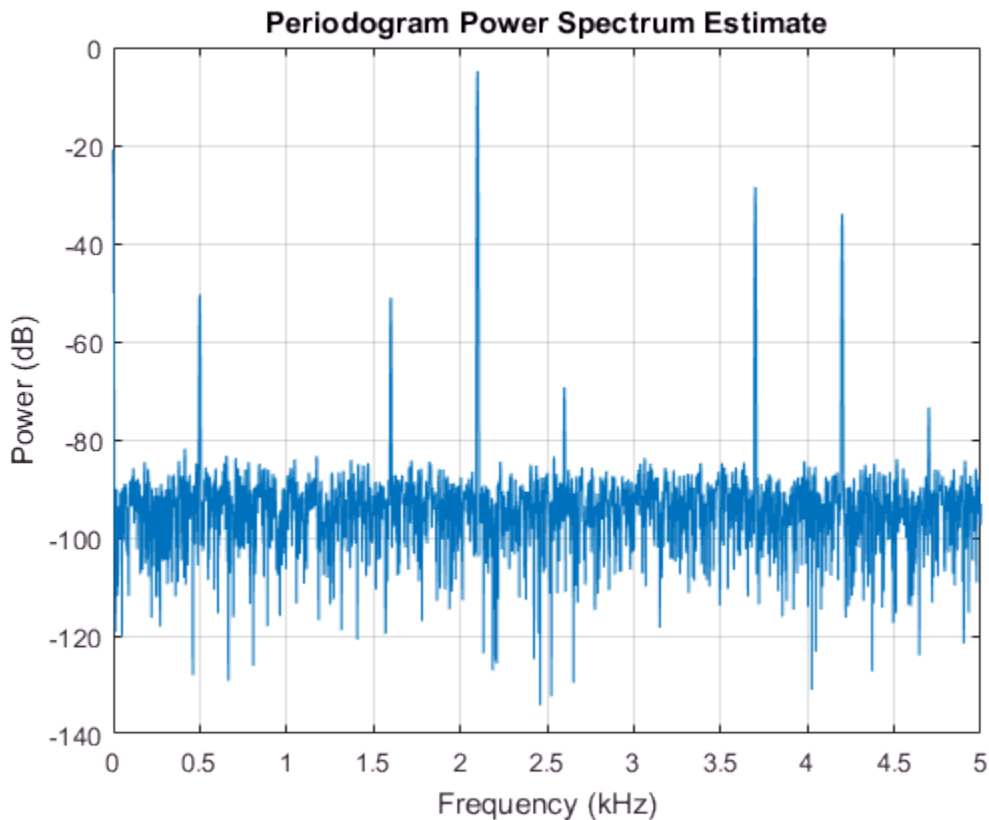
Harmonics stick out from the noise at frequencies of 4.2 kHz, 6.3 kHz, 8.4 kHz, 10.5 kHz, 12.6 kHz, and 14.7 kHz. All frequencies except for the first one are greater than the Nyquist frequency. The harmonics are aliased respectively into 3.7 kHz, 1.6 kHz, 0.5 kHz, 2.6 kHz, and 4.7 kHz.

Compute the signal-to-noise ratio of the signal. By default, `snr` treats the aliased harmonics as part of the noise.

```
snr(x,Fs,7);
```

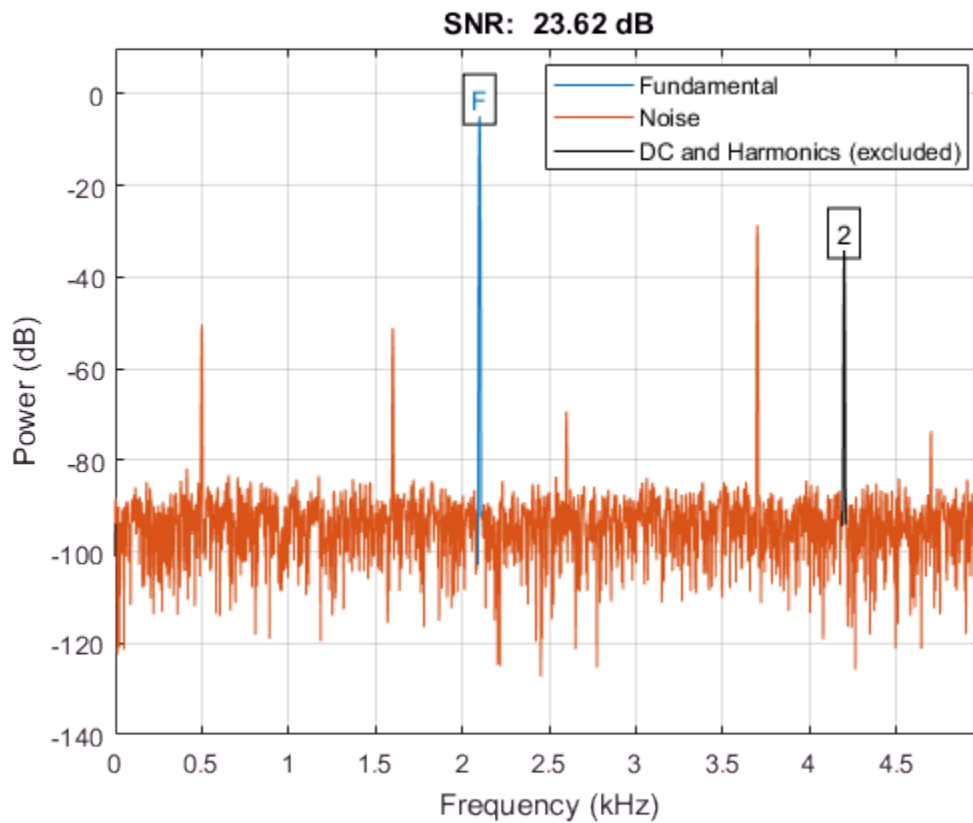

Repeat the computation, but now treat the aliased harmonics as part of the signal.

```
snr(x,Fs,7,'aliased');
```

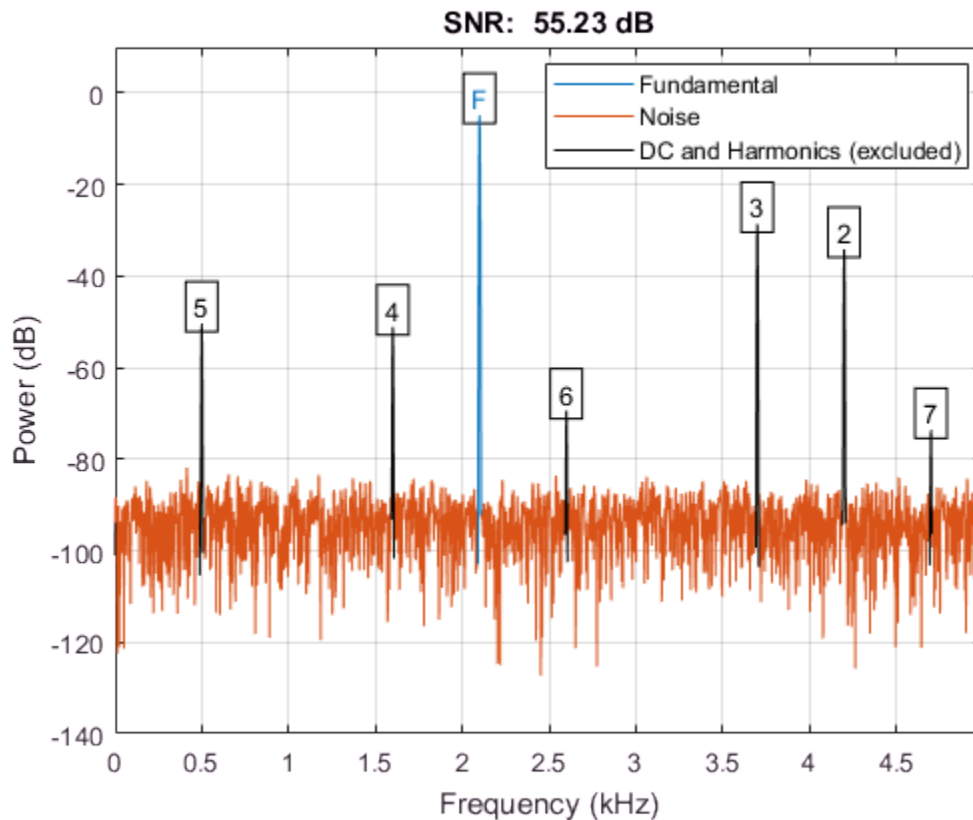

Noise Power

Create a sinusoidal signal sampled at 48 kHz. The signal has a fundamental of frequency 1 kHz and unit amplitude. It additionally contains a 2 kHz harmonic with half the amplitude and additive noise with variance 0.1^2 .

```
fs = 48e3;
t = 0:1/fs:1-1/fs;
```

```
A = 1.0;
powfund = A^2/2;
a = 0.4;
```

```
powharm = a^2/2;
s = 0.1;
varnoise = s^2;

x = A*cos(2*pi*1000*t) + ...
    a*sin(2*pi*2000*t) + s*randn(size(t));
```

Compute the noise power in the signal. Verify that it agrees with the definition.

```
[SNR,npow] = snr(x,fs);
compare = [10*log10(powfund)-npow SNR]

compare =

    17.0281    17.0178
```

SNR of Amplified Signal

Generate a sinusoid of frequency 2.5 kHz sampled at 50 kHz. Reset the random number generator. Add Gaussian white noise with standard deviation 0.00005 to the signal. Pass the result through a weakly nonlinear amplifier. Plot the SNR.

```
rng default

fs = 5e4;
f0 = 2.5e3;
N = 1024;
t = (0:N-1)/fs;

ct = cos(2*pi*f0*t);
cd = ct + 0.00005*randn(size(ct));

amp = [1e-5 5e-6 -1e-3 6e-5 1 25e-3];
sgn = polyval(amp,cd);

snr(sgn,fs);
```

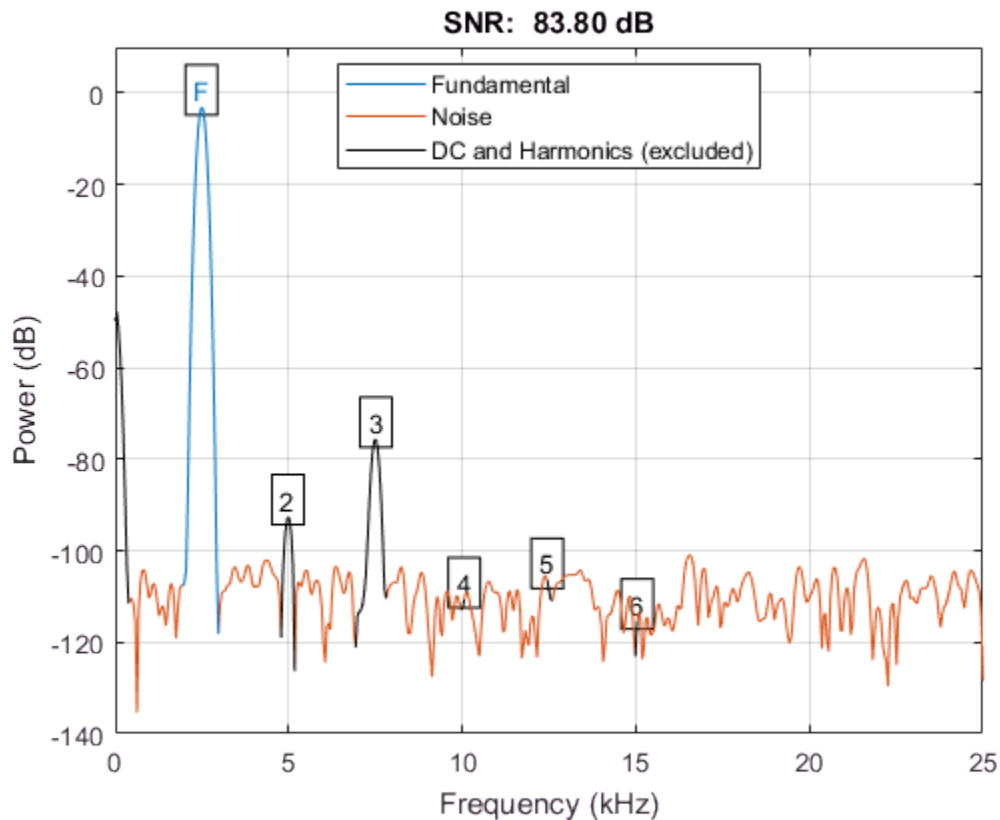

The DC component and all harmonics, including the fundamental, are excluded from the noise measurement. The fundamental and harmonics are labeled.

- “Analyzing Harmonic Distortion”

Input Arguments

x — Real-valued input signal

real vector

Real-valued input signal, specified as a row or column vector.

Data Types: `double` | `single`

y — **Noise estimate**

real vector

Estimate of the noise in the input signal, specified as a real-valued row or column vector. It must have the same dimensions as **x**.

Data Types: `double` | `single`

fs — **Sample rate**

1 (default) | positive real scalar

Sample rate, specified as a positive scalar. The sample rate is the number of samples per unit time. If the unit of time is seconds, then the sample rate has units of hertz.

Data Types: `double` | `single`

n — **Number of harmonics**

6 (default) | positive integer scalar

Number of harmonics to exclude from the SNR computation, specified as a positive integer scalar. The default value of **n** is 6.

pxx — **One-sided PSD estimate**

vector

One-sided power spectral density estimate, specified as a real-valued, nonnegative column vector.

Data Types: `double` | `single`

f — **Cyclical frequencies**

real-valued row or column vector

Cyclical frequencies of the one-sided PSD estimate, **pxx**, specified as a row or column vector. The first element of **f** must be 0.

Data Types: `double` | `single`

sxx — **Power spectrum**

nonnegative real-valued row or column vector

Power spectrum, specified as a real-valued nonnegative row or column vector.

Data Types: `double` | `single`

rbw — Resolution bandwidth

positive scalar

Resolution bandwidth, specified as a positive scalar. The resolution bandwidth is the product of the frequency resolution of the discrete Fourier transform and the equivalent noise bandwidth of the window.

Data Types: `double` | `single`

Output Arguments

r — Signal-to-noise ratio

real-valued scalar

Signal-to-noise ratio, expressed in decibels relative to the carrier (dBc), returned as a real-valued scalar. The SNR is returned in decibels (dB) if the input signal is not sinusoidal.

Data Types: `double` | `single`

noisepow — Total noise power

real-valued scalar

Total noise power of the nonharmonic components of the input signal, returned as a real-valued scalar.

Data Types: `double` | `single`

Definitions

Distortion Measurement Functions

The functions `thd`, `sfdr`, `sinad`, and `snr` measure the response of a weakly nonlinear system stimulated by a sinusoid.

When given time-domain input, `snr` performs a periodogram using a Kaiser window with large sidelobe attenuation. To find the fundamental frequency, the algorithm searches

the periodogram for the largest nonzero spectral component. It then computes the central moment of all adjacent bins that decrease monotonically away from the maximum. To be detectable, the fundamental should be at least in the second frequency bin. Higher harmonics are at integer multiples of the fundamental frequency. If a harmonic lies within the monotonically decreasing region in the neighborhood of another, its power is considered to belong to the larger harmonic. This larger harmonic may or may not be the fundamental.

The function estimates a noise level using the median power in the regions containing only noise. The DC component is excluded from the calculation. The noise at each point is the estimated level or the ordinate of the point, whichever is smaller. The noise is then subtracted from the values of the signal and the harmonics.

snr fails if the fundamental is not the highest spectral component in the signal.

Ensure that the frequency components are far enough apart to accommodate for the sidelobe width of the Kaiser window. If this is not feasible, you can use the 'power' flag and compute a periodogram with a different window.

See Also

See Also

sfdr | sinad | thd | toi

Topics

“Analyzing Harmonic Distortion”

Introduced in R2013b

sos2cell

Convert second-order sections matrix to cell array

Syntax

```
c = sos2cell(m)
c = sos2cell(m,g)
```

Description

`c = sos2cell(m)` changes an L -by-6 second-order section matrix m generated by `tf2sos` into a 1-by- L cell array of 1-by-2 cell arrays, c . You can use c to specify a quantized filter with L cascaded second-order sections.

The matrix m should have the form

$$m = [b_1 \ a_1; b_2 \ a_2; \dots; b_L \ a_L]$$

where both b_i and a_i , with $i = 1, \dots, L$, are 1-by-3 row vectors. The resulting c is a 1-by- L cell array of cells of the form

$$c = \{ \{b_1 \ a_1\} \{b_2 \ a_2\} \dots \{b_L \ a_L\} \}$$

`c = sos2cell(m,g)` with the optional gain term g , prepends the constant value g to c . When you use the added gain term in the command, c is a 1-by- L cell array of cells of the form

$$c = \{ \{g, 1\} \{b_1, a_1\} \{b_2, a_2\} \dots \{b_L, a_L\} \}$$

Examples

Second-Order-Section Cell Array of Elliptic Filter

Generate a lowpass elliptic filter of order 4 with 0.5 dB of passband ripple and 20 dB of stopband attenuation. The passband edge is 0.6 times the Nyquist frequency. Convert the transfer function to a matrix of second-order sections.

```
[b,a] = ellip(4,0.5,20,0.6);  
m = tf2sos(b,a);
```

Use `sos2cell` to convert the 2-by-6 matrix produced by `tf2sos` into a 1-by-2 cell array, `c`, of cells. Display the second entry in the first cell of `c`. Verify that it contains the denominator coefficients of the first second-order section of `m`.

```
c = sos2cell(m);  
compare = [c{1}{2};m(1,4:6)]  
  
compare =  
  
    1.0000    0.1677    0.2575  
    1.0000    0.1677    0.2575
```

See Also

`tf2sos` | `cell2sos`

Introduced before R2006a

sos2ss

Convert digital filter second-order section parameters to state-space form

Syntax

```
[A,B,C,D] = sos2ss(sos)
[A,B,C,D] = sos2ss(sos,g)
```

Description

sos2ss converts a second-order section representation of a digital filter to an equivalent state-space representation.

[A,B,C,D] = sos2ss(sos) converts **sos**, a system expressed in second-order section form, to a single-input, single-output state-space representation:

$$\begin{aligned}x(n+1) &= Ax(n) + Bu(n), \\y(n) &= Cx(n) + Du(n).\end{aligned}$$

The discrete transfer function in second-order section form is given by

$$H(z) = \prod_{k=1}^L H_k(z) = \prod_{k=1}^L \frac{b_{0k} + b_{1k}z^{-1} + b_{2k}z^{-2}}{1 + a_{1k}z^{-1} + a_{2k}z^{-2}}.$$

sos is a $L \times 6$ matrix organized as

$$\text{sos} = \begin{bmatrix} b_{01} & b_{11} & b_{21} & 1 & a_{11} & a_{21} \\ b_{02} & b_{12} & b_{22} & 1 & a_{12} & a_{22} \\ \vdots & \vdots & \vdots & \vdots & \vdots & \vdots \\ b_{0L} & b_{1L} & b_{2L} & 1 & a_{1L} & a_{2L} \end{bmatrix}.$$

The entries of **sos** must be real for proper conversion to state space. The returned matrix **A** is of size $2L \times 2L$, **B** is a $2L \times 1$ column vector, **C** is a $1 \times 2L$ row vector, and **D** is a 1×1 scalar.

[A,B,C,D] = sos2ss(sos,g) converts to state space a system SOS in second-order section form with gain g:

$$H(z) = g \prod_{k=1}^L H_k(z).$$

Examples

State-Space Representation of a Second-Order Section System

Compute the state-space representation of a simple second-order section system with a gain of 2.

```
sos = [1  1  1  1  0  -1 ;
       -2  3  1  1  10  1];
[A,B,C,D] = sos2ss(sos,2)
```

A =

```
-10    0    10    1
  1     0     0     0
  0     1     0     0
  0     0     1     0
```

B =

```
1
0
0
0
```

C =

```
42    4   -32   -2
```

D = -4

Algorithms

sos2ss first converts from second-order sections to transfer function using `sos2tf`, and then from transfer function to state-space using `tf2ss`.

See Also

`sos2tf` | `sos2zp` | `ss2sos` | `tf2ss` | `zp2ss`

Introduced before R2006a

sos2tf

Convert digital filter second-order section data to transfer function form

Syntax

```
[b,a] = sos2tf(sos)
[b,a] = sos2tf(sos,g)
```

Description

sos2tf converts a second-order section representation of a given digital filter to an equivalent transfer function representation.

[b,a] = sos2tf(sos) returns the numerator coefficients **b** and denominator coefficients **a** of the transfer function that describes a discrete-time system given by **sos** in second-order section form. The second-order section format of $H(z)$ is given by

$$H(z) = \prod_{k=1}^L H_k(z) = \prod_{k=1}^L \frac{b_{0k} + b_{1k}z^{-1} + b_{2k}z^{-2}}{1 + a_{1k}z^{-1} + a_{2k}z^{-2}}.$$

sos is an L -by-6 matrix that contains the coefficients of each second-order section stored in its rows.

$$\text{sos} = \begin{bmatrix} b_{01} & b_{11} & b_{21} & 1 & a_{11} & a_{21} \\ b_{02} & b_{12} & b_{22} & 1 & a_{12} & a_{22} \\ \vdots & \vdots & \vdots & \vdots & \vdots & \vdots \\ b_{0L} & b_{1L} & b_{2L} & 1 & a_{1L} & a_{2L} \end{bmatrix}.$$

Row vectors **b** and **a** contain the numerator and denominator coefficients of $H(z)$ stored in descending powers of z .

$$H(z) = \frac{B(z)}{A(z)} = \frac{b_1 + b_2z^{-1} + \cdots + b_{n+1}z^{-n}}{a_1 + a_2z^{-1} + \cdots + a_{m+1}z^{-m}}$$

`[b,a] = sos2tf(sos,g)` returns the transfer function that describes a discrete-time system given by `sos` in second-order section form with gain `g`.

$$H(z) = g \prod_{k=1}^L H_k(z).$$

Examples

Transfer Function Representation of a Second-Order Section System

Compute the transfer function representation of a simple second-order section system.

```
sos = [1  1  1  1  0 -1; -2  3  1  1 10  1];
[b,a] = sos2tf(sos)
```

b =

```
    -2     1     2     4     1
```

a =

```
     1    10     0   -10    -1
```

Algorithms

`sos2tf` uses the `conv` function to multiply all of the numerator and denominator second-order polynomials together. For higher order filters (possibly starting as low as order 8), numerical problems due to roundoff errors may occur when forming the transfer function.

See Also

`latc2tf` | `sos2ss` | `sos2zp` | `ss2tf` | `tf2sos` | `zp2tf`

Introduced before R2006a

sos2zp

Convert digital filter second-order section parameters to zero-pole-gain form

Syntax

```
[z,p,k] = sos2zp(sos)
[z,p,k] = sos2zp(sos,g)
```

Description

sos2zp converts a second-order section representation of a given digital filter to an equivalent zero-pole-gain representation.

[z,p,k] = sos2zp(sos) returns the zeros z, poles p, and gain k of the system given by sos in second-order section form. The second-order section format of $H(z)$ is given by

$$H(z) = \prod_{k=1}^L H_k(z) = \prod_{k=1}^L \frac{b_{0k} + b_{1k}z^{-1} + b_{2k}z^{-2}}{1 + a_{1k}z^{-1} + a_{2k}z^{-2}}.$$

sos is an L -by-6 matrix that contains the coefficients of each second-order section in its rows.

$$\text{sos} = \begin{bmatrix} b_{01} & b_{11} & b_{21} & 1 & a_{11} & a_{21} \\ b_{02} & b_{12} & b_{22} & 1 & a_{12} & a_{22} \\ \vdots & \vdots & \vdots & \vdots & \vdots & \vdots \\ b_{0L} & b_{1L} & b_{2L} & 1 & a_{1L} & a_{2L} \end{bmatrix}.$$

Column vectors z and p contain the zeros and poles of the transfer function $H(z)$.

$$H(z) = k \frac{(z - z_1)(z - z_2) \cdots (z - z_n)}{(p - p_1)(p - p_2) \cdots (p - p_m)}$$

where the orders n and m are determined by the matrix `sos`.

`[z,p,k] = sos2zp(sos,g)` returns the zeros `z`, poles `p`, and gain `k` of the system given by `sos` in second-order section form with gain `g`.

$$H(z) = g \prod_{k=1}^L H_k(z).$$

Examples

Zeros, Poles, and Gain of a System

Compute the zeros, poles, and gain of a simple system in second-order section form.

```
sos = [1 1 1 1 0 -1; -2 3 1 1 10 1];
[z,p,k] = sos2zp(sos)
```

```
z =
-0.5000 + 0.8660i
-0.5000 - 0.8660i
 1.7808 + 0.0000i
-0.2808 + 0.0000i
```

```
p =
-1.0000
 1.0000
-9.8990
-0.1010
```

```
k = -2
```

Algorithms

`sos2zp` finds the poles and zeros of each second-order section by repeatedly calling `tf2zp`.

See Also

sos2ss | sos2tf | ss2zp | tf2zp | tf2zpk | zp2sos

Introduced before R2006a

sosfilt

Second-order (biquadratic) IIR digital filtering

Syntax

```
y = sosfilt(sos,x)
y = sosfilt(sos,x,dim)
```

Description

`y = sosfilt(sos,x)` applies the second-order section digital filter `sos` to the vector `x`. The output, `y`, is the same length as `x`.

Note: If either input to `sosfilt` is single precision, filtering is implemented using single-precision arithmetic. The output, `y`, is single precision.

`sos` represents the second-order section digital filter $H(z)$

$$H(z) = \prod_{k=1}^L H_k(z) = \prod_{k=1}^L \frac{b_{0k} + b_{1k}z^{-1} + b_{2k}z^{-2}}{1 + a_{1k}z^{-1} + a_{2k}z^{-2}}$$

by an L -by-6 matrix containing the coefficients of each second-order section in its rows.

$$\text{sos} = \begin{bmatrix} b_{01} & b_{11} & b_{21} & 1 & a_{11} & a_{21} \\ b_{02} & b_{12} & b_{22} & 1 & a_{12} & a_{22} \\ \vdots & \vdots & \vdots & \vdots & \vdots & \vdots \\ b_{0L} & b_{1L} & b_{2L} & 1 & a_{1L} & a_{2L} \end{bmatrix}$$

If `x` is a matrix, `sosfilt` applies the filter to each column of `x` independently. The output `y` is a matrix of the same size, containing the filtered data corresponding to each column of `x`.

If x is a multidimensional array, `sosfilt` filters along the first nonsingleton dimension. The output y is a multidimensional array of the same size as x , containing the filtered data corresponding to each row and column of x .

The second order sections matrix, `sos`, the input signal, x , or both can be double or single precision. If at least one input is single precision, filtering is done with single precision arithmetic.

`y = sosfilt(sos,x,dim)` operates along the dimension `dim`.

Examples

Second-Order Section Filtering

Load `chirp.mat`. The file contains a signal, y , that has most of its power above $F_s/4$, or half the Nyquist frequency. The sample rate is 8192 Hz.

```
load chirp
```

```
t = (0:length(y)-1)/Fs;
```

Design a 7th-order Butterworth highpass filter to attenuate the components of the signal below $F_s/4$. Use a normalized cutoff frequency of 0.48π rad/sample. Express the filter coefficients in terms of second-order sections.

```
[zhi,phi,khi] = butter(7,0.48,'high');  
soshi = zp2sos(zhi,phi,khi);
```

```
freqz(soshi)
```

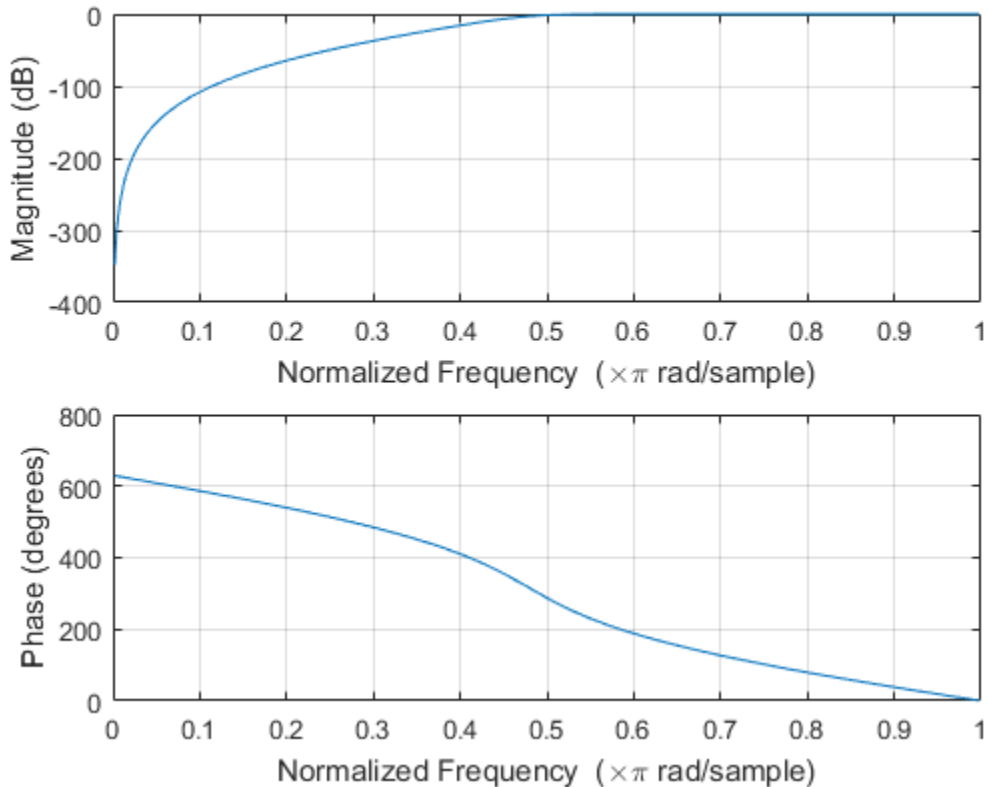

Filter the signal. Display the original and highpass-filtered signals. Use the same y-axis scale for both plots.

```
outhi = sosfilt(soshi,y);

subplot(2,1,1)
plot(t,y)
title('Original Signal')
ys = ylim;

subplot(2,1,2)
plot(t,outhi)
title('Highpass-Filtered Signal')
xlabel('Time (s)')
```

```
ylim(ys)
```

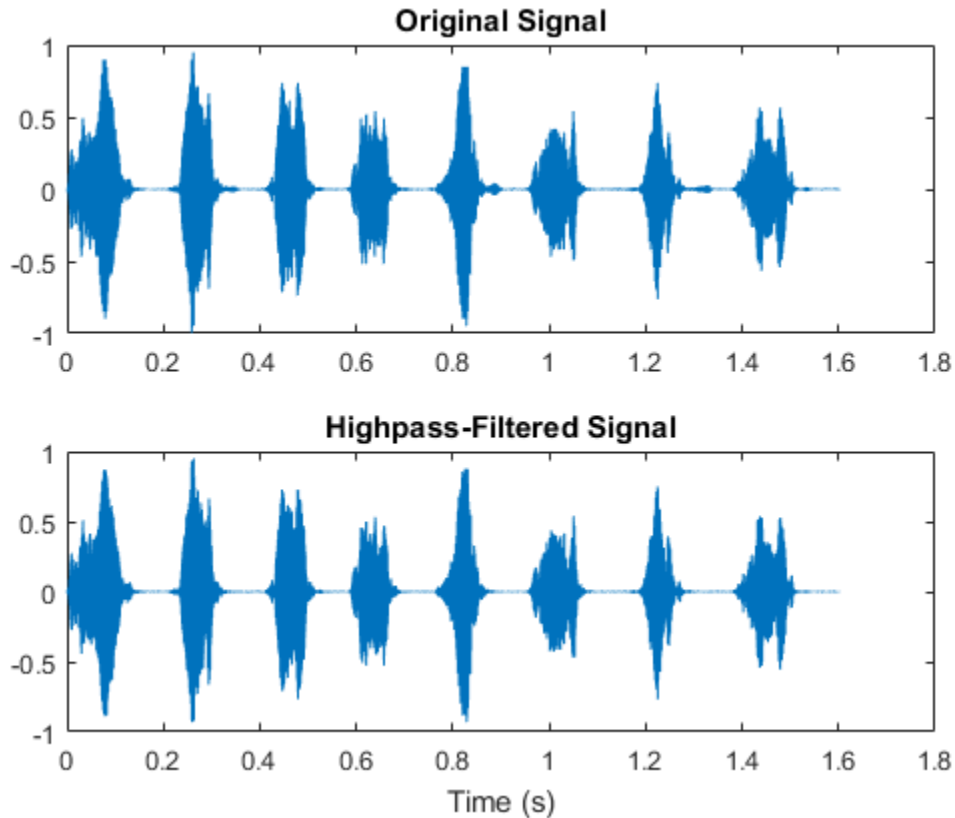

Design a lowpass filter with the same specifications. Filter the signal and compare the result to the original. Use the same y-axis scale for both plots. The result is mostly noise.

```
[zlo,plo,klo] = butter(7,0.48);
soslo = zp2sos(zlo,plo,klo);

outlo = sosfilt(soslo,y);

subplot(2,1,1)
plot(t,y)
title('Original Signal')
ys = ylim;
```

```
subplot(2,1,2)
plot(t,outlo)
title('Lowpass-Filtered Signal')
xlabel('Time (s)')
ylim(ys)
```

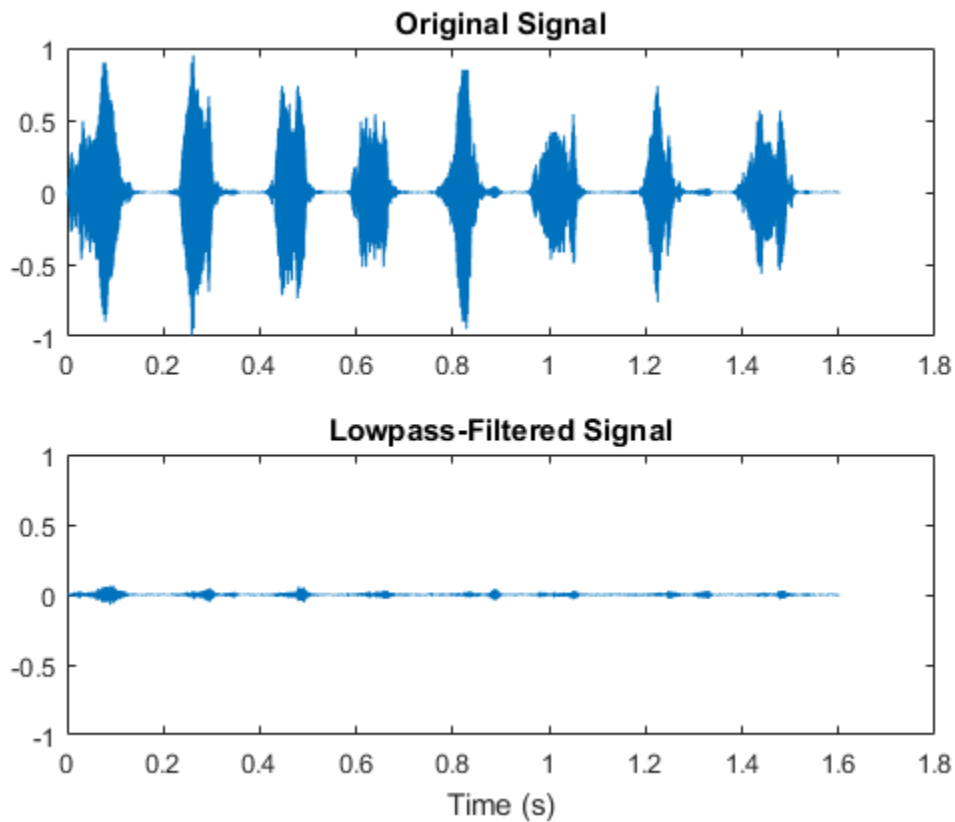

References

- [1] Orfanidis, S.J., *Introduction to Signal Processing*, Prentice-Hall, Englewood Cliffs, NJ, 1996.

Extended Capabilities

C/C++ Code Generation

Generate C and C++ code using MATLAB® Coder™.

See Also

`filter` | `medfilt1` | `sgolayfilt`

Introduced before R2006a

spectrogram

Spectrogram using short-time Fourier transform

Syntax

```
s = spectrogram(x)
s = spectrogram(x,window)
s = spectrogram(x,window,noverlap)
s = spectrogram(x,window,noverlap,nfft)

[s,w,t] = spectrogram( ___ )
[s,f,t] = spectrogram( ___ ,fs)

[s,w,t] = spectrogram(x,window,noverlap,w)
[s,f,t] = spectrogram(x,window,noverlap,f,fs)

[ ___ ,ps] = spectrogram( ___ )

[ ___ ] = spectrogram( ___ , 'reassigned')
[ ___ ,ps,fc,tc] = spectrogram( ___ )

[ ___ ] = spectrogram( ___ ,freqrange)
[ ___ ] = spectrogram( ___ ,spectrumtype)
[ ___ ] = spectrogram( ___ , 'MinThreshold', thresh)

spectrogram( ___ )
spectrogram( ___ ,freqloc)
```

Description

`s = spectrogram(x)` returns the short-time Fourier transform of the input signal, `x`. Each column of `s` contains an estimate of the short-term, time-localized frequency content of `x`.

`s = spectrogram(x,window)` uses `window` to divide the signal into segments and perform windowing.

`s = spectrogram(x,window,noverlap)` uses `noverlap` samples of overlap between adjoining segments.

`s = spectrogram(x,window,noverlap,nfft)` uses `nfft` sampling points to calculate the discrete Fourier transform.

`[s,w,t] = spectrogram(___)` returns a vector of normalized frequencies, `w`, and a vector of time instants, `t`, at which the spectrogram is computed. This syntax can include any combination of input arguments from previous syntaxes.

`[s,f,t] = spectrogram(___,fs)` returns a vector of cyclical frequencies, `f`, expressed in terms of the sample rate, `fs`. `fs` must be the fifth input to `spectrogram`. To input a sample rate and still use the default values of the preceding optional arguments, specify these arguments as empty, `[]`.

`[s,w,t] = spectrogram(x,window,noverlap,w)` returns the spectrogram at the normalized frequencies specified in `w`.

`[s,f,t] = spectrogram(x,window,noverlap,f,fs)` returns the spectrogram at the cyclical frequencies specified in `f`.

`[___,ps] = spectrogram(___)` also returns a matrix, `ps`, containing an estimate of the power spectral density (PSD) or the power spectrum of each segment.

`[___] = spectrogram(___, 'reassigned')` reassigns each PSD or power spectrum estimate to the location of its center of energy. If your signal contains well-localized temporal or spectral components, then this option generates a sharper spectrogram.

`[___,ps,fc,tc] = spectrogram(___)` also returns two matrices, `fc` and `tc`, containing the frequency and time of the center of energy of each PSD or power spectrum estimate.

`[___] = spectrogram(___,freqrange)` returns the PSD or power spectrum estimate over the frequency range specified by `freqrange`. Valid options for `freqrange` are `'onesided'`, `'twosided'`, and `'centered'`.

`[___] = spectrogram(___,spectrumtype)` returns PSD estimates if `spectrumtype` is specified as `'psd'` and returns power spectrum estimates if `spectrumtype` is specified as `'power'`.

`[___] = spectrogram(___, 'MinThreshold',thresh)` sets to zero those elements of `ps` such that $10 \log_{10}(ps) \leq \text{thresh}$. Specify `thresh` in decibels.

`spectrogram(___)` with no output arguments plots the spectrogram in the current figure window.

`spectrogram(___ , freqloc)` specifies the axis on which to plot the frequency.

Examples

Default Values of Spectrogram

Generate $N_x = 1024$ samples of a signal that consists of a sum of sinusoids. The normalized frequencies of the sinusoids are $2\pi/5$ rad/sample and $4\pi/5$ rad/sample. The higher frequency sinusoid has 10 times the amplitude of the other sinusoid.

```
N = 1024;  
n = 0:N-1;  
  
w0 = 2*pi/5;  
x = sin(w0*n)+10*sin(2*w0*n);
```

Compute the short-time Fourier transform using the function defaults. Plot the spectrogram.

```
s = spectrogram(x);  
  
spectrogram(x, 'yaxis')
```

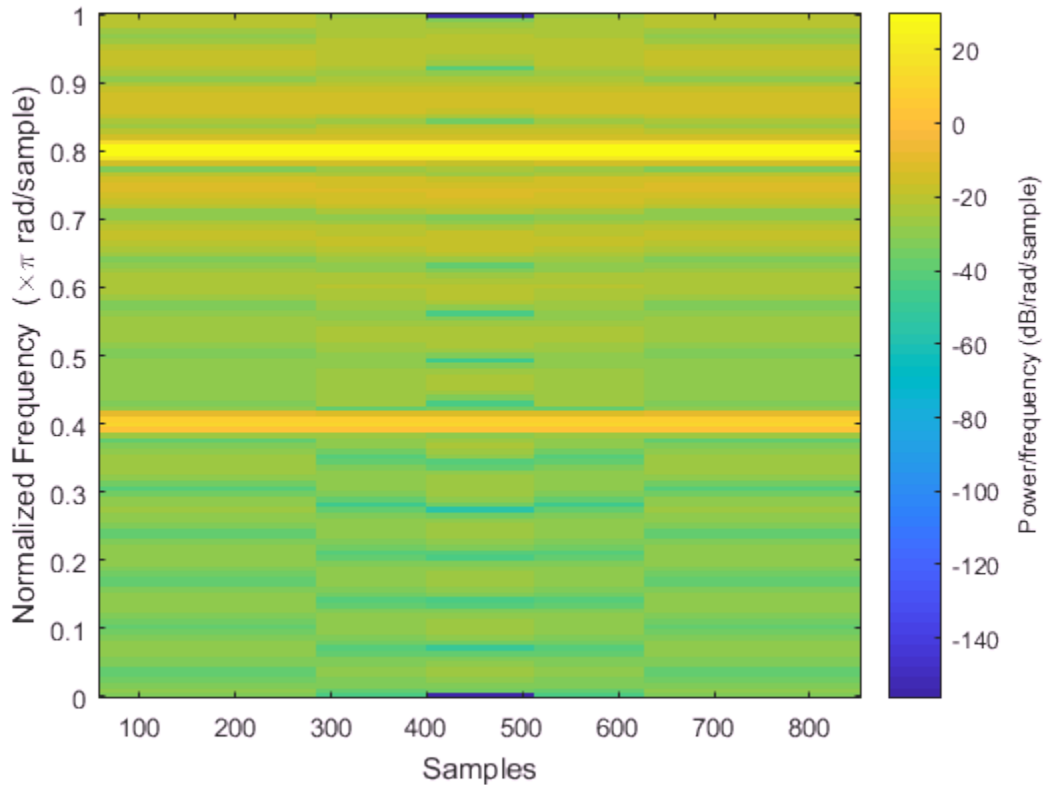

Repeat the computation.

- Divide the signal into sections of length $nsc = \lfloor N_x/4.5 \rfloor$.
- Window the sections using a Hamming window.
- Specify 50% overlap between contiguous sections.
- To compute the FFT, use $\max(256, 2^p)$ points, where $p = \lceil \log_2 N_x \rceil$.

Verify that the two approaches give identical results.

```
Nx = length(x);
nsc = floor(Nx/4.5);
```

```

nov = floor(nsc/2);
nff = max(256,2^nextpow2(nsc));

t = spectrogram(x,hamming(nsc),nov,nff);

maxerr = max(abs(abs(t(:))-abs(s(:))))

maxerr = 0

```

Divide the signal into 8 sections of equal length, with 50% overlap between sections. Specify the same FFT length as in the preceding step. Compute the short-time Fourier transform and verify that it gives the same result as the previous two procedures.

```

ns = 8;
ov = 0.5;
lsc = floor(Nx/(ns-(ns-1)*ov));

t = spectrogram(x,lsc,floor(ov*lsc),nff);

maxerr = max(abs(abs(t(:))-abs(s(:))))

maxerr = 0

```

Frequency Along x-Axis

Generate a quadratic chirp, x , sampled at 1 kHz for 2 seconds. The frequency of the chirp is 100 Hz initially and crosses 200 Hz at $t = 1$ s.

```

t = 0:0.001:2;
x = chirp(t,100,1,200,'quadratic');

```

Compute and display the spectrogram of x .

- Divide the signal into sections of length 128, windowed with a Hamming window.
- Specify 120 samples of overlap between adjoining sections.
- Evaluate the spectrum at $\lfloor 128/2 + 1 \rfloor = 65$ frequencies and $\lfloor (\text{length}(x) - 120)/(128 - 120) \rfloor = 235$ time bins.

```

spectrogram(x,128,120,128,1e3)

```

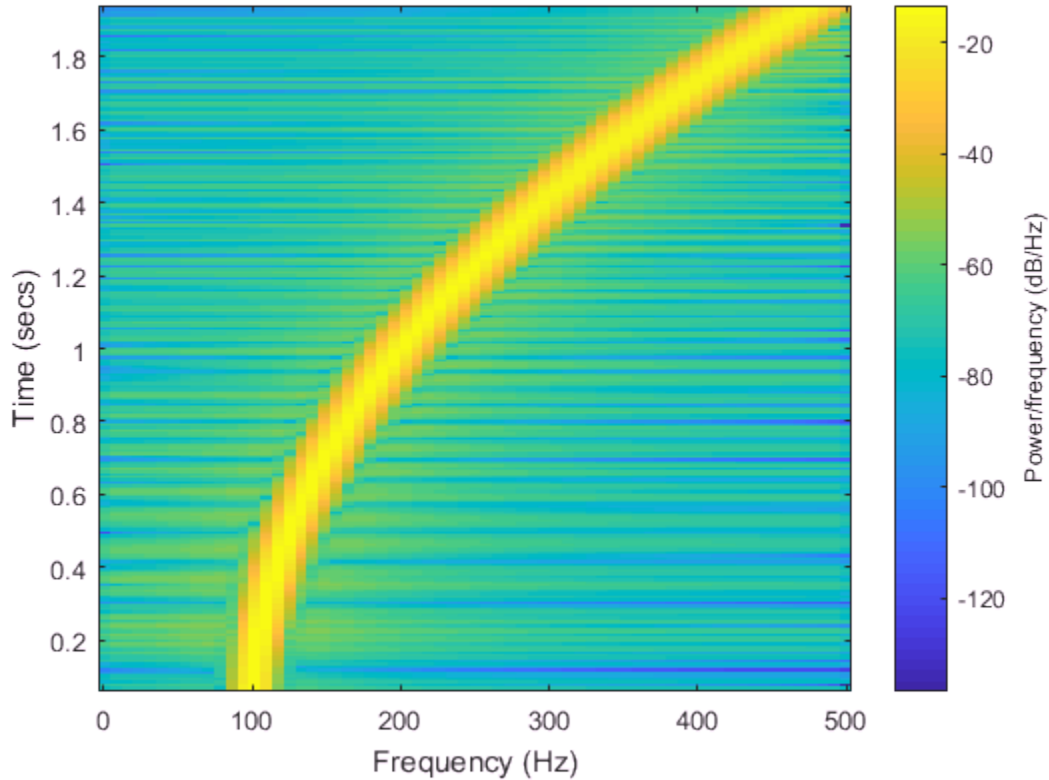

Replace the Hamming window with a Blackman window. Decrease the overlap to 60 samples. Plot the time axis so that its values increase from top to bottom.

```
spectrogram(x,blackman(128),60,128,1e3)  
ax = gca;  
ax.YDir = 'reverse';
```

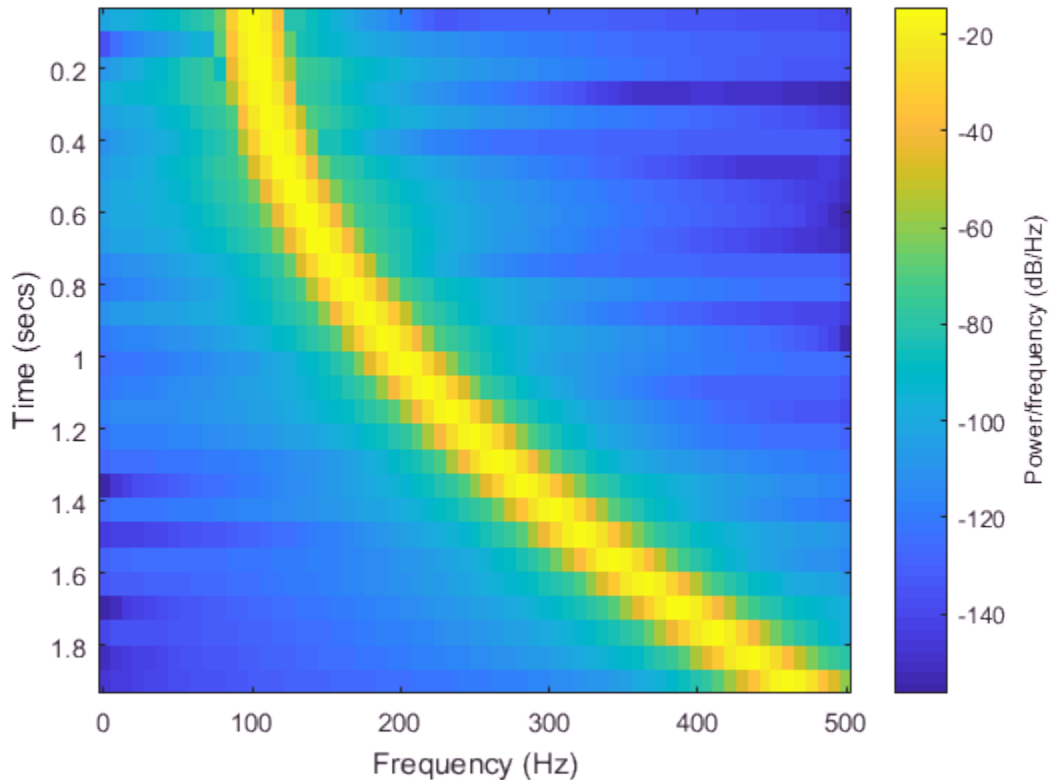

Power Spectral Densities of Chirps

Compute and display the PSD of each segment of a quadratic chirp that starts at 100 Hz and crosses 200 Hz at $t = 1$ s. Specify a sample rate of 1 kHz, a segment length of 128 samples, and an overlap of 120 samples. Use 128 DFT points and the default Hamming window.

```
t = 0:0.001:2;  
x = chirp(t,100,1,200,'quadratic');  
  
spectrogram(x,128,120,128,1e3,'yaxis')  
title('Quadratic Chirp')
```

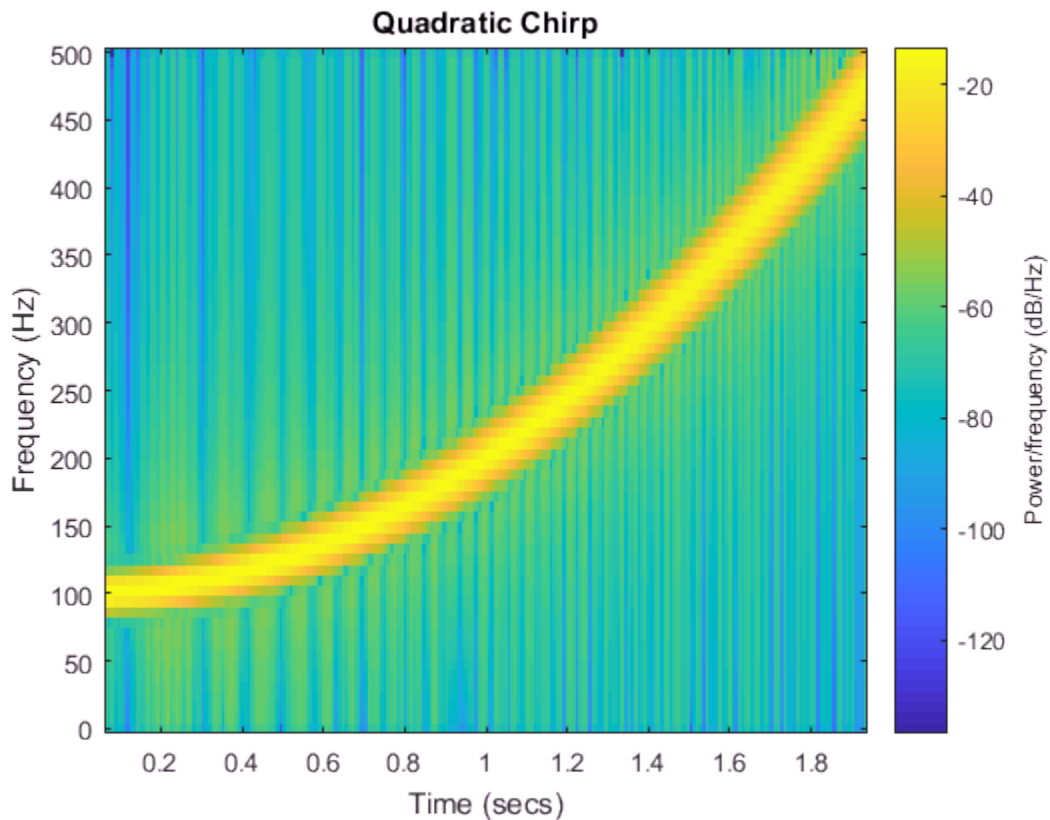

Compute and display the PSD of each segment of a linear chirp that starts at DC and crosses 150 Hz at $t = 1$ s. Specify a sample rate of 1 kHz, a segment length of 256 samples, and an overlap of 250 samples. Use the default Hamming window and 256 DFT points.

```
t = 0:0.001:2;  
x = chirp(t,0,1,150);  
  
spectrogram(x,256,250,256,1e3, 'yaxis')  
title('Linear Chirp')
```

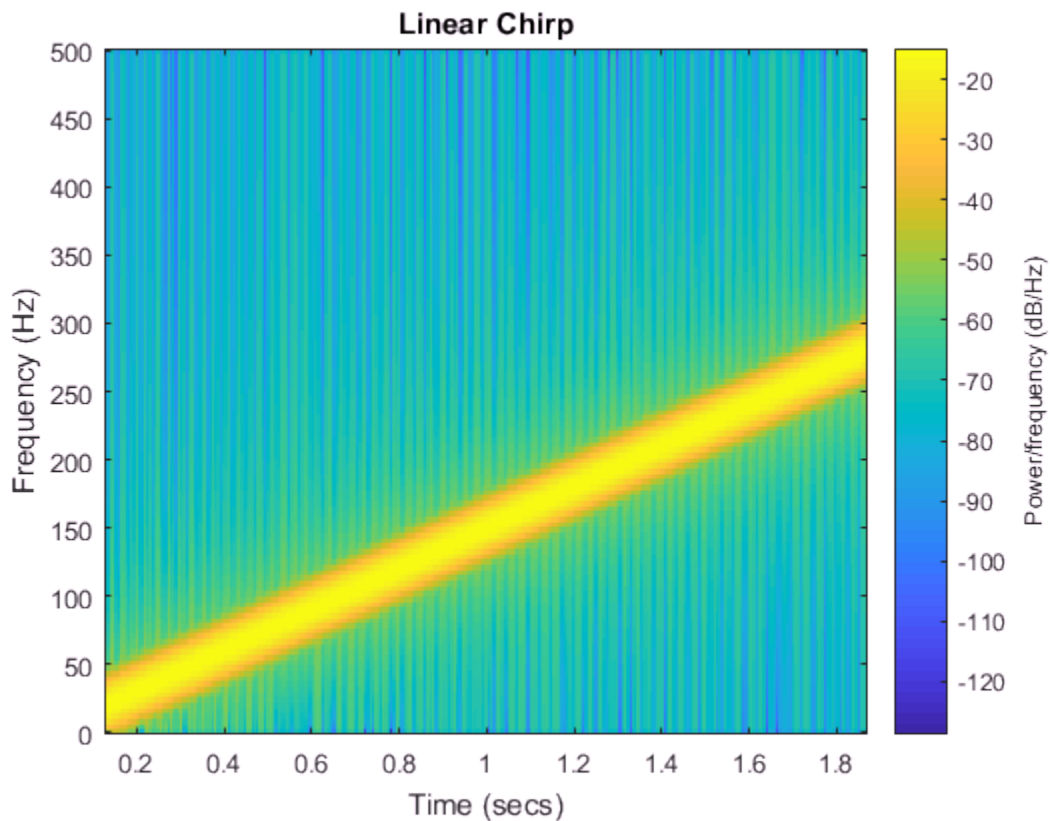
Compute and display the PSD of each segment of a logarithmic chirp sampled at 1 kHz that starts at 20 Hz and crosses 60 Hz at $t = 1$ s. Specify a segment length of 256 samples and an overlap of 250 samples. Use the default Hamming window and 256 DFT points.

```
t = 0:0.001:2;  
x = chirp(t,20,1,60,'logarithmic');  
  
spectrogram(x,256,250,[],1e3,'yaxis')  
title('Logarithmic Chirp')
```

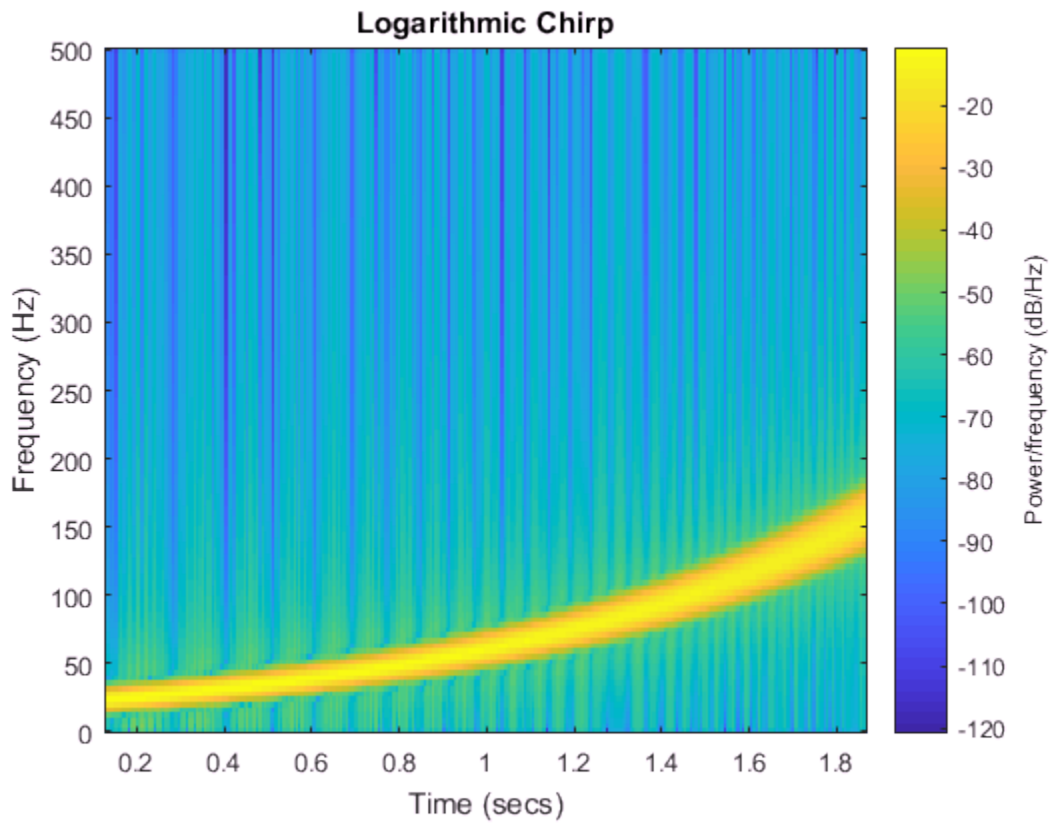

Use a logarithmic scale for the frequency axis. The spectrogram becomes a line.

```
ax = gca;  
ax.YScale = 'log';
```

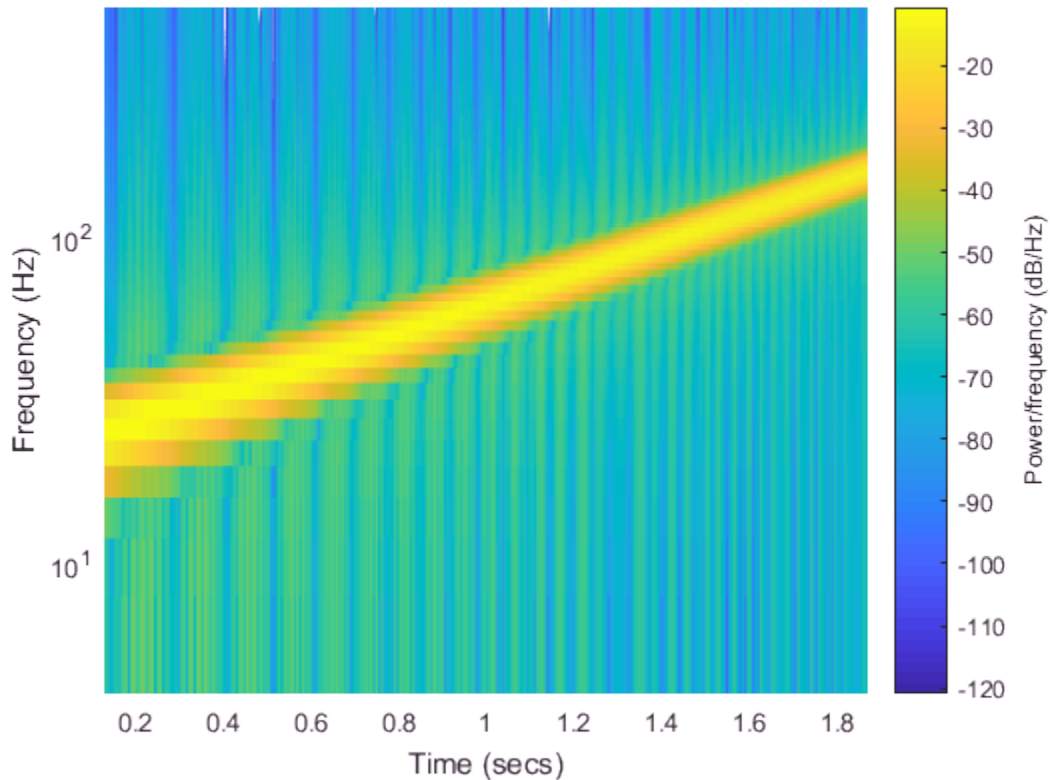

Spectrogram and Instantaneous Frequency

Use the `spectrogram` function to measure and track the instantaneous frequency of a signal.

Generate a quadratic chirp sampled at 1 kHz for two seconds. Specify the chirp so that its frequency is initially 100 Hz and increases to 200 Hz after one second.

```
Fs = 1000;  
t = 0:1/Fs:2-1/Fs;  
y = chirp(t,100,1,200,'quadratic');
```

Estimate the spectrum of the chirp using the short-time Fourier transform implemented in the `spectrogram` function. Divide the signal into sections of length 100, windowed

with a Hamming window. Specify 80 samples of overlap between adjoining sections and evaluate the spectrum at $\lfloor 100/2 + 1 \rfloor = 51$ frequencies. Suppress the default color bar.

```
spectrogram(y,100,80,100,Fs,'yaxis')
view(-77,72)
shading interp
colorbar off
```

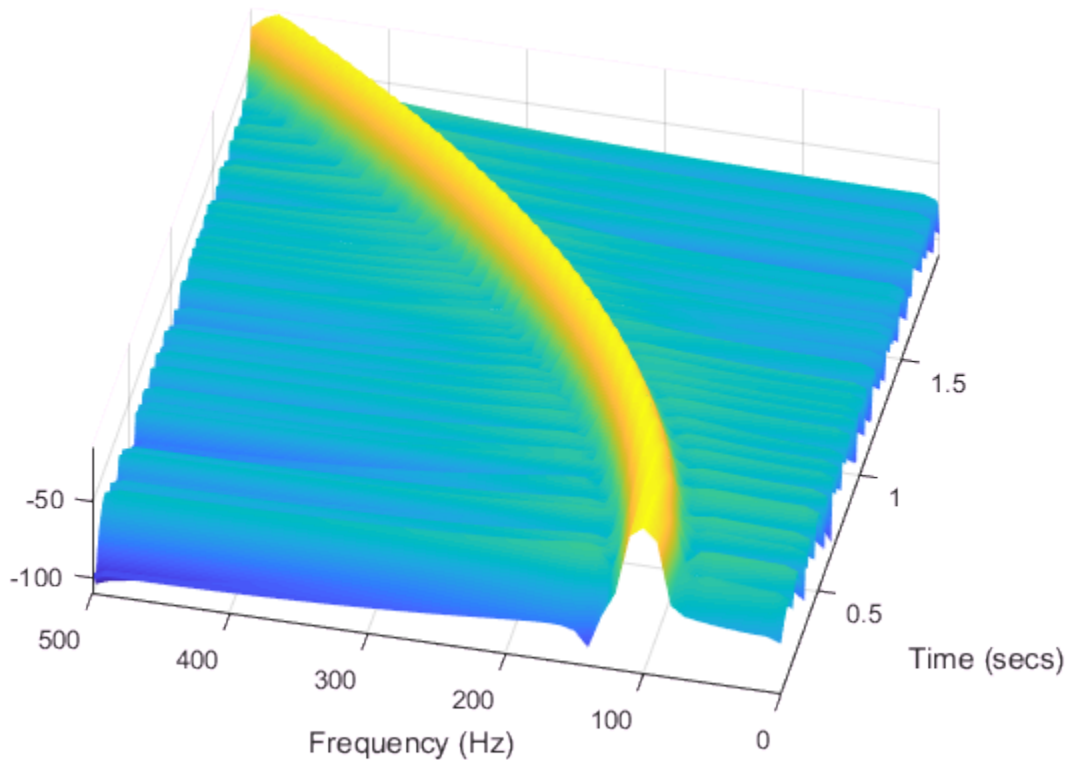

Track the chirp frequency by finding the maximum of the power spectral density at each of the $\lfloor (2000 - 80)/(100 - 80) \rfloor = 96$ time points. View the spectrogram as a two-dimensional graphic. Restore the color bar.

```
[s,f,t,p] = spectrogram(y,100,80,100,Fs);
```

```
[q,nd] = max(10*log10(p));  
  
hold on  
plot3(t,f(nd),q,'r','linewidth',4)  
hold off  
colorbar  
view(2)
```

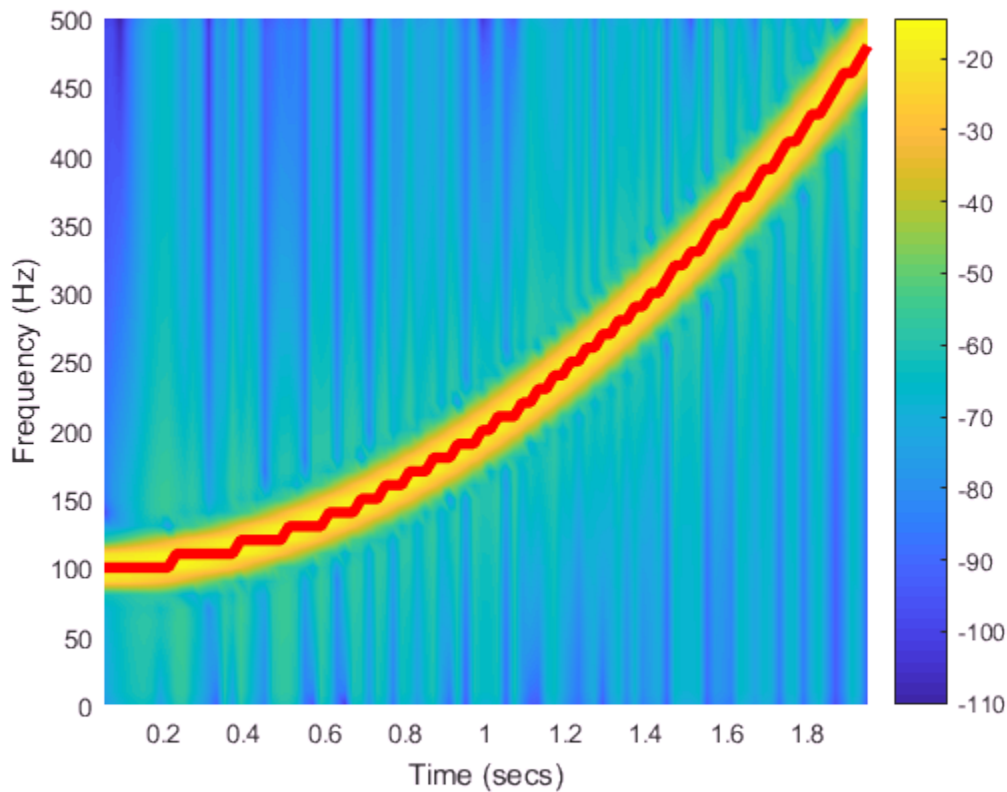

Reassigned Spectrogram of Quadratic Chirp

Generate a chirp signal sampled for 2 seconds at 1 kHz. Specify the chirp so that its frequency is initially 100 Hz and increases to 200 Hz after 1 second.

```
Fs = 1000;  
t = 0:1/Fs:2;  
y = chirp(t,100,1,200, 'quadratic');
```

Estimate the reassigned spectrogram of the signal.

- Divide the signal into sections of length 128, windowed with a Kaiser window with shape parameter $\beta = 18$.
- Specify 120 samples of overlap between adjoining sections.
- Evaluate the spectrum at $\lfloor 128/2 \rfloor = 65$ frequencies and $\lfloor (\text{length}(x) - 120)/(128 - 120) \rfloor = 235$ time bins.

```
spectrogram(y,kaiser(128,18),120,128,Fs, 'reassigned', 'yaxis')
```

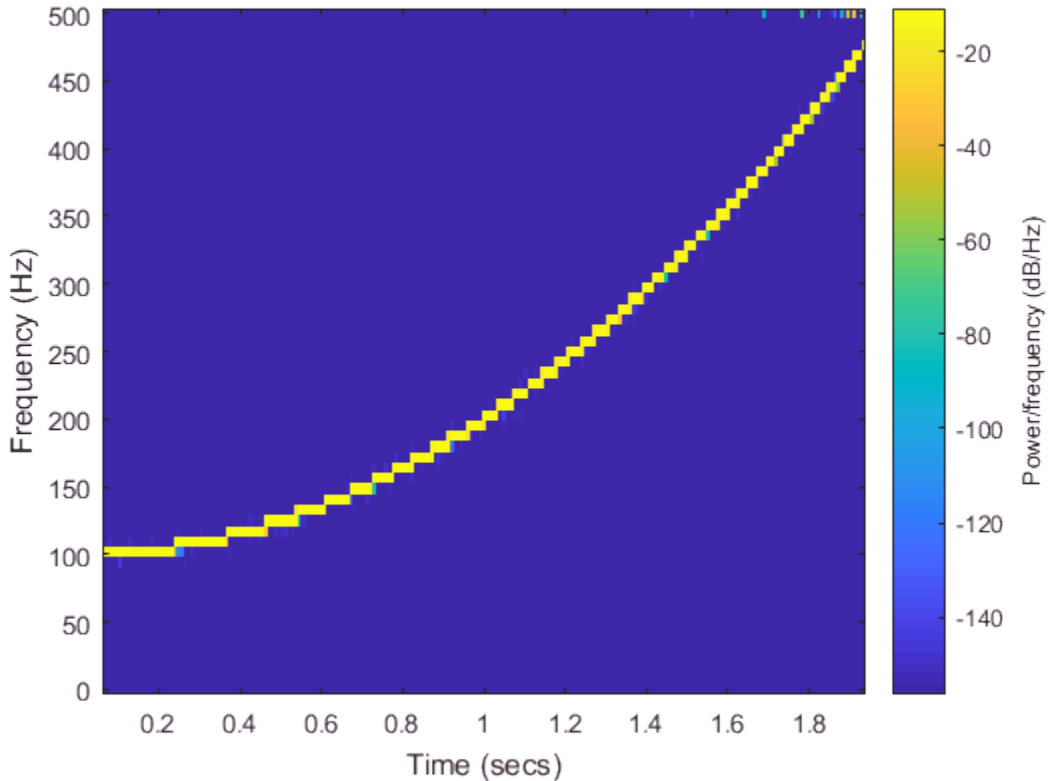

Spectrogram with Threshold

Generate a chirp signal sampled for 2 seconds at 1 kHz. Specify the chirp so that its frequency is initially 100 Hz and increases to 200 Hz after 1 second.

```
Fs = 1000;  
t = 0:1/Fs:2;  
y = chirp(t,100,1,200,'quadratic');
```

Estimate the time-dependent power spectral density (PSD) of the signal.

- Divide the signal into sections of length 128, windowed with a Kaiser window with shape parameter $\beta = 18$.

- Specify 120 samples of overlap between adjoining sections.
- Evaluate the spectrum at $\lfloor 128/2 \rfloor = 65$ frequencies and $\lfloor (\text{length}(x) - 120)/(128 - 120) \rfloor = 235$ time bins.

Output the frequency and time of the center of gravity of each PSD estimate. Set to zero those elements of the PSD smaller than -30 dB.

```
[~,~,~,pxx,fc,tc] = spectrogram(y,kaiser(128,18),120,128,Fs, ...  
    'MinThreshold',-30);
```

Plot the nonzero elements as functions of the center-of-gravity frequencies and times.

```
plot(tc(pxx>0),fc(pxx>0),'.')
```

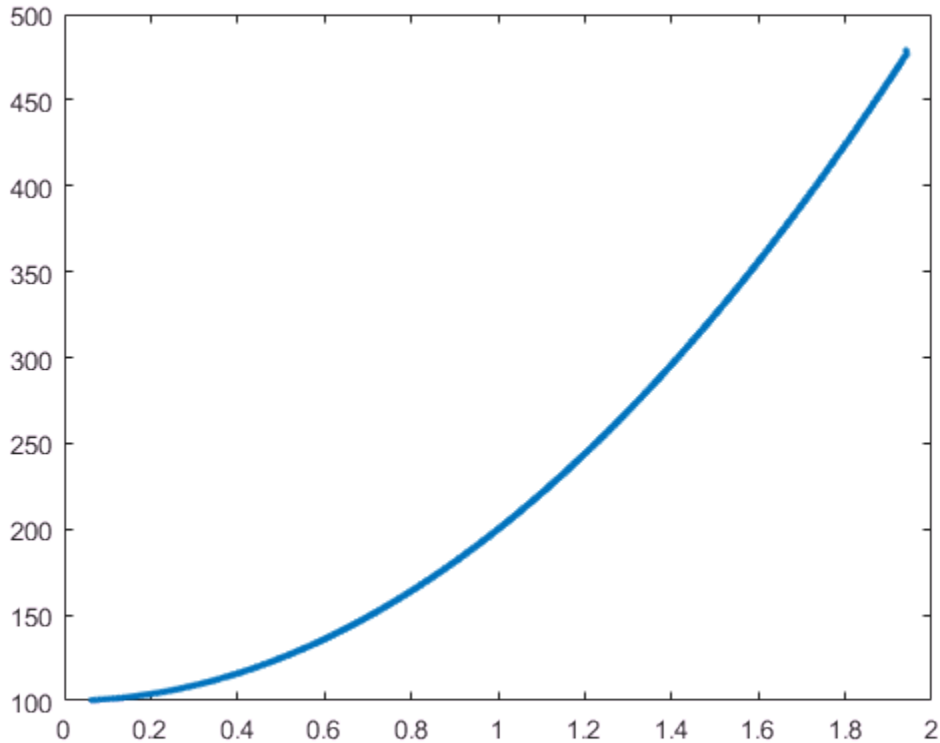
Spectrogram Reassignment and Thresholding

Generate a signal sampled at 1024 Hz for 2 seconds.

```
nSamp = 2048;  
Fs = 1024;  
t = (0:nSamp-1)' / Fs;
```

During the first second, the signal consists of a 400 Hz sinusoid and a concave quadratic chirp. Specify the chirp so that it is symmetric about the interval midpoint, starting and ending at a frequency of 250 Hz and attaining a minimum of 150 Hz.

```
t1 = t(1:nSamp/2);
```

```
x11 = sin(2*pi*400*t1);  
x12 = chirp(t1-t1(nSamp/4),150,nSamp/Fs,1750,'quadratic');  
x1 = x11+x12;
```

The rest of the signal consists of two linear chirps of decreasing frequency. One chirp has an initial frequency of 250 Hz that decreases to 100 Hz. The other chirp has an initial frequency of 400 Hz that decreases to 250 Hz.

```
t2 = t(nSamp/2+1:nSamp);  
  
x21 = chirp(t2,400,nSamp/Fs,100);  
x22 = chirp(t2,550,nSamp/Fs,250);  
x2 = x21+x22;
```

Add white Gaussian noise to the signal. Specify a signal-to-noise ratio of 20 dB. Reset the random number generator for reproducible results.

```
SNR = 20;  
rng('default')  
  
sig = [x1;x2];  
sig = sig + randn(size(sig))*std(sig)/db2mag(SNR);
```

Compute and plot the spectrogram of the signal. Specify a Kaiser window of length 63 with a shape parameter $\beta = 17$, 10 fewer samples of overlap between adjoining sections, and an FFT length of 256.

```
nwin = 63;  
wind = kaiser(nwin,17);  
nlap = nwin-10;  
nfft = 256;  
  
spectrogram(sig,wind,nlap,nfft,Fs,'yaxis')
```

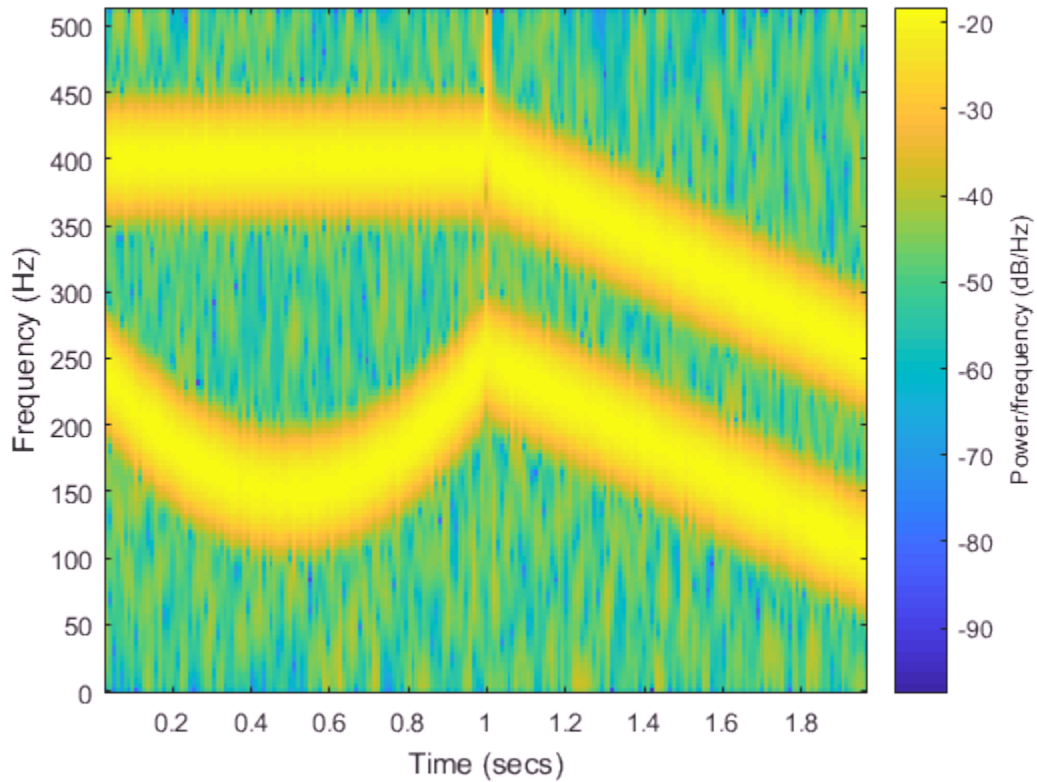

Threshold the spectrogram so that any elements with values smaller than the SNR are set to zero.

```
spectrogram(sig,wind,nlap,nfft,Fs,'MinThreshold',-SNR,'yaxis')
```

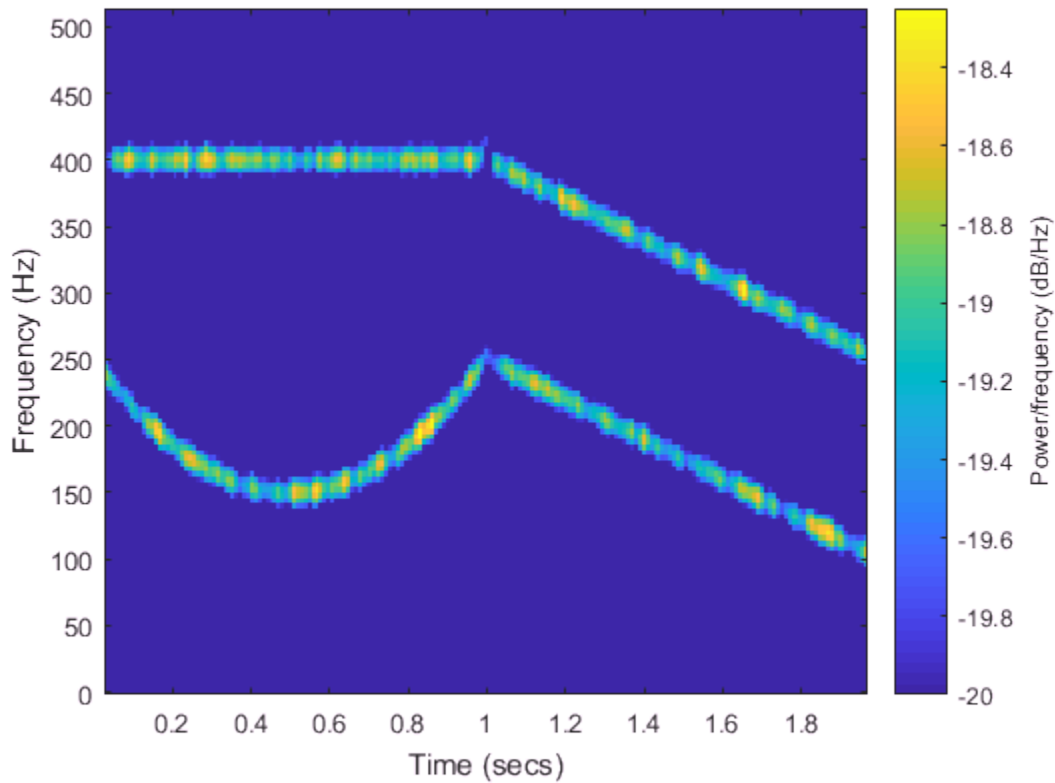

Reassign each PSD estimate to the location of its center of energy.

```
spectrogram(sig,wind,nlap,nfft,Fs,'reassign','yaxis')
```

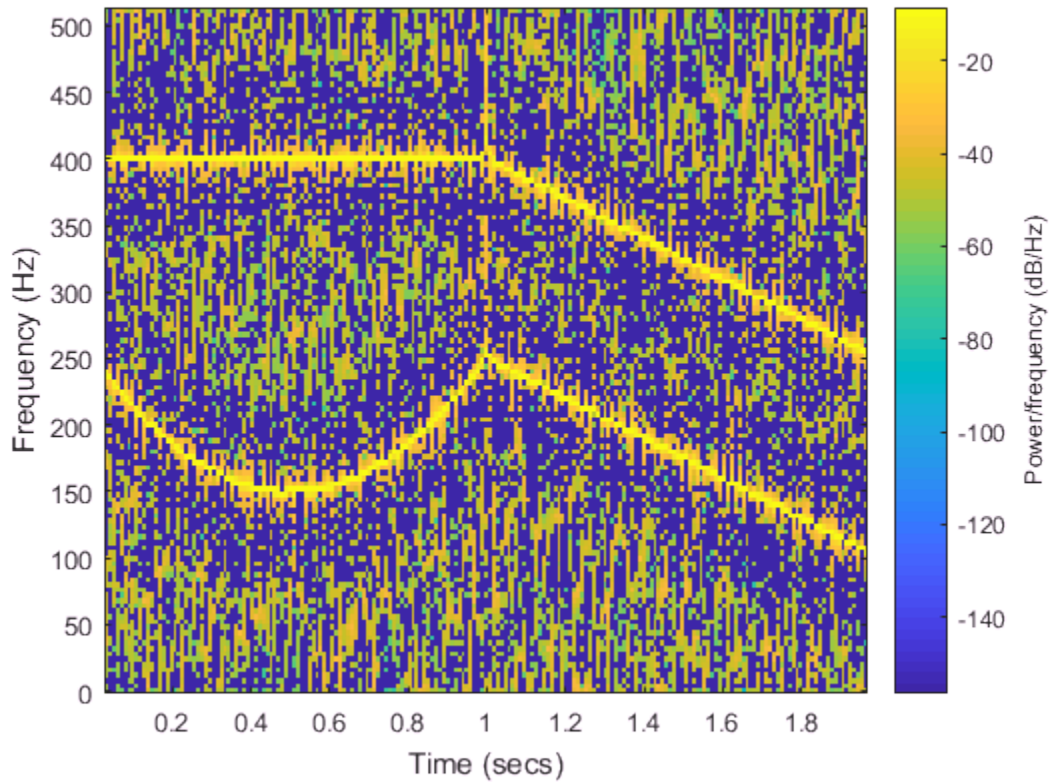

Threshold the reassigned spectrogram so that any elements with values smaller than the SNR are set to zero.

```
spectrogram(sig,wind,nlap,nfft,Fs,'reassign','MinThreshold',-SNR,'yaxis')
```

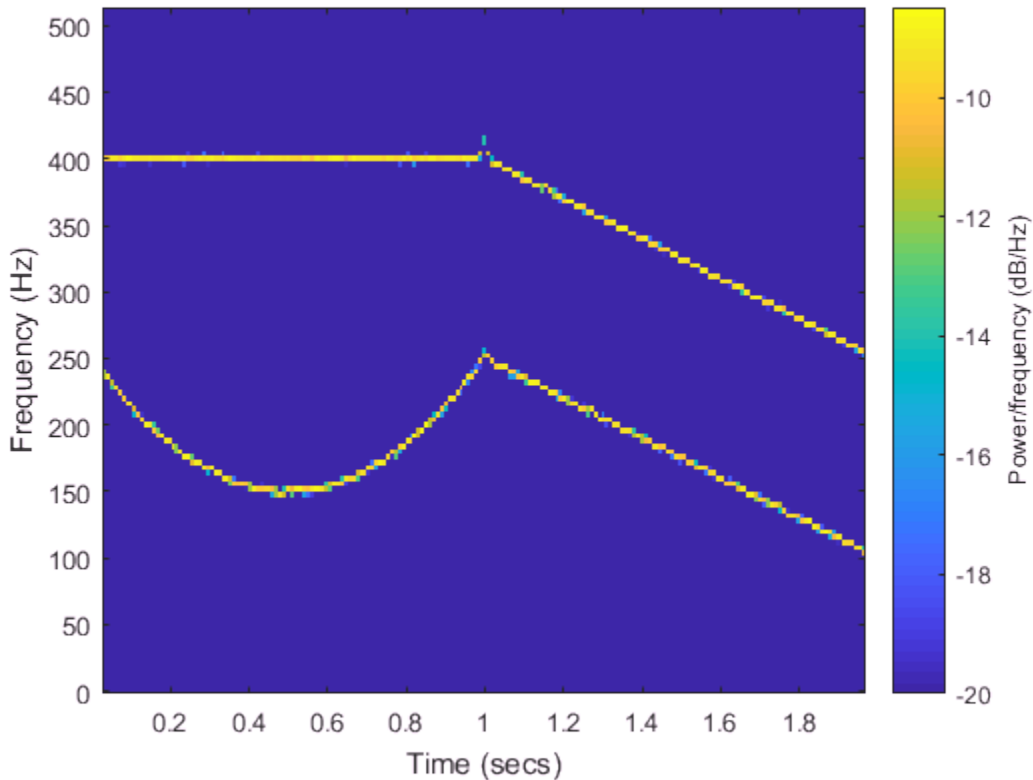

Track Chirps in Audio Signal

Load an audio signal that contains two decreasing chirps and a wideband splatter sound. Compute the short-time Fourier transform. Divide the waveform into 400-sample segments with 300-sample overlap. Plot the spectrogram.

```
load splat
```

```
% To hear, type soundsc(y,Fs)
```

```
sg = 400;
```

```
ov = 300;
```

```
spectrogram(y,sg,ov,[],Fs,'yaxis')
colormap bone
```

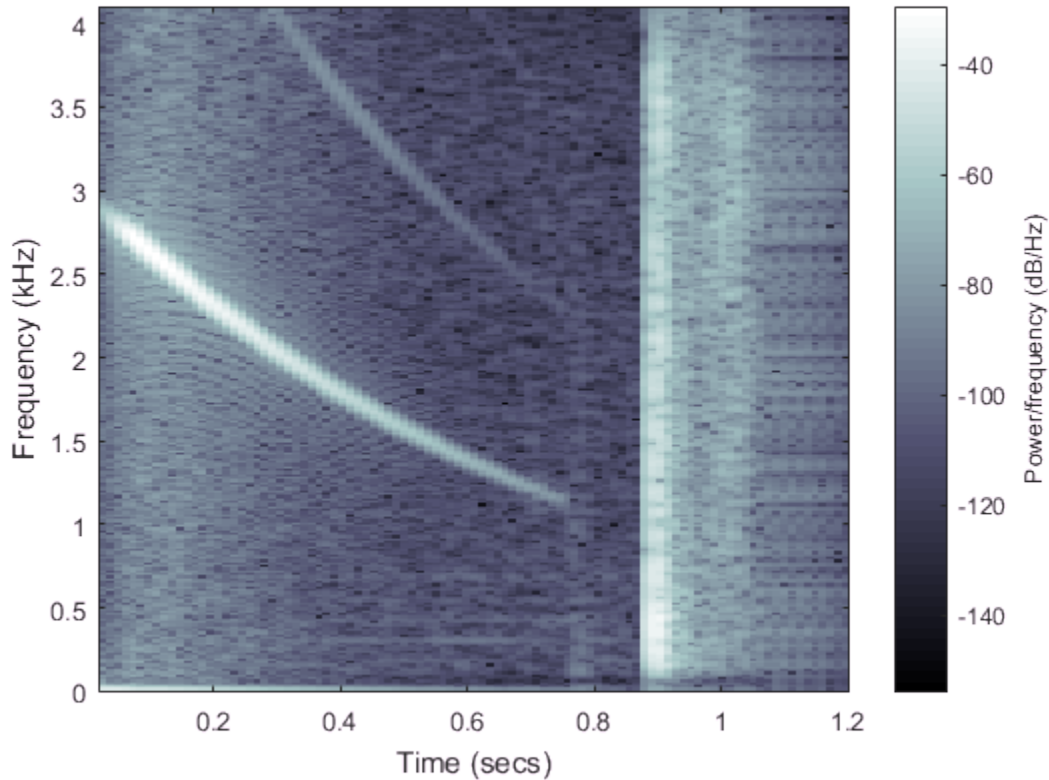

Use the `spectrogram` function to output the power spectral density (PSD) of the signal.

```
[s,f,t,p] = spectrogram(y,sg,ov,[],Fs);
```

Track the two chirps using the `medfreq` function. To find the stronger, low-frequency chirp, restrict the search to frequencies above 100 Hz and to times before the start of the wideband sound.

```
f1 = f > 100;
```

```
t1 = t < 0.75;
```

```
m1 = medfreq(p(f1,t1),f(f1));
```

To find the faint high-frequency chirp, restrict the search to frequencies above 2500 Hz and to times between 0.3 seconds and 0.65 seconds.

```
f2 = f > 2500;  
t2 = t > 0.3 & t < 0.65;  
  
m2 = medfreq(p(f2,t2),f(f2));
```

Overlay the result on the spectrogram. Divide the frequency values by 1000 to express them in kHz.

```
hold on  
plot(t(t1),m1/1000,'linewidth',4)  
plot(t(t2),m2/1000,'linewidth',4)  
hold off
```

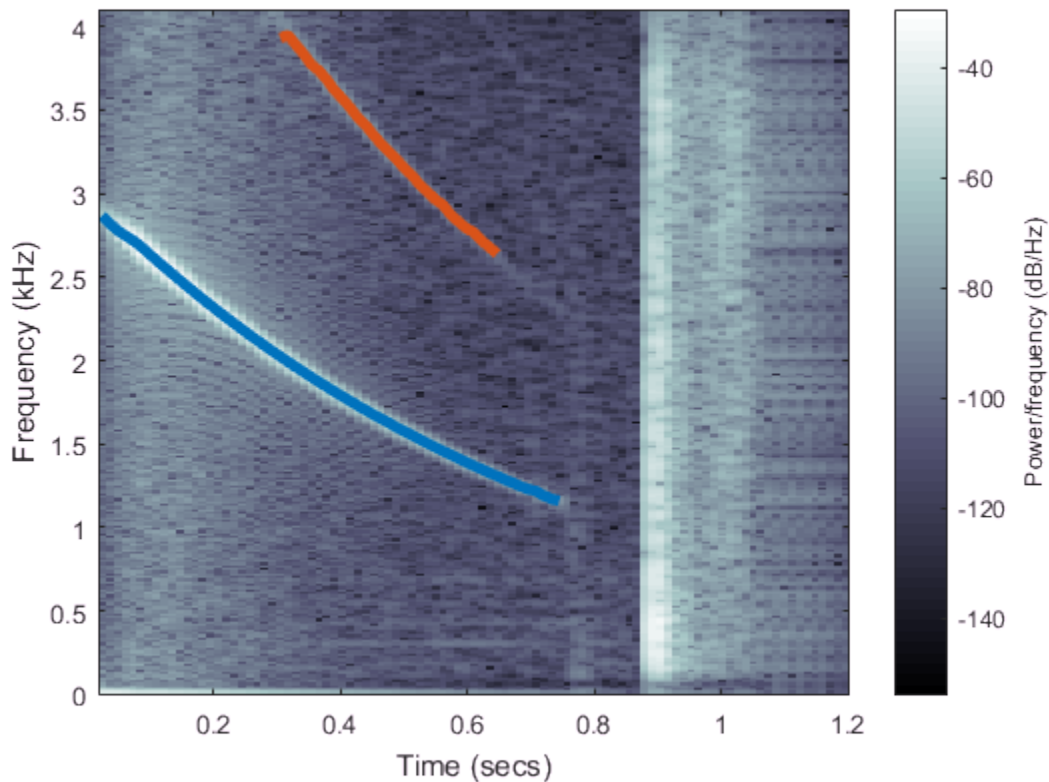

3D Spectrogram Visualization

Generate two seconds of a signal sampled at 10 kHz. Specify the instantaneous frequency of the signal as a triangular function of time.

```
fs = 10e3;  
t = 0:1/fs:2;  
x1 = vco(sawtooth(2*pi*t,0.5),[0.1 0.4]*fs,fs);
```

Compute and plot the spectrogram of the signal. Use a Kaiser window of length 256 and shape parameter $\beta = 5$. Specify 220 samples of section-to-section overlap and 512 DFT points. Plot the frequency on the y -axis. Use the default colormap and view.

```
spectrogram(x1,kaiser(256,5),220,512,fs,'yaxis')
```

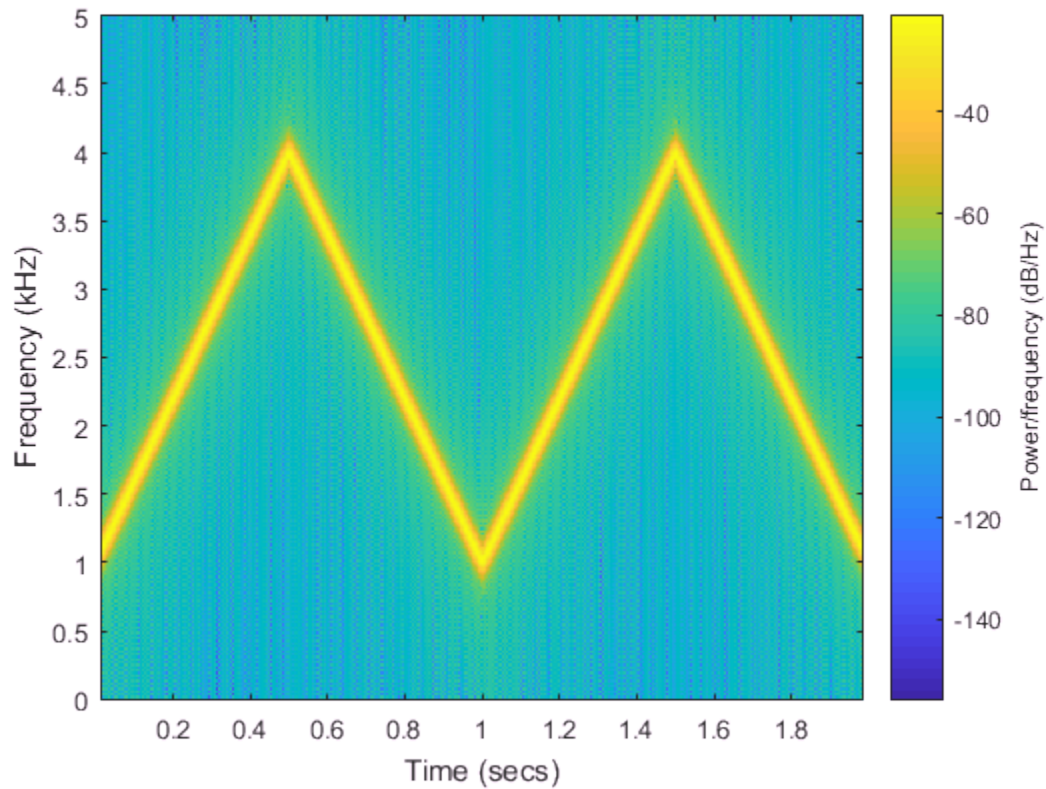

Change the view to display the spectrogram as a waterfall plot. Set the colormap to bone.

```
colormap bone  
view(-45,65)
```

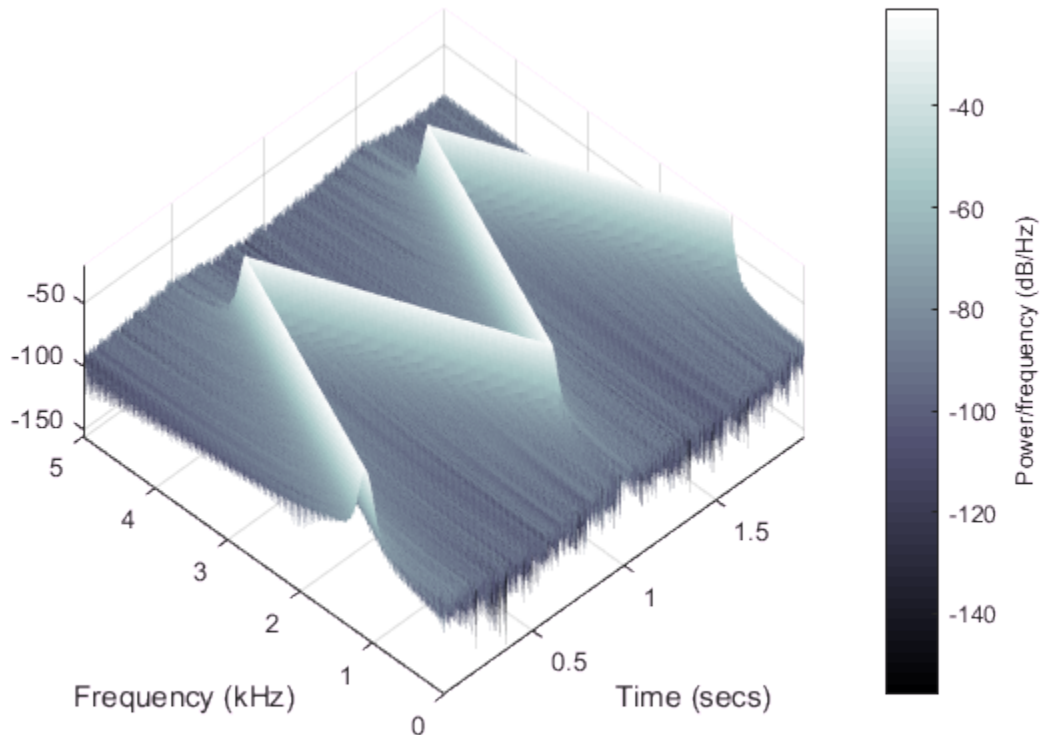

- “Formant Estimation with LPC Coefficients”

Input Arguments

x — Input signal
vector

Input signal, specified as a row or column vector.

Example: `cos(pi/4*(0:159))+randn(1,160)` specifies a sinusoid embedded in white Gaussian noise.

Data Types: `single` | `double`

Complex Number Support: Yes

window — Window

`integer` | `vector` | `[]`

Window, specified as an integer or as a row or column vector. Use `window` to divide the signal into segments:

- If `window` is an integer, then `spectrogram` divides `x` into segments of length `window` and windows each segment with a Hamming window of that length.
- If `window` is a vector, then `spectrogram` divides `x` into segments of the same length as the vector and windows each segment using `window`.

If the length of `x` cannot be divided exactly into an integer number of segments with `noverlap` overlapping samples, then `x` is truncated accordingly.

If you specify `window` as empty, then `spectrogram` uses a Hamming window such that `x` is divided into eight segments with `noverlap` overlapping samples.

For a list of available windows, see “Windows”.

Example: `hann(N+1)` and `(1 - cos(2*pi*(0:N)'/N))/2` both specify a Hann window of length `N + 1`.

Data Types: `single` | `double`

noverlap — Number of overlapped samples

`positive integer` | `[]`

Number of overlapped samples, specified as a positive integer.

- If `window` is scalar, then `noverlap` must be smaller than `window`.
- If `window` is a vector, then `noverlap` must be smaller than the length of `window`.

If you specify `noverlap` as empty, then `spectrogram` uses a number that produces 50% overlap between segments. If the segment length is unspecified, the function sets `noverlap` to $\lfloor N_x/4.5 \rfloor$, where N_x is the length of the input signal.

Data Types: `double` | `single`

nfft — Number of DFT points

`positive integer scalar` | `[]`

Number of DFT points, specified as a positive integer scalar. If you specify `nfft` as empty, then `spectrogram` sets the parameter to $\max(256, 2^p)$, where $p = \lceil \log_2 N_x \rceil$ for an input signal of length N_x .

Data Types: `single` | `double`

w — Normalized frequencies

vector

Normalized frequencies, specified as a vector. `w` must have at least two elements. Normalized frequencies are in rad/sample.

Example: `pi./[2 4]`

Data Types: `double` | `single`

f — Cyclical frequencies

vector

Cyclical frequencies, specified as a vector. `f` must have at least two elements. The units of `f` are specified by the sample rate, `fs`.

Data Types: `double` | `single`

fs — Sample rate

1 Hz (default) | positive scalar

Sample rate, specified as a positive scalar. The sample rate is the number of samples per unit time. If the unit of time is seconds, then the sample rate is in Hz.

Data Types: `double` | `single`

freange — Frequency range for PSD estimate

'onesided' | 'twosided' | 'centered'

Frequency range for the PSD estimate, specified as 'onesided', 'twosided', or 'centered'. For real-valued signals, the default is 'onesided'. For complex-valued signals, the default is 'twosided', and specifying 'onesided' results in an error.

- 'onesided' — returns the one-sided spectrogram of a real input signal. If `nfft` is even, then `ps` has $nfft/2 + 1$ rows and is computed over the interval $[0, \pi]$ rad/sample. If `nfft` is odd, then `ps` has $(nfft + 1)/2$ rows and the interval is $[0, \pi)$ rad/sample. If you specify `fs`, then the intervals are respectively $[0, fs/2]$ cycles/unit time and $[0, fs/2)$ cycles/unit time.

- `'twosided'` — returns the two-sided spectrogram of a real or complex signal. `ps` has `nfft` rows and is computed over the interval $[0, 2\pi)$ rad/sample. If you specify `fs`, then the interval is $[0, fs)$ cycles/unit time.
- `'centered'` — returns the centered two-sided spectrogram of a real or complex signal. `ps` has `nfft` rows. If `nfft` is even, then `ps` is computed over the interval $(-\pi, \pi]$ rad/sample. If `nfft` is odd, then `ps` is computed over $(-\pi, \pi)$ rad/sample. If you specify `fs`, then the intervals are respectively $(-fs/2, fs/2]$ cycles/unit time and $(-fs/2, fs/2)$ cycles/unit time.

Data Types: char

spectrumtype — Power spectrum scaling

`'psd'` (default) | `'power'`

Power spectrum scaling, specified as `'psd'` or `'power'`.

- Omitting `spectrumtype`, or specifying `'psd'`, returns the power spectral density.
- Specifying `'power'` scales each estimate of the PSD by the equivalent noise bandwidth of the window. The result is an estimate of the power at each frequency. If the `'reassigned'` option is on, the function integrates the PSD over the width of each frequency bin before reassigning.

Data Types: char

thresh — Threshold

`-Inf` (default) | real scalar

Threshold, specified as a real scalar expressed in decibels. `spectrogram` sets to zero those elements of `ps` such that $10 \log_{10}(ps) \leq thresh$.

freqloc — Frequency display axis

`'xaxis'` (default) | `'yaxis'`

Frequency display axis, specified as `'xaxis'` or `'yaxis'`.

- `'xaxis'` — displays frequency on the x -axis and time on the y -axis.
- `'yaxis'` — displays frequency on the y -axis and time on the x -axis.

This argument is ignored if you call `spectrogram` with output arguments.

Data Types: char

Output Arguments

s — Short-time Fourier transform

matrix

Short-time Fourier transform, returned as a matrix. Time increases across the columns of **s** and frequency increases down the rows, starting from zero.

- If **x** is a signal of length N_x , then **s** has k columns, where
 - $k = \lfloor (N_x - \text{noverlap}) / (\text{window} - \text{noverlap}) \rfloor$ if **window** is a scalar
 - $k = \lfloor (N_x - \text{noverlap}) / (\text{length}(\text{window}) - \text{noverlap}) \rfloor$ if **window** is a vector.
- If **x** is real and **nfft** is even, then **s** has $(\text{nfft}/2 + 1)$ rows.
- If **x** is real and **nfft** is odd, then **s** has $(\text{nfft} + 1)/2$ rows.
- If **x** is complex, then **s** has **nfft** rows.

Data Types: double | single

w — Normalized frequencies

vector

Normalized frequencies, returned as a vector. **w** has a length equal to the number of rows of **s**.

Data Types: double | single

t — Time instants

vector

Time instants, returned as a vector. The time values in **t** correspond to the midpoint of each segment.

Data Types: double | single

f — Cyclical frequencies

vector

Cyclical frequencies, returned as a vector. **f** has a length equal to the number of rows of **s**.

Data Types: double | single

ps — Power spectral density or power spectrum

matrix

Power spectral density (PSD) or power spectrum, returned as a matrix.

- If x is real, then **ps** contains the one-sided modified periodogram estimate of the PSD or power spectrum of each segment.
- If x is complex, or if you specify a vector of frequencies, then **ps** contains the two-sided modified periodogram estimate of the PSD or power spectrum of each segment.

Data Types: `double` | `single`**fc, tc** — Center-of-energy frequencies and times

matrices

Center-of-energy frequencies and times, returned as matrices of the same size as the short-time Fourier transform. If you do not specify a sample rate, then the elements of **fc** are returned as normalized frequencies.

Tips

If a short-time Fourier transform has zeros, its conversion to decibels results in negative infinities that cannot be plotted. To avoid this potential difficulty, **spectrogram** adds **eps** to the short-time Fourier transform when you call it with no output arguments.

References

- [1] Oppenheim, Alan V., Ronald W. Schaffer, and John R. Buck. *Discrete-Time Signal Processing*. 2nd Ed. Upper Saddle River, NJ: Prentice Hall, 1999.
- [2] Rabiner, Lawrence R., and Ronald W. Schaffer. *Digital Processing of Speech Signals*. Englewood Cliffs, NJ: Prentice-Hall, 1978.
- [3] Chassande-Motin, Éric, François Auger, and Patrick Flandrin. “Reassignment.” In *Time-Frequency Analysis: Concepts and Methods*. Edited by Franz Hlawatsch and François Auger. London: ISTE/John Wiley and Sons, 2008.
- [4] Fulop, Sean A., and Kelly Fitz. “Algorithms for computing the time-corrected instantaneous frequency (reassigned) spectrogram, with applications.” *Journal of the Acoustical Society of America*. Vol.119, January 2006, pp.360–371.

See Also

See Also

goertzel | periodogram | pwelch

Topics

“Formant Estimation with LPC Coefficients”

Introduced before R2006a

spectrum

Spectral estimation

Syntax

```
Hs = spectrum.estimate(input1, ...)
```

Description

Note: The use of `spectrum.estimate` is not recommended. Use the corresponding function instead. See [Spectrum Estimation Methods](#) for the functional forms.

`Hs = spectrum.estimate(input1, ...)` returns a spectral estimation object `Hs` of type `estimate`. This object contains all the parameter information needed for the specified estimation method. Each estimation method takes one or more inputs, which are described on the individual reference pages.

Estimation Methods

Estimation methods for `spectrum` specify the type of spectral estimation method to use. Available estimation methods for `spectrum` are listed below.

Note You must use a spectral `estimate` with `spectrum`.

Spectrum Estimation Methods

<code>spectrum.estimate</code>	Description	Corresponding Function
<code>spectrum.burg</code>	Burg	<code>pburg</code>
<code>spectrum.cov</code>	Covariance	<code>pcov</code>
<code>spectrum.eigenvector</code>	Eigenvector	<code>peig</code>
<code>spectrum.mcov</code>	Modified covariance	<code>pmcov</code>

spectrum.estmethod	Description	Corresponding Function
spectrum.mtm	Thompson multitaper	pmtm
spectrum.music	Multiple Signal Classification	pmusic
spectrum.periodogram	Periodogram	periodogram
spectrum.welch	Welch	pwelch
spectrum.yulear	Yule-Walker	pyulear

For more information on each estimation method, use the syntax `help spectrum.estmethod` at the MATLAB prompt or refer to its reference page.

Note For estimation methods that use overlap and window length inputs, you specify the number of overlap samples as a percent overlap and you specify the segment length instead of the window length.

For estimation methods that use windows, if the window uses an additional parameter, a property is dynamically added to the spectrum object for that parameter. You can change that property using `set` (see “Changing Object Properties” on page 1-2221).

Methods

Methods provide ways of performing functions directly on your `spectrum` object without having to specify the spectral estimation parameters again. You can apply these methods directly on the variable you assigned to your `spectrum` object. For more information on any of these methods, use the syntax `help spectrum/method` at the MATLAB prompt or refer to the table below.

Spectrum Methods

Method	Description
msspectrum	<p>Note that the <code>msspectrum</code> method is only available for the <code>periodogram</code> and <code>welch</code> spectrum estimation objects.</p> <p>The mean-squared spectrum is intended for discrete spectra (from periodic, discrete-time signals). The distribution of the mean square value across frequency is the <code>msspectrum</code>. Unlike the power spectral density (see <code>psd</code> below), the peaks in the mean-square spectrum reflect the power in the signal at a given frequency. For the PSD, the power is reflected as the area</p>

Method	Description
	<p>in a frequency band. The units of the mean-squared spectrum are units of power.</p> <p><code>Hmss = msspectrum(Hs,X)</code> returns a mean-square spectrum object containing the mean-square (power) estimate of the discrete-time signal <code>X</code> using the spectrum object <code>Hs</code>. Default for real <code>X</code> is the <code>'onesided'</code> Nyquist frequency range and for complex <code>X</code> the default is the <code>'twosided'</code> Nyquist frequency range.</p> <p><code>Hmss</code> contains a vector of normalized frequencies <code>W</code>, at which the mean-square spectrum is estimated. For real signals, the range of <code>W</code> is <code>[0,π]</code> if the number of FFT points (<code>NFFT</code>) is even, and <code>[0,π)</code> if <code>NFFT</code> is odd. For complex signals, the range of <code>W</code> is <code>[0,2π)</code>. To estimate the spectrum on a vector of specific frequencies, see <code>FreqPoints</code> property below.</p> <p>The <code>msspectrum</code> method includes these properties, which you can set using this <code>msspectrum</code> method or via the <code>msspectrumopts</code> method. These properties are listed here and described in the <code>msspectrumopts</code> section below:</p> <p><code>SpectrumType</code> — <code>'onesided'</code> or <code>'twosided'</code> <code>NormalizedFrequency</code> — normalizes frequency between 0 and 1 <code>Fs</code> — sampling frequency in Hz <code>NFFT</code> — number of FFT points <code>CenterDC</code> — shifts data and frequencies to center DC component <code>FreqPoints</code> — <code>'All'</code> or <code>'User Defined'</code> <code>FrequencyVector</code> — frequencies at which to compute spectrum <code>ConfLevel</code> — confidence level to calculate the confidence interval. Value must be from 0 to 1.</p> <p>For example, <code>Hmss = msspectrum(Hs,X,'FreqPoints','User Defined', FreqVector,fvect)</code> returns a mean-square spectrum object where the spectrum is calculated only on the frequency points defined in the frequency vector, <code>fvect</code>.</p> <p><code>msspectrum(...)</code> with no output arguments plots the mean-square spectrum in dB.</p>
<code>msspectrumopts</code>	<code>Hopts = msspectrumopts(Hs)</code> returns an object that contains options for the spectrum object <code>Hs</code> .

Method	Description
	<p><code>Hopts = msspectrumopts(Hs,X)</code> returns an object with data-specific options and defaults.</p> <p>You can pass an <code>Hopts</code> options object as an argument to the <code>msspectrum</code> method. Any individual option you specify after the <code>Hopts</code> object overrides the value in <code>Hopts</code>. For example, <code>Hmss = msspectrum(Hs,X,Hopts, 'SpectrumType', 'twosided')</code> overrides the default <code>SpectrumType</code> value in <code>Hopts</code>.</p> <p>The following properties apply to both <code>msspectrumopts</code> and <code>msspectrum</code> methods.</p> <p><code>Hmss = msspectrum(..., 'SpectrumType', 'twosided')</code> returns the two-sided mean-square spectrum. The spectrum length (NFFT) is computed over $[0,2\pi)$, or if <code>FS</code> is specified, $[0,FS)$. Entering <code>'onesided'</code> returns the one-sided mean-square spectrum, which contains the total signal power in half the Nyquist range. Default is <code>'onesided'</code>.</p> <p><code>Hmss = msspectrum(Hs,X,'NormalizedFrequency',true)</code> returns a mean-square spectrum object with frequency values normalized between 0 and 1. Default is <code>true</code>.</p> <p><code>Hmss = msspectrum(Hs,X,'Fs',Fs)</code> returns a mean-square spectrum object computed as a function of frequency, where <code>FS</code> is the sampling frequency in Hz. Note that you can set <code>FS</code> only if <code>NormalizedFrequency</code> is set to <code>false</code>.</p> <p><code>Hmss = msspectrum(...,'NFFT',nfft)</code> specifies the number of FFT points to use. Valid values are a positive integer, <code>'Nextpow2'</code> or <code>'Auto'</code>. <code>'Nextpow2'</code> uses the next power of 2 greater than the input length or 256, whichever is greater. <code>'Auto'</code> uses the input length or 256, whichever is greater. Default is <code>'Nextpow2'</code>. Note that for <code>spectrum.welch</code>, <code>'Nextpow2'</code> and <code>'Auto'</code> are compared to the <code>SegmentLength</code> instead of the input length.</p> <p><code>Hmss = msspectrum(...,'Centerdc', true)</code> shifts the data and frequency values so that the DC component is at the center of the spectrum. Default is <code>false</code>.</p>

Method	Description
	<p>To estimate the spectrum on a vector of specific frequencies, first set the number of frequency points to 'User Defined', which replaces the NFFT property of <code>msspectrum</code> with a <code>FrequencyVector</code> property.</p> <pre>Hopts.FreqPoints = 'User Defined'</pre> <p>(Note that the default for <code>FreqPoints</code> is 'All', which causes <code>msspectrum</code> to use the NFFT property as described above.)</p> <p>Then, specify the frequency vector <code>F</code> to use.</p> <pre>Hopts.FrequencyVector = F</pre> <p>(Note that the default value for <code>FrequencyVector</code> is 'Auto'. In this case, the number of frequency points used follows the same rule as described for NFFT 'Auto' above.)</p> <p><code>Hmms = msspectrum(..., 'ConfLevel', p)</code> specifies the confidence level <code>p</code> for computing the confidence interval, which is an estimate of the error in the calculated mean-squared spectrum. The confidence level (<code>p</code>) is between 0 and 1. For example, <code>Hmss = msspectrum(Hs,X, 'ConfLevel', 0.95)</code> returns the 95% confidence interval.</p>
psd	<p>Note that <code>music</code> and <code>eigenvector</code> spectrum objects do not support the <code>psd</code> method. See the <code>pseudospectrum</code> method below.</p> <p>The power spectral density (PSD) is intended for continuous spectra. The integral of the PSD over a given frequency band computes the average power in the signal in that frequency band. In contrast to the <code>msspectrum</code>, the peaks in this spectra do not reflect the power at a given frequency. The units of the PSD are power per unit of frequency. See the <code>avgpower</code> method of <code>dspdata</code> for more information.</p> <p><code>Hpsd = psd (Hs,X)</code> returns a power spectral density object containing the power spectral density estimate of the discrete-time signal <code>X</code> using the spectrum object <code>Hs</code>. The PSD is the distribution of power per unit frequency. Default for real <code>X</code> is 'onesided' and for complex <code>X</code> is 'twosided'.</p> <p><code>Hpsd</code> contains a vector of normalized frequencies <code>W</code>, at which the PSD is estimated. For real signals, the range of <code>W</code> is $[0,\pi]$ if the number of FFT points (NFFT) is even, and $[0,\pi)$ if NFFT is odd. For complex signals, the range of <code>W</code> is $[0,2\pi)$.</p>

Method	Description
	<p>The <code>psd</code> method includes these properties, which you can set using this <code>psd</code> method or via the <code>psdopts</code> method. These properties are listed here and described in the <code>psdopts</code> section below:</p> <p><code>SpectrumType</code> — 'onesided' or 'twosided'</p> <p><code>NormalizedFrequency</code> — normalizes frequency between 0 and 1</p> <p><code>Fs</code> — sampling frequency in Hz</p> <p><code>NFFT</code> — number of FFT points</p> <p><code>CenterDC</code> — shifts data and frequencies to center DC component</p> <p><code>FreqPoints</code> — 'All' or 'User Defined'</p> <p><code>FrequencyVector</code> — frequencies at which to compute spectrum</p> <p><code>ConfLevel</code> — confidence level to calculate the confidence interval. Value must be from 0 to 1.</p> <p>For example, <code>Hmss = psd(Hs,X,'FreqPoints','User Defined', FreqVector, fvect)</code> returns a PSD object where the spectrum is calculated only on the frequency points defined in the frequency vector, <code>fvect</code>.</p> <p><code>psd(...)</code> with no output arguments plots PSD in dB per unit frequency.</p>
psdopts	<p><code>Hopts = psdopts(Hs)</code> returns an object that contains options for the spectrum object <code>Hs</code>.</p> <p><code>Hopts = psdopts(Hs,X)</code> returns an object with data-specific options and defaults.</p> <p>You can pass an <code>Hopts</code> options object as an argument to the <code>psd</code> method. Any individual option you specify after the <code>Hopts</code> object overrides the value in <code>Hopts</code>. For example, <code>Hpsd = psd(Hs,X,Hopts,'SpectrumType','twosided')</code> overrides the <code>SpectrumType</code> value in <code>Hopts</code>.</p> <p>The following properties apply to both <code>psdmopts</code> and <code>psd</code> methods.</p> <p><code>Hpsd = psd(Hs,X,'SpectrumType','twosided')</code> returns the two-sided power spectral density of <code>X</code>. The spectrum length is <code>NFFT</code> and is computed over $[0,2\pi)$ if <code>Fs</code> is not specified or $[0,Fs)$ if <code>Fs</code> is specified. Entering 'onesided' returns the one-sided PSD, which contains the total signal power.</p>

Method	Description
	<p><code>Hmss = psd(Hs,X, 'NormalizedFrequency', true)</code> returns a power spectral density object with frequency values normalized between 0 and 1. Default is <code>true</code>.</p> <p><code>Hpsd = psd (... , 'Fs', Fs)</code> returns a power spectral density object computed as a function of frequency, where <code>Fs</code> is the sampling frequency in Hz.</p> <p><code>Hmss = psd(... , 'NFFT', nfft)</code> specifies the number of FFT points to use. Valid values are a positive integer, <code>'Nextpow2'</code> or <code>'Auto'</code>. <code>'Nextpow2'</code> uses the next power of 2 greater than the input length or 256, whichever is greater. <code>'Auto'</code> uses the input length or 256, whichever is greater. Default is <code>'Nextpow2'</code>. Note that for <code>spectrum.welch</code>, <code>'Nextpow2'</code> and <code>'Auto'</code> are compared to the <code>SegmentLength</code> instead of the input length.</p> <p><code>Hmss = psd (... , 'Centerdc', true)</code> shifts the data and frequency values so that the DC component is at the center of the spectrum. Default is <code>false</code>.</p> <p>To estimate the spectrum on a vector of specific frequencies, first set the number of frequency points to <code>'User Defined'</code>, which replaces the <code>NFFT</code> property of <code>psd</code> with a <code>FrequencyVector</code> property. <code>Hopts.FreqPoints = 'User Defined'</code> (Note that the default for <code>FreqPoints</code> is <code>'All'</code> which causes <code>psd</code> to use the <code>NFFT</code> property as described above.)</p> <p><code>Hmms = psd(... , 'ConfLevel', p)</code> specifies the confidence level <code>p</code> for computing the confidence interval, which is an estimate of the error in the calculated PSD. The confidence level (<code>p</code>) is between 0 and 1. For example, <code>Hmss = psd(Hs,X, 'ConfLevel', 0.95)</code> returns the 95% confidence interval.</p>
<p><code>pseudospectrum</code></p>	<p>Note that this method is used for only <code>music</code> or <code>eigenvector</code> spectrum objects.</p> <p><code>Hps = pseudospectrum(Hs,X)</code> returns an object containing the pseudospectrum estimate of the discrete-time signal <code>X</code> using the spectrum object <code>Hs</code>. <code>Hs</code> must be a <code>music</code> or <code>eigenvector</code> object. Default for real <code>X</code> is <code>'half'</code> and for complex <code>X</code> is the <code>'whole'</code> Nyquist frequency range.</p>

Method	Description
	<p>Hps contains a vector of normalized frequencies W, at which the pseudospectrum is estimated. For real signals, the range of W is $[0,\pi]$ if the number of FFT points (NFFT) is even, and $[0,\pi)$ if NFFT is odd. For complex signals, the range of W is $[0,2\pi)$.</p> <p>The <code>pseudospectrum</code> method includes these properties, which you can set using this <code>pseudospectrum</code> method or via the <code>pseudospectrumopts</code> method. These properties are described below:</p> <p><code>SpectrumRange</code> — 'half' or 'whole'</p> <p><code>NormalizedFrequency</code> — normalizes frequency between 0 and 1</p> <p><code>Fs</code> — sampling frequency in Hz</p> <p><code>NFFT</code> — number of FFT points</p> <p><code>CenterDC</code> — shifts data and frequencies to center DC component</p> <p><code>FreqPoints</code> — 'All' or 'User Defined'</p> <p><code>FrequencyVector</code> — frequencies at which to compute spectrum</p> <p>For example, <code>Hmss = psd(Hs,X,'FreqPoints','User Defined', FreqVector, fvect)</code> returns a PSD object where the spectrum is calculated only on the frequency points defined in the frequency vector, <code>fvect</code>.</p> <p><code>pseudospectrum(...)</code> with no output arguments plots the pseudospectrum in dB.</p>
pseudo-spectrumopts	<p><code>Hopts = pseudospectrumopts(Hs)</code> returns an object that contains options for the spectrum object Hs.</p> <p><code>Hopts = pseudospectrumopts(Hs,X)</code> returns an object with data-specific options and defaults. You can pass an <code>Hopts</code> options object as an argument to the <code>pseudospectrum</code> method. Any individual option you specify after the <code>Hopts</code> object overrides the value in <code>Hopts</code>. For example, <code>Hpspectrum = pseudospectrum(Hs,X, Hopts, 'SpectrumRange', 'whole')</code> overrides the <code>SpectrumRange</code> value in <code>Hopts</code>.</p> <p><code>Hmps = pseudospectrum(..., 'SpectrumRange', 'whole')</code> returns the pseudospectrum over the whole Nyquist range. The spectrum length is NFFT and is computed over $[0,2\pi)$ if <code>Fs</code> is not specified or $[0,Fs)$</p>

Method	Description
	<p>if <code>Fs</code> is specified. Entering <code>'half'</code> returns the pseudospectrum calculated over half the Nyquist range.</p> <p><code>Hmss = pseudospectrum(Hs,X,'NormalizedFrequency',true)</code> returns a pseudospectrum object with frequency values normalized between 0 and 1. Default is <code>true</code>.</p> <p><code>Hps = pseudospectrum(Hs,X,'Fs',Fs)</code> returns a pseudospectrum object computed as a function of frequency, where <code>Fs</code> is the sampling frequency in Hz.</p> <p><code>Hps = pseudospectrum(...,'NFFT',nfft)</code> specifies the number of FFT points to use. Valid values are a positive integer, <code>'Nextpow2'</code> or <code>'Auto'</code>. <code>'Nextpow2'</code> uses the next power of 2 greater than the input length or 256, whichever is greater. <code>'Auto'</code> uses the input length or 256, whichever is greater. Default is <code>'Nextpow2'</code>.</p> <p><code>Hps = pseudospectrum(...,'Centerdc',true)</code> shifts the data and frequency values so that the DC component is at the center of the spectrum. The default value is <code>false</code>.</p> <p>To estimate the spectrum on a vector of specific frequencies, first set the number of frequency points to <code>'User Defined'</code>, which replaces the <code>NFFT</code> property of <code>pseudospectrum</code> with a <code>FrequencyVector</code> property. <code>Hopts.FreqPoints = 'User Defined'</code> (Note that the default for <code>FreqPoints</code> is <code>'All'</code>, which causes <code>pseudospectrum</code> to use the <code>NFFT</code> property as described above.)</p>
powerest	<p>Note that <code>powerest</code> is available only for <code>music</code> and <code>eigenvector</code> spectrum objects.</p> <p><code>POW = powerest(Hs,X)</code> returns a vector <code>POW</code> containing estimates of the powers of the complex sinusoids in <code>X</code>. The input <code>X</code> can be a vector or a matrix. If it is a matrix it can be a data matrix, where $X^*X = R$ or a correlation matrix R. The value the <code>InputType</code> property of <code>Hs</code> determines how <code>X</code> is interpreted. <code>Hs</code> must be a <code>music</code> or <code>eigenvector</code> spectrum object.</p> <p><code>[POW,W]=powerest(Hs,X)</code> returns <code>POW</code> and a vector <code>W</code> of the frequencies in rad/sample of the sinusoids in <code>X</code>.</p>

Method	Description
	<code>[POW,F]=powerest(Hs,X,Fs)</code> returns POW and a vector F of the frequencies in Hz of the sinusoids in X. Fs is the sampling frequency.

Viewing Object Properties

As with any object, you can use `get` to view a `spectrum` object's properties. To see a specific property, use

```
get(Hs, 'property')
```

where `'property'` is the specific property name.

To see all properties for an object, use

```
get(Hs)
```

Changing Object Properties

To set specific properties, use

```
set(Hs, 'property1', value, 'property2', value, ...)
```

where `'property1'`, `'property2'`, etc. are the specific property names.

To view the options for a property use `set` without specifying a value

```
set(Hs, 'property')
```

Note that you must use single quotation marks around the property name. For example, to change the order of a Burg `spectrum` object `Hs` to 6, use

```
set(Hs, 'order', 6)
```

Another example of using `set` to change an object's properties is this example of changing the dynamically created window property of a periodogram `spectrum` object.

```
Hs=spectrum.periodogram      % Create periodogram object
```

```
Hs =
```

```
    EstimationMethod: 'Periodogram'
        WindowName: 'Rectangular'

set(Hs,'WindowName','Chebyshev')    % Change window type
Hs                                  % View changed object

Hs =

    EstimationMethod: 'Periodogram'
        WindowName: 'Chebyshev'    % Note changed property
        SidelobeAtten: 100

set(Hs,'SidelobeAtten',150)        % Change dynamic property
Hs                                  % View changed object

Hs =

    EstimationMethod: 'Periodogram'
        WindowName: 'Chebyshev'
        SidelobeAtten: 150
```

All spectrum object properties can be changed using the `set` command, except for the `EstimationMethod` property.

Another way to change an object's properties is by using the `inspect` command which opens the Property Inspector window where you can edit any property, except dynamic properties, such as those used with windows.

```
inspect(Hs)
```

Copying an Object

To create a copy of an object, use the `copy` method.

```
H2 = copy(Hs)
```

Note Using the syntax `H2 = HS` copies only the object handle and does not create a new object.

Examples

PSD via Periodogram

Generate a cosine of frequency 200 Hz sampled at 1 kHz for 300 ms. Add Gaussian white noise. View its power spectral density estimate generated with the `periodogram` algorithm.

```
Fs = 1000;  
t = 0:1/Fs:0.3;  
x = cos(2*pi*t*200) + randn(size(t));
```

```
Hs = spectrum.periodogram;  
psd(Hs,x, 'Fs',Fs)
```

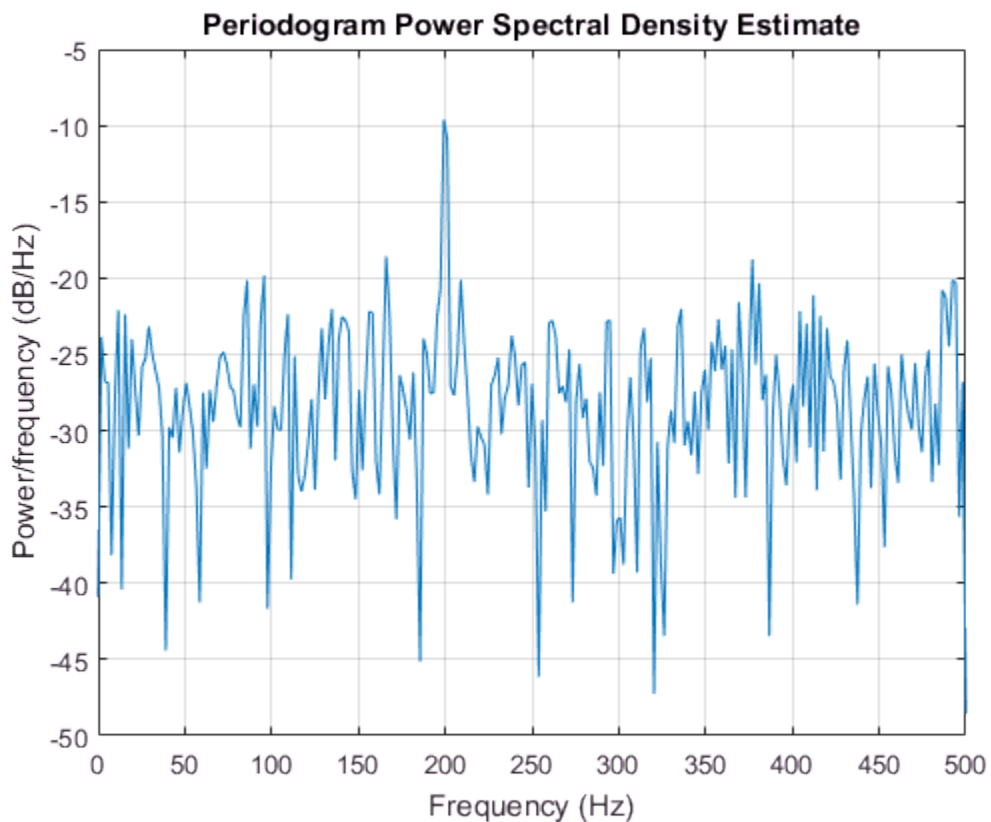

Refer to the reference pages for each estimation method for more examples.

Introduced before R2006a

spectrum.burg

Burg spectrum

Syntax

```
Hs = spectrum.burg  
Hs = spectrum.burg(order)
```

Description

Note: The use of `spectrum.burg` is not recommended. Use `pburg` instead.

`Hs = spectrum.burg` returns a default Burg spectrum object, `Hs`, that defines the parameters for the Burg parametric spectral estimation algorithm. The Burg algorithm estimates the spectral content by fitting an autoregressive (AR) linear prediction filter model of a given order to the signal.

`Hs = spectrum.burg(order)` returns a spectrum object, `Hs` with the specified order. The default value for `order` is 4.

Note See `pburg` for more information on the Burg algorithm.

Examples

Define a fourth order autoregressive model and view its power spectral density using the Burg algorithm.

```
x=randn(100,1);  
x=filter(1,[1 1/2 1/3 1/4 1/5],x); % 4th order AR filter  
Hs=spectrum.burg; % 4th order AR model  
psd(Hs,x,'NFFT',512)
```

See Also

`pburg` | `pcov` | `pmcov` | `pyulearn`

Introduced before R2006a

spectrum.cov

Covariance spectrum

Syntax

```
Hs = spectrum.cov  
Hs = spectrum.cov(order)
```

Description

Note: The use of `spectrum.cov` is not recommended. Use `pcov` instead.

`Hs = spectrum.cov` returns a default covariance spectrum object, `HS`, that defines the parameters for the covariance spectral estimation algorithm. The covariance algorithm estimates the spectral content by fitting an autoregressive (AR) linear prediction model of a given `order` to the signal.

`Hs = spectrum.cov(order)` returns a spectrum object, `HS` with the specified `order`. The default value for `order` is 4.

Note See `pcov` for more information on the covariance algorithm.

Examples

Define a fourth order autoregressive model and view its power spectral density using the covariance algorithm.

```
x=randn(100,1);  
x=filter(1,[1 1/2 1/3 1/4 1/5],x); % 4th order AR filter  
Hs=spectrum.cov; % 4th order AR model  
psd(Hs,x,'NFFT',512)
```

See Also

pburg | pcov | pmcov | pyulearn

Introduced before R2006a

spectrum.eigenvector

Eigenvector spectrum

Syntax

```
Hs = spectrum.eigenvector
Hs = spectrum.eigenvector(NSinusoids)
Hs = spectrum.eigenvector(NSinusoids,SegmentLength)
Hs = spectrum.eigenvector(NSinusoids,SegmentLength,...OverlapPercent)
Hs = spectrum.eigenvector(NSinusoids,SegmentLength,...OverlapPercent,WindowName)
Hs = spectrum.eigenvector(NSinusoids,SegmentLength,...OverlapPercent,WindowName)
Hs = spectrum.eigenvector(NSinusoids,SegmentLength,...OverlapPercent,WindowName)
```

Description

Note: The use of `spectrum.eigenvector` is not recommended. Use `peig` instead.

`Hs = spectrum.eigenvector` returns a default eigenvector spectrum object, `HS`, that defines the parameters for an eigenanalysis spectral estimation method. This object uses the following default values:

Default Values

Property Name	Default Value	Description
NSinusoids	2	Number of complex sinusoids
SegmentLength	4	Length of each of the time-based segments into which the input signal is divided.
OverlapPercent	50	Percent overlap between segments
WindowName	'Rectangular'	Window name or 'User Defined' (see <code>window</code> for valid window names). For more information on each window, refer to its reference page.

Property Name	Default Value	Description
		<p>This argument can also be a cell array containing the window name or 'User Defined' and, if used for the particular window, an optional parameter value. The syntax is {wname,wparam}.</p> <p>You can use <code>set</code> to change the value of the additional parameter or to define the MATLAB expression and parameters for a user-defined window (see <code>spectrum</code> for information on using <code>set</code>).</p>
SubspaceThreshold	0	<p>Threshold is the cutoff for signal and noise separation. The threshold is multiplied by λ_{\min}, the smallest estimated eigenvalue of the signal's correlation matrix. Eigenvalues below the threshold ($\lambda_{\min} * \text{threshold}$) are assigned to the noise subspace.</p>
InputType	'Vector'	<p>Type of input that will be used with this spectrum object. Valid values are 'Vector', 'DataMatrix' and 'CorrelationMatrix'.</p>

`Hs = spectrum.eigenvector(NSinusoids)` returns a spectrum object, `Hs`, with the specified number of sinusoids and default values for all other properties. Refer to the table above for default values.

`Hs = spectrum.eigenvector(NSinusoids,SegmentLength)` returns a spectrum object, `Hs`, with the specified segment length.

`Hs = spectrum.eigenvector(NSinusoids,SegmentLength,...OverlapPercent)` returns a spectrum object, `Hs`, with the specified overlap between segments.

`Hs = spectrum.eigenvector(NSinusoids,SegmentLength,...OverlapPercent,WindowName)` returns a spectrum object, `Hs`, with the specified window.

Note Window names must be enclosed in single quotes, such as `spectrum.eigenvector(3,32,50,'chebyshev')` or `spectrum.eigenvector(3,32,50,{'chebyshev',60})`.

`Hs = spectrum.eigenvector(NSinusoids,SegmentLength,...OverlapPercent,WindowName)`
returns a spectrum object, `Hs`, with the specified subspace threshold.

`Hs = spectrum.eigenvector(NSinusoids,SegmentLength,...OverlapPercent,WindowName)`
returns a spectrum object, `Hs`, with the specified input type.

Note See `peig` for more information on the eigenanalysis algorithm.

Examples

Define a complex signal with three sinusoids, add noise, and view its pseudospectrum using eigenanalysis. Set the FFT length to 128.

```
n=0:99;  
s=exp(i*pi/2*n)+2*exp(i*pi/4*n)+exp(i*pi/3*n)+randn(1,100);  
Hs=spectrum.eigenvector(3,32,95,'rectangular',5);  
pseudospectrum(Hs,s,'NFFT',128)
```

References

[1] Harris, F. J. "On the Use of Windows for Harmonic Analysis with the Discrete Fourier Transform." *Proceedings of the IEEE*. Vol. 66 (January 1978).

See Also

`peig` | `pmusic`

Introduced before R2006a

spectrum.mcov

Modified covariance spectrum

Syntax

```
Hs = spectrum.mcov  
Hs = spectrum.mcov(order)
```

Description

Note: The use of `spectrum.mcov` is not recommended. Use `pmcov` instead.

`Hs = spectrum.mcov` returns a default modified covariance spectrum object, `Hs`, that defines the parameters for the modified covariance spectral estimation algorithm. The modified covariance algorithm estimates the spectral content by fitting an autoregressive (AR) linear prediction filter model of a given order to the signal.

`Hs = spectrum.mcov(order)` returns a spectrum object, `Hs` with the specified order. The default value for `order` is 4.

Note See `pmcov` for more information on the modified covariance algorithm.

Examples

Define a fourth order autoregressive model and view its power spectral density using the modified covariance algorithm.

```
x=randn(100,1);  
x=filter(1,[1 1/2 1/3 1/4 1/5],x); % 4th order AR filter  
Hs=spectrum.mcov; % 4th order AR model  
psd(Hs,x,'NFFT',512)
```

See Also

pburg | pcov | pmcov | pyulear

Introduced before R2006a

spectrum.mtm

Thomson multitaper spectrum

Syntax

```
Hs = spectrum.mtm
Hs = spectrum.mtm(TimeBW)
Hs = spectrum.mtm(DPSS,Concentrations)
Hs = spectrum.mtm(...,CombineMethod)
```

Description

Note: The use of `spectrum.mtm` is not recommended. Use `pmtm` instead.

`Hs = spectrum.mtm` returns a default Thomson multitaper spectrum object, `HS` that defines the parameters for the Thomson multitaper spectral estimation algorithm, which uses a linear or nonlinear combination of modified periodograms. The periodograms are computed using a sequence of orthogonal tapers (windows in the frequency domain) specified from discrete prolate spheroidal sequences (`dpss`). This object uses the following default values:

Property Name	Default Value	Description
TimeBW	4	Product of time and bandwidth for the discrete prolate spheroidal sequences (or Slepian sequences) used as data windows
CombineMethod	'adaptive'	Algorithm for combining the individual spectral estimates. Valid values are 'adaptive' — adaptive (nonlinear) 'unity' — unity weights (linear) 'eigenvector' — Eigenvalue weights (linear)

`Hs = spectrum.mtm(TimeBW)` returns a spectrum object, `HS` with the specified time-bandwidth product.

`Hs = spectrum.mtm(DPSS,Concentrations)` returns a spectrum object, `Hs` with the specified dpss data tapers and their concentrations.

Note You can either specify the time-bandwidth product (`TimeBW`) or the DPSS data tapers and their `Concentrations`. See `dpss` and `pmtm` for more information.

`Hs = spectrum.mtm(...,CombineMethod)` returns a spectrum object, `Hs`, with the specified method for combining the spectral estimates. Refer to the table above for valid `CombineMethod` values.

Examples

Define a cosine of 200 Hz, add noise and view its power spectral density using the Thomson multitaper algorithm with a time-bandwidth product of 3.5.

```
Fs=1000;  
t=0:1/Fs:.3;  
x=cos(2*pi*t*200)+randn(size(t));  
Hs=spectrum.mtm(3.5);  
psd(Hs,x,'Fs',Fs)
```

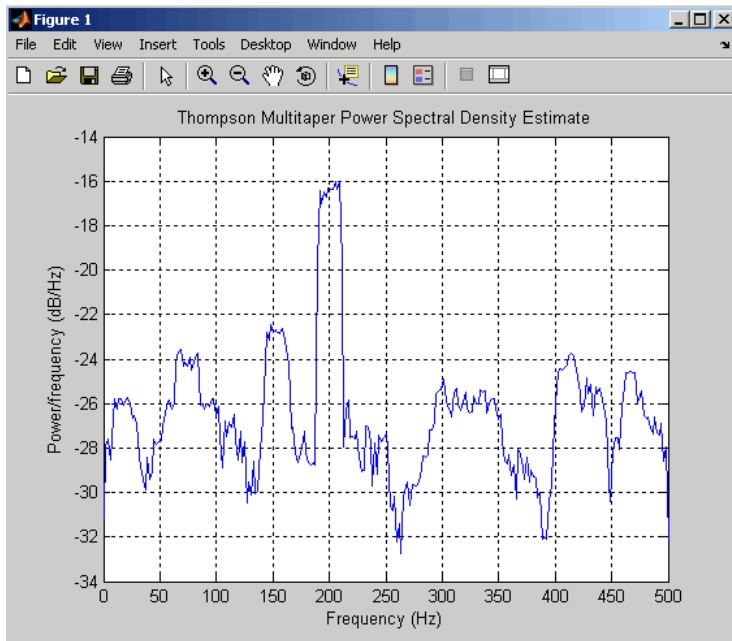

The above example could be done by specifying the data tapers and concentrations instead of the time-bandwidth product.

```
Fs=1000;
t=0:1/Fs:.3;
x=cos(2*pi*t*200)+randn(size(t));
[e,v]=dpss(length(x),3.5);
Hs=spectrum.mtm(e,v);
psd(Hs,x,'Fs',Fs)
```

See Also

periodogram | pmtm | pwelch

Introduced before R2006a

spectrum.music

Multiple signal classification spectrum

Syntax

```
Hs = spectrum.music
Hs = spectrum.music(NSinusoids)
Hs = spectrum.music(NSinusoids,SegmentLength)
Hs = spectrum.music(NSinusoids,SegmentLength,...OverlapPercent)
Hs = spectrum.music(NSinusoids,SegmentLength,...OverlapPercent,WindowName)
Hs = spectrum.music(NSinusoids,SegmentLength,...OverlapPercent,WindowName,Subs)
Hs = spectrum.music(NSinusoids,SegmentLength,...OverlapPercent,WindowName,Subs)
```

Description

Note: The use of `spectrum.music` is not recommended. Use `pmusic` instead.

`Hs = spectrum.music` returns a default multiple signal classification (MUSIC) spectrum object, `HS`, that defines the parameters for the MUSIC spectral estimation algorithm, which uses Schmidt's eigenspace analysis algorithm. This object uses the following default values.

Default Values

Property Name	Default Value	Description
<code>NSinusoids</code>	2	Number of complex sinusoids
<code>SegmentLength</code>	4	Length of each of the time-based segments into which the input signal is divided.
<code>OverlapPercent</code>	50	Percent overlap between segments
<code>WindowName</code>	'Rectangular'	Window name or 'User Defined' (see <code>window</code> for valid window names). For more information on

Property Name	Default Value	Description
		<p>each window, refer to its reference page).</p> <p>This argument can also be a cell array containing the window name or 'User Defined' and, if used for the particular window, an optional parameter value. The syntax is {wname ,wparam}.</p> <p>You can use <code>set</code> to change the value of the additional parameter or to define the MATLAB expression and parameters for a user-defined window (see <code>spectrum</code> for information on using <code>set</code>).</p>
SubspaceThreshold	0	<p>Threshold is the cutoff for signal and noise separation. The threshold is multiplied by λ_{\min}, the smallest estimated eigenvalue of the signal's correlation matrix. Eigenvalues below the threshold ($\lambda_{\min} * \text{threshold}$) are assigned to the noise subspace.</p>
InputType	'Vector'	<p>Type of input that will be used with this spectrum object. Valid values are 'Vector', 'DataMatrix' and 'CorrelationMatrix'.</p>

`Hs = spectrum.music(NSinusoids)` returns a spectrum object, `HS`, with the specified number of sinusoids and default values for all other properties. Refer to the table above for default values.

`Hs = spectrum.music(NSinusoids,SegmentLength)` returns a spectrum object, `HS`, with the specified segment length.

`Hs = spectrum.music(NSinusoids,SegmentLength,...OverlapPercent)` returns a spectrum object, `HS`, with the specified overlap between segments.

`Hs = spectrum.music(NSinusoids,SegmentLength,...OverlapPercent,WindowName)`
returns a spectrum object, `Hs`, with the specified window.

Note Window names must be enclosed in single quotes, such as `spectrum.music(3,32,50,'chebyshev')` or `spectrum.music(3,32,50,{'chebyshev',60})`

`Hs = spectrum.music(NSinusoids,SegmentLength,...OverlapPercent,WindowName,Subs`
returns a spectrum object, `HS`, with the specified subspace threshold.

`Hs = spectrum.music(NSinusoids,SegmentLength,...OverlapPercent,WindowName,Subs`
returns a spectrum object, `HS`, with the specified input type.

Note See `pmusic` for more information on the MUSIC algorithm.

Examples

MUSIC Pseudospectrum of a Sinusoidal Signal

Define a complex signal with three sinusoids, add noise, and estimate its pseudospectrum using the MUSIC algorithm.

```
n = 0:99;  
s = exp(1i*pi/2*n) + 2*exp(1i*pi/4*n) + exp(1i*pi/3*n) + randn(1,100);  
  
Hs = spectrum.music(3,20);  
  
pseudospectrum(Hs,s)
```

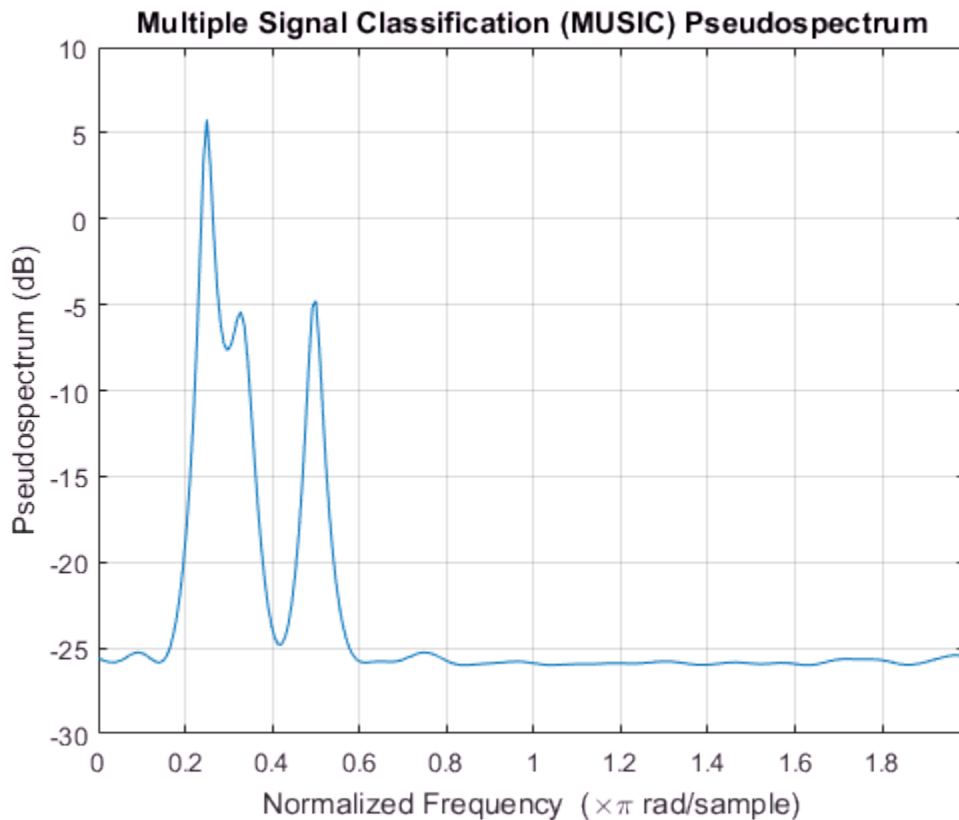

References

- [1] Harris, Fredric. J. “On the Use of Windows for Harmonic Analysis with the Discrete Fourier Transform.” *Proceedings of the IEEE*. Vol. 66, January 1978, pp.51–83.

See Also

peig | pmusic

Introduced before R2006a

spectrum.periodogram

Periodogram spectrum

Syntax

```
Hs = spectrum.periodogram
Hs = spectrum.periodogram(winname)
Hs = spectrum.periodogram({windowname,winparameter})
```

Description

Note: The use of `spectrum.periodogram` is not recommended. Use `periodogram` instead.

`Hs = spectrum.periodogram` returns a default periodogram spectrum object, `HS`, that defines the parameters for the periodogram spectral estimation method. This default object uses a rectangular window and a default FFT length equal to the next power of 2 (`NextPow2`) that is greater than the input length.

`Hs = spectrum.periodogram(winname)` returns a spectrum object, `HS`, that uses the specified window. If the window uses an optional associated window parameter, it is set to the default value. This object uses the default FFT length.

`Hs = spectrum.periodogram({windowname,winparameter})` returns a spectrum object, `HS`, that uses the specified window and optional associated window parameter, if any. You specify the window and window parameter in a cell array with the window name and the parameter value. This object uses the default FFT length.

Valid window names are:

```
'Bartlett'
'Bartlett-Hann'
'Blackman'
'Blackman-Harris'
```

```
'Bohman'  
'Chebyshev'  
'Flat Top'  
'Gaussian'  
'Hamming'  
'Hann'  
'Kaiser'  
'Nuttall'  
'Parzen'  
'Rectangular'  
'Triangular'  
'Tukey'  
'User Defined'
```

See `window` and the corresponding window function page for window parameter information.

You can use `set` to change the value of the additional parameter or to define the MATLAB expression and parameters for a user-defined window (see `spectrum` for information on using `set`).

Note Window names must be enclosed in single quotes, such as `spectrum.periodogram('Tukey')` or `spectrum.periodogram({'Tukey',0.7})`.

Note See `periodogram` for more information on the periodogram algorithm.

Examples

Periodogram Spectral Estimate of Sinusoid

Define a cosine of 200 Hz sampled at 1 kHz. Add noise and view the spectral content of the signal using the periodogram spectral estimation technique with default values.

```
Fs = 1000;  
t = 0:1/Fs:.3;  
x = cos(2*pi*t*200)+randn(size(t));  
Hs = spectrum.periodogram;  
psd(Hs,x,'Fs',Fs)
```

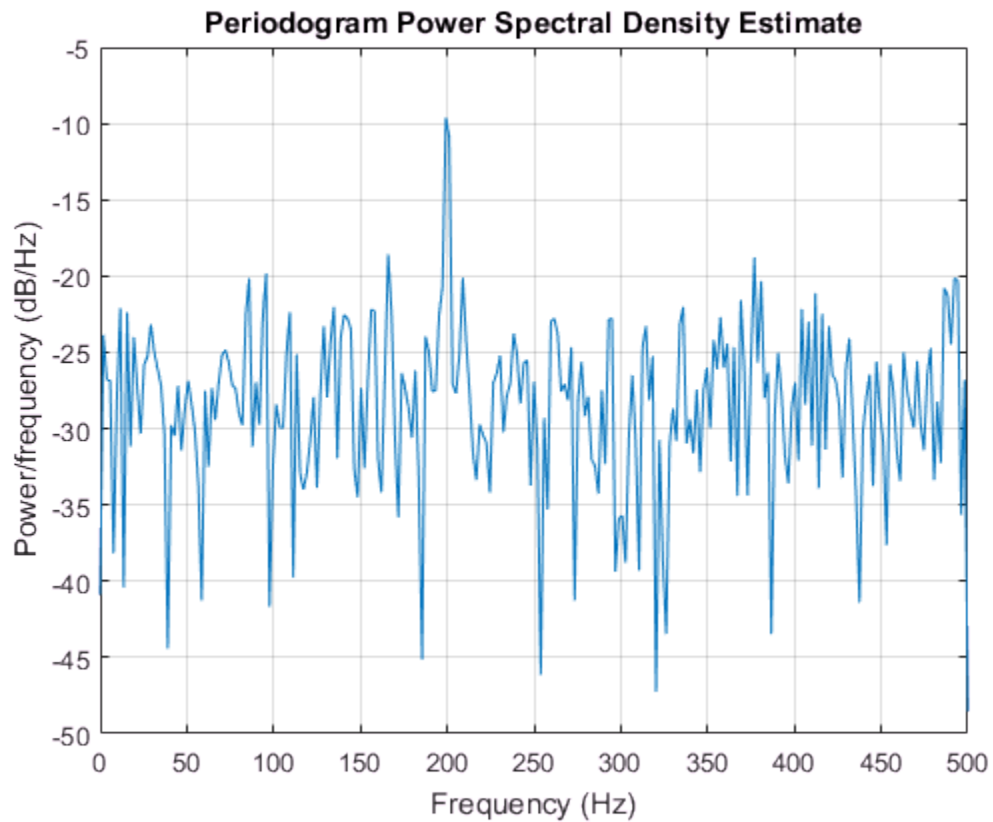
References

- [1] harris, fredric j. "On the Use of Windows for Harmonic Analysis with the Discrete Fourier Transform." *Proceedings of the IEEE*. Vol. 66, January 1978, pp.51–83.

See Also

See Also

periodogram | pmtm | pwelch

Introduced before R2006a

spectrum.welch

Welch spectrum

Syntax

```
Hs = spectrum.welch
Hs = spectrum.welch(WindowName)
Hs = spectrum.welch(WindowName,SegmentLength)
Hs = spectrum.welch(WindowName,SegmentLength,OverlapPercent)
```

Description

Note: The use of `spectrum.welch` is not recommended. Use `pwelch` instead.

`Hs = spectrum.welch` returns a default Welch spectrum object, `HS`, that defines the parameters for Welch's averaged, modified periodogram spectral estimation method. The object uses these default values.

Property Name	Default Value	Description
{WindowName,winparameter Cell array containing WindowName and optional window parameter	'Hamming', SamplingFlag: symmetric	Cell array containing the window name or 'User Defined' and, if used for the particular window, an optional parameter value. (See window for valid window names and for more information on each window, refer to its reference page.) You can use <code>set</code> to change the value of the additional parameter or to define the MATLAB expression and parameters for a user-defined window. (See

Property Name	Default Value	Description
		spectrum for information on using set.)
WindowName	'Hamming', SamplingFlag: symmetric	<p>Valid windowname options are:</p> <ul style="list-style-type: none"> 'Bartlett' 'Bartlett-Hann' 'Blackman' 'Blackman-Harris' 'Bohman' 'Chebyshev' 'Flat Top' 'Gaussian' 'Hamming' 'Hann' 'Kaiser' 'Nuttall' 'Parzen' 'Rectangular' 'Triangular' 'Tukey' 'User Defined' <p>Window names must be enclosed in single quotes, such as <code>spectrum.welch('tukey')</code> or <code>spectrum.welch({'tukey',0.7})</code>.</p> <p>See <code>window</code> and the corresponding window function page for window parameter information. You can use <code>set</code> to change the value of the additional window parameter or to define the MATLAB expression and parameters for a user-defined window (see <code>spectrum</code> for information on using <code>set</code>).</p>

Property Name	Default Value	Description
SegmentLength	64	Length of each of the time-based segments into which the input signal is divided. A modified periodogram is computed on each segment and the average of the periodograms forms the spectral estimate. Choosing the segment length is a compromise between estimate reliability (shorter segments) and frequency resolution (longer segments). A long segment length produces better resolution while a short segment length produces more averages, and therefore a decrease in the variance.
OverlapPercent	50%	Percent overlap between segments

`Hs = spectrum.welch(WindowName)` returns a spectrum object, `Hs`, using Welch's method with the specified window and the default values for all other parameters. To specify parameters for a window, use a cell array formatted as `spectrum.welch({WindowName,winparam})`.

`Hs = spectrum.welch(WindowName,SegmentLength)` returns a spectrum object, `Hs` with the specified segment length.

`Hs = spectrum.welch(WindowName,SegmentLength,OverlapPercent)` returns a spectrum object, `Hs` with the specified percentage overlap between segments.

Note See `pwelch` for more information on the Welch algorithm.

Examples

Spectral Content of Sinusoid

Define a cosine of 200 Hz embedded in white noise.

```
Fs = 1000;  
t = 0:1/Fs:.3;  
x = cos(2*pi*t*200)+randn(size(t));
```

View the spectral content of the signal using the Welch algorithm.

```
Hs = spectrum.welch;  
psd(Hs,x, 'Fs',Fs)
```

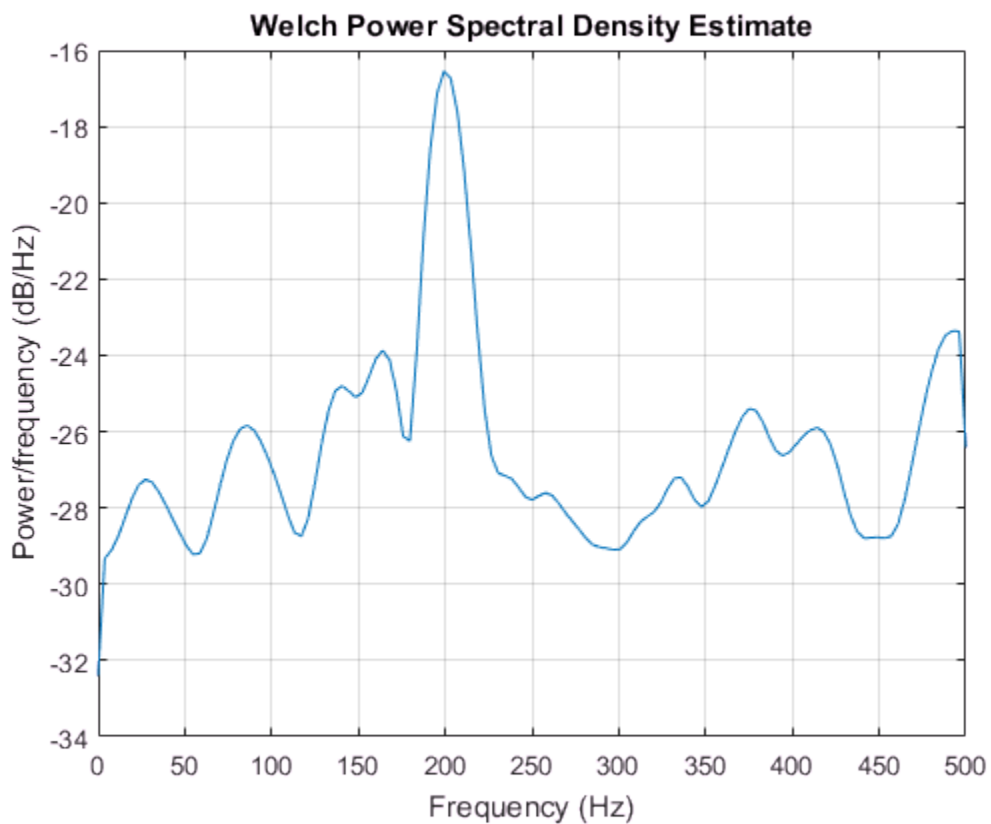

PSD Estimate Using Hann Window

Define a cosine of 200 Hz embedded in white noise.

```
Fs = 1000;  
t = 0:1/Fs:0.3;  
x = cos(2*pi*t*200)+randn(size(t));
```

Compute Welch's power spectral density estimate of the signal using a Hann window.

```
window = 33;  
noverlap = 32;  
nfft = 4097;  
  
h = spectrum.welch('Hann',window,100*noverlap/window);  
hpsd = psd(h,x,'NFFT',nfft,'Fs',Fs);
```

Visualize the power spectral density expressed in decibels.

```
Pw = hpsd.Data;  
Fw = hpsd.Frequencies;  
plot(Fw,pow2db(Pw))  
xlabel('Hz')  
ylabel('dB')
```

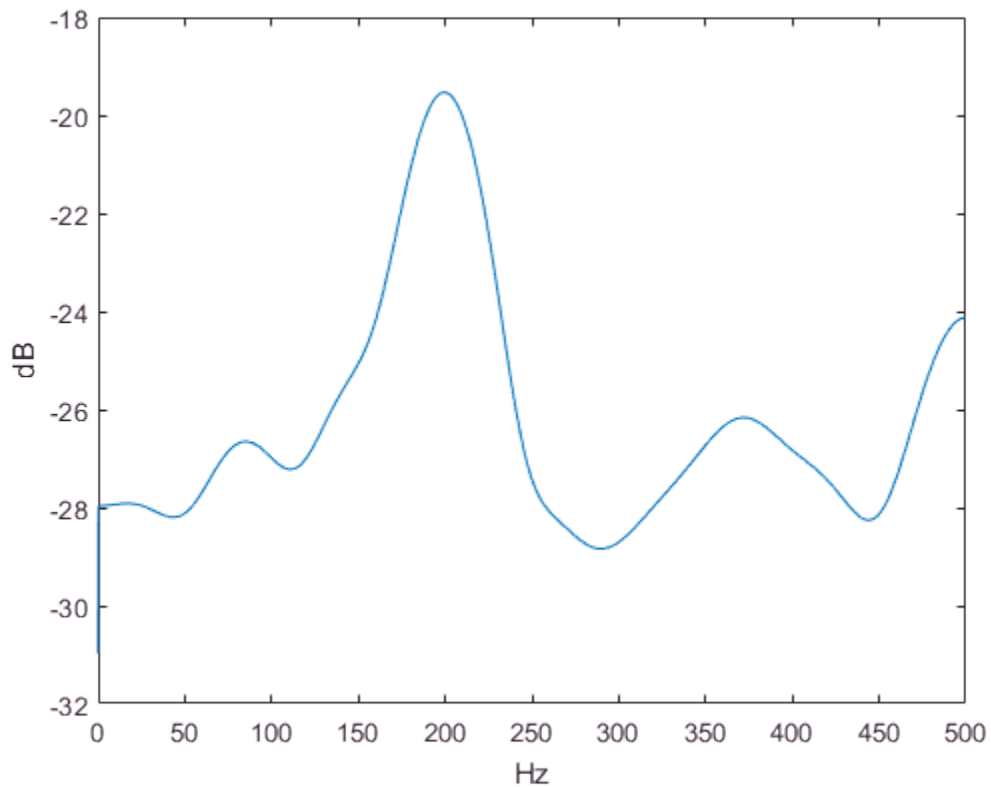

References

- [1] harris, fredric. j. “On the Use of Windows for Harmonic Analysis with the Discrete Fourier Transform.” *Proceedings of the IEEE*. Vol. 66 (January 1978).

See Also

See Also

periodogram | pmtm | pwelch

Introduced before R2006a

spectrum.yulear

Yule-Walker spectrum object

Syntax

```
Hs = spectrum.yulear  
Hs = spectrum.yulear(order)
```

Description

Note: The use of `spectrum.yulear` is not recommended. Use `pyulear` instead.

`Hs = spectrum.yulear` returns a default Yule-Walker spectrum object, `HS`, that defines the parameters for the Yule-Walker spectral estimation algorithm. This method is also called the auto-correlation or windowed method. The Yule-Walker algorithm estimates the spectral content by fitting an autoregressive (AR) linear prediction filter model of a given `order` to the signal. This leads to a set of Yule-Walker equations, which are solved using Levinson-Durbin recursion.

`Hs = spectrum.yulear(order)` returns a spectrum object, `HS`, with the specified `order`. The default value for `order` is 4.

Note See `pyulear` for more information on the Yule-Walker algorithm.

Examples

Define a fourth order autoregressive model and view its spectral content using the Yule-Walker algorithm.

```
x=randn(100,1);  
x=filter(1,[1 1/2 1/3 1/4 1/5],x); % 4th order AR filter  
Hs=spectrum.yulear; % 4th order AR model  
psd(Hs,x,'NFFT',512)
```

See Also

pburg | pcov | pmcov | pyulearn

Introduced before R2006a

sptool

Open interactive digital signal processing tool

Syntax

`sptool`

Description

The command, `sptool`, opens SPTool, a suite of four tools: Signal Browser, Filter Design and Analysis Tool, FVTool, and Spectrum Viewer. These tools provide access to many of the signal, filter, and spectral analysis functions in the toolbox. When you type `sptool` at the command line, the SPTool suite opens.

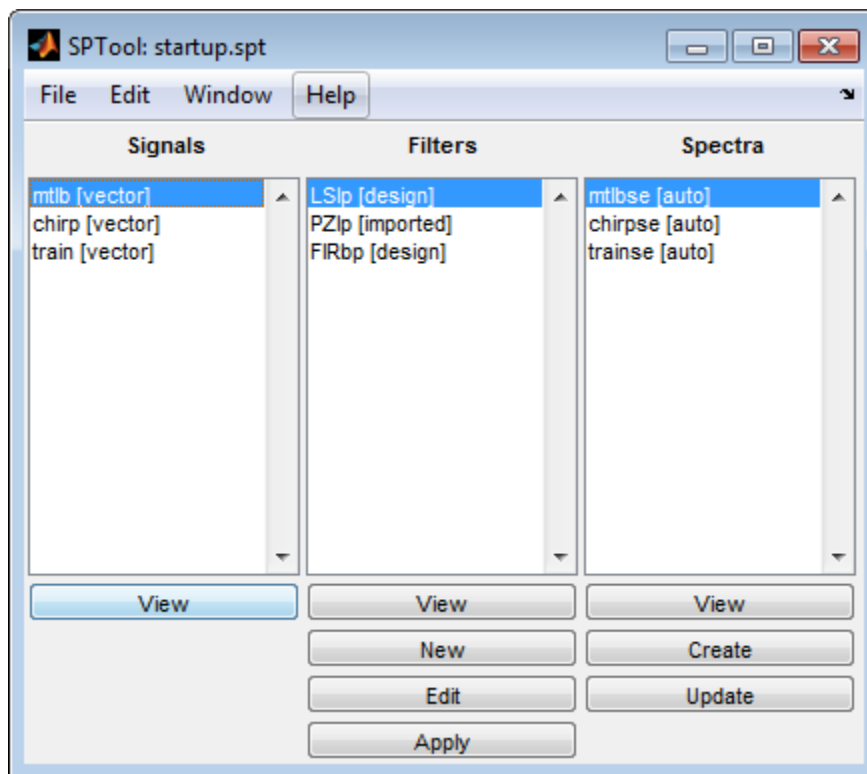

Using SPTool, you can:

- Analyze signals listed in the **Signals** list box with the Signal Browser.
- Design or edit filters with the Filter Design and Analysis Tool (includes a Pole/Zero Editor).
- Analyze filter responses for filters listed in the **Filters** list box with FVTool.
- Apply filters in the **Filters** list box to signals in the **Signals** list box.
- Create and analyze signal spectra with the Spectrum Viewer.
- Print the Signal Browser, Filter Design and Analysis Tool, and Spectrum Viewer.

You can activate all four integrated signal processing tools from SPTool.

- “Signal Browser” on page 1-2256
- “Filter Designer App” on page 1-2290

- “Filter Visualization Tool” on page 1-2291
- “Spectrum Viewer” on page 1-2291

Signal Browser

The Signal Browser, hereafter referred to as the scope, allows you to view, measure, and analyze the time-domain information of one or more signals. To activate the Signal Browser, press the **View** button under the **Signals** list box in SPTool.

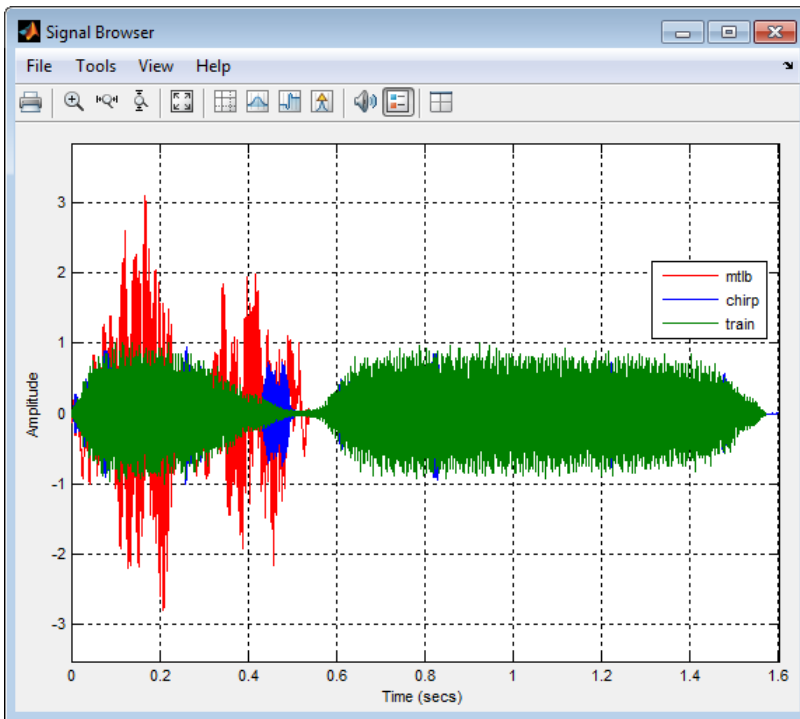

See the following sections for more information on the Signal Browser:

- “Displaying Multiple Signals” on page 1-2257
- “Signal Display” on page 1-2259
- “Toolbar” on page 1-2261

- “Measurements Panels” on page 1-2266
- “Visuals — Time Domain Options” on page 1-2281
- “Style Dialog Box” on page 1-2287

Displaying Multiple Signals

Multiple Signal Input

Select more than one signal in the **Signals** list box to show multiple signals within the same display or on separate displays. By default, the signals appear as different-colored lines on the same display. The signals can have different dimensions, sample rates, and data types. Each signal can be either real or complex valued.

Multiple Signal Colors

By default, Signal Browser has a white axes background and chooses line colors for each channel in a manner similar to the MATLAB `plot` function. Signal Browser considers each of the real and imaginary components of the input signals to be a channel, and assigns each channel a line color in the following order:

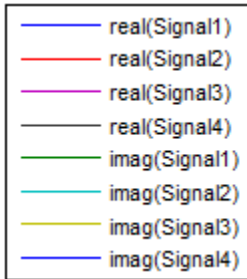

- 1 Blue
- 2 Dark Green
- 3 Red
- 4 Cyan
- 5 Purple
- 6 Dark Yellow
- 7 Black

If there are more than 7 channels, the scope repeats this order to assign line colors to the remaining channels. For example, if you select 4 complex-valued input signals, the following legend appears in the display.

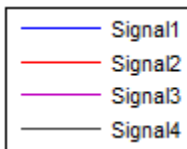

If all the input signals are real-valued, Signal Browser skips the line colors that would be associated with their imaginary components. For example, if you select 4 real-valued input signals, the following legend appears in the display.



To manually modify any line color, select **View > Style** to open the Style dialog box. Next to **Properties for line**, select the signal name whose color you want to change. Then, next to **Line**, click the Line color button () and select any color from the palette. To change the axes background color, click the Axes background color button () and select any color from the palette.

Use Multiple Displays

You can display multiple channels of data on different displays in the scope window. In the scope toolbar, select **View > Layout**, or select the Layout button ()

Note: The **Layout** menu item and button are not available when the scope is in snapshot mode.

You can tile the window into multiple displays. For example, if there are three inputs to the scope, you can display the signals in three separate displays. The layout grid shows a

4 by 4 grid, but you can select up to 16 by 16 by clicking and dragging within the layout grid.

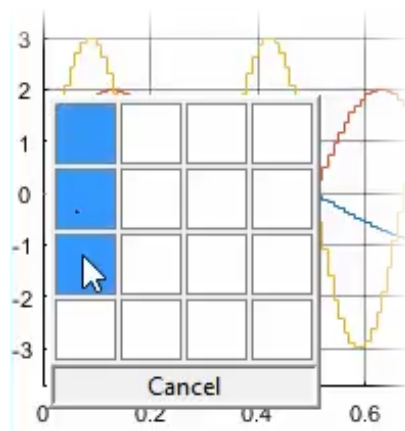

When you use the Layout option to tile the window into multiple displays, the display highlighted in blue is referred to as the *active display*. The scope dialog boxes reference the active display.

Signal Display

The Signal Browser uses the longest time length of all the input signals selected in the **Signals** list box for the time range. To communicate the array of times that corresponds to the current display, the scope uses the **Minimum time-axis limit**, **Time units**, and **Maximum time-axis limit** indicators on the scope window. The following figure highlights these aspects of the Signal Browser window.

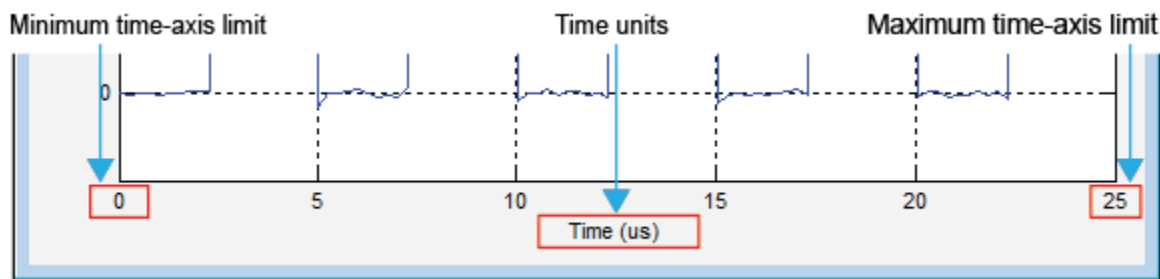

- **Minimum time-axis limit** — The Signal Browser sets the minimum *time*-axis limit to 0.
- **Maximum time-axis limit** — The Signal Browser sets the maximum *time*-axis limit to the final time step of the longest input signal.
- **Time units** — The units used to describe the *time*-axis. The Signal Browser sets the time units using the value of the **Time Units** parameter on the **Main** tab of the Visuals:Time Domain Options dialog box. By default, this parameter is set to **Metric (based on Time Span)** and displays in metric units such as microseconds, milliseconds, minutes, days, etc. You can change the unit of measure to **Seconds** to always display the *time*-axis values in units of seconds. You can change it to **None** to suppress the display of units of measure on the *time*-axis. When you set this parameter to **None**, then the Signal Browser shows only the word **Time** on the *time*-axis.

To hide both the word **Time** and the values on the *time*-axis, set the **Show time-axis labels** parameter to **None**. To hide both the word **Time** and the values on the *time*-axis in all displays except the bottom ones in each column of displays, set this parameter to **Bottom Displays Only**. This behavior differs from that of the Simulink Scope block, which always shows the values but never shows a label on the *x*-axis.

Signal Names and Legend Text

Signal Browser uses the names of the signals in the SPTool as the text displayed in the legends. If you change the name of any selected signal in the **Signals** list box, its corresponding legend entry in Signal Browser changes immediately. To change the name of any selected signal, from the SPTool menu select **Edit > Name**. Signal Browser automatically updates the legend to reflect the new signal name you entered. Similarly, if you modify any entry in a legend in Signal Browser, then SPTool updates the corresponding signal name in the **Signals** list box.

Axes Maximization

You can specify whether to display the Signal Browser in maximized axes mode. In this mode, the axes are expanded to fill the entire display. In each display, there is no space to show titles or axis labels. The minimum and maximum *time*-axis limits are located at the far-left and far-right edges of the display. The values at the axis tick marks appear as grid lines on top of the axes. The following figure highlights how three displays appear in maximized axes mode in the Signal Browser window.

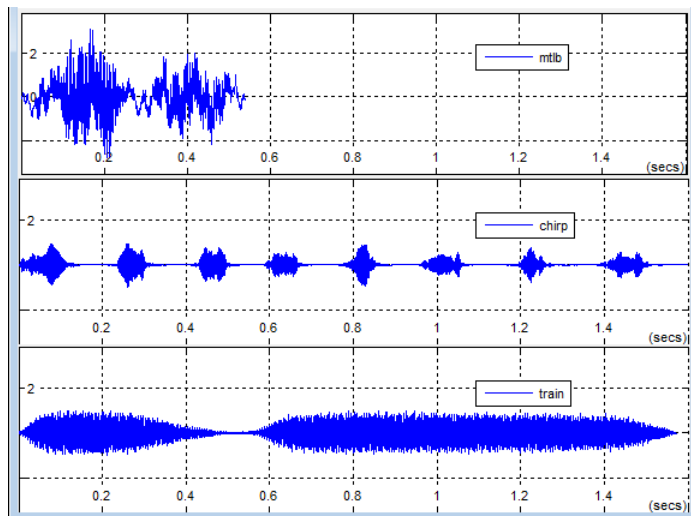

To enable or disable this mode, in the Signal Browser menu, select **View > Properties** to bring up the Visuals:Time Domain Options dialog box. In the **Main** pane, you can set the **Maximize axes** parameter to one of the following options:

- **Auto** — In this mode, the axes appear maximized in all displays only if the **Title** and **Y-Axis label** parameters are empty for every display. If you enter any value in any display for either of these parameters, the axes are not maximized.
- **On** — In this mode, the axes appear maximized in all displays. Any values entered into the **Title** and **Y-Axis label** parameters are hidden.
- **Off** — In this mode, none of the axes appear maximized.

See the “Visuals — Time Domain Options” on page 1-2281 section for more information.





Toolbar

The Signal Browser toolbar contains the following buttons.

Print Button

Button	Menu Location	Shortcut Keys	Description
	File > Print	Ctrl+P	Print the current scope window. To print the current scope window to a figure rather than sending it to your printer, select File > Print to figure .



Zoom and Axes Control Buttons



Button	Menu Location	Shortcut Keys	Description
	Tools > Zoom In	N/A	When this tool is active, you can zoom in on the scope window. To do so, click in the center of your area of interest, or click and drag your cursor to draw a rectangular area of interest inside the scope window.
	Tools > Zoom X	N/A	You access the Zoom X button from the menu under the Zoom In icon. When this tool is active, you can zoom in on the <i>x</i> -axis. To do so, click inside the scope window, or click and drag your cursor along the <i>x</i> -axis over your area of interest.
	Tools > Zoom Y	N/A	You access the Zoom Y button from the menu under the Zoom In icon. When this tool is active, you can zoom in on the <i>y</i> -axis. To do so, click inside the scope window, or click and drag your cursor along the <i>y</i> -axis over your area of interest.
	Tools > Pan	N/A	You access the Pan button from the menu under the Zoom In icon. When this tool is active, you can pan on the scope window. To do so, click in the center of your area of interest and drag your cursor to the left, right, up, or down, to move the position of the display.
	Tools > Scale Y-Axis Limits	Ctrl+A	Click this button to scale the axes in the active scope window.

Button	Menu Location	Shortcut Keys	Description
			<p>Alternatively, you can enable automatic axes scaling by selecting one of the following options from the Tools menu:</p> <ul style="list-style-type: none"> • Automatically Scale Axes Limits — When you select this option, the scope scales the axes as needed during simulation. • Scale Axes Limits after 10 Updates — When you select this option, the scope scales the axes after 10 updates. The scope does not scale the axes again during the simulation. • Scale Axes Limits at Stop — When you select this option, the scope scales the axes each time the simulation is stopped.
	Tools > Scale X-Axis Limits	N/A	<p>You access the Scale X-Axis Limits button from the menu under the current Axis Limits icon. Click this button to scale the axes in the X direction in the active scope window.</p> <p>Alternatively, you can enable automatic axes scaling by selecting one of the following options from the Tools menu:</p> <ul style="list-style-type: none"> • Automatically Scale Axes Limits — When you select this option, the scope scales the axes as needed during simulation. • Scale Axes Limits after 10 Updates — When you select this option, the scope scales the axes after 10 updates. The scope does not scale the axes again during the simulation. • Scale Axes Limits at Stop — When you select this option, the scope scales the axes each time the simulation is stopped.



Button	Menu Location	Shortcut Keys	Description
	Tools > Scale X & Y Axes Limits	N/A	<p>You access the Scale X & Y Axes Limits button from the menu under the current Axis Limits icon. Click this button to scale the axes in both the X and Y directions in the active scope window.</p> <p>Alternatively, you can enable automatic axes scaling by selecting one of the following options from the Tools menu:</p> <ul style="list-style-type: none"> • Automatically Scale Axes Limits — When you select this option, the scope scales the axes as needed during simulation. • Scale Axes Limits after 10 Updates — When you select this option, the scope scales the axes after 10 updates. The scope does not scale the axes again during the simulation. • Scale Axes Limits at Stop — When you select this option, the scope scales the axes each time the simulation is stopped.

Measurements Buttons

	Tools > Measurements > Cursor Measurements	N/A	<p>Open or close the Cursor Measurements panel. This panel puts screen cursors on all the displays.</p> <p>See the “Cursor Measurements Panel” on page 1-2267 section for more information.</p>
	Tools > Measurements > Signal Statistics	N/A	<p>Open or close the Signal Statistics panel. This panel displays the maximum, minimum, peak-to-peak difference, mean, median, RMS values of a selected signal, and the times at which the maximum and minimum occur.</p> <p>See the “Signal Statistics Panel” on page 1-2269 section for more information.</p>

	Tools > Measurements > Bilevel Measurements	N/A	<p>Open or close the Bilevel Measurements panel. This panel displays information about a selected signal's transitions, overshoots or undershoots, and cycles.</p> <p>See the “Bilevel Measurements Panel” on page 1-2270 section for more information.</p>
	Tools > Measurements > Peak Finder	N/A	<p>Open or close the Peak Finder panel. This panel displays maxima and the times at which they occur, allowing the settings for peak threshold, maximum number of peaks, and peak excursion to be modified.</p> <p>See the “Peak Finder Panel” on page 1-2279 section for more information.</p>

Other Buttons

	Tools > Play Selected Signal	N/A	Play an audio signal. The function <code>soundsc</code> is used to play the signal.
	View > Show All Legends	N/A	Show a legend that matches each line style to a signal name in every display.
	View > Layout	N/A	Arrange the layout of displays in the Signal Browser. This feature allows you to tile your screen into a number of separate displays, up to a grid of 4 rows and 4 columns. You may find multiple displays useful when you select multiple input signals in SPTool. The default display is 1 row and 1 column. See the section for more information.











You can control whether this toolbar appears in the Signal Browser window. From the Signal Browser menu, select **View > Toolbar**.



Measurements Panels

The Measurements panels are the five panels that appear at the right side of the Signal Browser. These panels are labeled **Trace selection**, **Cursor measurements**, **Signal statistics**, **Bilevel measurements**, and **Peak finder**.

Measurements Panel Buttons

Each of the Measurements panels contains the following buttons that enable you to modify the appearance of the current panel.

Button	Description
	Move the current panel to the top. When you are displaying more than one panel, this action moves the current panel above all the other panels.
	Collapse the current panel. When you first enable a panel, by default, it displays one or more of its panes. Click this button to hide all of its panes to conserve space. After you click this button, it becomes the expand button  .
	Expand the current panel. This button appears after you click the collapse button to hide the panes in the current panel. Click this button to display the panes in the current panel and show measurements again. After you click this button, it becomes the collapse button  again.
	Undock the current panel. This button lets you move the current panel into a separate window that can be relocated anywhere on your screen. After you click this button, it becomes the dock button  in the new window.
	Dock the current panel. This button appears only after you click the undock button. Click this button to put the current panel back into the right side of the Scope window. After you click this button, it becomes the undock button  again.
	Close the current panel. This button lets you remove the current panel from the right side of the Scope window.

Some panels have their measurements separated by category into a number of panes. Click the pane expand button  to show each pane that is hidden in the current panel. Click the pane collapse button  to hide each pane that is shown in the current panel.

Trace Selection Panel

When you use the scope to view multiple signals, the Trace Selection panel appears if you have more than one signal displayed and you click any of the other Measurements panels. The Measurements panels display information about only the signal chosen in this panel. Choose the signal name for which you would like to display time domain measurements. See the following figure.

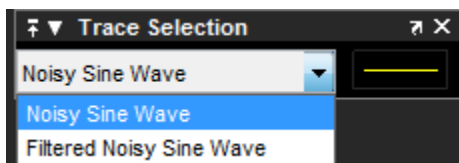

You can choose to hide or display the **Trace Selection** panel. In the Scope menu, select **Tools > Measurements > Trace Selection**.

Cursor Measurements Panel

The **Cursor Measurements** panel displays screen cursors. The panel provides two types of cursors for measuring signals. Waveform cursors are vertical cursors that track along the signal. Screen cursors are both horizontal and vertical cursors that you can place anywhere in the display.

Note: If a data point in your signal has more than one value, the cursor measurement at that point is undefined and no cursor value is displayed.

In the Scope menu, select **Tools > Measurements > Cursor Measurements**.

Alternatively, in the Scope toolbar, click the Cursor Measurements  button.

The **Settings** pane enables you to modify the type of screen cursors used for calculating measurements. When more than one signal is displayed, you can assign cursors to each trace individually.

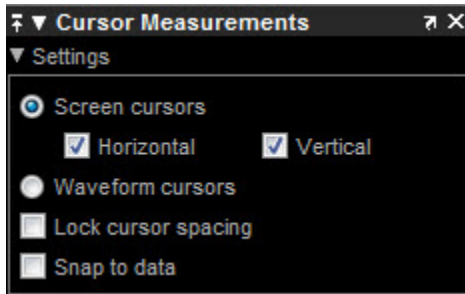

- **Screen Cursors** — Shows screen cursors.
- **Horizontal** — Shows horizontal screen cursors.
- **Vertical** — Shows vertical screen cursors.
- **Waveform Cursors** — Shows cursors that attach to the input signals.
- **Lock Cursor Spacing** — Locks the frequency difference between the two cursors.
- **Snap to Data** — Positions the cursors on signal data points.

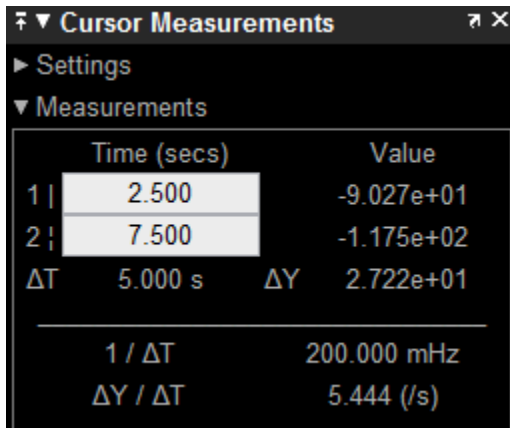

You can use the mouse or the left and right arrow keys to move vertical or waveform cursors and the up and down arrow keys for horizontal cursors.

The **Measurements** pane shows the time and value measurements.

- **1 |** — Shows or enables you to modify the time or value at cursor number one, or both.

- **2** :— Shows or enables you to modify the time or value at cursor number two, or both.
- **Δt** — Shows the absolute value of the difference in the times between cursor number one and cursor number two.
- **ΔV** — Shows the absolute value of the difference in signal amplitudes between cursor number one and cursor number two.
- **$1/\Delta t$** — Shows the rate, the reciprocal of the absolute value of the difference in the times between cursor number one and cursor number two.
- **$\Delta V/\Delta t$** — Shows the slope, the ratio of the absolute value of the difference in signal amplitudes between cursors to the absolute value of the difference in the times between cursors.

Signal Statistics Panel

Note: The **Signal Statistics** panel requires a DSP System Toolbox or Simscape™ license.

The **Signal Statistics** panel displays the maximum, minimum, peak-to-peak difference, mean, median, and RMS values of a selected signal. It also shows the x -axis indices at which the maximum and minimum values occur. In the Scope menu, select **Tools > Measurements > Signal Statistics**. Alternatively, in the scope toolbar, click the Signal Statistics  button.

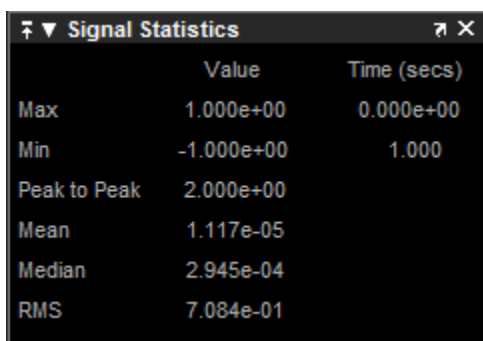

	Value	Time (secs)
Max	1.000e+00	0.000e+00
Min	-1.000e+00	1.000
Peak to Peak	2.000e+00	
Mean	1.117e-05	
Median	2.945e-04	
RMS	7.084e-01	

The statistics shown are:

- **Max** — The maximum or largest value within the displayed portion of the input signal. For more information on the algorithm this measurement uses, see the MATLAB `max` function reference.
- **Min** — The minimum or smallest value within the displayed portion of the input signal. For more information on the algorithm this measurement uses, see the MATLAB `min` function reference.
- **Peak to Peak** — The difference between the maximum and minimum values within the displayed portion of the input signal. For more information on the algorithm this measurement uses, see the Signal Processing Toolbox `peak2peak` function reference.
- **Mean** — The average or mean of all the values within the displayed portion of the input signal. For more information on the algorithm this measurement uses, see the MATLAB `mean` function reference.
- **Median** — The median value within the displayed portion of the input signal. For more information on the algorithm this measurement uses, see the MATLAB `median` function reference.
- **RMS** — Shows the difference between the maximum and minimum values within the displayed portion of the input signal. For more information on the algorithm this measurement uses, see the Signal Processing Toolbox `rms` function reference.

When you use the zoom options in the Scope, the Signal Statistics measurements automatically adjust to the time range shown in the display. For example, you can zoom in on one pulse to make the **Signal Statistics** panel display information about only that particular pulse.

The Signal Statistics measurements are valid for any units of the input signal. The letter after the value associated with each measurement represents the appropriate International System of Units (SI) prefix, such as *m* for *milli-*. For example, if the input signal is measured in volts, an *m* next to a measurement value indicates that this value is in units of millivolts.

Bilevel Measurements Panel

Note: The **Bilevel Measurements** panel requires a DSP System Toolbox or Simscape license.

The **Bilevel Measurements** panel shows information about transitions, overshoots, undershoots, and cycles for a selected signal. You can choose to hide or display the

Bilevel Measurements panel. In the scope menu, select **Tools > Measurements > Bilevel Measurements**. Alternatively, in the scope toolbar, you can select the Bilevel Measurements  button.

When you use the zoom options in the Scope, the bilevel measurements automatically adjust to the time range shown in the display. For example, you can zoom in on one rising edge to make the **Bilevel Measurements** panel display information about only that particular rising edge. This feature does not apply to the **High** and **Low** measurements.

Bilevel Measurements	
▶ Settings	
▼ Transitions	
High	9.900e-01
Low	-9.900e-01
Amplitude	1.980e+00
+ Edges	1459
+ Rise Time	258.516 μ s
+ Slew Rate	8.296 (/ms)
- Edges	1459
- Fall Time	257.387 μ s
- Slew Rate	-8.309 (/ms)
▼ Overshoots / Undershoots	
+ Preshoot	-0.243 %
+ Overshoot	-0.271 %
+ Undershoot	24.163 %
+ Settling Time	--
- Preshoot	-0.250 %
- Overshoot	24.424 %
- Undershoot	-0.276 %
- Settling Time	--
▼ Cycles	
Period	1.739 ms
Frequency	575.040 Hz
+ Pulses	1458
+ Width	867.458 μ s
+ Duty Cycle	49.647 %
- Pulses	1459
- Width	873.184 μ s
- Duty Cycle	50.290 %

The **Bilevel Measurements** panel is separated into four panes, labeled **Settings**, **Transitions**, **Overshoots/Undershoots**, and **Cycles**. You can expand each pane to see the available options.

Bilevel Measurements Plot

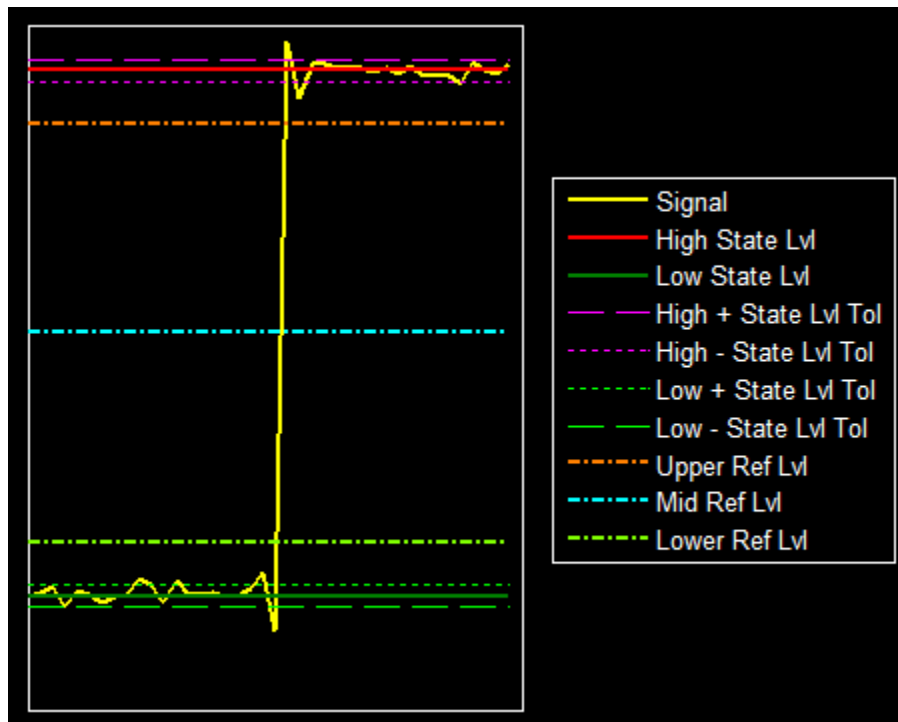

Note: Opening the **Overshoots/Undershoots** pane may reduce the number of available edges by 1 if the last edge of the pulse is not within the **Settle Seek** time of the end of the plot. This reduction in the number of edges changes the values of **Edges**, **Fall Time**, and **Slew Rate** in the **Transitions** pane.

The **Settings** pane enables you to modify the properties used to calculate various measurements involving transitions, overshoots, undershoots, and cycles. You can modify the high-state level, low-state level, state-level tolerance, upper-reference level, mid-reference level, and lower-reference level, as shown in the following figure.

- **Auto State Level** — When this check box is selected, the Bilevel measurements panel autodetects the high- and low- state levels of a bilevel waveform. For more information on the algorithm this option uses, see the Signal Processing Toolbox `statelevels` function reference. When this check box is cleared, you can enter in values for the high- and low- state levels manually.
 - **High** — Manually specify the value for a positive polarity or high-state level.
 - **Low** — Manually specify the value for a negative polarity or low-state level.
- **State Level Tolerance** — Tolerance within which the initial and final levels of each transition must be within their respective state levels. This value is expressed as a percentage of the difference between the high- and low-state levels.
- **Upper Ref Level** — Used to compute the end of the rise-time measurement or the start of the fall time measurement. This value is expressed as a percentage of the difference between the high- and low-state levels.
- **Mid Ref Level** — Used to determine when a transition occurs. This value is expressed as a percentage of the difference between the high- and low- state levels. The mid-reference level is shown as a horizontal line, and its corresponding mid-reference level instant is shown as a vertical line.
- **Lower Ref Level** — Used to compute the end of the fall-time measurement or the start of the rise-time measurement. This value is expressed as a percentage of the difference between the high- and low-state levels.
- **Settle Seek** — The duration after the mid-reference level instant when each transition occurs used for computing a valid settling time. This value is equivalent to the input parameter, `D`, which you can set when you run the `settlingtime` function. The settling time is displayed in the **Overshoots/Undershoots** pane.

The **Transitions** pane displays calculated measurements associated with the input signal changing between its two possible state level values, high and low. The Transition measurements assume that the amplitude of the input signal is in units of volts. Convert all input signals to volts for the Transition measurements to be valid.

A positive-going transition, or *rising edge*, in a bilevel waveform is a transition from the low-state level to the high-state level. A positive-going transition has a slope value greater than zero. Whenever there is a plus sign (+) next to a text label, this symbol refers to measurement associated with a rising edge, a transition from a low-state level to a high-state level.

A negative-going transition, or *falling edge*, in a bilevel waveform is a transition from the high-state level to the low-state level. A negative-going transition has a slope value less

than zero. Whenever there is a minus sign (–) next to a text label, this symbol refers to measurement associated with a falling edge, a transition from a high-state level to a low-state level.

- **High** — The high-amplitude state level of the input signal over the duration of the **Time Span** parameter. You can set **Time Span** in the **Main** or **Time** tab of the Visuals—Time Domain Properties dialog box. For more information on the algorithm this measurement uses, see the Signal Processing Toolbox `statelevels` function reference.
- **Low** — The low-amplitude state level of the input signal over the duration of the **Time Span** parameter. You can set **Time Span** in the **Main** or **Time** tab of the Visuals—Time Domain Properties dialog box. The tab in which **Time Span** appears depends on whether you launched the scope from a from a MATLAB System object or from a Simulink block, respectively. For more information on the algorithm this measurement uses, see the Signal Processing Toolbox `statelevels` function reference.
- **Amplitude** — Difference in amplitude between the high-state level and the low-state level.
- **+ Edges** — Total number of positive-polarity, or rising, edges counted within the displayed portion of the input signal.
- **+ Rise Time** — Average amount of time required for each rising edge to cross from the lower-reference level to the upper-reference level. For more information on the algorithm this measurement uses, see the Signal Processing Toolbox `risetime` function reference.
- **+ Slew Rate** — Average slope of each rising-edge transition line within the upper- and lower-percent reference levels in the displayed portion of the input signal. The region in which the slew rate is calculated appears in gray.

For more information on the algorithm this measurement uses, see the Signal Processing Toolbox `slewrates` function reference.

- **– Edges** — Total number of negative-polarity or falling edges counted within the displayed portion of the input signal.
- **– Fall Time** — Average amount of time required for each falling edge to cross from the upper-reference level to the lower-reference level. For more information on the algorithm this measurement uses, see the Signal Processing Toolbox `falltime` function reference.
- **– Slew Rate** — Average slope of each falling edge transition line within the upper- and lower-percent reference levels in the displayed portion of the input signal. For

more information on the algorithm this measurement uses, see the Signal Processing Toolbox `slewrates` function reference.

The **Overshoots/Undershoots** pane displays calculated measurements involving the distortion and damping of the input signal. *Overshoot* and *undershoot* refer to the amount that a signal, respectively, exceeds and falls below its final steady-state value. *Preshoot* refers to the amount before a transition that a signal varies from its initial steady-state value. This figure shows preshoot, overshoot, and undershoot for a rising-edge transition.

Overshoot/Undershoot Plot

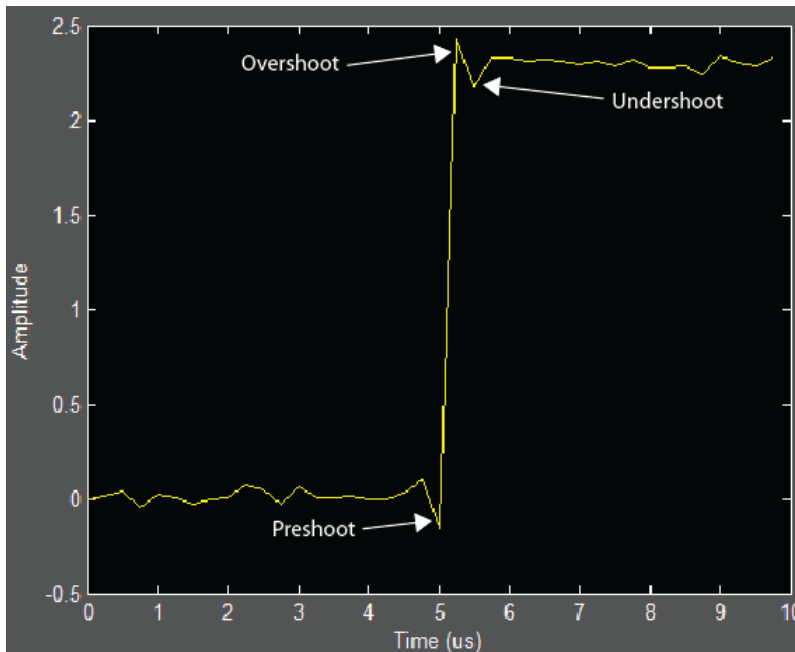

- + *Preshoot* — Average lowest aberration in the region immediately preceding each rising transition.
- + *Overshoot* — Average highest aberration in the region immediately following each rising transition. For more information on the algorithm this measurement uses, see the Signal Processing Toolbox `overshoot` function reference.
- + *Undershoot* — Average lowest aberration in the region immediately following each rising transition. For more information on the algorithm this measurement uses, see the Signal Processing Toolbox `undershoot` function reference.

- + *Settling Time* — Average time required for each rising edge to enter and remain within the tolerance of the high-state level for the remainder of the settle seek duration. The settling time is the time after the mid-reference level instant when the signal crosses into and remains in the tolerance region around the high-state level. This crossing is illustrated in the following figure.

Settling Time Plot

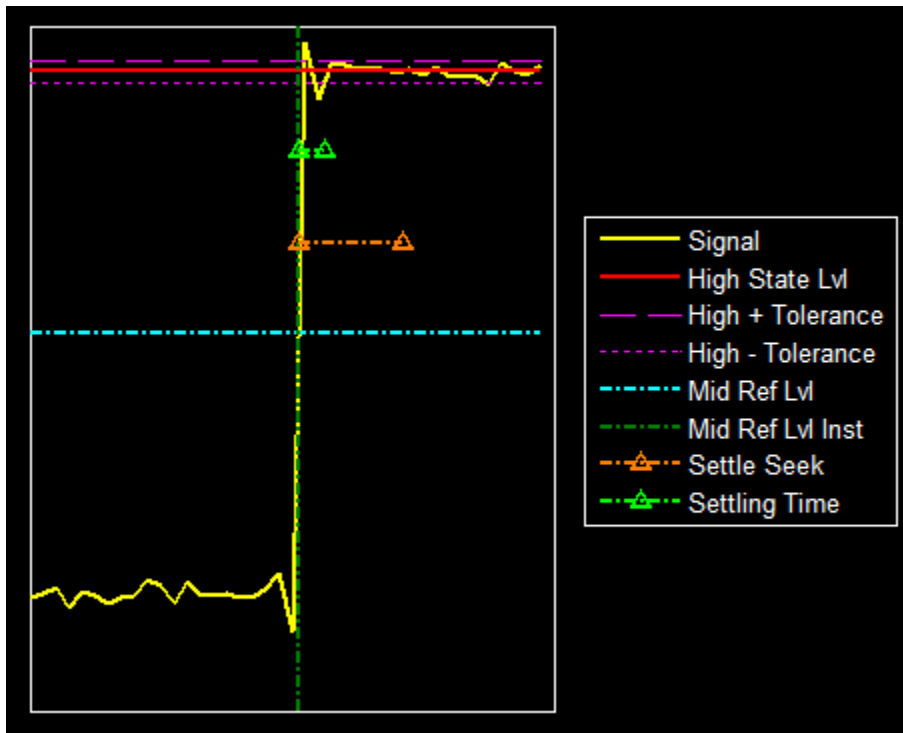

You can modify the settle seek duration parameter in the **Settings** pane. For more information on the algorithm this measurement uses, see the Signal Processing Toolbox `settlingtime` function reference.

- – *Preshoot* — Average highest aberration in the region immediately preceding each falling transition.

- – *Overshoot* — Average highest aberration in the region immediately following each falling transition. For more information on the algorithm this measurement uses, see the Signal Processing Toolbox `overshoot` function reference.
- – *Undershoot* — Average lowest aberration in the region immediately following each falling transition. For more information on the algorithm this measurement uses, see the Signal Processing Toolbox `undershoot` function reference.
- – *Settling Time* — Average time required for each falling edge to enter and remain within the tolerance of the low-state level for the remainder of the settle seek duration. The settling time is the time after the mid-reference level instant when the signal crosses into and remains in the tolerance region around the low-state level. You can modify the settle seek duration parameter in the **Settings** pane. For more information on the algorithm this measurement uses, see the Signal Processing Toolbox `settlingtime` function reference.

The **Cycles** pane displays calculated measurements of to repetitions or trends in the displayed portion of the input signal.

- **Period** — Average duration between adjacent edges of identical polarity within the displayed portion of the input signal. The Bilevel measurements panel calculates period as follows. It takes the difference between the mid-reference level instants of the initial transition of each positive-polarity pulse and the next positive-going transition. These mid-reference level instants appear as red dots.

For more information on the algorithm this measurement uses, see the Signal Processing Toolbox `pulseperiod` function reference.

- **Frequency** — Reciprocal of the average period. Whereas period is typically measured in some metric form of seconds, or seconds per cycle, frequency is typically measured in hertz or cycles per second.
- **+ Pulses** — Number of positive-polarity pulses counted.
- **+ Width** — Average duration between rising and falling edges of each positive-polarity pulse within the displayed portion of the input signal. For more information on the algorithm this measurement uses, see the Signal Processing Toolbox `pulsewidth` function reference.
- **+ Duty Cycle** — Average ratio of pulse width to pulse period for each positive-polarity pulse within the displayed portion of the input signal. For more information on the algorithm this measurement uses, see the Signal Processing Toolbox `dutycycle` function reference.
- **– Pulses** — Number of negative-polarity pulses counted.

- – **Width** — Average duration between rising and falling edges of each negative-polarity pulse within the displayed portion of the input signal. For more information on the algorithm this measurement uses, see the Signal Processing Toolbox `pulsewidth` function reference.
- – **Duty Cycle** — Average ratio of pulse width to pulse period for each negative-polarity pulse within the displayed portion of the input signal. For more information on the algorithm this measurement uses, see the Signal Processing Toolbox `dutycycle` function reference.

Peak Finder Panel

The **Peak Finder** panel displays the maxima, showing the x -axis values at which they occur. Peaks are defined as a local maximum where lower values are present on both sides of a peak. Endpoints are not considered to be peaks. This panel allows you to modify the settings for peak threshold, maximum number of peaks, and peak excursion. You can choose to hide or display the **Peak Finder** panel. In the scope menu, select **Tools > Measurements > Peak Finder**. Alternatively, in the scope toolbar, select the Peak Finder  button.

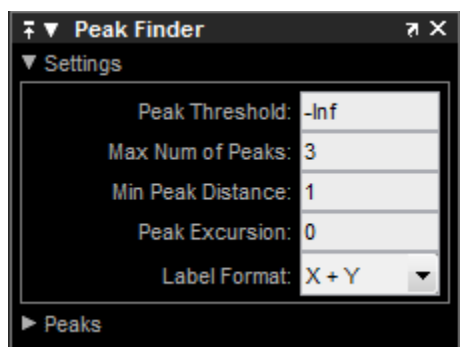

The **Peak finder** panel is separated into two panes, labeled **Settings** and **Peaks**. You can expand each pane to see the available options.

The **Settings** pane enables you to modify the parameters used to calculate the peak values within the displayed portion of the input signal. For more information on the algorithms this pane uses, see the Signal Processing Toolbox `findpeaks` function reference.

- **Peak Threshold** — The level above which peaks are detected. This setting is equivalent to the `MINPEAKHEIGHT` parameter, which you can set when you run the `findpeaks` function.
- **Max Num of Peaks** — The maximum number of peaks to show. The value you enter must be a scalar integer from 1 through 99. This setting is equivalent to the `NPEAKS` parameter, which you can set when you run the `findpeaks` function.
- **Min Peaks Distance** — The minimum number of samples between adjacent peaks. This setting is equivalent to the `MINPEAKDISTANCE` parameter, which you can set when you run the `findpeaks` function.
- **Peak Excursion** — The minimum height difference between a peak and its neighboring samples. The peak excursion setting is equivalent to the `THRESHOLD` parameter, which you can set when you run the `findpeaks` function.
- **Label Format** — The coordinates to display next to the calculated peak values on the plot. To see peak values, expand the **Peaks** pane and select the check boxes associated with individual peaks of interest. By default, both *x*-axis and *y*-axis values are displayed on the plot. Select which axes values you want to display next to each peak symbol on the display.
 - X+Y — Display both *x*-axis and *y*-axis values.
 - X — Display only *x*-axis values.
 - Y — Display only *y*-axis values.



The **Peaks** pane displays all of the largest calculated peak values. It also shows the coordinates at which the peaks occur, using the parameters you define in the **Settings** pane. You set the **Max Num of Peaks** parameter to specify the number of peaks shown in the list.

The screenshot shows a software interface titled "Peaks" with a dropdown arrow. Below the title is a table with two columns: "Value" and "Time (secs)". Each row in the table has a small square checkbox to its left. The values in the "Value" column are in scientific notation, and the values in the "Time (secs)" column are decimal numbers.

	Value	Time (secs)
<input type="checkbox"/>	3.944e+02	0.789
<input type="checkbox"/>	3.746e+02	0.769
<input type="checkbox"/>	3.414e+02	7.865

The numerical values displayed in the **Value** column are equivalent to the `pks` output argument returned when you run the `findpeaks` function. The numerical values

displayed in the second column are similar to the `locs` output argument returned when you run the `findpeaks` function.

The Peak Finder displays the peak values in the **Peaks** pane. By default, the **Peak Finder** panel displays the largest calculated peak values in the **Peaks** pane in decreasing order of peak height. Use the sort descending button () to rearrange the category and order by which Peak Finder displays peak values. Click this button again to sort the peaks in ascending order instead. When you do so, the arrow changes direction to become the sort ascending button (). A filled sort button indicates that the peak values are currently sorted in the direction of the button arrow. If the sort button is not filled () , then the peak values are sorted in the opposite direction of the button arrow. The **Max Num of Peaks** parameter still controls the number of peaks listed.

Use the check boxes to control which peak values are shown on the display. By default, all check boxes are cleared and the **Peak Finder** panel hides all the peak values. To show all the peak values on the display, select the check box in the top-left corner of the **Peaks** pane. To hide all the peak values on the display, clear this check box. To show an individual peak, select the check box directly to the left of its **Value** listing. To hide an individual peak, clear the check box directly to the left of its **Value** listing.

The Peaks are valid for any units of the input signal. The letter after the value associated with each measurement indicates the abbreviation for the appropriate International System of Units (SI) prefix, such as *m* for *milli-*. For example, if the input signal is measured in volts, an *m* next to a measurement value indicates that this value is in units of millivolts.

Visuals — Time Domain Options

The Visuals — Time Domain Properties dialog box controls the visual configuration settings of the Signal Browser display. From the menu, select **View > Configuration Properties** to open this dialog box.

Main Pane

The **Main** pane of the Visuals — Time Domain Properties dialog box appears as follows.

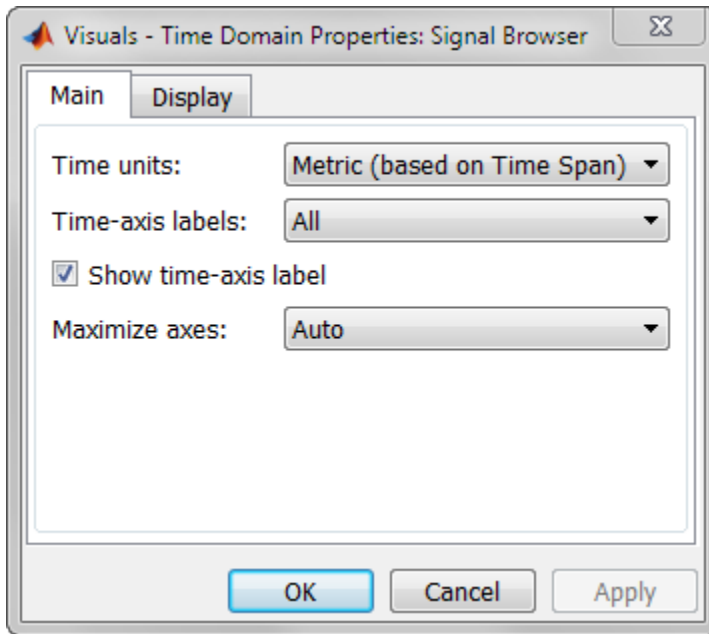

Time units

Specify the units used to describe the *time*-axis. The default setting is **Metric**. You can select one of the following options.

- **Metric** — In this mode, the Signal Browser converts the times on the *time*-axis to some metric units such as milliseconds, microseconds, days, etc. The Signal Browser chooses the appropriate metric units, based on the minimum *time*-axis limit and the maximum *time*-axis limit of the window.
- **Seconds** — In this mode, the Signal Browser always displays the units on the *time*-axis as seconds.
- **None** — In this mode, the Signal Browser displays no units on the *time*-axis. The Signal Browser shows only the word **Time** on the *time*-axis.

Time-axis labels

Specify how to display the time units used to describe the *time*-axis. The default setting is **All**. You can select one of the following options.

- **All** — In this mode, the *time*-axis labels appear in all displays.

- **None** — In this mode, the *time*-axis labels do not appear in the displays.
- **Bottom Displays Only** — In this mode, the *time*-axis labels appear only in the bottom row of the displays.

Show time-axis label

Select to turn on *time*-axis label display.

Maximize axes

Specify whether to display the Signal Browser in maximized axes mode. In this mode, each of the axes is expanded to fit into the entire display. In each display, there is no space to show labels. Tick mark values are shown on top of the plotted data. The default setting is **Auto**. You can select one of the following options:

- **Auto** — In this mode, the axes appear maximized in all displays only if the **Title** and **Y-Axis label** parameters are empty for every display. If you enter any value in any display for either of these parameters, the axes are not maximized.
- **On** — In this mode, the axes appear maximized in all displays. Any values entered into the **Title** and **Y-Axis label** parameters are hidden.
- **Off** — In this mode, none of the axes appear maximized.

Display Pane

The **Display** pane of the Visuals — Time Domain Properties dialog box appears as follows.

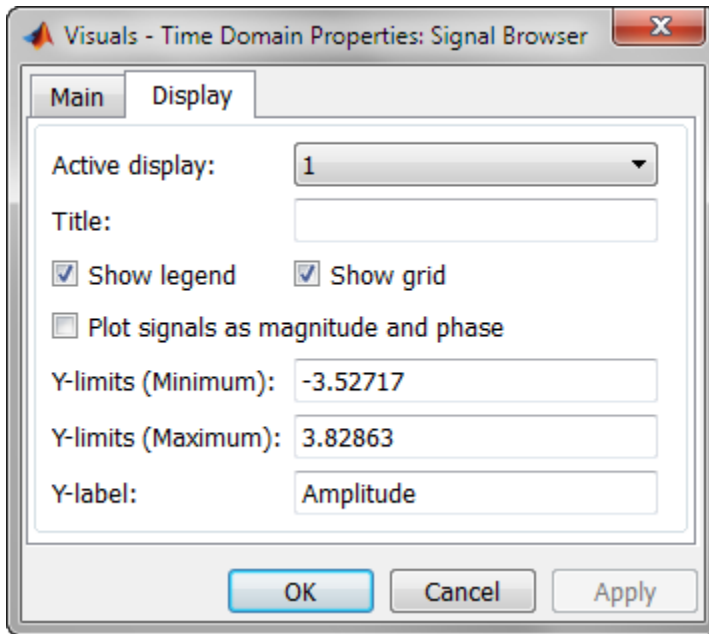

Active display

Specify the active display as an integer to get and set relevant properties. The number of a display corresponds to its column-wise placement index. Set this property to control which display has its axes colors, line properties, marker properties, and visibility changed.

When you use the Layout option to tile the window into multiple displays, the display highlighted in blue is referred to as the *active display*. The default setting is 1.

Title

Specify the active display title as text. By default, the active display has no title.

Show legend

Select this check box to show the legend in the display. The channel legend displays a name for each channel of each input signal. When the legend appears, you can place it anywhere inside of the scope window. To turn off the legend, clear the **Show legend** check box.

You can edit the name of any channel in the legend by double-clicking the current name and entering a new channel name. By default, if the signal has multiple channels, the scope uses an index number to identify each channel of that signal. To change the appearance of any channel of any input signal in the scope window, from the scope menu, select **View > Style**. The legend lets you modify what signals are shown. To show only one signal, click the signal name. To toggle a signal on/off, right-click the signal name.

Show grid

When you select this check box, a grid appears in the display of the scope figure. To hide the grid, clear this check box.

Plot signals as magnitude and phase

When you select this check box, the scope splits the display into a magnitude plot and a phase plot. By default, this check box is cleared. If the input signal has complex values, the scope plots the real and imaginary portions on the same axes. These real and imaginary portions appear as different-colored lines on the same axes, as shown in the following figure.

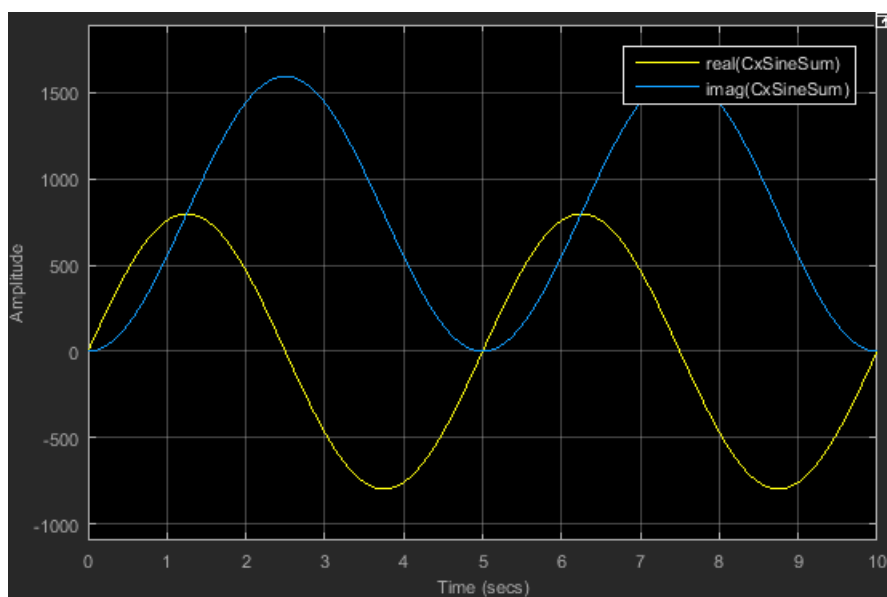

Selecting this check box and clicking the **Apply** or **OK** button changes the display. The magnitude of the input signal appears on the top axes and its phase, in degrees, appears on the bottom axes. See the following figure.

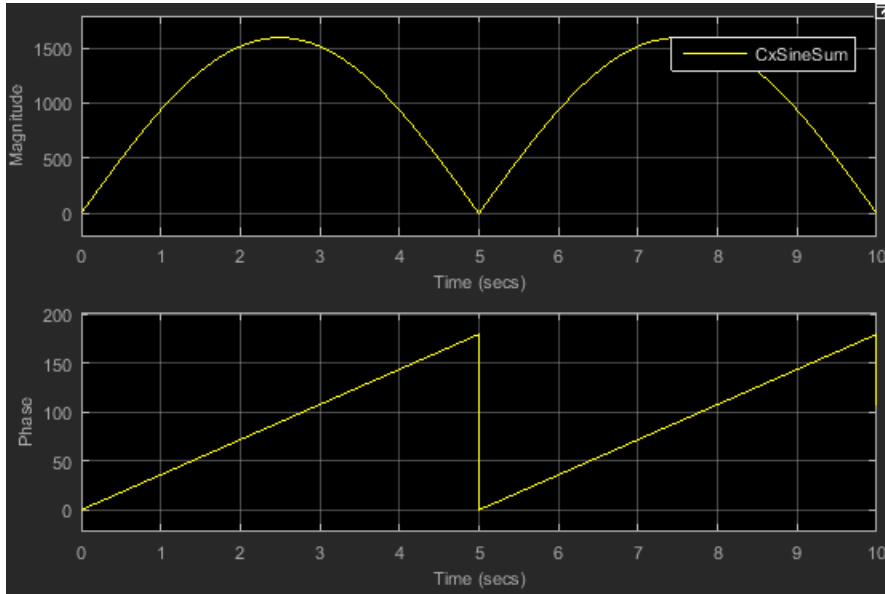

This feature is useful for complex-valued input signals. If the input is a real-valued signal, selecting this check box returns the absolute value of the signal for the magnitude. The phase is 0 degrees for nonnegative input and 180 degrees for negative input.

Y-limits (Minimum)

Specify the minimum value of the y-axis.

When you select the **Plot signal(s) as magnitude and phase** check box, the value of this property always applies to the magnitude plot on the top axes. The phase plot on the bottom axes is always limited to a minimum value of -180 degrees.

Y-limits (Maximum)

Specify the maximum value of the y-axis.

When you select the **Plot signal(s) as magnitude and phase** check box, the value of this property always applies to the magnitude plot on the top axes. The phase plot on the bottom axes is always limited to a maximum value of 180 degrees.

Y-label

Specify the text for the scope to display to the left of the y -axis.

This property becomes invisible when you select the **Plot signal(s) as magnitude and phase** check box. When you enable that property, the y -axis label always appears as **Magnitude** on the top axes and **Phase** on the bottom axes.

Style Dialog Box

In the **Style** dialog box, you can customize the style of displays. You can change the color of the figure containing the displays, the background and foreground colors of display axes, and properties of lines in a display. From the Signal Browser menu, select **View > Style** to open this dialog box.

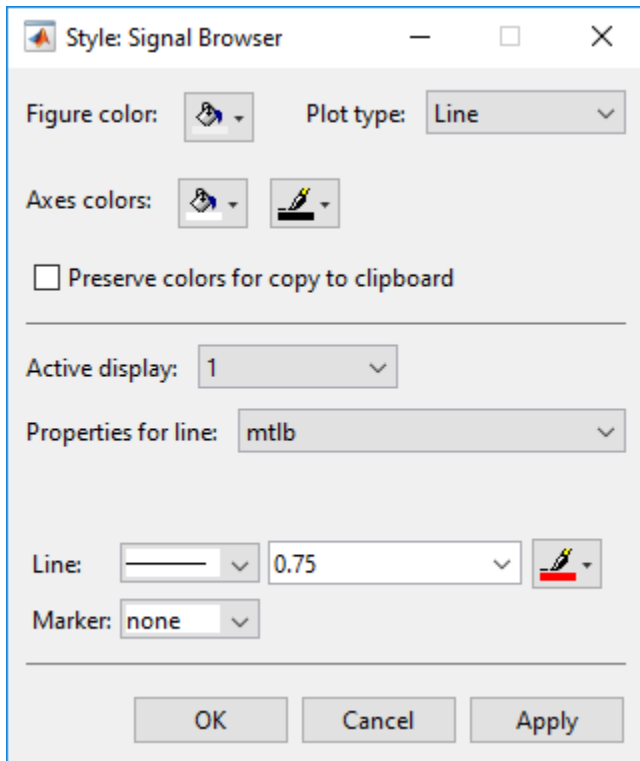

Properties

The **Style** dialog box allows you to modify the following properties of the Signal Browser:

Figure color

Specify the color that you want to apply to the background of the Signal Browser. By default, the figure color is gray.

Plot type

Specify the type of plot to use. The default setting is **Line**. Valid values for **Plot type** are:

- **Line** — Displays input signal as lines connecting each of the sampled values. This approach is similar to the functionality of the MATLAB `line` or `plot` function.

- **Stairs** — Displays input signal as a *stairstep* graph. A stairstep graph is made up of only horizontal lines and vertical lines. Each horizontal line represents the signal value for a discrete sample period and is connected to two vertical lines. Each vertical line represents a change in values occurring at a sample. This approach is equivalent to the MATLAB `stairs` function. Stairstep graphs are useful for drawing time history graphs of digitally sampled data.

Select display

Specify the active display as a number, where a display number corresponds to the index of the input signal. The number of a display corresponds to its column-wise placement index. The default setting is 1. Set this parameter to control which display should have its axes colors, line properties, marker properties, and visibility changed.

Axes colors

Specify the color that you want to apply to the background of the axes for the active display.

Preserve colors for copy to clipboard

Specify whether or not to use the displayed color of the scope when copying.

When you select **File > Copy to Clipboard**, the software changes the color of the scope to be printer friendly (white background, visible lines). If you want to copy and paste the scope with the colors displayed, select this check box.

Default: Off

Properties for line

Specify the signal for which you want to modify the visibility, line properties, and marker properties.

Visible

Specify whether the selected signal on the active display should be visible. If you clear this check box, the line disappears.

Line

Specify the line style, line width, and line color for the selected signal on the active display.

Marker

Specify marks for the selected signal on the active display to show at data points. This parameter is similar to the **Marker** property for the MATLAB Handle Graphics plot objects. You can choose any of the marker symbols from the following table.

Specifier	Marker Type
none	No marker (default)
○	Circle
□	Square
×	Cross
•	Point
+	Plus sign
*	Asterisk
◇	Diamond
▽	Downward-pointing triangle
△	Upward-pointing triangle
◁	Left-pointing triangle
▷	Right-pointing triangle
☆	Five-pointed star (pentagram)
☆☆	Six-pointed star (hexagram)

Filter Designer App

The Filter Designer app allows you to design and edit FIR and IIR filters. To launch the app, press either the **New** button or the **Edit** button under the **Filters** list box in SPTool.

The Filter Designer app has a Pole/Zero Editor you can access by selecting the  icon in the left column.

Filter Visualization Tool

The Filter Visualization Tool (fvtool) allows you to view the characteristics of a designed or imported filter, including its magnitude response, phase response, group delay, phase delay, pole-zero plot, impulse response, and step response. To activate FVTool, click the **View** button under the **Filters** list box in SPTool.

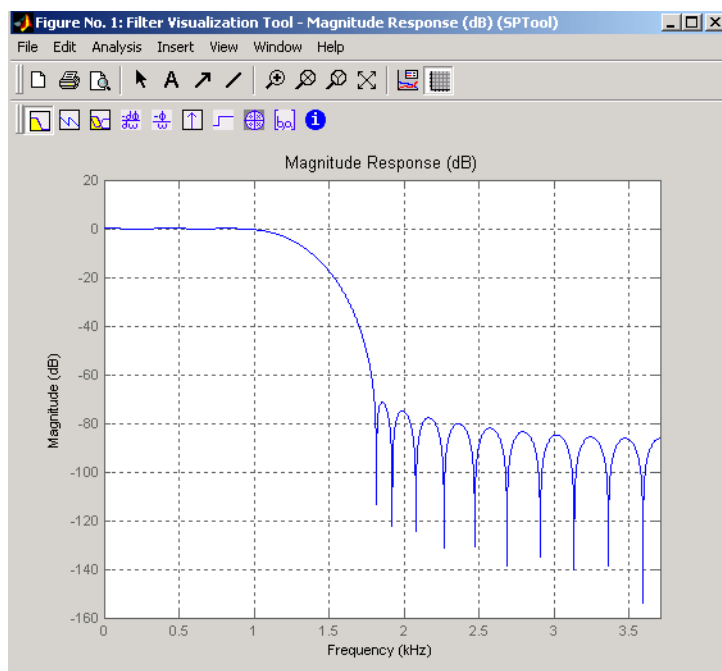

Spectrum Viewer

The Spectrum Viewer allows you to analyze frequency-domain data graphically using a variety of methods of spectral density estimation, including the Burg method, the FFT method, the multitaper method, the MUSIC eigenvector method, Welch's method, and the Yule-Walker autoregressive method. To activate the Spectrum Viewer:

- Click the **Create** button under the **Spectra** list box to compute the power spectral density for a signal selected in the **Signals** list box in SPTool. You may need to click **Apply** to view the spectra.

- Click the **View** button to analyze spectra selected under the **Spectra** list box in SPTool.
- Click the **Update** button under the **Spectra** list box in SPTool to modify a selected power spectral density signal.

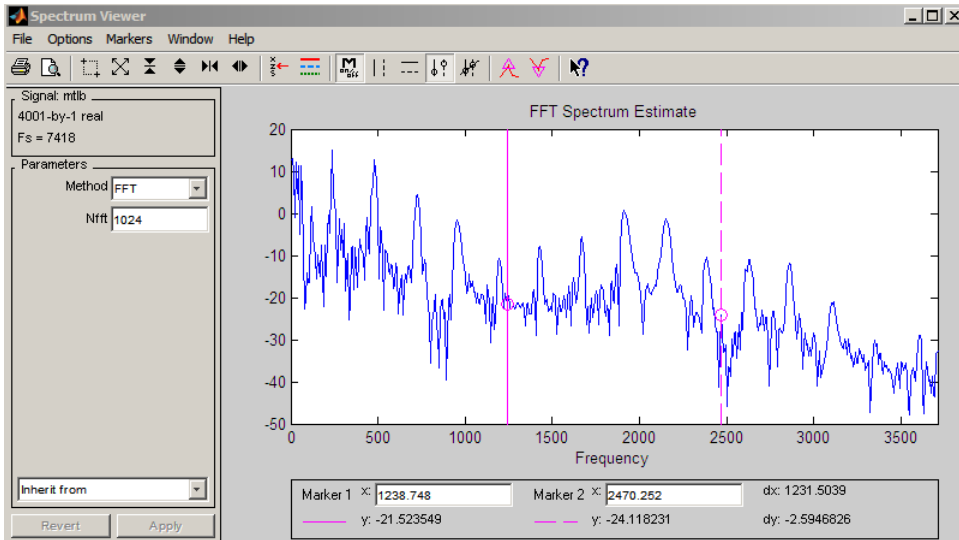

In addition, you can right-click in any plot display area to modify signal properties.

See Also

See Also

Apps

Filter Designer

Functions

findpeaks | fvtool

Introduced before R2006a

square

Square wave

Syntax

```
x = square(t)
x = square(t,duty)
```

Description

`x = square(t)` generates a square wave with period 2π for the elements of time vector `t`. `square(t)` is similar to `sin(t)`, but creates a square wave with peaks of ± 1 instead of a sine wave.

`x = square(t,duty)` generates a square wave with specified duty cycle, `duty`, which is a number between 0 and 100. The *duty cycle* is the percent of the period in which the signal is positive.

Examples

Generate Square Waves

Create a vector of 100 equally spaced numbers from 0 to 3π . Generate a square wave with a period of 2π .

```
t = linspace(0,3*pi)';
x = square(t);
```

Plot the square wave and overlay a sine. Normalize the x -axis by π . The generated square wave has a value of 1 at even multiples of π and a value of -1 at odd multiples of π . It is never 0 .

```
plot(t/pi,x,'.-',t/pi,sin(t))
```

```
xlabel('t / \pi')
grid on
```

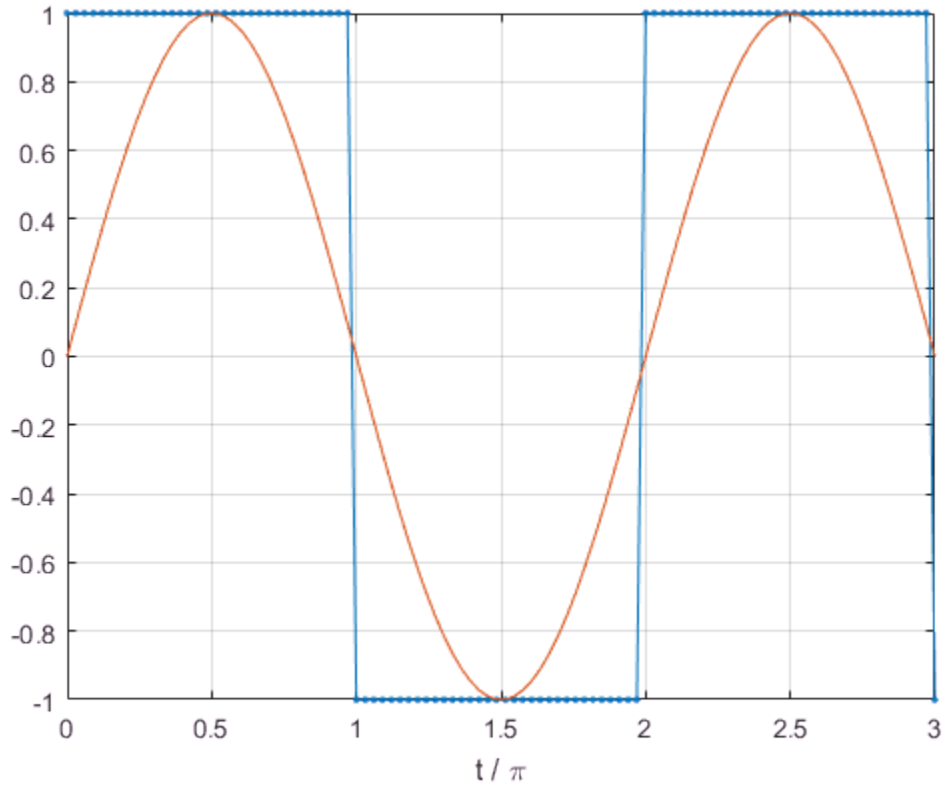

Repeat the calculation, but now evaluate `square(2*t)` at 121 equally spaced numbers between $-\pi$ and 2π . Change the amplitude to 1.15. Plot the wave and overlay a sine with the same parameters. This new wave is negative at $t = 0$ and positive at the endpoints.

```
t = linspace(-pi,2*pi,121);
x = 1.15*square(2*t);

plot(t/pi,x,'.-',t/pi,1.15*sin(2*t))
xlabel('t / \pi')
```

```
grid on
```

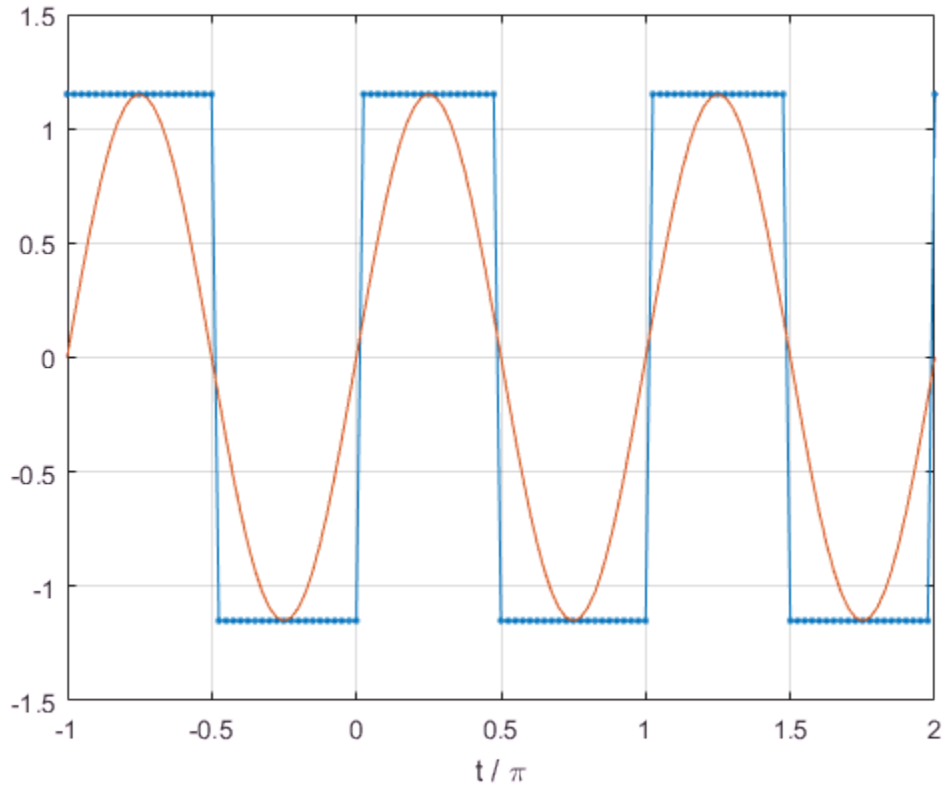

Duty Cycle of Square Wave

Generate a 30 Hz square wave sampled at 1 kHz for 70 ms. Specify a duty cycle of 37%. Add white Gaussian noise with a variance of 1/100.

```
t = 0:1/1e3:0.07;  
y = square(2*pi*30*t,37)+randn(size(t))/10;
```

Compute the duty cycle of the wave. Plot the waveform and annotate the duty cycle.

```
dutycycle(y,t)
```

```
ans = 0.3639
```

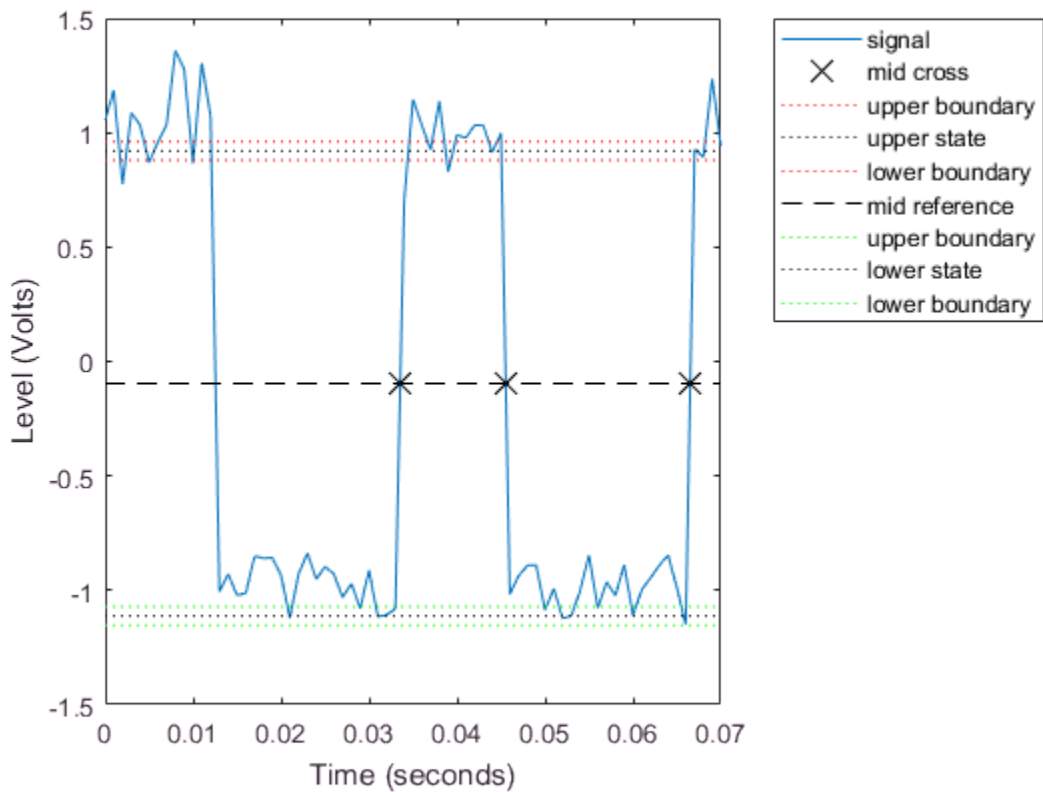

See Also

chirp | cos | diric | gauspuls | pulstran | rectpuls | sawtooth | sin | tripuls

Introduced before R2006a

SS

Convert digital filter to state-space representation

Syntax

```
[A,B,C,D] = ss(d)
```

Description

`[A,B,C,D] = ss(d)` converts a digital filter, `d`, to its state-space representation.

The state-space representation of a filter is given by

$$\begin{aligned}x(k+1) &= Ax(k) + Bu(k), \\y(k) &= Cx(k) + Du(k),\end{aligned}$$

where x is the state vector, u is the input vector, and y is the output vector.

Examples

State-Space Representation of a Lowpass IIR Filter

Design a lowpass IIR filter of order 6. Specify a normalized passband frequency of 0.2π rad/sample. Compute the state-space representation of the filter.

```
d = designfilt('lowpassiir','FilterOrder',6,'PassbandFrequency',0.2);
[A,B,C,D] = ss(d)
```

A =

```

1.5640   -0.9294         0         0         0         0
1.0000         0         0         0         0         0
0.1795    0.0036    1.6097   -0.8112         0         0
         0         0    1.0000         0         0         0
0.0020    0.0000    0.0408    0.0021    1.6956   -0.7409
         0         0         0         0    1.0000         0
```

B =

```
0.0913
      0
0.0046
      0
0.0001
      0
```

C =

```
0.0020    0.0000    0.0408    0.0021    3.6956    0.2591
```

D = 5.2030e-05

Input Arguments

d — Digital filter

`digitalFilter` object

Digital filter, specified as a `digitalFilter` object. Use `designfilt` to generate a digital filter based on frequency-response specifications.

Example: `d =`

```
designfilt('lowpassiir','FilterOrder',3,'HalfPowerFrequency',0.5)
```

specifies a third-order Butterworth filter with normalized 3-dB frequency 0.5π rad/sample.

Output Arguments

A — State matrix

matrix

State matrix, returned as a matrix.

Data Types: `double`

B — Input-to-state matrix

matrix

Input-to-state matrix, returned as a matrix.

Data Types: double

C — State-to-output matrix

matrix

State-to-output matrix, returned as a matrix.

Data Types: double

D — Feedthrough matrix

matrix

Feedthrough matrix, returned as a matrix.

Data Types: double

See Also

See Also

`designfilt` | `digitalFilter` | `tf` | `zpk`

Introduced in R2014a

ss2sos

Convert digital filter state-space parameters to second-order sections form

Syntax

```
[sos,g] = ss2sos(A,B,C,D)
[sos,g] = ss2sos(A,B,C,D,iu)
[sos,g] = ss2sos(A,B,C,D,'order')
[sos,g] = ss2sos(A,B,C,D,iu,'order')
[sos,g] = ss2sos(A,B,C,D,iu,'order','scale')
sos = ss2sos(...)
```

Description

`ss2sos` converts a state-space representation of a given digital filter to an equivalent second-order section representation.

`[sos,g] = ss2sos(A,B,C,D)` finds a matrix `sos` in second-order section form with gain `g` that is equivalent to the state-space system represented by input arguments `A`, `B`, `C`, and `D`. The input system must be single output and real. `sos` is an L -by-6 matrix

$$\text{sos} = \begin{bmatrix} b_{01} & b_{11} & b_{21} & 1 & a_{11} & a_{21} \\ b_{02} & b_{12} & b_{22} & 1 & a_{12} & a_{22} \\ \vdots & \vdots & \vdots & \vdots & \vdots & \vdots \\ b_{0L} & b_{1L} & b_{2L} & 1 & a_{1L} & a_{2L} \end{bmatrix}$$

whose rows contain the numerator and denominator coefficients b_{ik} and a_{ik} of the second-order sections of $H(z)$.

$$H(z) = g \prod_{k=1}^L H_k(z) = g \prod_{k=1}^L \frac{b_{0k} + b_{1k}z^{-1} + b_{2k}z^{-2}}{1 + a_{1k}z^{-1} + a_{2k}z^{-2}}$$

`[sos,g] = ss2sos(A,B,C,D,iu)` specifies a scalar `iu` that determines which input of the state-space system `A`, `B`, `C`, `D` is used in the conversion. The default for `iu` is 1.

`[sos,g] = ss2sos(A,B,C,D,'order')` and

`[sos,g] = ss2sos(A,B,C,D,iu,'order')` specify the order of the rows in `sos`, where `'order'` is

- `'down'`, to order the sections so the first row of `sos` contains the poles closest to the unit circle
- `'up'`, to order the sections so the first row of `sos` contains the poles farthest from the unit circle (default)

The zeros are always paired with the poles closest to them.

`[sos,g] = ss2sos(A,B,C,D,iu,'order','scale')` specifies the desired scaling of the gain and the numerator coefficients of all second-order sections, where `'scale'` is

- `'none'`, to apply no scaling (default)
- `'inf'`, to apply infinity-norm scaling
- `'two'`, to apply 2-norm scaling

Using infinity-norm scaling in conjunction with `up`-ordering minimizes the probability of overflow in the realization. Using 2-norm scaling in conjunction with `down`-ordering minimizes the peak round-off noise.

Note Infinity-norm and 2-norm scaling are appropriate only for direct-form II implementations.

`sos = ss2sos(...)` embeds the overall system gain, `g`, in the first section, $H_1(z)$, so that

$$H(z) = \prod_{k=1}^L H_k(z)$$

Note Embedding the gain in the first section when scaling a direct-form II structure is not recommended and may result in erratic scaling. To avoid embedding the gain, use `ss2sos` with two outputs.

Examples

Second-Order Section Form of a Filter

Design a 5th-order Butterworth lowpass filter using the `butter` function. Specify a cutoff frequency of 0.2π rad/sample. Express the output in state-space form. Convert the state-space result to second-order sections. Visualize the frequency response of the filter.

```
[A,B,C,D] = butter(5,0.2);  
sos = ss2sos(A,B,C,D)
```

```
sos =
```

```
    0.0013    0.0013         0    1.0000   -0.5095         0  
    1.0000    2.0013    1.0013    1.0000   -1.0966    0.3554  
    1.0000    1.9967    0.9967    1.0000   -1.3693    0.6926
```

```
freqz(sos)
```

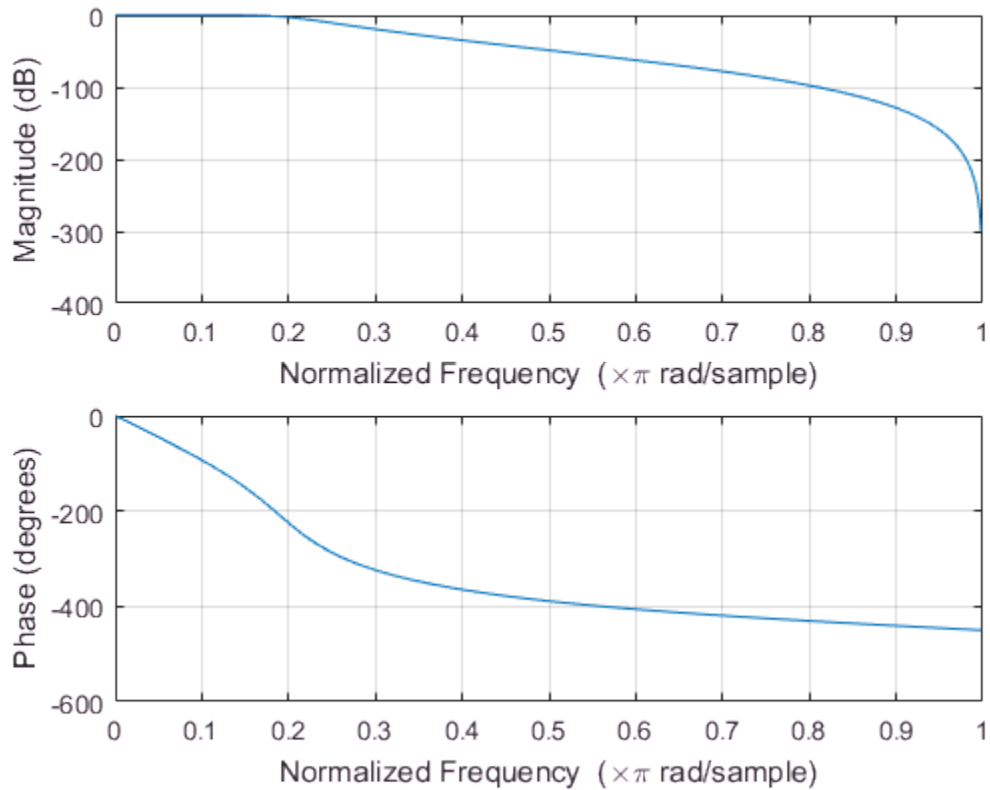

Mass-Spring System

A one-dimensional discrete-time oscillating system consists of a unit mass, m , attached to a wall by a spring of unit elastic constant. A sensor measures the acceleration, a , of the mass.

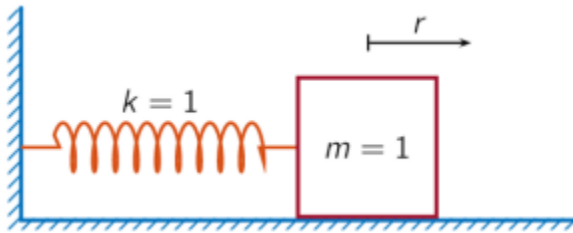

The system is sampled at $F_s = 5$ Hz. Generate 50 time samples. Define the sampling interval $\Delta t = 1/F_s$.

```
Fs = 5;
dt = 1/Fs;
N = 50;
t = dt*(0:N-1);
```

The oscillator can be described by the state-space equations

$$\begin{aligned} x(k+1) &= Ax(k) + Bu(k), \\ y(k) &= Cx(k) + Du(k), \text{ hfill} \end{aligned}$$

where $x = \begin{pmatrix} r & v \end{pmatrix}^T$ is the state vector, r and v are respectively the position and velocity of the mass, and the matrices

$$A = \begin{pmatrix} \text{hfill} \cos \Delta t & \sin \Delta t \\ -\sin \Delta t & \cos \Delta t \end{pmatrix}, \quad B = \begin{pmatrix} 1 - \cos \Delta t \\ \sin \Delta t \end{pmatrix}, \quad C = (-1 \ 0), \quad D = (1).$$

```
A = [cos(dt) sin(dt); -sin(dt) cos(dt)];
B = [1-cos(dt); sin(dt)];
C = [-1 0];
D = 1;
```

The system is excited with a unit impulse in the positive direction. Use the state-space model to compute the time evolution of the system starting from an all-zero initial state.

```
u = [1 zeros(1,N-1)];
```

```

x = [0;0];
for k = 1:N
    y(k) = C*x + D*u(k);
    x = A*x + B*u(k);
end

```

Plot the acceleration of the mass as a function of time.

```
stem(t,y,'filled')
```

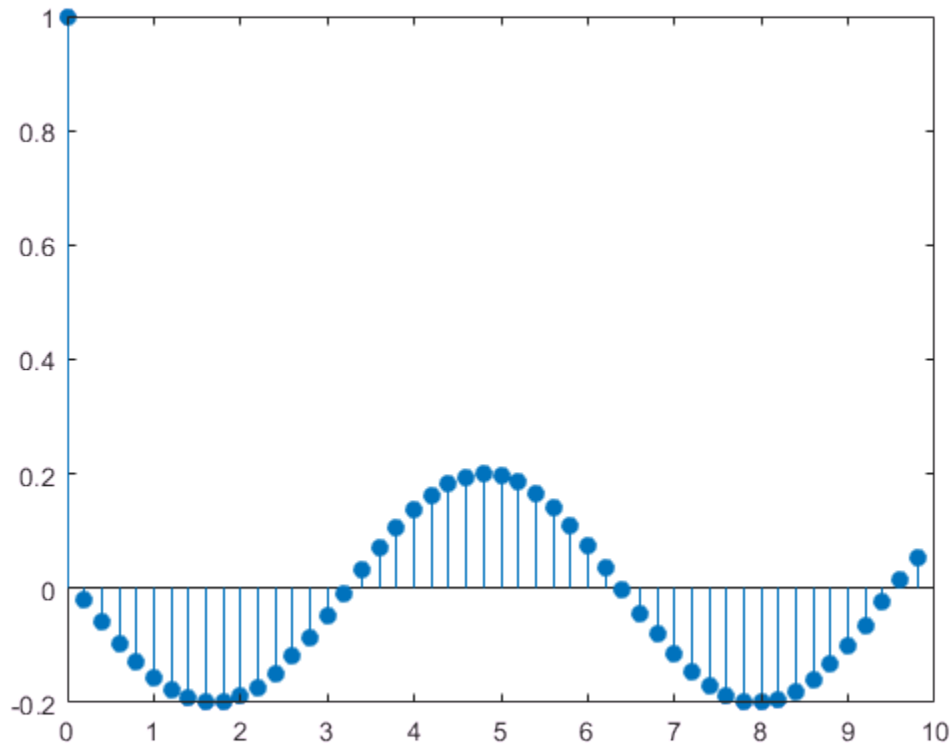

Compute the time-dependent acceleration using the transfer function to filter the input. Express the transfer function as second-order sections. Plot the result.

```
sos = ss2sos(A,B,C,D);
```

```
yt = sosfilt(sos,u);  
stem(t,yt,'filled')
```

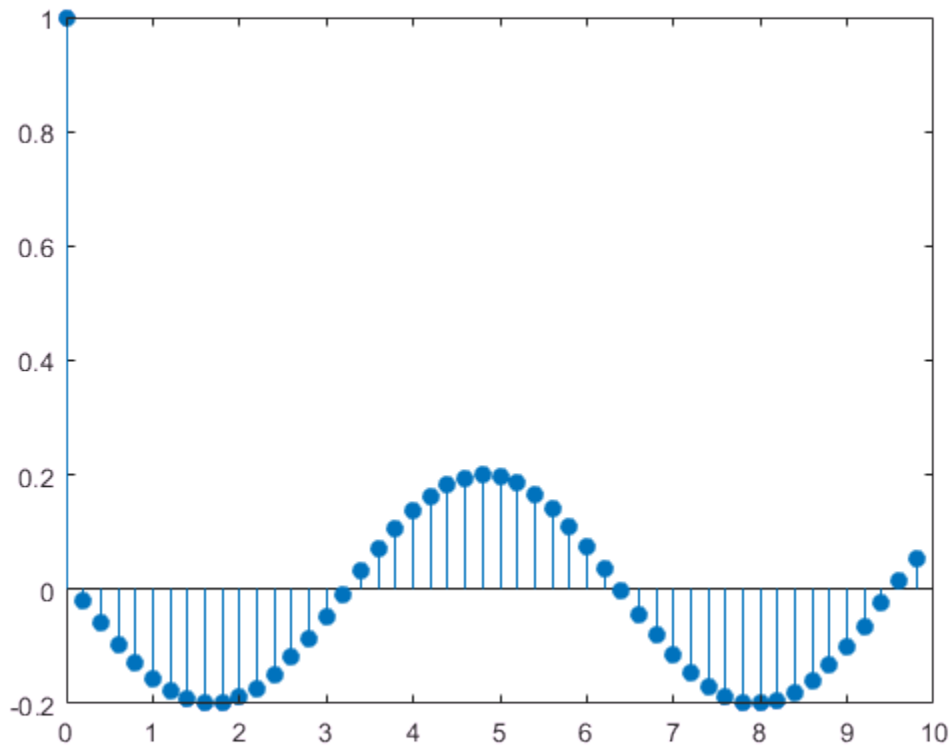

The result is the same in both cases.

Diagnostics

If there is more than one input to the system, `ss2sos` gives the following error message:

```
State-space system must have only one input.
```

Algorithms

`ss2sos` uses a four-step algorithm to determine the second-order section representation for an input state-space system:

- 1 It finds the poles and zeros of the system given by A, B, C, and D.
- 2 It uses the function `zp2sos`, which first groups the zeros and poles into complex conjugate pairs using the `cplxpair` function. `zp2sos` then forms the second-order sections by matching the pole and zero pairs according to the following rules:
 - a Match the poles closest to the unit circle with the zeros closest to those poles.
 - b Match the poles next closest to the unit circle with the zeros closest to those poles.
 - c Continue until all of the poles and zeros are matched.

`ss2sos` groups real poles into sections with the real poles closest to them in absolute value. The same rule holds for real zeros.

- 3 It orders the sections according to the proximity of the pole pairs to the unit circle. `ss2sos` normally orders the sections with poles closest to the unit circle last in the cascade. You can tell `ss2sos` to order the sections in the reverse order by specifying the 'down' flag.
- 4 `ss2sos` scales the sections by the norm specified in the 'scale' argument. For arbitrary $H(\omega)$, the scaling is defined by

$$\|H\|_p = \left[\frac{1}{2\pi} \int_0^{2\pi} |H(\omega)|^p d\omega \right]^{1/p}$$

where p can be either ∞ or 2. See the references for details. This scaling is an attempt to minimize overflow or peak round-off noise in fixed point filter implementations.

References

- [1] Jackson, L. B. *Digital Filters and Signal Processing*. 3rd Ed. Boston: Kluwer Academic Publishers, 1996, chap. 11.

[2] Mitra, S. K. *Digital Signal Processing: A Computer-Based Approach*. New York: McGraw-Hill, 1998, chap. 9.

[3] Vaidyanathan, P. P. “Robust Digital Filter Structures.” *Handbook for Digital Signal Processing* (S. K. Mitra and J. F. Kaiser, eds.). New York: John Wiley & Sons, 1993, chap. 7.

See Also

cplxpair | sos2ss | ss2tf | ss2zp | tf2sos | zp2sos

Introduced before R2006a

ss2zp

Convert state-space filter parameters to zero-pole-gain form

Syntax

`[z,p,k] = ss2zp(A,B,C,D,i)`

Description

`ss2zp` converts a state-space representation of a given system to an equivalent zero-pole-gain representation. The zeros, poles, and gains of state-space systems represent the transfer function in factored form.

`[z,p,k] = ss2zp(A,B,C,D,i)` calculates the transfer function in factored form

$$H(s) = \frac{Z(s)}{P(s)} = k \frac{(s - z_1)(s - z_2) \cdots (s - z_n)}{(s - p_1)(s - p_2) \cdots (s - p_n)}$$

of the continuous-time system

$$\begin{aligned} \dot{x} &= Ax + Bu \\ y &= Cx + Du \end{aligned}$$

from the *i*th input (using the *i*th columns of **B** and **D**). The column vector **p** contains the pole locations of the denominator coefficients of the transfer function. The matrix **Z** contains the numerator zeros in its columns, with as many columns as there are outputs *y* (rows in **C**). The column vector **k** contains the gains for each numerator transfer function.

`ss2zp` also works for discrete time systems. The input state-space system must be real.

The `ss2zp` function is part of the standard MATLAB language.

Examples

Zeros, Poles, and Gain of a Discrete-Time System

Consider a discrete-time system defined by the transfer function

$$H(z) = \frac{2 + 3z^{-1}}{1 + 0.4z^{-1} + z^{-2}}.$$

Determine its zeros, poles, and gain directly from the transfer function. Pad the numerator with zeros so it has the same length as the denominator.

```
b = [2 3 0];  
a = [1 0.4 1];  
[z,p,k] = tf2zp(b,a)
```

```
z =  
  
      0  
-1.5000
```

```
p =  
-0.2000 + 0.9798i  
-0.2000 - 0.9798i
```

```
k = 2
```

Express the system in state-space form and determine the zeros, poles, and gain using `ss2zp`.

```
[A,B,C,D] = tf2ss(b,a);  
[z,p,k] = ss2zp(A,B,C,D,1)
```

```
z =  
  
      0  
-1.5000
```

```
p =  
-0.2000 + 0.9798i  
-0.2000 - 0.9798i
```

k = 2

Algorithms

ss2zp finds the poles from the eigenvalues of the A array. The zeros are the finite solutions to a generalized eigenvalue problem:

```
z = eig([A B;C D], diag([ones(1,n) 0]));
```

In many situations this algorithm produces spurious large, but finite, zeros. **ss2zp** interprets these large zeros as infinite.

ss2zp finds the gains by solving for the first nonzero Markov parameters.

References

[1] Laub, A. J., and B. C. Moore. "Calculation of Transmission Zeros Using QZ Techniques." *Automatica*. Vol. 14, 1978, p. 557.

See Also

sos2zp | ss2sos | ss2tf | tf2zp | tf2zpk | zp2ss

Introduced before R2006a

statelevels

State-level estimation for bilevel waveform with histogram method

Syntax

```
LEVELS = statelevels(X)  
LEVELS = statelevels(X,NBINS)  
LEVELS = statelevels(X,NBINS,METHOD)  
[LEVELS,HISTOGRAM] = statelevels(...)  
[LEVELS,HISTOGRAM,BINLEVELS] = statelevels(...)  
statelevels(...)
```

Description

`LEVELS = statelevels(X)` estimates the low- and high-state levels in the bilevel waveform, `X`, using the histogram method. See “Algorithms” on page 1-2321.

`LEVELS = statelevels(X,NBINS)` specifies the number of bins to use in the histogram as a positive scalar. If unspecified, `NBINS` defaults to 100.

`LEVELS = statelevels(X,NBINS,METHOD)` estimates state levels using the mean or mode of the subhistograms. Valid entries for `METHOD` are 'mean' or 'mode'. `METHOD` defaults to 'mode'. See “Algorithms” on page 1-2321.

`[LEVELS,HISTOGRAM] = statelevels(...)` returns the histogram, `HISTOGRAM`, of the values in `X`.

`[LEVELS,HISTOGRAM,BINLEVELS] = statelevels(...)` returns the centers of the histogram bins.

`statelevels(...)` displays a plot of the signal and the corresponding computed histogram.

Input Arguments

X

Bilevel waveform. **X** is a real-valued row or column vector.

NBINS

Number of histogram bins

Default: 100

METHOD

State-level estimation method in the subhistograms. **METHOD** specifies the statistic to use for the estimation of the low- and high-state levels. Valid entries for **METHOD** are 'mode' or 'mean'. See “Algorithms” on page 1-2321.

Default: 'mode'

Output Arguments

LEVELS

Levels of low and high states. **LEVELS** is a 1-by-2 row vector of state levels estimated by the histogram method. The first element of **LEVELS** is the low-state level. The second element of **LEVELS** is the high-state level.

HISTOGRAM

Histogram counts (frequencies). **HISTOGRAM** is a column vector with **NBINS** elements containing the number of data values in each histogram bin.

BINLEVELS

Histogram bin centers. **BINLEVELS** is a column vector containing the bin centers for the histogram counts in **HISTOGRAM**.

Examples

Display State Levels and Subhistograms

Estimate the low- and high-state levels of 2.3 V underdamped clock data. Plot the data with the estimated state levels and subhistograms.

```
load('clockex.mat','x')  
statelevels(x);
```

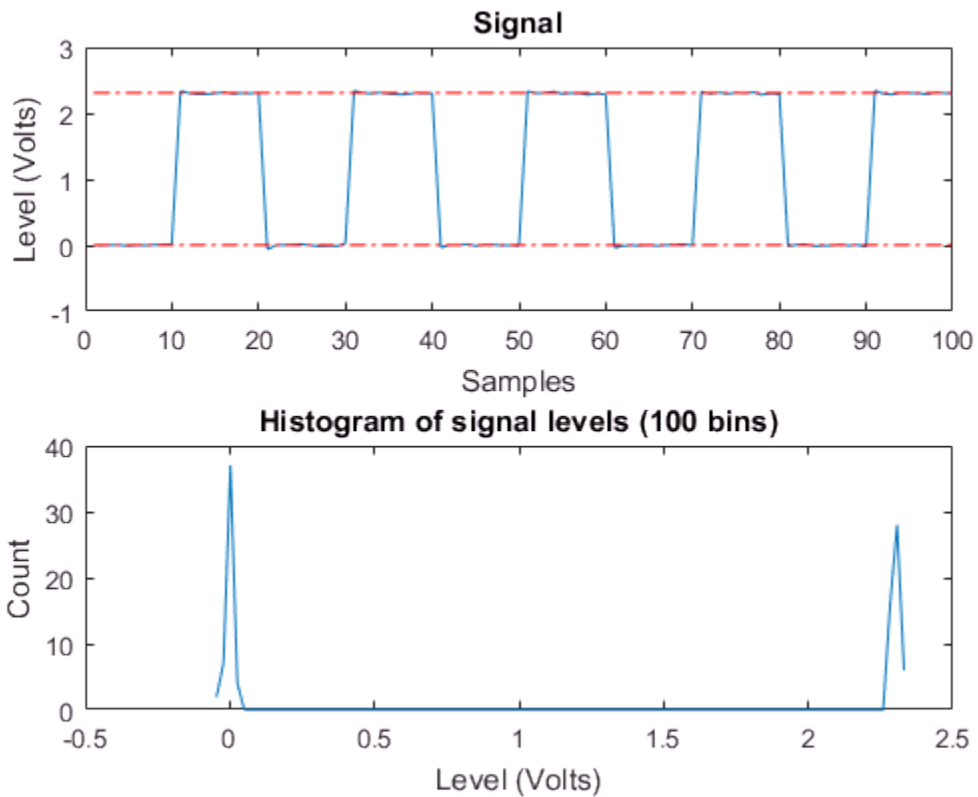

State Levels with 100 Bins and Modes of Subhistograms

Estimate the low and high-state levels of 2.3 V underdamped clock data sampled at 4 MHz.

Use the default number of bins and modes of the subhistograms to estimate the state levels.

```
load('clockex.mat','x','t')
levs = statelevels(x);
```

Plot the clock data with the lines indicating the estimated low and high-state levels.

```
statelevels(x)
```

```
ans =
```

```
    0.0027    2.3068
```

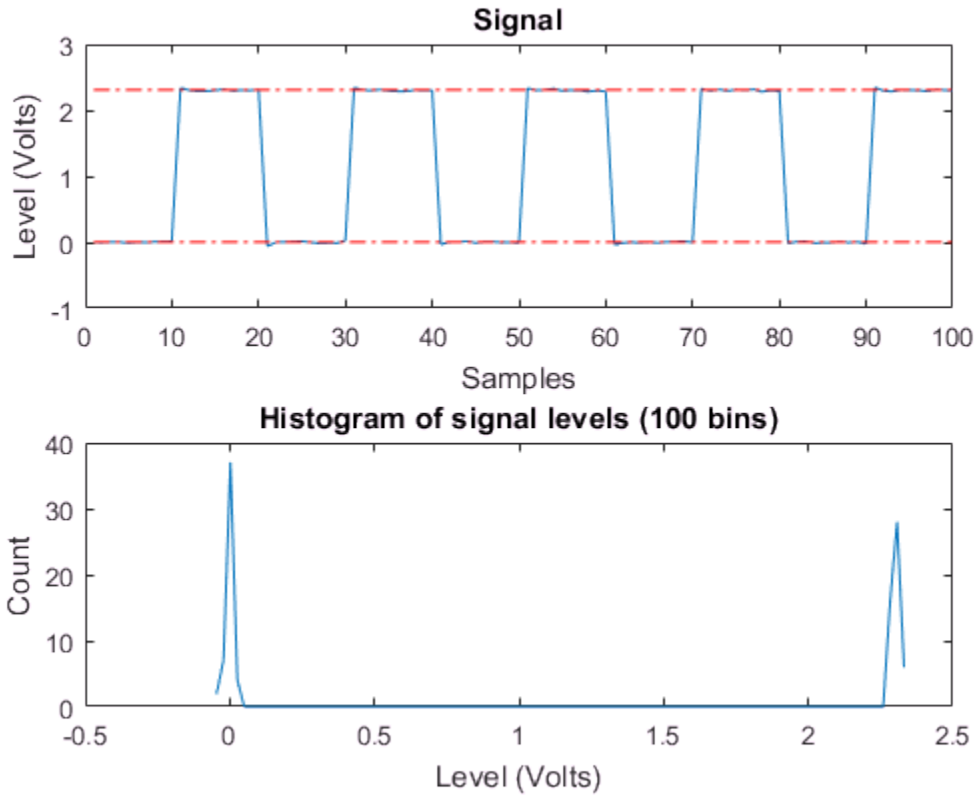

State Levels Using Means of Subhistograms

Estimate the low and high-state levels of 2.3 V underdamped clock data sampled at 4 MHz.

Use the default number of bins and means of the subhistograms to estimate the state levels. Plot the clock data with the lines indicating the estimated low and high-state levels.

```
load('clockex.mat','x','t')
statelevels(x,1e3,'mean')
```

```
ans =  
    -0.0014    2.3014
```

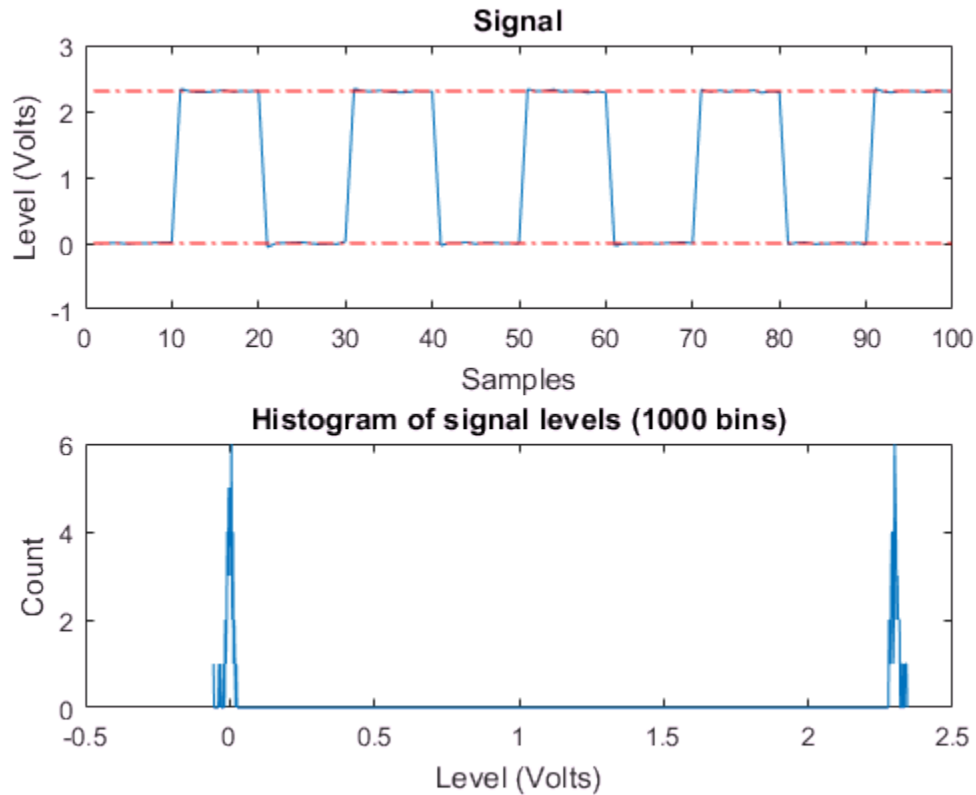

Histogram Counts and Histogram Bin Centers

Estimate the low- and high-state levels of 2.3 V underdamped clock data sampled at 4 MHz. Return the histogram counts and histogram bin centers used in the histogram method. Use four bins.

```
load('clockex.mat', 'x', 't')
```

```
[levs,histog,bilevs] = statelevels(x,4)
```

```
levs =
```

```
    0.2427    2.0428
```

```
histog =
```

```
    50
```

```
     0
```

```
     0
```

```
    50
```

```
bilevs =
```

```
    0.2427
```

```
    0.8427
```

```
    1.4428
```

```
    2.0428
```

Plot the waveform and annotate the levels.

```
statelevels(x,4);
```

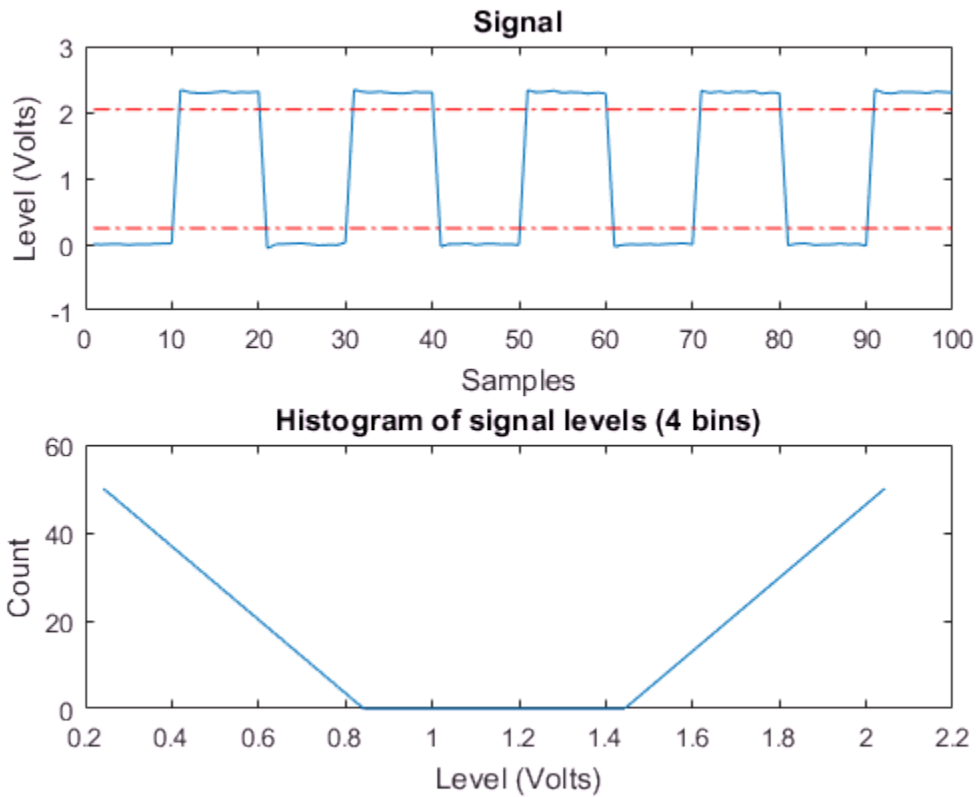

Definitions

State

A particular level, which can be associated with an upper- and lower-state boundary. States are ordered from the most negative to the most positive. In a bilevel waveform, the most negative state is the low state. The most positive state is the high state.

State-Level Tolerances

Each state level can have associated lower- and upper-state boundaries. These state boundaries are defined as the state level plus or minus a scalar multiple of the difference between the high state and the low state. To provide a useful tolerance region, the scalar is typically a small number such as 2/100 or 3/100. In general, the $\alpha\%$ region for the low state is defined as

$$S_1 \pm \frac{\alpha}{100}(S_2 - S_1),$$

where S_1 is the low-state level and S_2 is the high-state level. Replace the first term in the equation with S_2 to obtain the $\alpha\%$ tolerance region for the high state.

The following figure illustrates lower and upper 2% state boundaries (tolerance regions) for a positive-polarity bilevel waveform. The red dashed lines indicate the estimated state levels.

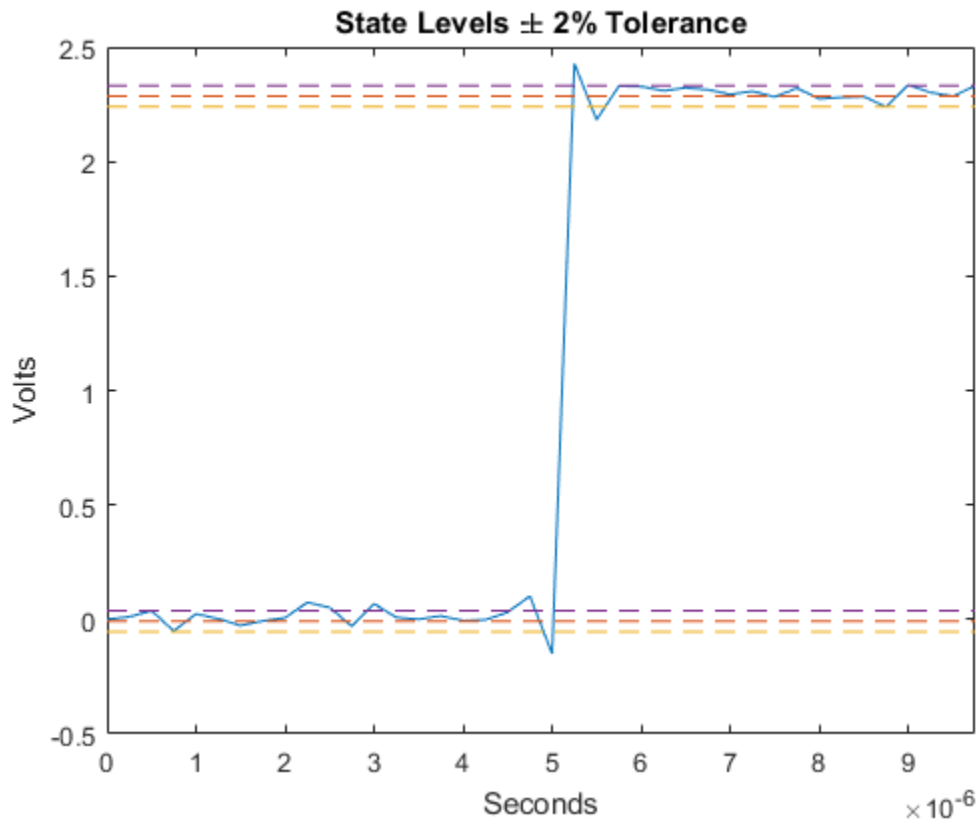

Algorithms

`statelevels` uses the histogram method to estimate the states of a bilevel waveform. The histogram method is described in [1]. To summarize the method:

- 1 Determine the maximum and minimum amplitudes and amplitude range of the data.
- 2 For the specified number of histogram bins, determine the bin width as the ratio of the amplitude range to the number of bins.
- 3 Sort the data values into the histogram bins.
- 4 Identify the lowest-indexed histogram bin, i_{low} , and highest-indexed histogram bin, i_{high} , with nonzero counts.

- 5 Divide the histogram into two subhistograms.

The indices of the lower histogram bins are $i_{low} \leq i \leq 1/2(i_{high} - i_{low})$.

The indices of the upper histogram bins are $i_{low} + 1/2(i_{high} - i_{low}) \leq i \leq i_{high}$.

- 6 Compute the state levels by determining the mode or mean of the lower and upper histograms.

References

- [1] *IEEE Standard on Transitions, Pulses, and Related Waveforms*, IEEE Standard 181, 2003, pp. 15–17.

See Also

See Also

midcross | overshoot | risetime | undershoot

Introduced in R2012a

stepz

Step response of digital filter

Syntax

```
[h,t] = stepz(b,a)
[h,t] = stepz(sos)
[h,t] = stepz(d)
[h,t] = stepz(...,n)
[h,t] = stepz(...,n,fs)
stepz(...)
```

Description

`[h,t] = stepz(b,a)` returns the step response of the filter with numerator coefficients, **b**, and denominator coefficients, **a**. **stepz** chooses the number of samples and returns the response in the column vector **h** and sample times in the column vector **t** (where **t** = `[0:n-1]'`, and $n = \text{length}(\mathbf{t})$ is computed automatically).

`[h,t] = stepz(sos)` returns the step response of the second order sections matrix, **sos**. **sos** is a K -by-6 matrix, where the number of sections, K , must be greater than or equal to 2. If the number of sections is less than 2, **stepz** considers the input to be the numerator vector, **b**. Each row of **sos** corresponds to the coefficients of a second-order (biquad) filter. The i th row of the **sos** matrix corresponds to `[bi(1) bi(2) bi(3) ai(1) ai(2) ai(3)]`.

`[h,t] = stepz(d)` returns the step response of the digital filter, **d**. Use **designfilt** to generate **d** based on frequency-response specifications.

`[h,t] = stepz(...,n)` computes the first n samples of the step response when n is an integer (**t** = `[0:n-1]'`). If n is a vector of integers, the step response is computed only at those integer values with 0 denoting the time origin.

`[h,t] = stepz(...,n,fs)` computes n samples and produces a vector **t** of length n so that the samples are spaced $1/fs$ units apart. **fs** is assumed to be in Hz.

`stepz(...)` with no output arguments plots the step response of the filter. If you input the filter coefficients or second order sections matrix, the current figure window is used. If you input a `digitalFilter`, the step response is displayed in `fvtool`.

Note: If the input to `stepz` is single precision, the step response is calculated using single-precision arithmetic. The output, `h`, is single precision.

Examples

Step Response of a Butterworth Filter

Create a third-order Butterworth filter with normalized half-power frequency 0.4π rad/sample. Display its step response.

```
[b,a] = butter(3,0.4);  
stepz(b,a)  
grid
```

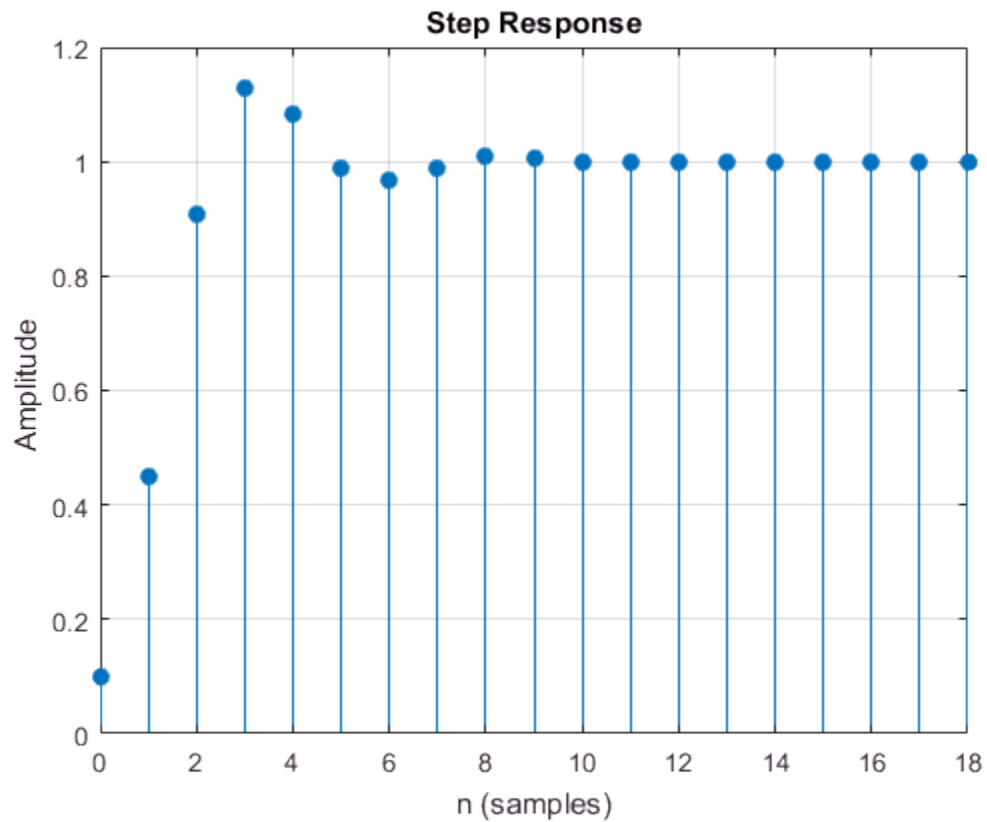

Create an identical filter using `designfilt` and display its step response using `fvtool`.

```
d = designfilt('lowpassiir','FilterOrder',3,'HalfPowerFrequency',0.4);  
stepz(d)
```

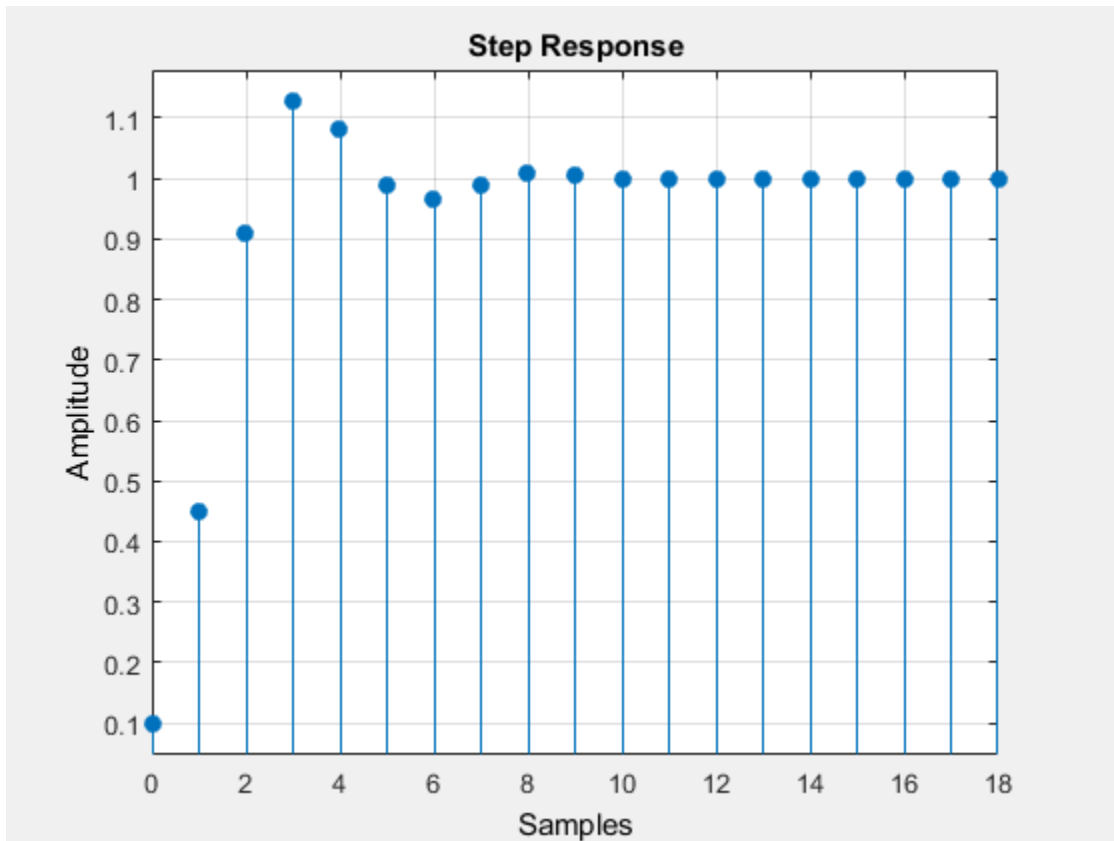

Step Response of an Elliptic Filter

Design a fourth-order lowpass elliptic filter with normalized passband frequency 0.4π rad/sample. Specify a passband ripple of 0.5 dB and a stopband attenuation of 20 dB. Plot the first 50 samples of the filter's step response.

```
[b,a] = ellip(4,0.5,20,0.4);  
stepz(b,a,50)  
grid
```

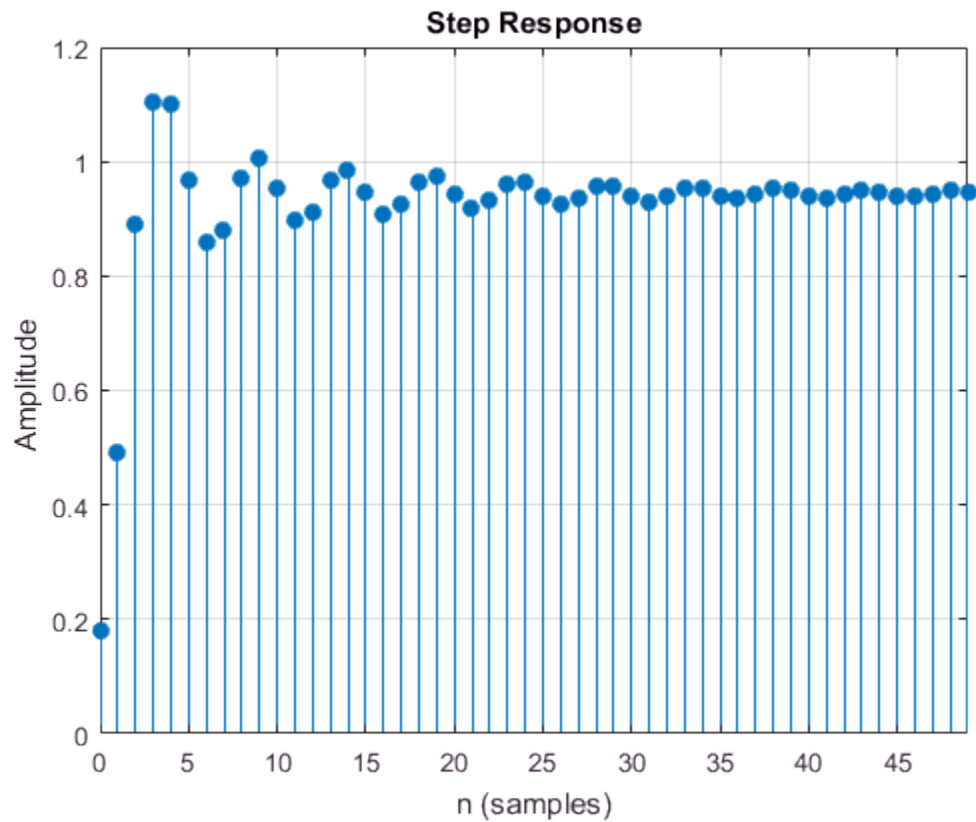

Create the same filter using `designfilt` and display its step response using `fvtool`.

```
d = designfilt('lowpassiir','FilterOrder',4,'PassbandFrequency',0.4, ...  
              'PassbandRipple',0.5,'StopbandAttenuation',20, ...  
              'DesignMethod','ellip');  
stepz(d,50)
```

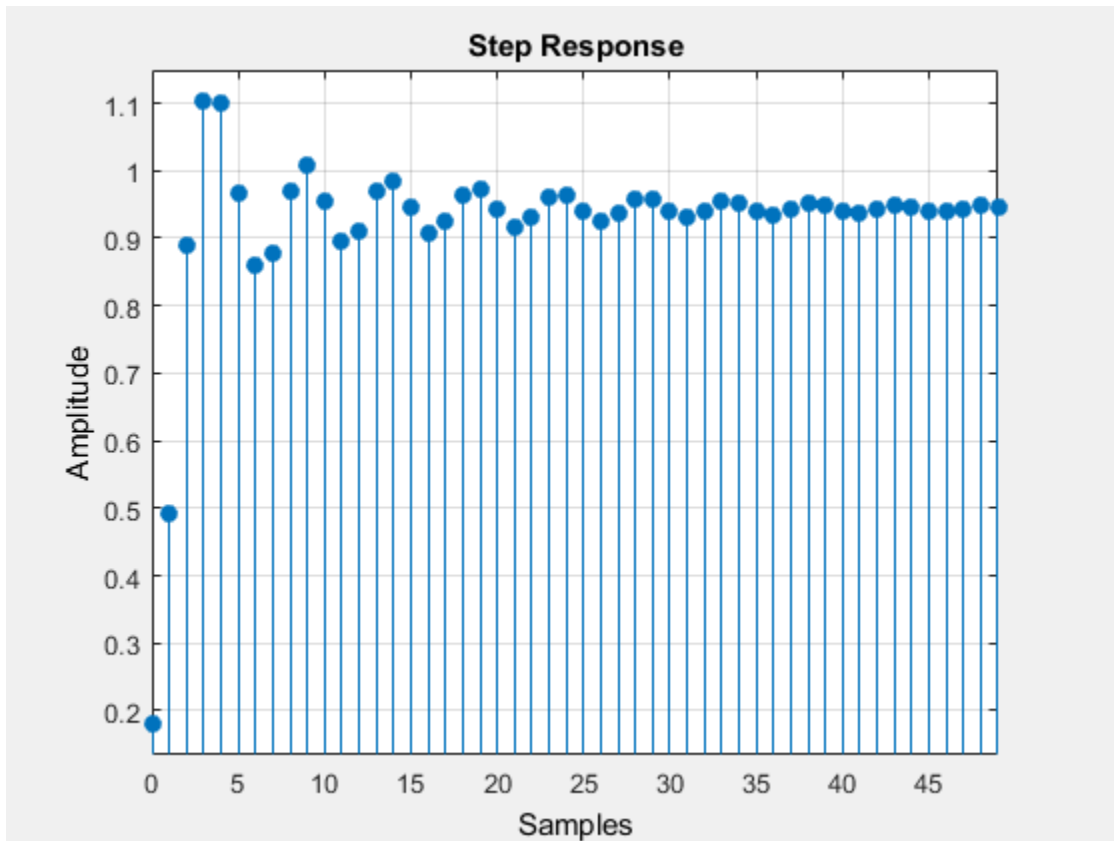

Algorithms

`stepz` filters a length `n` step sequence using

```
filter(b,a,ones(1,n))
```

and plots the results using `stem`.

To compute `n` in the auto-length case, `stepz` either uses `n = length(b)` for the FIR case or first finds the poles using `p = roots(a)`, if `length(a)` is greater than 1.

If the filter is unstable, `n` is chosen to be the point at which the term from the largest pole reaches 10^6 times its original value.

If the filter is stable, `n` is chosen to be the point at which the term due to the largest amplitude pole is 5×10^{-5} of its original amplitude.

If the filter is oscillatory (poles on the unit circle only), `stepz` computes five periods of the slowest oscillation.

If the filter has both oscillatory and damped terms, `n` is chosen to equal five periods of the slowest oscillation or the point at which the term due to the pole of largest nonunit amplitude is 5×10^{-5} times its original amplitude, whichever is greater.

`stepz` also allows for delays in the numerator polynomial. The number of delays is incorporated into the computation for the number of samples.

See Also

`designfilt` | `digitalFilter` | `freqz` | `grpdelay` | `impz` | `phasez` | `zplane`

Introduced before R2006a

stmcb

Compute linear model using Steiglitz-McBride iteration

Syntax

```
[b,a] = stmcb(h,nb,na)
[b,a] = stmcb(y,x,nb,na)
[b,a] = stmcb(h,nb,na,niter)
[b,a] = stmcb(y,x,nb,na,niter)
[b,a] = stmcb(h,nb,na,niter,ai)
[b,a] = stmcb(y,x,nb,na,niter,ai)
```

Description

Steiglitz-McBride iteration is an algorithm for finding an IIR filter with a prescribed time-domain impulse response. It has applications in both filter design and system identification (parametric modeling).

`[b,a] = stmcb(h,nb,na)` finds the coefficients **b** and **a** of the system $b(z)/a(z)$ with approximate impulse response **h**, exactly **nb** zeros, and exactly **na** poles.

`[b,a] = stmcb(y,x,nb,na)` finds the system coefficients **b** and **a** of the system that, given **x** as input, has **y** as output. **x** and **y** must be the same length.

`[b,a] = stmcb(h,nb,na,niter)` and

`[b,a] = stmcb(y,x,nb,na,niter)` use **niter** iterations. The default for **niter** is 5.

`[b,a] = stmcb(h,nb,na,niter,ai)` and

`[b,a] = stmcb(y,x,nb,na,niter,ai)` use the vector **ai** as the initial estimate of the denominator coefficients. If **ai** is not specified, `stmcb` uses the output argument from `[b,ai] = prony(h,0,na)` as the vector **ai**.

`stmcb` returns the IIR filter coefficients in length **nb+1** and **na+1** row vectors **b** and **a**. The filter coefficients are ordered in descending powers of z .

$$H(z) = \frac{B(z)}{A(z)} = \frac{b(1) + b(2)z^{-1} + \dots + b(nb + 1)z^{-nb}}{a(1) + a(2)z^{-1} + \dots + a(na + 1)z^{-na}}$$

Examples

Steiglitz-McBride Approximation of a Filter

Approximate the impulse response of an IIR filter with a system of lower order.

Specify a 6th-order Butterworth filter with normalized 3-dB frequency 0.2π rad/sample.

```
d = designfilt('lowpassiir', 'FilterOrder', 6, ...  
             'HalfPowerFrequency', 0.2, 'DesignMethod', 'butter');
```

Use the Steiglitz-McBride iteration to approximate the filter with a 4th-order system.

```
h = impz(d);  
[bb,aa] = stmcb(h,4,4);
```

Plot the frequency responses of the two systems.

```
hfvt = fvtool(d,bb,aa, 'Analysis', 'freq');  
legend(hfvt, 'Butterworth', 'Steiglitz-McBride')
```

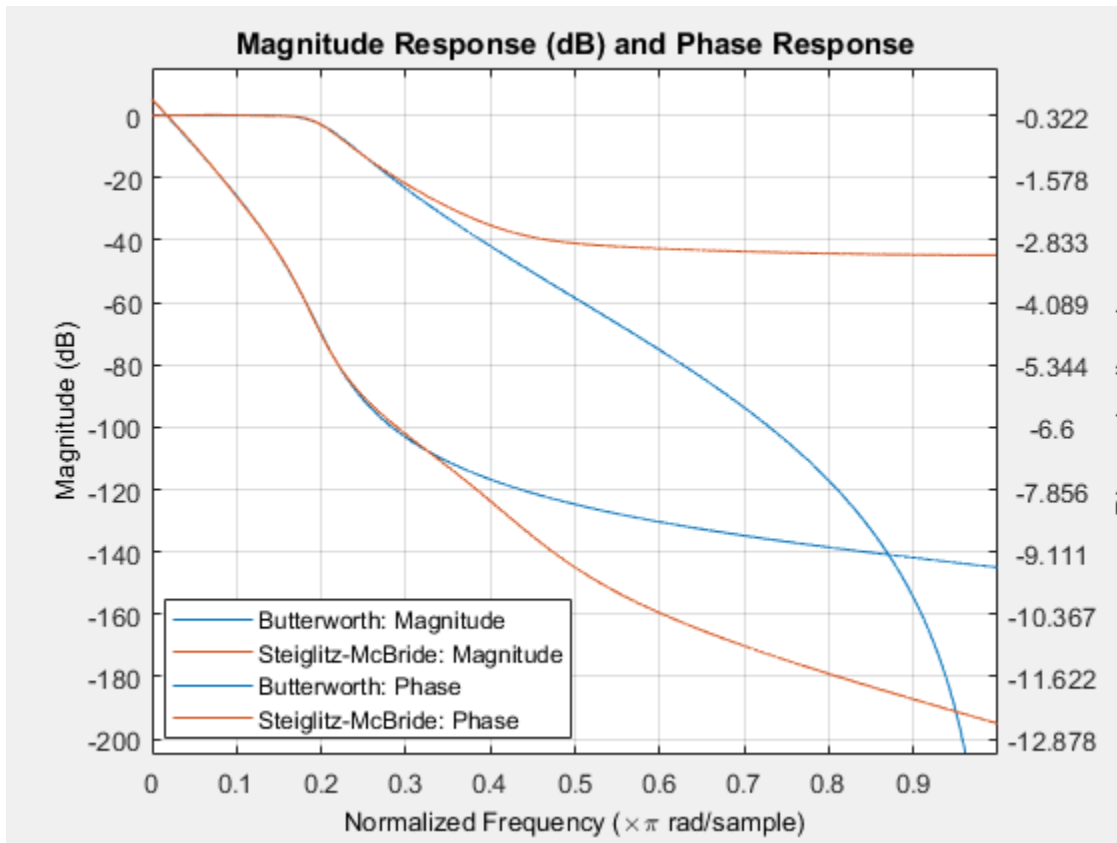

Diagnostics

If x and y have different lengths, `stmcb` produces this error message:

```
Input signal X and output signal Y must
have the same length.
```

Algorithms

stmcb attempts to minimize the squared error between the impulse response h of $b(z)/a(z)$ and the input signal x .

$$\min_{a,b} \sum_{i=0}^{\infty} |x(i) - h(i)|^2$$

stmcb iterates using two steps:

- 1 It prefilters h and x using $1/a(z)$.
- 2 It solves a system of linear equations for b and a using \backslash .

stmcb repeats this process `niter` times. No checking is done to see if the b and a coefficients have converged in fewer than `niter` iterations.

References

- [1] Steiglitz, K., and L. E. McBride. "A Technique for the Identification of Linear Systems." *IEEE Transactions on Automatic Control*. Vol. AC-10, 1965, pp.461–464.
- [2] Ljung, Lennart. *System Identification: Theory for the User*. 2nd Edition. Upper Saddle River, NJ: Prentice Hall, 1999, p.354.

See Also

levinson | lpc | aryule | prony

Introduced before R2006a

strips

Strip plot

Syntax

```
strips(x)
strips(x,n)
strips(x,sd,fs)
strips(x,sd,fs,scale)
```

Description

`strips(x)` plots vector `x` in horizontal strips of length 250. If `x` is a matrix, `strips(x)` plots each column of `x`. The left-most column (column 1) is the top horizontal strip.

`strips(x,n)` plots vector `x` in strips that are each `n` samples long.

`strips(x,sd,fs)` plots vector `x` in strips of duration `sd` seconds, given a sampling frequency of `fs` samples per second.

`strips(x,sd,fs,scale)` scales the vertical axes.

If `x` is a matrix, `strips(x,n)`, `strips(x,sd,fs)`, and `strips(x,sd,fs,scale)` plot the different columns of `x` on the same strip plot.

`strips` ignores the imaginary part of complex-valued `x`.

Examples

Strip Plot of Frequency-Modulated Sinusoid

Plot two seconds of a frequency-modulated sinusoid in 0.25 second strips. Specify a sample rate of 1 kHz.

```
fs = 1000;
t = 0:1/fs:2;
```

```
x = vco(sin(2*pi*t),[10 490],fs);  
strips(x,0.25,fs)
```

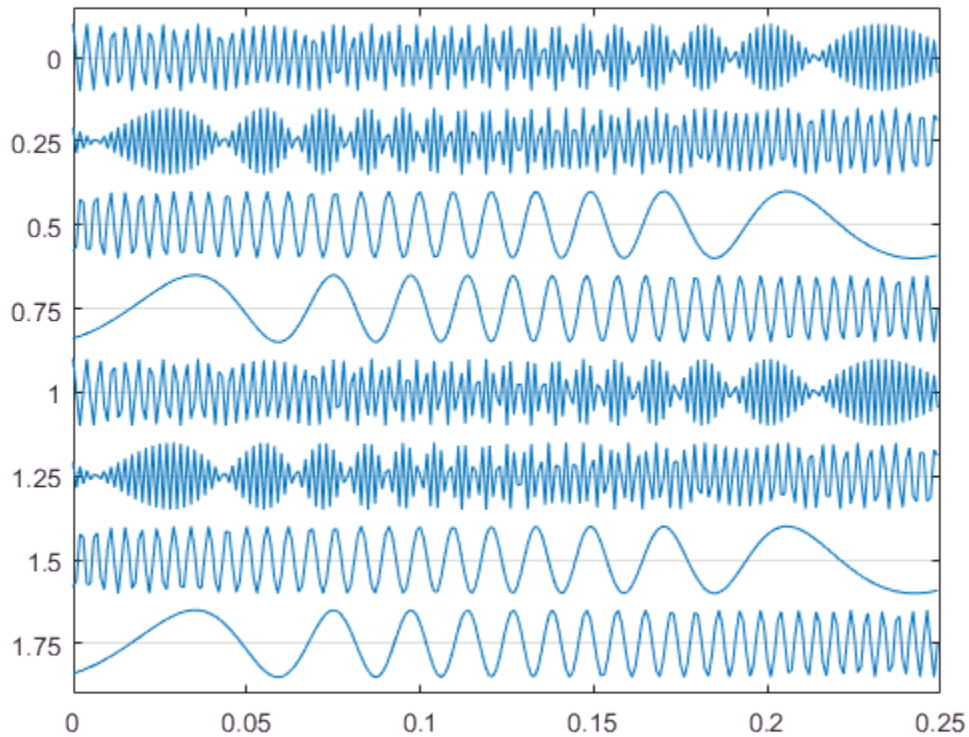

Strip Plot of Speech Signal

Load a speech signal sampled at $F_s = 7418$ Hz. The file contains a recording of a female voice saying the word "MATLAB®."

```
load mtlb
```

Plot the signal in 0.18 second long strips.

```
strips(mtlb,0.18,Fs)
```

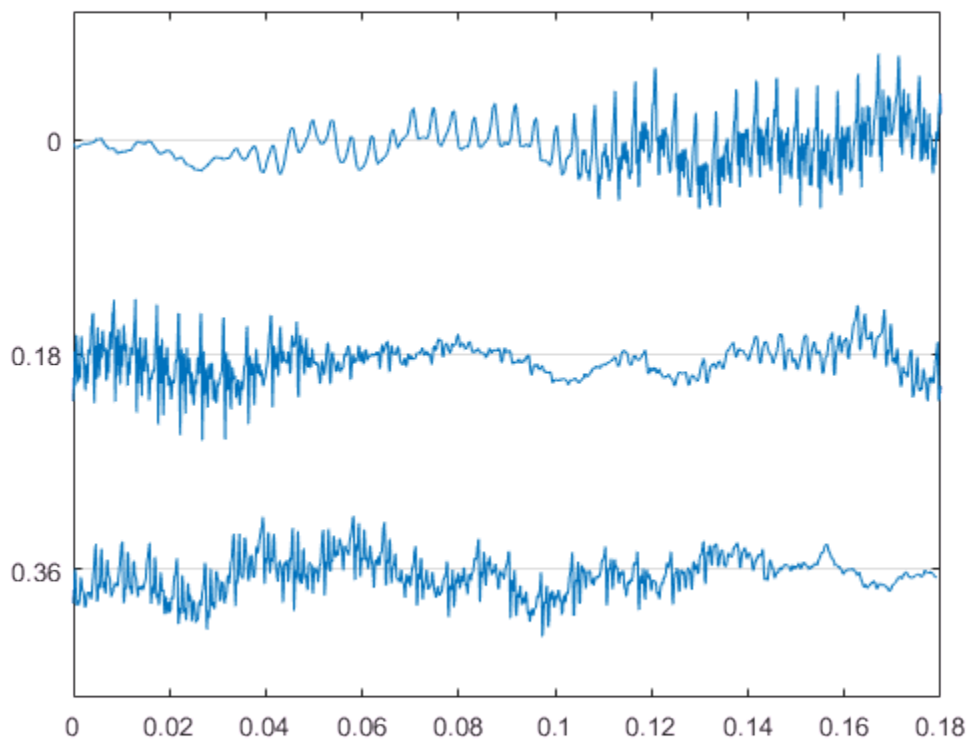

See Also

`plot` | `stem`

Introduced before R2006a

taylorwin

Taylor window

Syntax

```
w = taylorwin(n)
w = taylorwin(n,nbar)
w = taylorwin(n,nbar,sll)
```

Description

Taylor windows are similar to Chebyshev windows. Whereas a Chebyshev window has the narrowest possible mainlobe for a specified sidelobe level, a Taylor window allows you to make tradeoffs between the mainlobe width and the sidelobe level. The Taylor distribution avoids edge discontinuities, so Taylor window sidelobes decrease monotonically. Taylor window coefficients are not normalized. Taylor windows are typically used in radar applications, such as weighting synthetic aperture radar images and antenna design.

`w = taylorwin(n)` returns an n -point Taylor window in a column vector, w . The values in this vector are the window weights or coefficients.

`w = taylorwin(n,nbar)` returns an n -point Taylor window with `nbar` nearly constant-level sidelobes adjacent to the mainlobe. These sidelobes are “nearly constant-level” because some decay occurs in the transition region. `nbar` must be a positive integer. Its default value is 4.

`w = taylorwin(n,nbar,sll)` returns an n -point Taylor window with a maximum sidelobe level of `sll` dB relative to the mainlobe peak. `sll` must be negative. Its default value is -30 , which produces sidelobes with peaks 30 dB down from the mainlobe peak.

Examples

Taylor Window

Generate a 64-point Taylor window with four nearly constant-level sidelobes and a peak sidelobe level of -35 dB relative to the mainlobe peak. Visualize the result with `wvtool`.

```
w = taylorwin(64,4,-35);
wvtool(w)
```

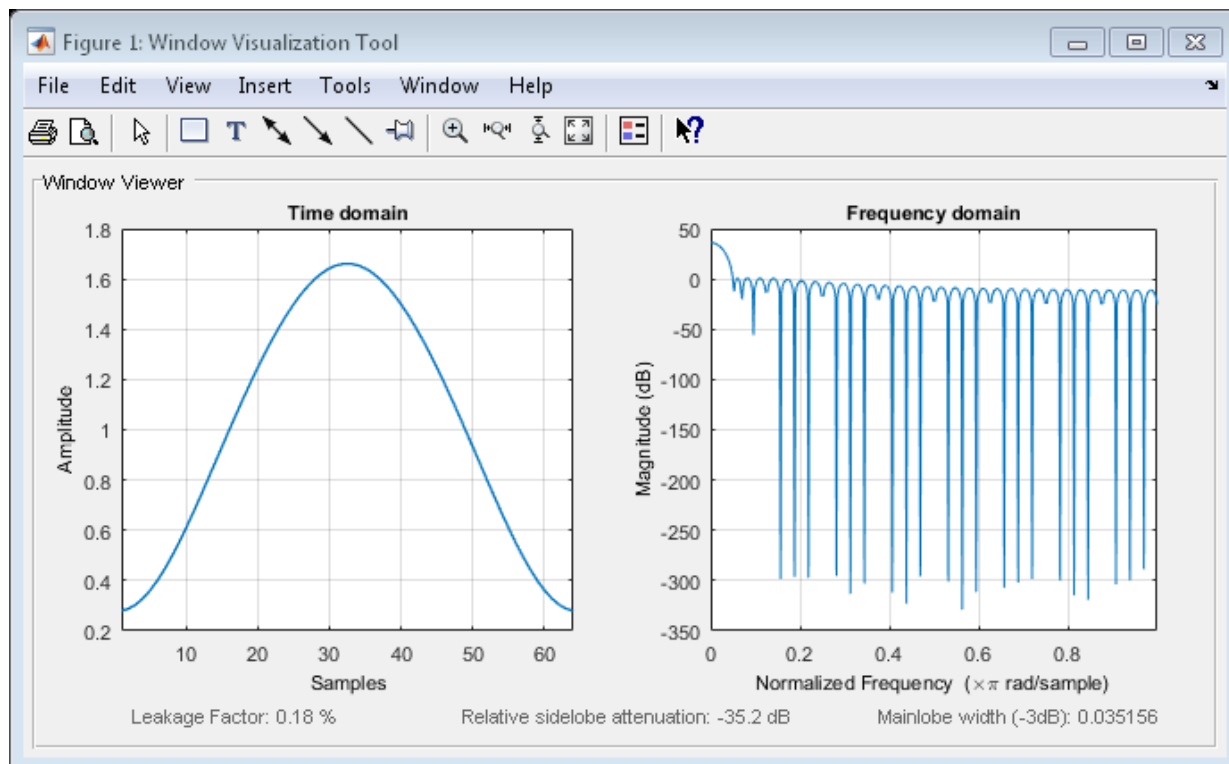

References

- [1] Carrara, Walter G., Ronald M. Majewski, and Ron S. Goodman. *Spotlight Synthetic Aperture Radar: Signal Processing Algorithms*. Boston: Artech House, 1995, Appendix D.2.
- [2] Brookner, Eli. *Practical Phased Array Antenna Systems*. Boston: Artech House, 1991.

Extended Capabilities

C/C++ Code Generation

Generate C and C++ code using MATLAB® Coder™.

Usage notes and limitations:

All inputs must be constant. Expressions or variables are allowed if their values do not change.

Introduced in R2006a

tachorpm

Extract RPM signal from tachometer pulses

Syntax

```
rpm = tachorpm(x,fs)
[rpm,t,tp] = tachorpm(x,fs)

[ ___ ] = tachorpm(x,fs,Name,Value)

tachorpm( ___ )
```

Description

`rpm = tachorpm(x,fs)` extracts a rotational speed signal, `rpm`, from a tachometer pulse signal vector, `x`, that has been sampled at a rate of `fs` Hz.

`[rpm,t,tp] = tachorpm(x,fs)` also returns the time vector, `t`, and the detected pulse locations, `tp`.

`[___] = tachorpm(x,fs,Name,Value)` specifies options using `Name,Value` pairs and any of the previous syntaxes.

`tachorpm(___)` with no output arguments plots the generated RPM signal and the tachometer signal with the detected pulses.

Examples

RPM Peak

Load a simulated tachometer signal sampled at 300 Hz.

```
load tacho
```

Compute and visualize the RPM signal using `tachorpm` with the default values.

```
tachorpm(Yn, fs)
```

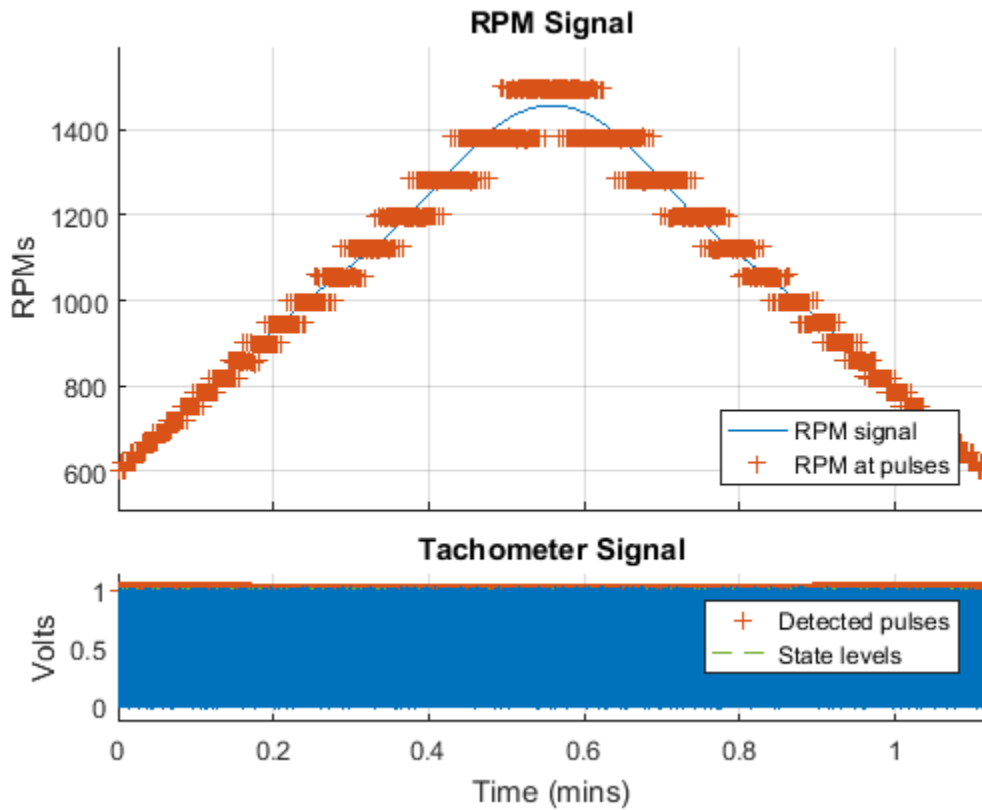

Increase the number of fit points to capture the RPM peak. Too many points result in overfitting. Verify this result by zooming in on the area around the peak.

```
tachorpm(Yn, fs, 'FitPoints', 600)
```

```
axis([0.47 0.65 1320 1570])
```

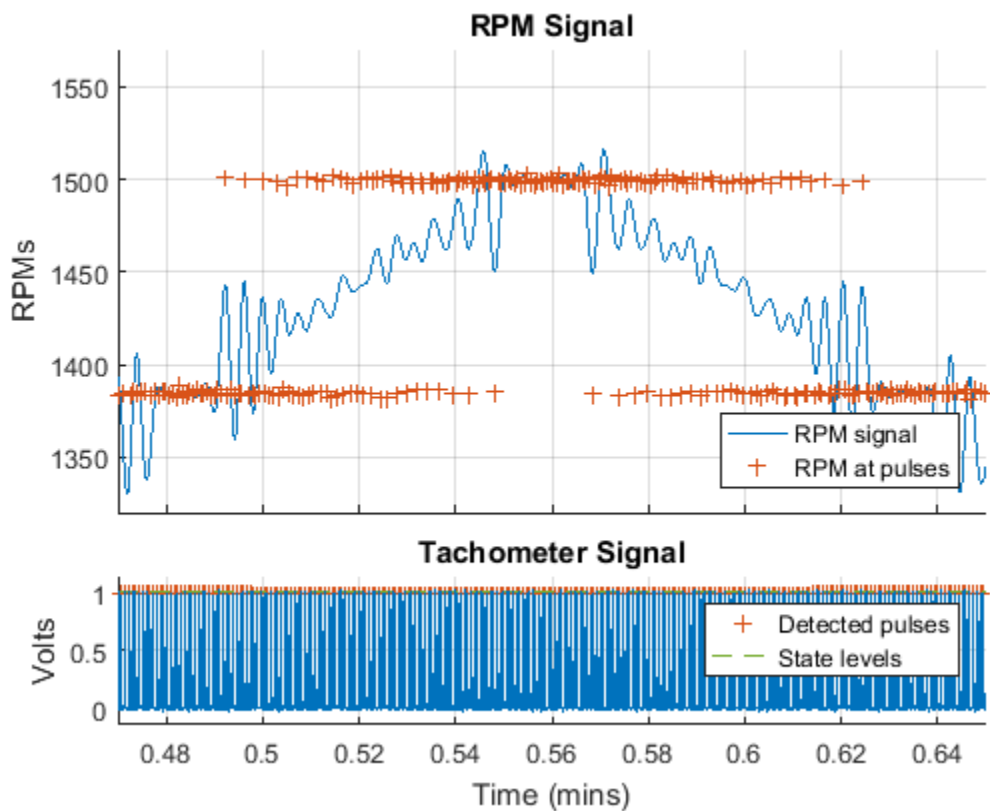

Choose a moderate number of points to obtain a better result.

```
tachorpm(Yn, fs, 'FitPoints', 100)
```

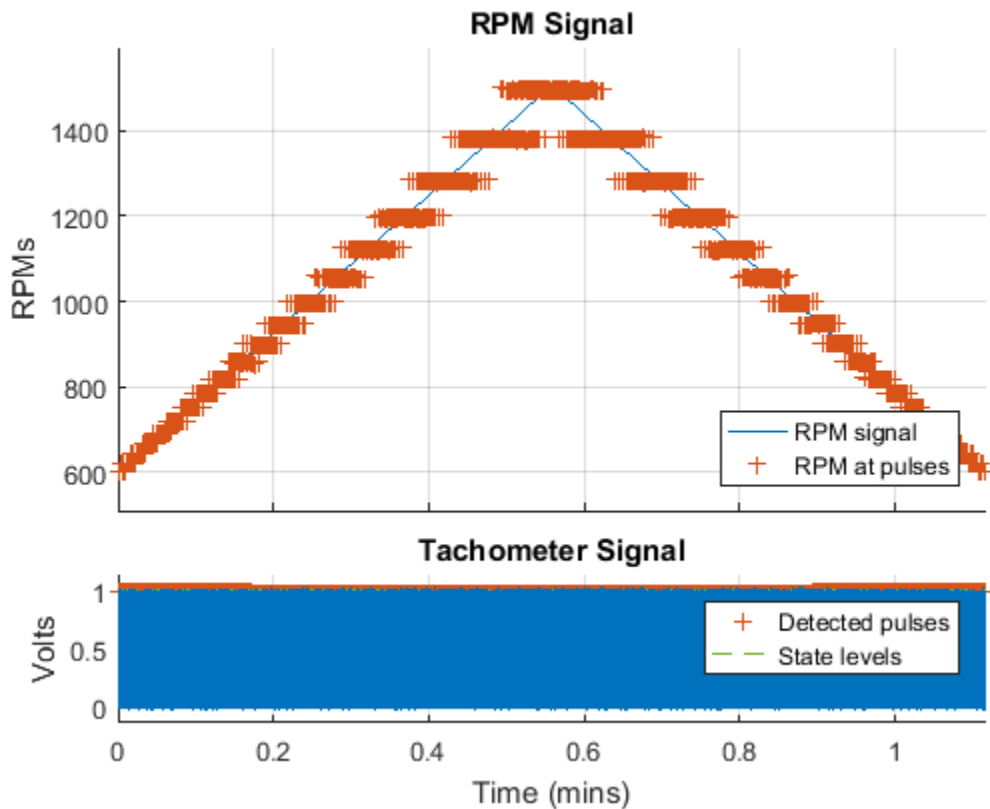

Add white Gaussian noise to the tachometer signal. The default pulse-finding mechanism misses pulses and returns a jagged signal profile. Verify this result by zooming in on a two-second time interval.

```
rng default
wgn = randn(size(Yn))/10;
Yn = Yn+wgn;

[rpm,t,tp] = tachorpm(Yn,fs,'FitPoints',100);

figure
plot(t,Yn,tp,mean(interp1(t,Yn,tp))*ones(size(tp)),'+')
hold on
sl = statelevels(Yn);
```

```
plot(t,s1(1)*ones(size(t)),t,s1(2)*ones(size(t)))
hold off
xlim([9 10])
```

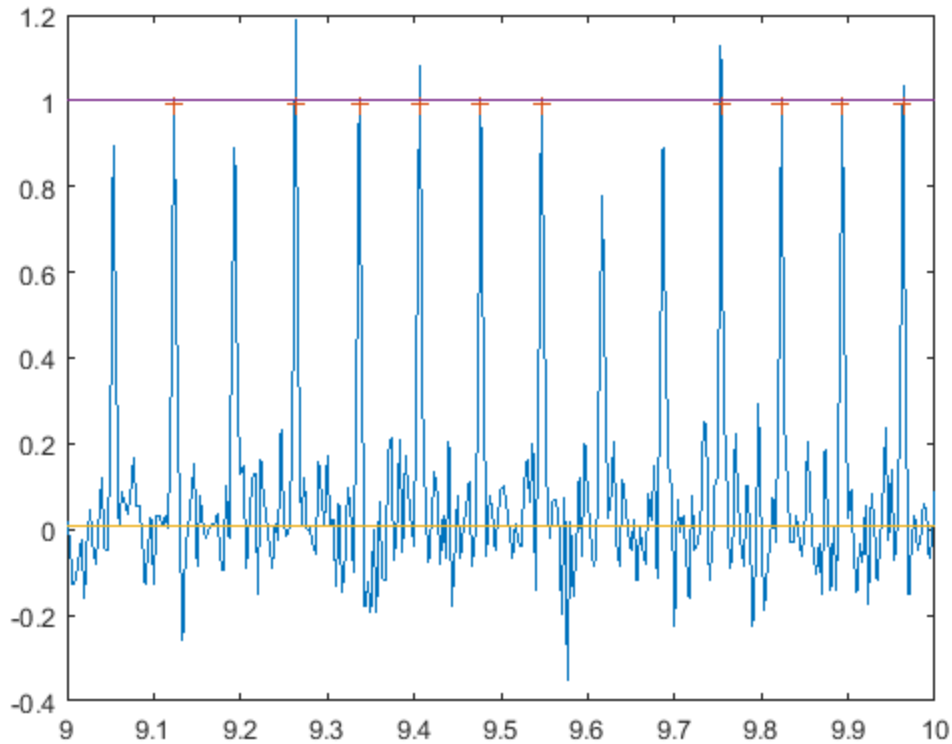

Adjust the state levels to improve the pulse finding.

```
s1 = [0 0.75];

[rpm,t,tp] = tachorpm(Yn,fs,'FitPoints',100,'StateLevels',s1);

plot(t,Yn,tp,mean(interp1(t,Yn,tp))*ones(size(tp)),'+')
hold on
plot(t,s1(1)*ones(size(t)),t,s1(2)*ones(size(t)))
hold off
```

```
xlim([9 10])
```

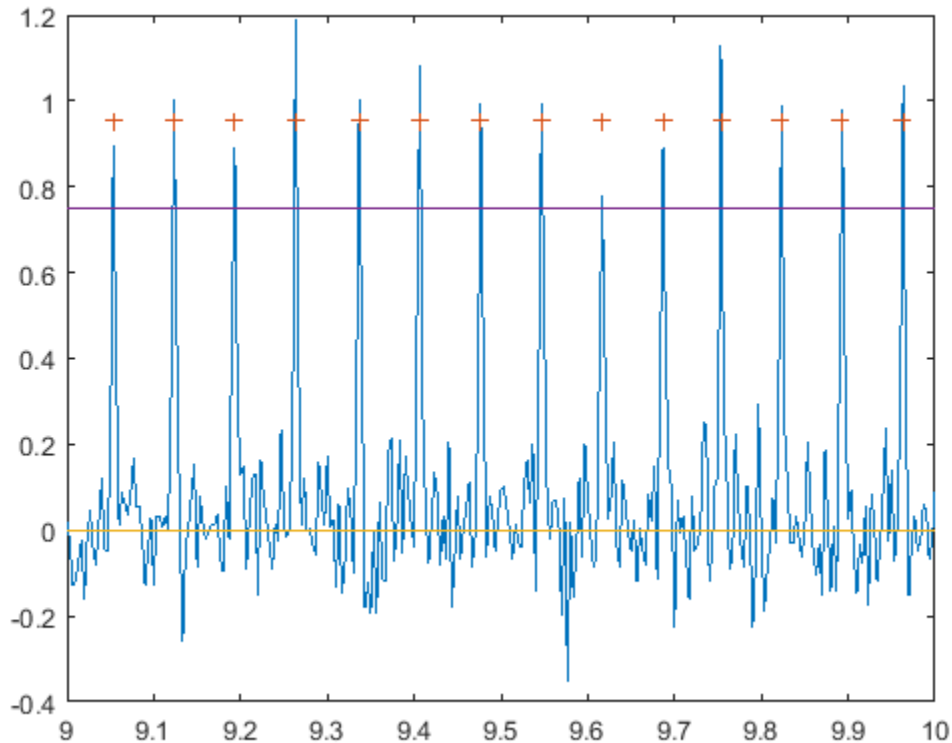

Input Arguments

x — Tachometer pulse signal

vector

Tachometer pulse signal, specified as a row or column vector.

Example: `double(chirp((-1.5:1/2e2:1.5),14,1.1,8,'quadratic')>0.98)` resembles a tachometer signal, sampled for three seconds at 200 Hz, and obtained during a quadratic run-up/coast-down test.

Data Types: `double` | `single`

fs — Sample rate

positive scalar

Sample rate, specified as a positive scalar expressed in Hz.

Data Types: `double` | `single`

Name-Value Pair Arguments

Specify optional comma-separated pairs of `Name`, `Value` arguments. `Name` is the argument name and `Value` is the corresponding value. `Name` must appear inside single quotes (' '). You can specify several name and value pair arguments in any order as `Name1`, `Value1`, ..., `NameN`, `ValueN`.

Example: `'PulsesPerRev',3,'OutputFs',1e3` specifies that there are three tachometer pulses per revolution and that the returned RPM signal is to be sampled at 1 kHz.

'PulsesPerRev' — Number of tachometer pulses per revolution

1 (default) | real scalar

Number of tachometer pulses per revolution, specified as the comma-separated pair consisting of `'PulsesPerRev'` and a real scalar.

Data Types: `double` | `single`

'StateLevels' — State levels used to identify pulses

two-element real vector

State levels used to identify pulses, specified as the comma-separated pair consisting of `'StateLevels'` and a two-element real vector. The first element of the vector corresponds to the low-state level and the second element corresponds to the high-state level. Choose the state levels so that all pulse edges cross within 10% of both of them. If this option is not specified, then `tachorpm` computes the levels automatically using the histogram method, as in the `statelevels` function.

Data Types: `double` | `single`

'OutputFs' — Output sample rate

fs (default) | real scalar

Output sample rate, specified as the comma-separated pair consisting of 'OutputFs' and a real scalar.

Data Types: double | single

'FitType' — Fitting method

'smooth' (default) | 'linear'

Fitting method, specified as the comma-separated pair consisting of 'FitType' and one of either 'smooth' or 'linear'.

- 'smooth' — Fit a least-squares B-spline to the pulse RPM values.
- 'linear' — Interpolate linearly between pulse RPM values.

Data Types: single | double

'FitPoints' — B-spline breakpoints

10 (default) | real scalar

B-spline breakpoints, specified as the comma-separated pair consisting of 'FitPoints' and a real scalar. The number of breakpoints is a trade-off between curve smoothness and closeness to the underlying data. Choosing too many breakpoints can result in overfitting. This argument is ignored if 'FitType' is set to 'linear'.

Data Types: double | single

Output Arguments

rpm — Rotational speeds

vector of positive values

Rotational speeds, returned as a vector of positive values expressed in revolutions per minute. rpm has the same length as x.

t — Time vector

vector of positive values

Time vector, returned as a vector of positive values expressed in seconds.

tp — Pulse locations

vector of positive values

Pulse locations, returned as a vector of positive values expressed in seconds.

Algorithms

The `tachorpm` function performs these steps:

- 1 Uses `statelevels` to determine the low and high states of the tachometer signal.
- 2 Uses `risetime` and `falltime` to find the times at which each pulse starts and ends. It then averages these readings to locate the time of each pulse.
- 3 Uses `diff` to determine the time intervals between pulse centers and computes the RPM values at the interval midpoints using $RPM = 60 / \Delta t$.
- 4 If `'FitType'` is specified as `'smooth'`, then the function performs least-squares fitting using splines. If `'FitType'` is specified as `'linear'`, then the function performs linear interpolation using `interp1`.

References

- [1] Brandt, Anders. *Noise and Vibration Analysis: Signal Analysis and Experimental Procedures*. Chichester, UK: John Wiley & Sons, 2011.
- [2] Vold, Håvard, and Jan Leuridan. “High Resolution Order Tracking at Extreme Slew Rates Using Kalman Tracking Filters.” *Shock and Vibration*. Vol. 2, 1995, pp.507–515.

See Also

See Also

`orderspectrum` | `ordertrack` | `orderwaveform` | `rpmfreqmap` | `rpmordermap` | `statelevels`

Introduced in R2016b

tf

Convert digital filter to transfer function

Syntax

```
[num,den] = tf(d)
```

Description

[num,den] = tf(d) converts a digital filter, d, to numerator and denominator vectors.

Examples

Highpass Filter Transfer Function

Design a 6th-order highpass FIR filter with a passband frequency of 75 kHz and a passband ripple of 0.2 dB. Specify a sample rate of 200 kHz. Compute the coefficients of the equivalent transfer function.

```
hpFilt = designfilt('highpassfir','FilterOrder',6, ...  
    'PassbandFrequency',75e3,'PassbandRipple',0.2, ...  
    'SampleRate',200e3);
```

```
[b,a] = tf(hpFilt)
```

b =

```
    0.0003   -0.0019    0.0048   -0.0064    0.0048   -0.0019    0.0003
```

a =

```
    1.0000    4.0580    7.5656    8.1243    5.2561    1.9348    0.3164
```

Input Arguments

d — Digital filter

`digitalFilter` object

Digital filter, specified as a `digitalFilter` object. Use `designfilt` to generate a digital filter based on frequency-response specifications.

Example: `d = designfilt('lowpassiir','FilterOrder',3,'HalfPowerFrequency',0.5)` specifies a third-order Butterworth filter with normalized 3-dB frequency 0.5π rad/sample.

Output Arguments

num — Numerator coefficients

row vector

Numerator coefficients, returned as a row vector.

Data Types: `double`

den — Denominator coefficients

row vector

Denominator coefficients, returned as a row vector.

Data Types: `double`

See Also

See Also

`designfilt` | `digitalFilter` | `ss` | `zpk`

Introduced in R2014a

tf2latc

Convert transfer function filter parameters to lattice filter form

Syntax

```
[k,v] = tf2latc(b,a)
k = tf2latc(1,a)
[k,v] = tf2latc(1,a)
k = tf2latc(b)
k = tf2latc(b,'phase')
```

Description

`[k,v] = tf2latc(b,a)` finds the lattice parameters `k` and the ladder parameters `v` for an IIR (ARMA) lattice-ladder filter, normalized by `a(1)`. Note that an error is generated if one or more of the lattice parameters are exactly equal to 1.

`k = tf2latc(1,a)` finds the lattice parameters `k` for an IIR all-pole (AR) lattice filter.

`[k,v] = tf2latc(1,a)` returns the scalar ladder coefficient at the correct position in vector `v`. All other elements of `v` are zero.

`k = tf2latc(b)` finds the lattice parameters `k` for an FIR (MA) lattice filter, normalized by `b(1)`.

`k = tf2latc(b,'phase')` specifies the type of FIR (MA) lattice filter, where `'phase'` is

- `'max'`, for a maximum phase filter.
- `'min'`, for a minimum phase filter.

See Also

latc2tf | tf2sos | tf2ss | tf2zp | tf2zpk | latcfilt

Introduced before R2006a

tf2sos

Convert digital filter transfer function data to second-order sections form

Syntax

```
[sos,g] = tf2sos(b,a)
[sos,g] = tf2sos(b,a,'order')
[sos,g] = tf2sos(b,a,'order','scale')
sos = tf2sos(...)
```

Description

tf2sos converts a transfer function representation of a given digital filter to an equivalent second-order section representation.

[sos,g] = tf2sos(b,a) finds a matrix **sos** in second-order section form with gain **g** that is equivalent to the digital filter represented by transfer function coefficient vectors **a** and **b**.

$$H(z) = \frac{B(z)}{A(z)} = \frac{b_1 + b_2z^{-1} + \dots + b_{n+1}z^{-n}}{a_1 + a_2z^{-1} + \dots + a_{m+1}z^{-m}}$$

sos is an L -by-6 matrix

$$\text{sos} = \begin{bmatrix} b_{01} & b_{11} & b_{21} & 1 & a_{11} & a_{21} \\ b_{02} & b_{12} & b_{22} & 1 & a_{12} & a_{22} \\ \vdots & \vdots & \vdots & \vdots & \vdots & \vdots \\ b_{0L} & b_{1L} & b_{2L} & 1 & a_{1L} & a_{2L} \end{bmatrix}$$

whose rows contain the numerator and denominator coefficients b_{ik} and a_{ik} of the second-order sections of $H(z)$.

$$H(z) = g \prod_{k=1}^L H_k(z) = g \prod_{k=1}^L \frac{b_{0k} + b_{1k}z^{-1} + b_{2k}z^{-2}}{1 + a_{1k}z^{-1} + a_{2k}z^{-2}}$$

`[sos,g] = tf2sos(b,a,'order')` specifies the order of the rows in `sos`, where `'order'` is

- `'down'`, to order the sections so the first row of `sos` contains the poles closest to the unit circle
- `'up'`, to order the sections so the first row of `sos` contains the poles farthest from the unit circle (default)

`[sos,g] = tf2sos(b,a,'order','scale')` specifies the desired scaling of the gain and numerator coefficients of all second-order sections, where `'scale'` is:

- `'none'`, to apply no scaling (default)
- `'inf'`, to apply infinity-norm scaling
- `'two'`, to apply 2-norm scaling

Using infinity-norm scaling in conjunction with `up`-ordering minimizes the probability of overflow in the realization. Using 2-norm scaling in conjunction with `down`-ordering minimizes the peak round-off noise.

Note Infinity-norm and 2-norm scaling are appropriate only for direct-form II implementations.

`sos = tf2sos(...)` embeds the overall system gain, `g`, in the first section, $H_1(z)$, so that

$$H(z) = \prod_{k=1}^L H_k(z)$$

Note Embedding the gain in the first section when scaling a direct-form II structure is not recommended and may result in erratic scaling. To avoid embedding the gain, use `ss2sos` with two outputs.

Examples

Second-Order Section Implementation of a Butterworth Filter

Design a Butterworth 4th-order lowpass filter using the function `butter`. Specify the cutoff frequency as half the Nyquist frequency. Implement the filter as second-order sections. Verify that the two representations are identical by comparing their numerators and denominators.

```
[nm,dn] = butter(4,0.5);
[ss,gn] = tf2sos(nm,dn);
numers = [conv(ss(1,1:3),ss(2,1:3))*gn;nm]

numers =

    0.0940    0.3759    0.5639    0.3759    0.0940
    0.0940    0.3759    0.5639    0.3759    0.0940

denoms = [conv(ss(1,4:6),ss(2,4:6)) ;dn]

denoms =

    1.0000    0.0000    0.4860    0.0000    0.0177
    1.0000    0.0000    0.4860    0.0000    0.0177
```

Algorithms

`tf2sos` uses a four-step algorithm to determine the second-order section representation for an input transfer function system:

- 1 It finds the poles and zeros of the system given by `b` and `a`.
- 2 It uses the function `zp2sos`, which first groups the zeros and poles into complex conjugate pairs using the `cplxpair` function. `zp2sos` then forms the second-order sections by matching the pole and zero pairs according to the following rules:
 - a** Match the poles closest to the unit circle with the zeros closest to those poles.
 - b** Match the poles next closest to the unit circle with the zeros closest to those poles.

- c Continue until all of the poles and zeros are matched.

tf2sos groups real poles into sections with the real poles closest to them in absolute value. The same rule holds for real zeros.

- 3 It orders the sections according to the proximity of the pole pairs to the unit circle. tf2sos normally orders the sections with poles closest to the unit circle last in the cascade. You can tell tf2sos to order the sections in the reverse order by specifying the 'down' flag.
- 4 tf2sos scales the sections by the norm specified in the 'scale' argument. For arbitrary $H(\omega)$, the scaling is defined by

$$\|H\|_p = \left[\frac{1}{2\pi} \int_0^{2\pi} |H(\omega)|^p d\omega \right]^{1/p}$$

where p can be either ∞ or 2. See the references for details on the scaling. This scaling is an attempt to minimize overflow or peak round-off noise in fixed point filter implementations.

References

- [1] Jackson, L. B. *Digital Filters and Signal Processing*. 3rd ed. Boston: Kluwer Academic Publishers, 1996, chap. 11.
- [2] Mitra, S. K. *Digital Signal Processing: A Computer-Based Approach*. New York: McGraw-Hill, 1998, chap. 9.
- [3] Vaidyanathan, P. P. "Robust Digital Filter Structures." *Handbook for Digital Signal Processing* (S. K. Mitra and J. F. Kaiser, eds.). New York: John Wiley & Sons, 1993, chap. 7.

See Also

cplxpair | sos2tf | ss2sos | tf2ss | tf2zp | tf2zpk | zp2sos

Introduced before R2006a

tf2ss

Convert transfer function filter parameters to state-space form

Syntax

`[A,B,C,D] = tf2ss(b,a)`

Description

`tf2ss` converts the parameters of a transfer function representation of a given system to those of an equivalent state-space representation.

`[A,B,C,D] = tf2ss(b,a)` returns the **A**, **B**, **C**, and **D** matrices of a state space representation for the single-input transfer function

$$H(s) = \frac{B(s)}{A(s)} = \frac{b_1s^{n-1} + \dots + b_{n-1}s + b_n}{a_1s^{m-1} + \dots + a_{m-1}s + a_m} = C(sI - A)^{-1}B + D$$

in controller canonical form

$$\begin{aligned}\dot{x} &= Ax + Bu \\ y &= Cx + Du\end{aligned}$$

The input vector **a** contains the denominator coefficients in descending powers of *s*. The rows of the matrix **b** contain the vectors of numerator coefficients (each row corresponds to an output). In the discrete-time case, you must supply **b** and **a** to correspond to the numerator and denominator polynomials with coefficients in descending powers of *z*.

For discrete-time systems you must make **b** have the same number of columns as the length of **a**. You can do this by padding each numerator represented in **b** (and possibly the denominator represented in the vector **a**) with trailing zeros. You can use the function `eqtflength` to accomplish this if **b** and **a** are vectors of unequal lengths.

The `tf2ss` function is part of the standard MATLAB language.

Note There is disagreement in the literature on naming conventions for the canonical forms. It is easy, however, to generate similarity transformations that convert these results to other forms.

Examples

State-Space Representation of Transfer Function

Consider the system described by the transfer function

$$H(s) = \frac{\begin{bmatrix} 2s + 3 \\ s^2 + 2s + 1 \end{bmatrix}}{s^2 + 0.4s + 1}.$$

Convert it to state-space form using `tf2ss`.

```
b = [0 2 3; 1 2 1];
a = [1 0.4 1];
[A,B,C,D] = tf2ss(b,a)
```

A =

```
-0.4000   -1.0000
 1.0000         0
```

B =

```
 1
 0
```

C =

```
 2.0000   3.0000
 1.6000         0
```

D =

```
 0
```

1

Mass-Spring System

A one-dimensional discrete-time oscillating system consists of a unit mass, m , attached to a wall by a spring of unit elastic constant. A sensor samples the acceleration, a , of the mass at $F_s = 5$ Hz.

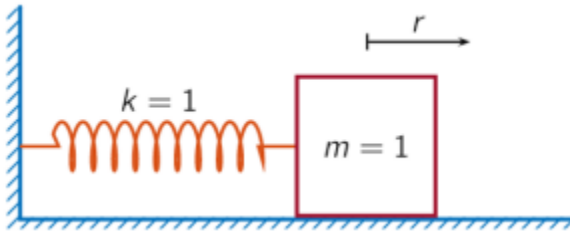

Generate 50 time samples. Define the sampling interval $\Delta t = 1/F_s$.

```
Fs = 5;
dt = 1/Fs;
N = 50;
t = dt*(0:N-1);
u = [1 zeros(1,N-1)];
```

The transfer function of the system has an analytic expression:

$$H(z) = \frac{1 - z^{-1}(1 + \cos \Delta t) + z^{-2} \cos \Delta t}{1 - 2z^{-1} \cos \Delta t + z^{-2}}$$

The system is excited with a unit impulse in the positive direction. Compute the time evolution of the system using the transfer function. Plot the response.

```
bf = [1 -(1+cos(dt)) cos(dt)];
af = [1 -2*cos(dt) 1];
yf = filter(bf,af,u);

stem(t,yf, 'o')
```

```
xlabel('t')
```

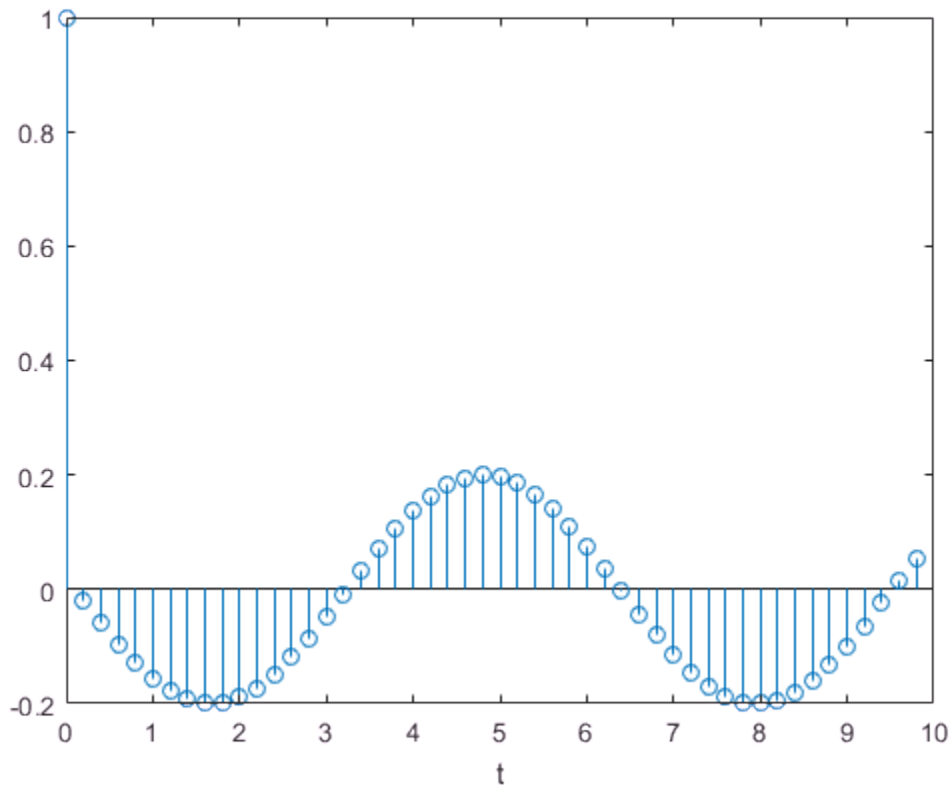

Find the state-space representation of the system. Compute the time evolution starting from an all-zero initial state. Compare it to the transfer-function prediction.

```
[A,B,C,D] = tf2ss(bf,af);
```

```
x = [0;0];
for k = 1:N
    y(k) = C*x + D*u(k);
    x = A*x + B*u(k);
end
```

```
hold on
```

```
stem(t,y,'*')  
hold off  
legend('tf','ss')
```

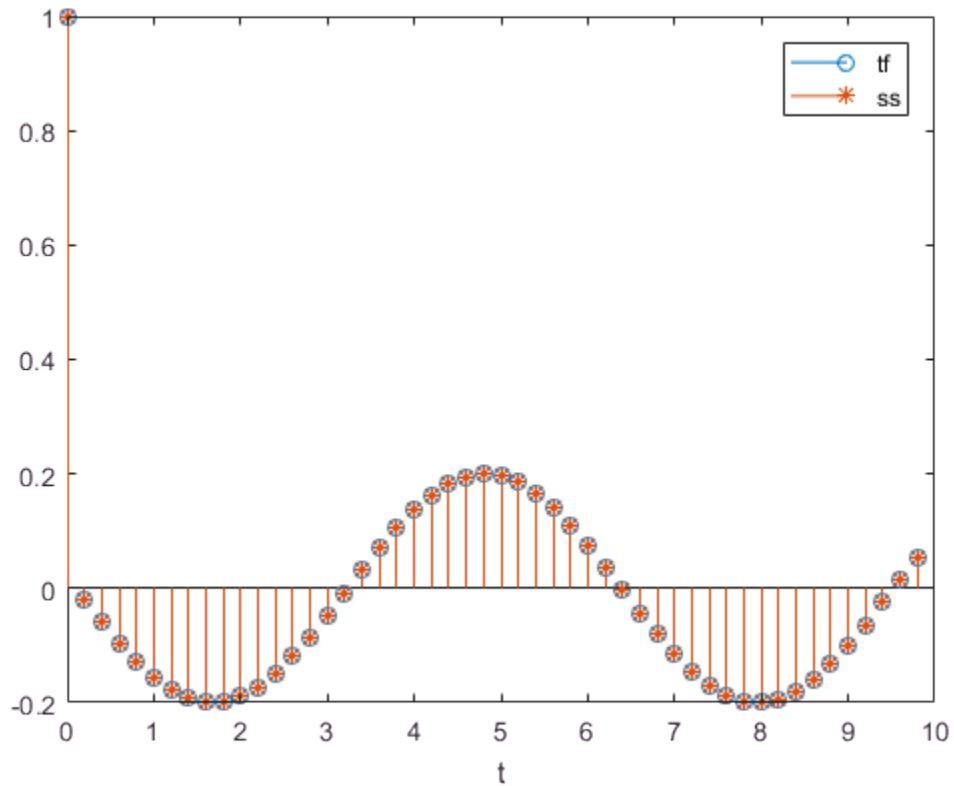

See Also

[sos2ss](#) | [ss2tf](#) | [tf2sos](#) | [tf2zp](#) | [tf2zpk](#) | [zp2ss](#)

Introduced before R2006a

tf2zp

Convert transfer function filter parameters to zero-pole-gain form

Syntax

`[z,p,k] = tf2zp(b,a)`

Description

`tf2zp` finds the zeros, poles, and gains of a continuous-time transfer function.

Note You should use `tf2zp` when working with positive powers ($s^2 + s + 1$), such as in continuous-time transfer functions. A similar function, `tf2zpk`, is more useful when working with transfer functions expressed in inverse powers ($1 + z^{-1} + z^{-2}$), which is how transfer functions are usually expressed in DSP.

`[z,p,k] = tf2zp(b,a)` finds the matrix of zeros `z`, the vector of poles `p`, and the associated vector of gains `k` from the transfer function parameters `b` and `a`:

- The numerator polynomials are represented as columns of the matrix `b`.
- The denominator polynomial is represented in the vector `a`.

Given a SIMO continuous-time system in polynomial transfer function form

$$H(s) = \frac{B(s)}{A(s)} = \frac{b_1 s^{n-1} + \dots + b_{n-1} s + b_n}{a_1 s^{m-1} + \dots + a_{m-1} s + a_m}$$

you can use the output of `tf2zp` to produce the single-input, multi-output (SIMO) factored transfer function form

$$H(s) = \frac{Z(s)}{P(s)} = k \frac{(s - z_1)(s - z_2) \dots (s - z_m)}{(s - p_1)(s - p_2) \dots (s - p_n)}$$

The following describes the input and output arguments for `tf2zp`:

- The vector **a** specifies the coefficients of the denominator polynomial $A(s)$ (or $A(z)$) in descending powers of s (z^{-1}).
- The i th row of the matrix **b** represents the coefficients of the i th numerator polynomial (the i th row of $B(s)$ or $B(z)$). Specify as many rows of **b** as there are outputs.
- For continuous-time systems, choose the number nb of columns of **b** to be less than or equal to the length na of the vector **a**.
- For discrete-time systems, choose the number nb of columns of **b** to be equal to the length na of the vector **a**. You can use the function `eqtflength` to provide equal length vectors in the case that **b** and **a** are vectors of unequal lengths. Otherwise, pad the numerators in the matrix **b** (and, possibly, the denominator vector **a**) with zeros.
- The zero locations are returned in the columns of the matrix **z**, with as many columns as there are rows in **b**.
- The pole locations are returned in the column vector **p** and the gains for each numerator transfer function in the vector **k**.

The `tf2zp` function is part of the standard MATLAB language.

Examples

Zeros, Poles, and Gain of a Continuous-Time System

Generate a system with the following transfer function.

$$H(s) = \frac{2s^2 + 3s}{s^2 + \frac{1}{\sqrt{2}}s + \frac{1}{4}} = \frac{2(s - 0)(s - (-\frac{3}{2}))}{(s - \frac{-1}{2\sqrt{2}}(1 - j))(s - \frac{-1}{2\sqrt{2}}(1 + j))}$$

Find the zeros, poles, and gain of the system. Use `eqtflength` to ensure the numerator and denominator have the same length. Plot the poles and zeros to verify that they are in the expected locations.

```
b = [2 3];
a = [1 1/sqrt(2) 1/4];
fvtool(b,a,'polezero')
[b,a] = eqtflength(b,a);
[z,p,k] = tf2zp(b,a)
```

z =

0
-1.5000

p =

-0.3536 + 0.3536i
-0.3536 - 0.3536i

k = 2

```
text(real(z)+.1,imag(z), 'Zero')  
text(real(p)+.1,imag(p), 'Pole')
```

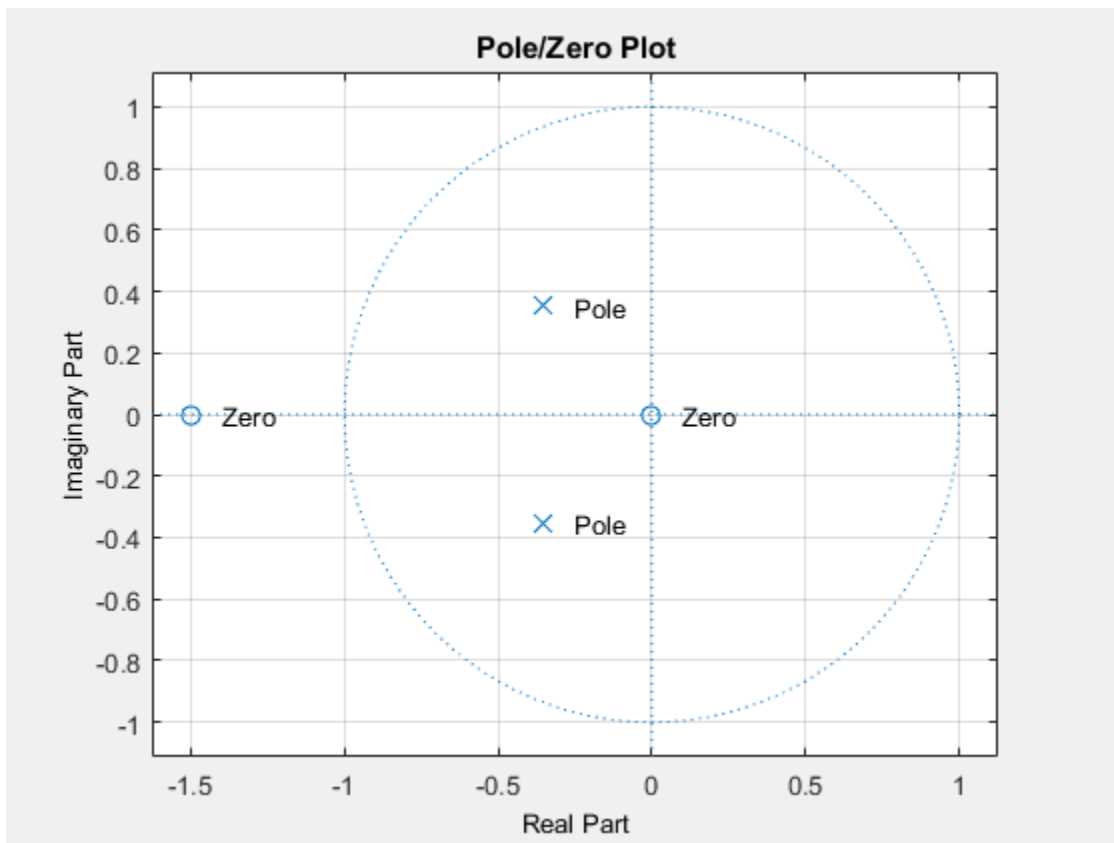

See Also

sos2zp | ss2zp | tf2sos | tf2ss | tf2zpk | zp2tf

Introduced before R2006a

tf2zpk

Convert transfer function filter parameters to zero-pole-gain form

Syntax

`[z,p,k] = tf2zpk(b,a)`

Description

tf2zpk finds the zeros, poles, and gains of a discrete-time transfer function.

Note You should use `tf2zpk` when working with transfer functions expressed in inverse powers ($1 + z^{-1} + z^{-2}$), which is how transfer functions are usually expressed in DSP. A similar function, `tf2zp`, is more useful for working with positive powers ($s^2 + s + 1$), such as in continuous-time transfer functions.

`[z,p,k] = tf2zpk(b,a)` finds the matrix of zeros `z`, the vector of poles `p`, and the associated vector of gains `k` from the transfer function parameters `b` and `a`:

- The numerator polynomials are represented as columns of the matrix `b`.
- The denominator polynomial is represented in the vector `a`.

Given a single-input, multiple output (SIMO) discrete-time system in polynomial transfer function form

$$H(z) = \frac{B(z)}{A(z)} = \frac{b_1 + b_2 z^{-1} \dots + b_{n-1} z^{-n} + b_n z^{-n-1}}{a_1 + a_2 z^{-1} \dots + a_{m-1} z^{-m} + a_m z^{-m-1}}$$

you can use the output of `tf2zpk` to produce the single-input, multioutput (SIMO) factored transfer function form

$$H(z) = \frac{Z(z)}{P(z)} = k \frac{(z - z_1)(z - z_2) \dots (z - z_m)}{(z - p_1)(z - p_2) \dots (z - p_n)}$$

The following describes the input and output arguments for `tf2zpk`:

- The vector **a** specifies the coefficients of the denominator polynomial $A(z)$ in descending powers of z .
- The i th row of the matrix **b** represents the coefficients of the i th numerator polynomial (the i th row of $B(s)$ or $B(z)$). Specify as many rows of **b** as there are outputs.
- The zero locations are returned in the columns of the matrix **z**, with as many columns as there are rows in **b**.
- The pole locations are returned in the column vector **p** and the gains for each numerator transfer function in the vector **k**.

Examples

Poles, Zeros, and Gain of an IIR Filter

Design a 3rd-order Butterworth filter with normalized cutoff frequency 0.4π rad/sample. Find the poles, zeros, and gain of the filter. Plot them to verify that they are where expected.

```
[b,a] = butter(3,.4);  
fvtool(b,a,'polezero')  
[z,p,k] = tf2zpk(b,a)
```

```
z =  
-1.0000 + 0.0000i  
-1.0000 - 0.0000i  
-1.0000 + 0.0000i
```

```
p =  
0.2094 + 0.5582i  
0.2094 - 0.5582i  
0.1584 + 0.0000i
```

```
k = 0.0985
```

```
text(real(z)-0.1,imag(z)-0.1,'Zeros','color',[0 0.4 0])  
text(real(p)-0.1,imag(p)-0.1,'Poles','color',[0.6 0 0])
```

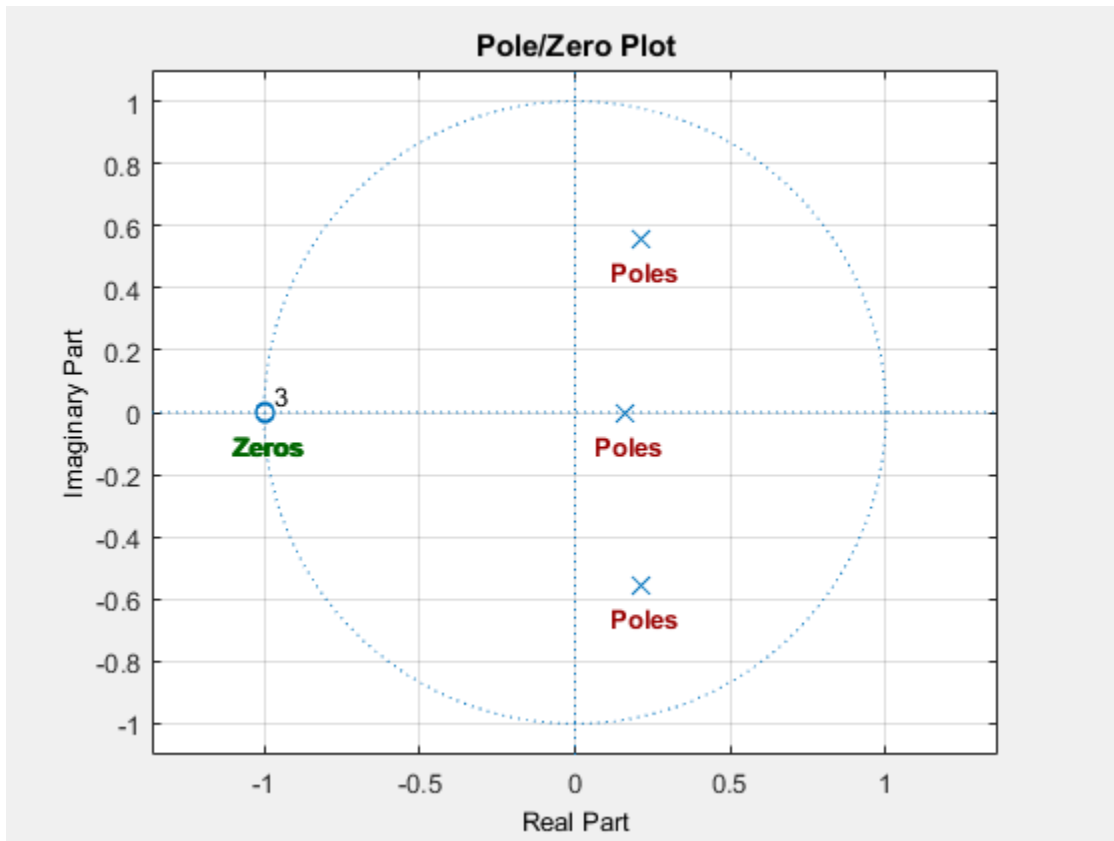

See Also

[sos2zp](#) | [ss2zp](#) | [tf2sos](#) | [tf2ss](#) | [tf2zp](#) | [zp2tf](#)

Introduced before R2006a

tfestimate

Transfer function estimate

Syntax

```
txy = tfestimate(x,y)
txy = tfestimate(x,y>window)
txy = tfestimate(x,y>window,noverlap)
txy = tfestimate(x,y>window,noverlap,nfft)

txy = tfestimate( ____, 'mimo' )

[txy,w] = tfestimate( ____ )
[txy,f] = tfestimate( ____, fs)

[txy,w] = tfestimate(x,y>window,noverlap,w)
[txy,f] = tfestimate(x,y>window,noverlap,f,fs)

[ ____ ] = tfestimate(x,y, ____, freqrange)

[ ____ ] = tfestimate( ____, 'Estimator', est)

tfestimate( ____ )
```

Description

`txy = tfestimate(x,y)` finds a transfer function estimate, `txy`, given an input signal, `x`, and an output signal, `y`.

- If `x` and `y` are both vectors, they must have the same length.
- If one of the signals is a matrix and the other is a vector, then the length of the vector must equal the number of rows in the matrix. The function expands the vector and returns a matrix of column-by-column transfer function estimates.
- If `x` and `y` are matrices with the same number of rows but different numbers of columns, then `txy` is a multi-input/multi-output (MIMO) transfer function that

combines all input and output signals. `txy` is a three-dimensional array. If `x` has m columns and `y` has n columns, then `txy` has n columns and m pages. See “Transfer Function” on page 1-2389 for more information.

- If `x` and `y` are matrices of equal size, then `tfestimate` operates column-wise:
`txy(:,n) = tfestimate(x(:,n),y(:,n))`. To obtain a MIMO estimate, append 'mimo' to the argument list.

`txy = tfestimate(x,y>window)` uses `window` to divide `x` and `y` into segments and perform windowing.

`txy = tfestimate(x,y>window,noverlap)` uses `noverlap` samples of overlap between adjoining segments.

`txy = tfestimate(x,y>window,noverlap,nfft)` uses `nfft` sampling points to calculate the discrete Fourier transform.

`txy = tfestimate(____, 'mimo')` computes a MIMO transfer function for matrix inputs. This syntax can include any combination of input arguments from previous syntaxes.

`[txy,w] = tfestimate(____)` returns a vector of normalized frequencies, `w`, at which the transfer function is estimated.

`[txy,f] = tfestimate(____, fs)` returns a vector of frequencies, `f`, expressed in terms of the sample rate, `fs`, at which the transfer function is estimated. `fs` must be the sixth numeric input to `tfestimate`. To input a sample rate and still use the default values of the preceding optional arguments, specify these arguments as empty, `[]`.

`[txy,w] = tfestimate(x,y>window,noverlap,w)` returns the transfer function estimate at the normalized frequencies specified in `w`.

`[txy,f] = tfestimate(x,y>window,noverlap,f,fs)` returns the transfer function estimate at the frequencies specified in `f`.

`[____] = tfestimate(x,y, ____, freqrange)` returns the transfer function estimate over the frequency range specified by `freqrange`. Valid options for `freqrange` are 'onesided', 'twosided', and 'centered'.

`[____] = tfestimate(____, 'Estimator', est)` estimates transfer functions using the estimator `est`. Valid options for `est` are 'H1' and 'H2'.

`tfestimate(____)` with no output arguments plots the transfer function estimate in the current figure window.

Examples

Transfer Function Between Two Sequences

Compute and plot the transfer function estimate between two sequences, `x` and `y`. The sequence `x` consists of white Gaussian noise. `y` results from filtering `x` with a 30th-order lowpass filter with normalized cutoff frequency 0.2π rad/sample. Use a rectangular window to design the filter. Specify a sample rate of 500 Hz and a Hamming window of length 1024 for the transfer function estimate.

```
h = fir1(30,0.2,rectwin(31));  
x = randn(16384,1);  
y = filter(h,1,x);  
  
fs = 500;  
tfestimate(x,y,1024,[],[],fs)
```

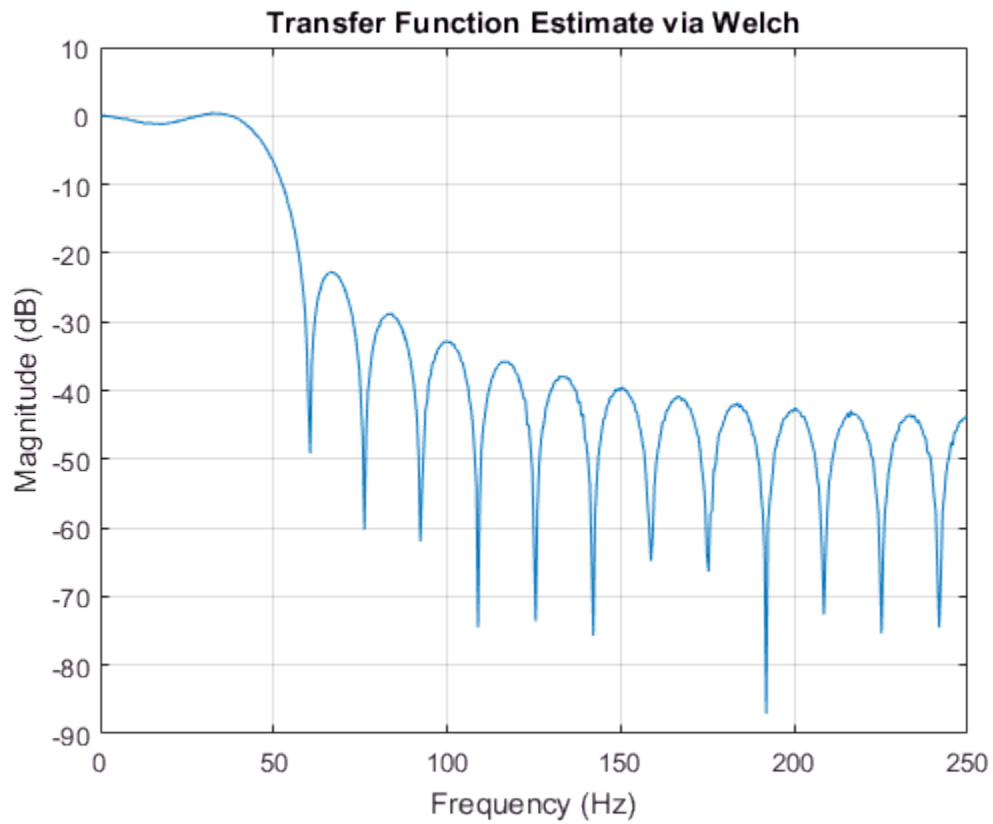
Use `fvtool` to verify that the transfer function approximates the frequency response of the filter.

```
fvtool(h,1,'Fs',fs)
```

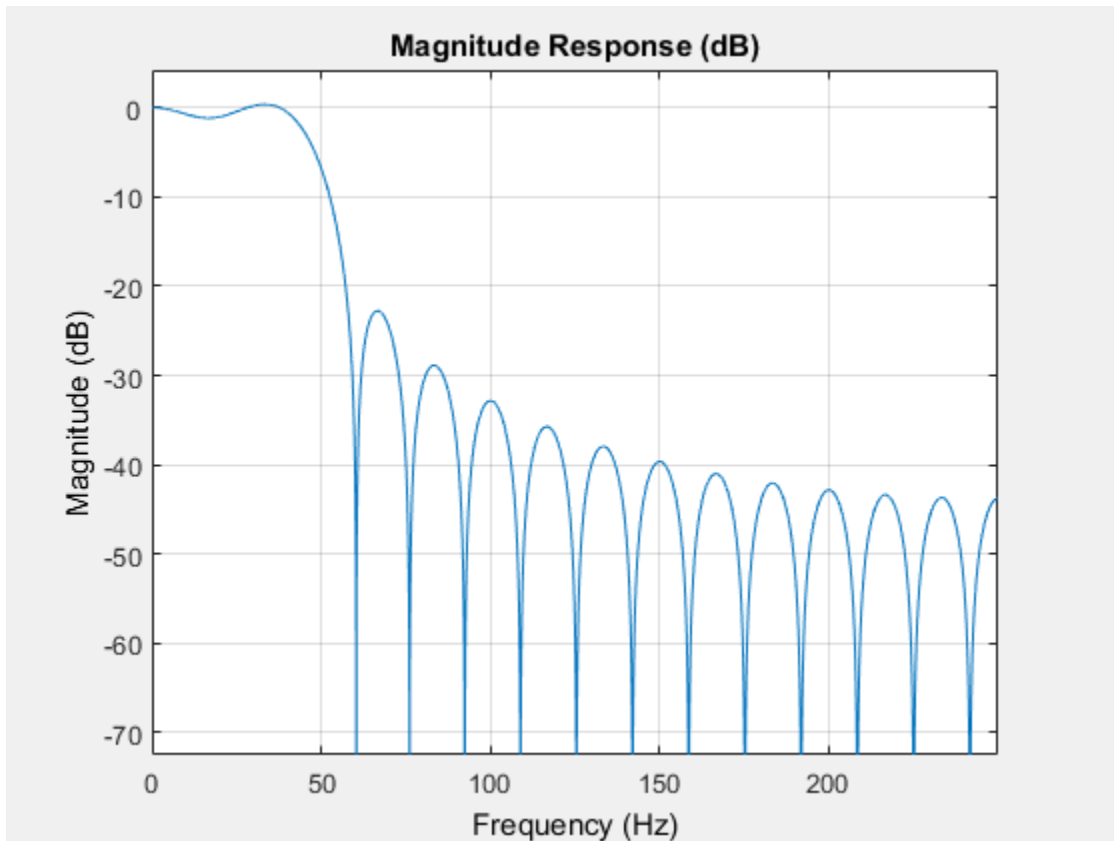

Obtain the same result by returning the transfer function estimate in a variable and plotting its absolute value in decibels.

```
[Txy,f] = tfestimate(x,y,1024,[],[],fs);
```

```
plot(f,mag2db(abs(Txy)))
```

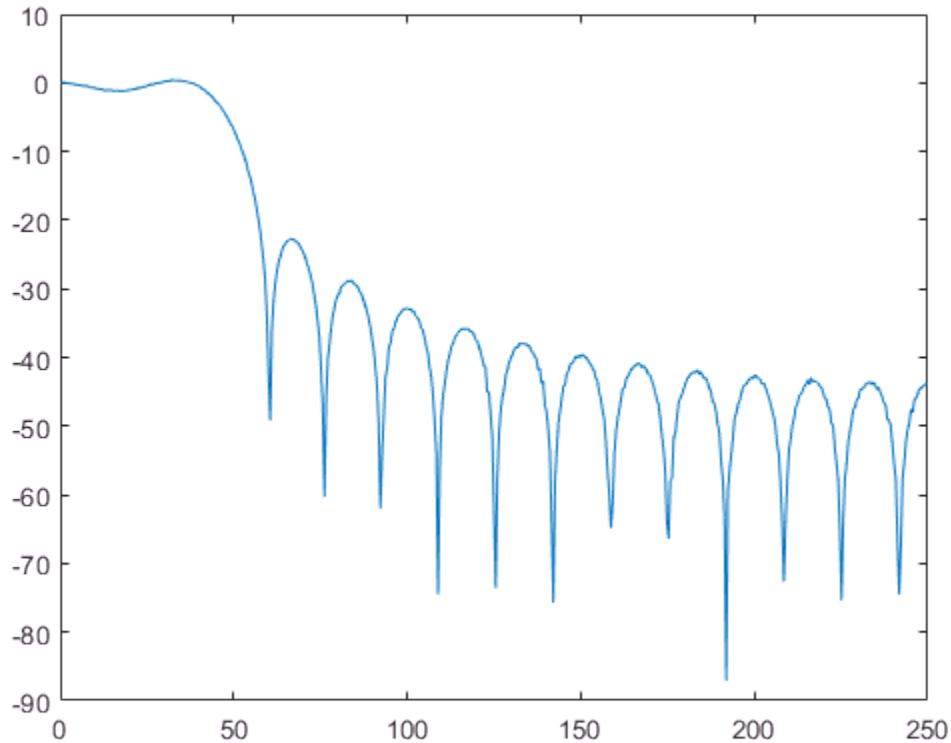

SISO Transfer Function

Estimate the transfer function for a simple single-input/single-output system and compare it to the definition.

A one-dimensional discrete-time oscillating system consists of a unit mass, m , attached to a wall by a spring of unit elastic constant. A sensor samples the acceleration, a , of the mass at $F_s = 1$ Hz. A damper impedes the motion of the mass by exerting on it a force proportional to speed, with damping constant $b = 0.01$.

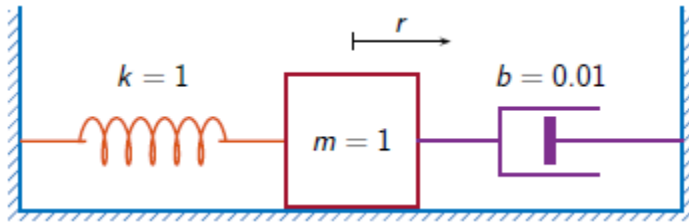

Generate 2000 time samples. Define the sampling interval $\Delta t = 1/F_s$.

```
Fs = 1;
dt = 1/Fs;
N = 2000;
t = dt*(0:N-1);
b = 0.01;
```

The system can be described by the state-space model

$$\begin{aligned}x(k+1) &= Ax(k) + Bu(k), \\y(k) &= Cx(k) + Du(k),\end{aligned}$$

where $x = [r \ v]^T$ is the state vector, r and v are respectively the position and velocity of the mass, u is the driving force, and $y = a$ is the measured output. The state-space matrices are

$$A = \exp(A_c \Delta t), \quad B = A_c^{-1}(A - I)B_c, \quad C = [-1 \ -b], \quad D = 1,$$

I is the 2×2 identity, and the continuous-time state-space matrices are

$$A_c = \begin{bmatrix} 0 & 1 \\ -1 & -b \end{bmatrix}, \quad B_c = \begin{bmatrix} 0 \\ 1 \end{bmatrix}.$$

```
Ac = [0 1; -1 -b];
A = expm(Ac*dt);
```

```
Bc = [0;1];  
B = Ac\((A-eye(size(A)))*Bc);
```

```
C = [-1 -b];  
D = 1;
```

The mass is driven by random input for half of the measurement interval. Use the state-space model to compute the time evolution of the system starting from an all-zero initial state. Plot the acceleration of the mass as a function of time.

```
rng default  
  
u = zeros(1,N);  
u(1:N/2) = randn(1,N/2);  
  
y = 0;  
x = [0;0];  
for k = 1:N  
    y(k) = C*x + D*u(k);  
    x = A*x + B*u(k);  
end  
  
plot(t,y)
```

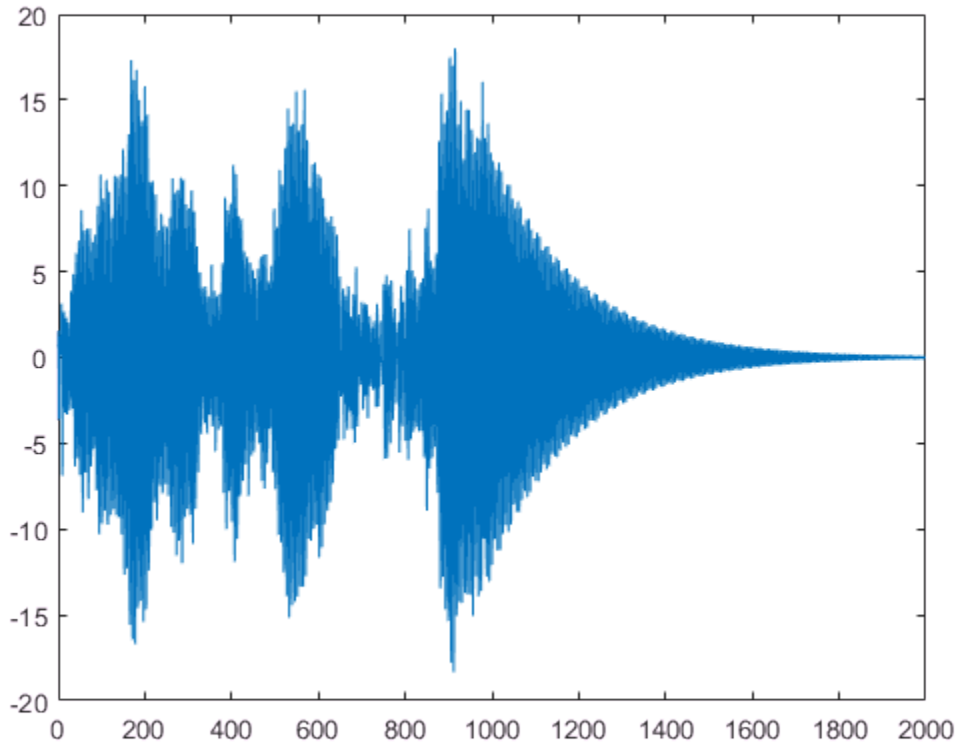

Estimate the transfer function of the system as a function of frequency. Use 2048 DFT points and specify a Kaiser window with a shape factor of 15. Use the default value of overlap between adjoining segments.

```
nfs = 2048;  
wind = kaiser(N,15);  
  
[txy,ft] = tfestimate(u,y,wind,[],nfs,Fs);
```

The frequency-response function of a discrete-time system can be expressed as the Z-transform of the time-domain transfer function of the system, evaluated at the unit circle. Verify that the estimate computed by `tfestimate` coincides with this definition.

```
[b,a] = ss2tf(A,B,C,D);
```

```
fz = 0:1/nfs:1/2-1/nfs;  
z = exp(2j*pi*fz);  
frf = polyval(b,z)./polyval(a,z);  
  
plot(ft,20*log10(abs(txy)))  
hold on  
plot(fz,20*log10(abs(frf)))  
hold off  
grid  
ylim([-60 40])
```

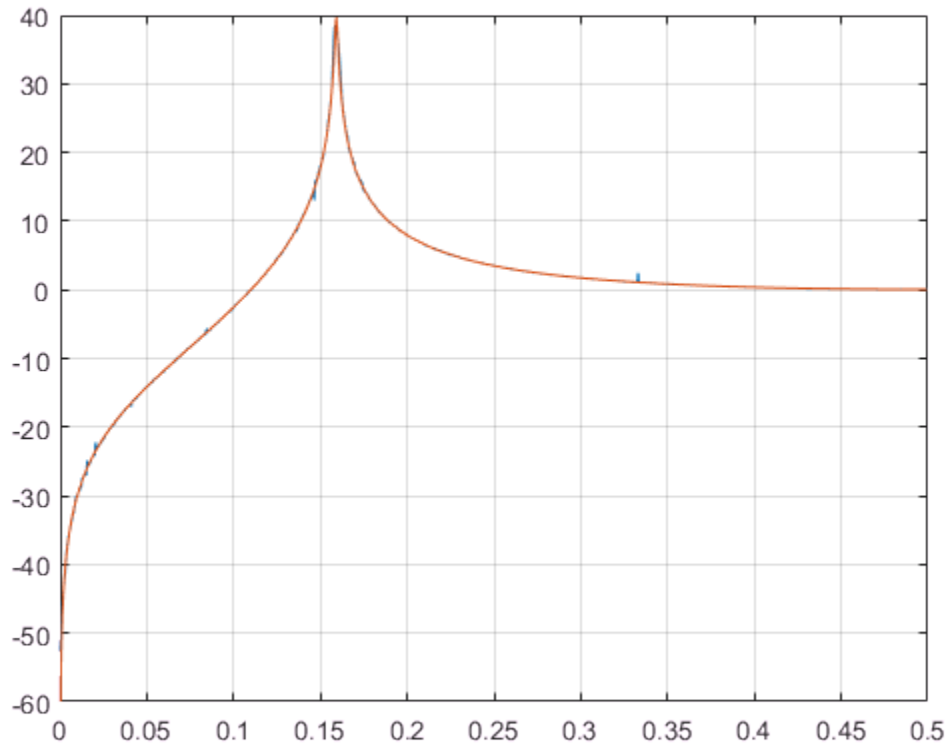

Plot the estimate using the built-in functionality of `tfestimate`.

```
tfestimate(u,y,wind,[],nfs,Fs)
```

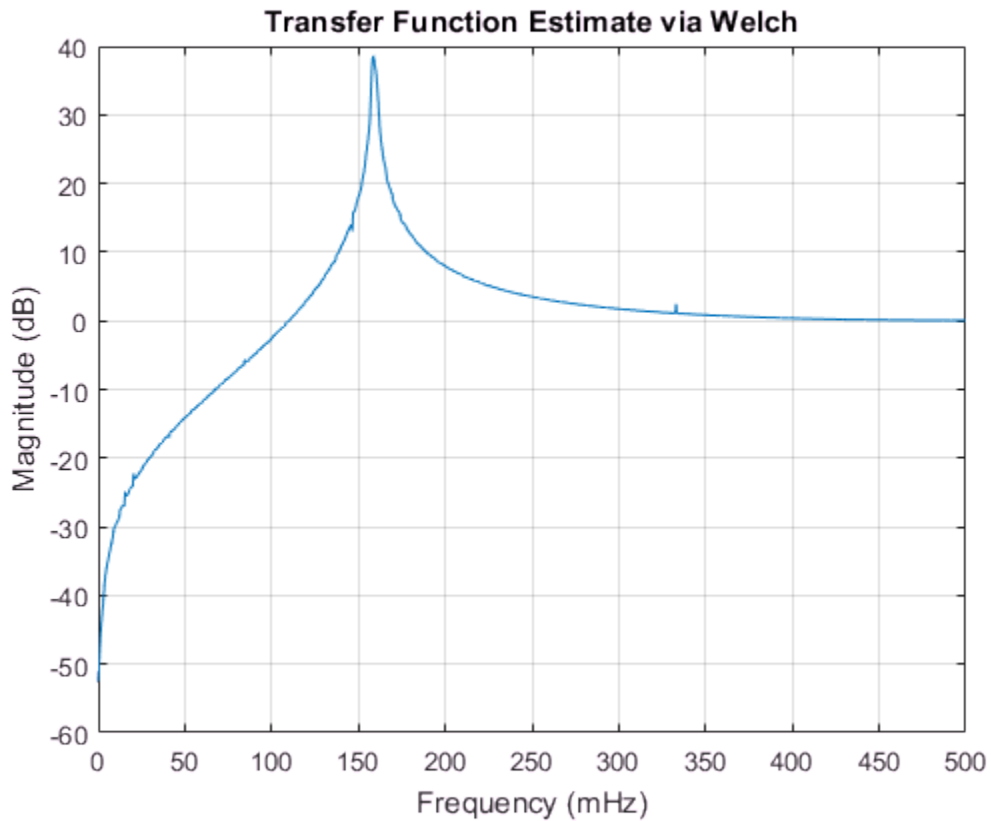

Transfer Function of MIMO System

Estimate the transfer function for a simple multi-input/multi-output system.

An ideal one-dimensional oscillating system consists of two masses, m_1 and m_2 , confined between two walls. The units are such that $m_1 = 1$ and $m_2 = \mu$. Each mass is attached to the nearest wall by a spring with an elastic constant k . An identical spring connects

the two masses. Three dampers impede the motion of the masses by exerting on them forces proportional to speed, with damping constant b . Sensors sample a_1 and a_2 , the accelerations of the masses, at $F_s = 50$ Hz.

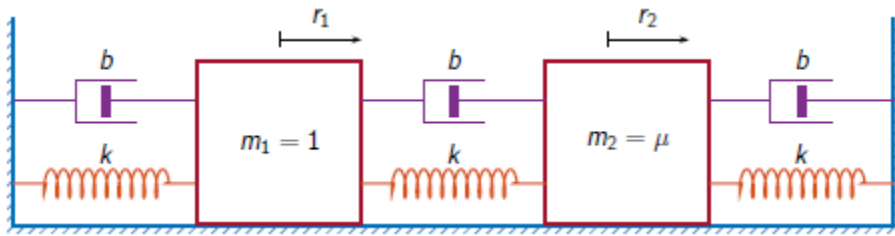

Generate 30000 time samples, equivalent to 600 seconds. Define the sampling interval $\Delta t = 1/F_s$.

```

Fs = 50;
dt = 1/Fs;
N = 30000;
t = dt*(0:N-1);

```

The system can be described by the state-space model

$$\begin{aligned} x(k+1) &= Ax(k) + Bu(k), \\ y(k) &= Cx(k) + Du(k), \end{aligned}$$

where $x = [r_1 \ v_1 \ r_2 \ v_2]^T$ is the state vector, r_i and v_i are respectively the location and the velocity of the i th mass, $u = [u_1 \ u_2]^T$ is the vector of input driving forces, and $y = [a_1 \ a_2]^T$ is the output vector. The state-space matrices are

$$A = \exp(A_c \Delta t), \quad B = A_c^{-1}(A - I)B_c, \quad C = \begin{bmatrix} -2k & -2b & k & b \\ k/\mu & b/\mu & -2k/\mu & -2b/\mu \end{bmatrix}, \quad D = \begin{bmatrix} 1 & 0 \\ 0 & 1/\mu \end{bmatrix},$$

I is the 4×4 identity, and the continuous-time state-space matrices are

$$A_c = \begin{bmatrix} 0 & 1 & 0 & 0 \\ -2k & -2b & k & b \\ 0 & 0 & 0 & 1 \\ k/\mu & b/\mu & -2k/\mu & -2b/\mu \end{bmatrix}, \quad B_c = \begin{bmatrix} 0 & 0 \\ 1 & 0 \\ 0 & 0 \\ 0 & 1/\mu \end{bmatrix}.$$

Set $k = 400$, $b = 0$, and $\mu = 1/10$.

```
k = 400;
b = 0;
m = 1/10;
```

```
Ac = [0 1 0 0; -2*k -2*b k b; 0 0 0 1; k/m b/m -2*k/m -2*b/m];
A = expm(Ac*dt);
Bc = [0 0; 1 0; 0 0; 0 1/m];
B = Ac \ (A-eye(4)) * Bc;
C = [-2*k -2*b k b; k/m b/m -2*k/m -2*b/m];
D = [1 0; 0 1/m];
```

The masses are driven by random input throughout the measurement. Use the state-space model to compute the time evolution of the system starting from an all-zero initial state.

```
rng default
u = randn(2,N);

x = [0;0;0;0];
for kk = 1:N
    y(:,kk) = C*x + D*u(:,kk);
    x = A*x + B*u(:,kk);
end
```

Use the input and output data to estimate the transfer function of the system as a function of frequency. Specify the 'mimo' option to produce all four transfer functions. Use a 5000-sample Hann window to divide the signals into segments. Specify 2500 samples of overlap between adjoining segments and 2^{14} . Plot the estimates.

```
wind = hann(5000);
nov = 2500;

[q,fq] = tfestimate(u',y',wind,nov,2^14,Fs,'mimo');
```

Compute the theoretical transfer function as the Z-transform of the time-domain transfer function, evaluated at the unit circle.

```
nfs = 2^14;

fz = 0:1/nfs:1/2-1/nfs;
z = exp(2j*pi*fz);

[b1,a1] = ss2tf(A,B,C,D,1);
[b2,a2] = ss2tf(A,B,C,D,2);

frf(1,:,1) = polyval(b1(1,:),z)./polyval(a1,z);
frf(1,:,2) = polyval(b1(2,:),z)./polyval(a1,z);

frf(2,:,1) = polyval(b2(1,:),z)./polyval(a2,z);
frf(2,:,2) = polyval(b2(2,:),z)./polyval(a2,z);
```

Plot the theoretical transfer functions and their corresponding estimates.

```
for jk = 1:2
    for kj = 1:2
        subplot(2,2,2*(jk-1)+kj)
        plot(fq,20*log10(abs(q(:,jk,kj))))
        hold on
        plot(fz*Fs,20*log10(abs(frf(jk,:,kj))))
        hold off
        grid
        title(['Input ' int2str(kj) ', Output ' int2str(jk)])
        axis([0 Fs/2 -50 100])
    end
end
```

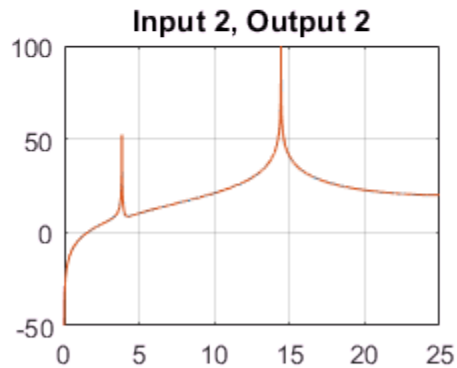
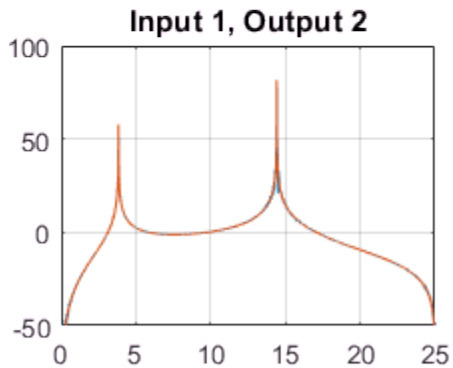
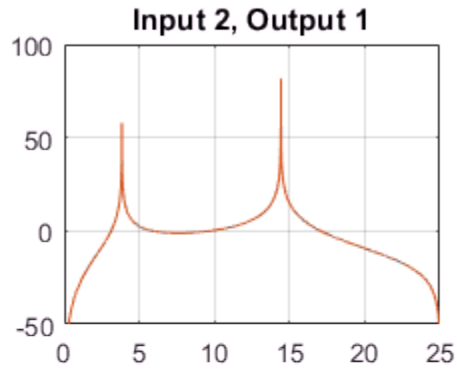
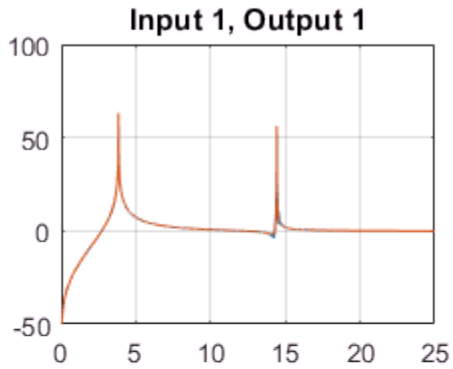

The transfer functions have maxima at the expected values, $\omega_{1,2}/2\pi$, where the ω are the eigenvalues of the modal matrix.

```
sqrt(eig(k*[2 -1;-1/m 2/m]))/(2*pi)
```

```
ans =
```

```
3.8470
14.4259
```

Add damping to the system by setting $b = 0.1$. Compute the time evolution of the damped system with the same driving forces. Compute the H_2 estimate of the MIMO transfer function using the same window and overlap. Plot the estimates using the `tfestimate` functionality.

```

b = 0.1;

Ac = [0 1 0 0; -2*k -2*b k b; 0 0 0 1; k/m b/m -2*k/m -2*b/m];
A = expm(Ac*dt);
B = Ac\ (A-eye(4))*Bc;
C = [-2*k -2*b k b; k/m b/m -2*k/m -2*b/m];

x = [0;0;0;0];
for kk = 1:N
    y(:,kk) = C*x + D*u(:,kk);
    x = A*x + B*u(:,kk);
end

clf
tfestimate(u',y',wind,nov,[],Fs,'mimo','Estimator','H2')
legend('I1, 01','I1, 02','I2, 01','I2, 02')

```

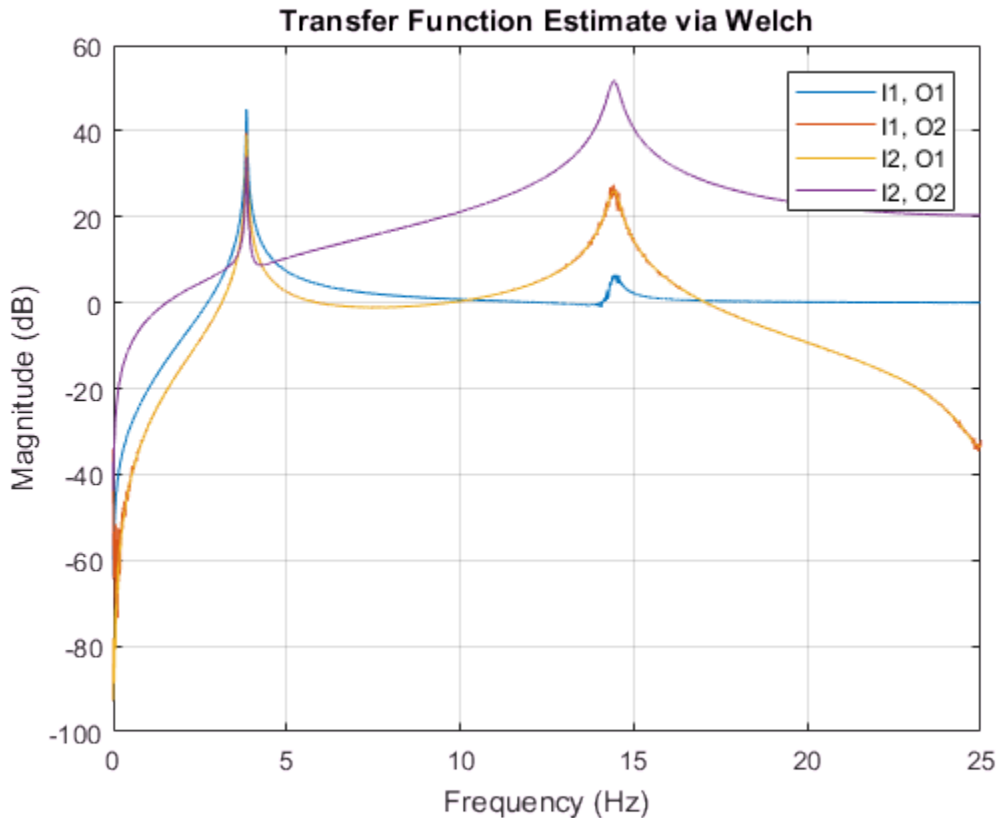

Compare the estimates to the theoretical predictions.

```
[b1,a1] = ss2tf(A,B,C,D,1);
[b2,a2] = ss2tf(A,B,C,D,2);

frf(1,:,1) = polyval(b1(1,:),z)./polyval(a1,z);
frf(1,:,2) = polyval(b1(2,:),z)./polyval(a1,z);

frf(2,:,1) = polyval(b2(1,:),z)./polyval(a2,z);
frf(2,:,2) = polyval(b2(2,:),z)./polyval(a2,z);

plot(fz*Fs,20*log10(abs(reshape(permute(frf,[2 1 3]),[nfs/2 4]))))
legend('I1, O1','I1, O2','I2, O1','I2, O2')
ylim([-60 60])
```

grid

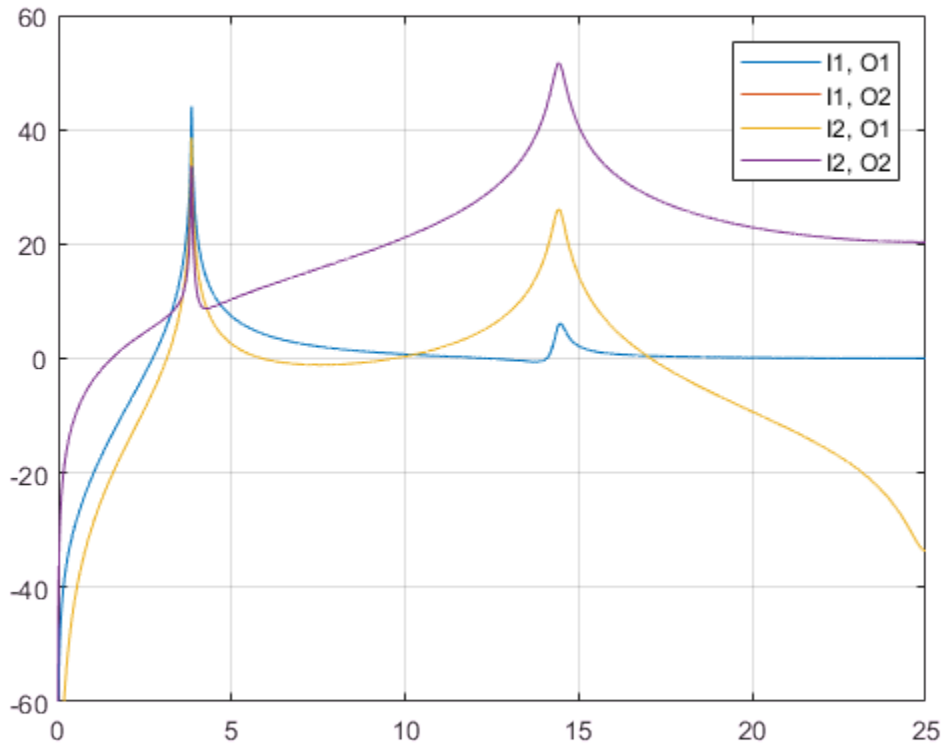

Input Arguments

x — Input signal

vector | matrix

Input signal, specified as a vector or matrix.

Example: `cos(pi/4*(0:159))+randn(1,160)` specifies a sinusoid embedded in white Gaussian noise.

Data Types: `single` | `double`
Complex Number Support: Yes

y — Output signal

vector | matrix

Output signal, specified as a vector or matrix.

Data Types: `single` | `double`
Complex Number Support: Yes

window — Window

integer | vector | []

Window, specified as an integer or as a row or column vector. Use `window` to divide the signal into segments.

- If `window` is an integer, then `tfestimate` divides `x` and `y` into segments of length `window` and windows each segment with a Hamming window of that length.
- If `window` is a vector, then `tfestimate` divides `x` and `y` into segments of the same length as the vector and windows each segment using `window`.

If the length of `x` and `y` cannot be divided exactly into an integer number of segments with `noverlap` overlapping samples, then the signals are truncated accordingly.

If you specify `window` as empty, then `tfestimate` uses a Hamming window such that `x` and `y` are divided into eight segments with `noverlap` overlapping samples.

For a list of available windows, see “Windows”.

Example: `hann(N+1)` and `(1 - cos(2*pi*(0:N)'/N))/2` both specify a Hann window of length `N + 1`.

Data Types: `single` | `double`

noverlap — Number of overlapped samples

positive integer | []

Number of overlapped samples, specified as a positive integer.

- If `window` is scalar, then `noverlap` must be smaller than `window`.
- If `window` is a vector, then `noverlap` must be smaller than the length of `window`.

If you specify `noverlap` as empty, then `tfestimate` uses a number that produces 50% overlap between segments. If the segment length is unspecified, the function sets `noverlap` to $\lfloor N/4.5 \rfloor$, where N is the length of the input and output signals.

Data Types: `double` | `single`

nfft — Number of DFT points

positive integer | []

Number of DFT points, specified as a positive integer. If you specify `nfft` as empty, then `tfestimate` sets this argument to $\max(256, 2^p)$, where $p = \lceil \log_2 N \rceil$ for input signals of length N .

Data Types: `single` | `double`

fs — Sample rate

positive scalar

Sample rate, specified as a positive scalar. The sample rate is the number of samples per unit time. If the unit of time is seconds, then the sample rate has units of Hz.

w — Normalized frequencies

vector

Normalized frequencies, specified as a row or column vector with at least two elements. Normalized frequencies are in rad/sample.

Example: `w = [pi/4 pi/2]`

Data Types: `double`

f — Frequencies

vector

Frequencies, specified as a row or column vector with at least two elements. The frequencies are in cycles per unit time. The unit time is specified by the sample rate, `fs`. If `fs` has units of samples/second, then `f` has units of Hz.

Example: `fs = 1000; f = [100 200]`

Data Types: `double`

freange — Frequency range for transfer function estimate

'onesided' | 'twosided' | 'centered'

Frequency range for the transfer function estimate, specified as a one of 'onesided', 'twosided', or 'centered'. The default is 'onesided' for real-valued signals and 'twosided' for complex-valued signals.

- 'onesided' — Returns the one-sided estimate of the transfer function between two real-valued input signals, x and y . If `nfft` is even, `txy` has $nfft/2 + 1$ rows and is computed over the interval $[0, \pi]$ rad/sample. If `nfft` is odd, `txy` has $(nfft + 1)/2$ rows and the interval is $[0, \pi]$ rad/sample. If you specify `fs`, the corresponding intervals are $[0, fs/2]$ cycles/unit time for even `nfft` and $[0, fs/2)$ cycles/unit time for odd `nfft`.
- 'twosided' — Returns the two-sided estimate of the transfer function between two real-valued or complex-valued input signals, x and y . In this case, `txy` has `nfft` rows and is computed over the interval $[0, 2\pi]$ rad/sample. If you specify `fs`, the interval is $[0, fs)$ cycles/unit time.
- 'centered' — Returns the centered two-sided estimate of the transfer function between two real-valued or complex-valued input signals, x and y . In this case, `txy` has `nfft` rows and is computed over the interval $(-\pi, \pi]$ rad/sample for even `nfft` and $(-\pi, \pi)$ rad/sample for odd `nfft`. If you specify `fs`, the corresponding intervals are $(-fs/2, fs/2]$ cycles/unit time for even `nfft` and $(-fs/2, fs/2)$ cycles/unit time for odd `nfft`.

Data Types: char

est — Transfer function estimator

'H1' (default) | 'H2'

Transfer function estimator, specified as 'H1' or 'H2'.

- Use 'H1' when the noise is uncorrelated with the input signals.
- Use 'H2' when the noise is uncorrelated with the output signals. In this case, the number of input signals must equal the number of output signals.

See “Transfer Function” on page 1-2389 for more information.

Output Arguments

txy — Transfer function estimate

vector | matrix | three-dimensional array

Transfer function estimate, returned as a vector, matrix, or three-dimensional array.

w — Normalized frequencies

vector

Normalized frequencies, returned as a real-valued column vector.

f — Cyclical frequencies

vector

Cyclical frequencies, returned as a real-valued column vector.

Definitions

Transfer Function

The relationship between the input x and output y is modeled by the linear, time-invariant *transfer function* τ_{xy} . In the frequency domain, $Y(f) = H(f)X(f)$.

- For a single-input/single-output system, the H_1 estimate of the transfer function is given by

$$H_1(f) = \frac{P_{yx}(f)}{P_{xx}(f)},$$

where P_{yx} is the cross power spectral density of x and y , and P_{xx} is the power spectral density of x . This estimate assumes that the noise is not correlated with the system input.

For multi-input/multi-output (MIMO) systems, the H_1 estimator becomes

$$H_1(f) = P_{YX}(f)P_{XX}^{-1}(f) = \begin{bmatrix} P_{y_1x_1}(f) & P_{y_1x_2}(f) & \cdots & P_{y_1x_m}(f) \\ P_{y_2x_1}(f) & P_{y_2x_2}(f) & \cdots & P_{y_2x_m}(f) \\ \vdots & \vdots & \ddots & \vdots \\ P_{y_nx_1}(f) & P_{y_nx_2}(f) & \cdots & P_{y_nx_m}(f) \end{bmatrix} \begin{bmatrix} P_{x_1x_1}(f) & P_{x_1x_2}(f) & \cdots & P_{x_1x_m}(f) \\ P_{x_2x_1}(f) & P_{x_2x_2}(f) & \cdots & P_{x_2x_m}(f) \\ \vdots & \vdots & \ddots & \vdots \\ P_{x_mx_1}(f) & P_{x_mx_2}(f) & \cdots & P_{x_mx_m}(f) \end{bmatrix}^{-1}$$

for m inputs and n outputs, where:

- P_{y,x_k} is the cross power spectral density of the k th input and the i th output.

- $P_{x_i x_k}$ is the cross power spectral density of the k th and i th inputs.

For two inputs and two outputs, the estimator is the matrix

$$H_1(f) = \frac{\begin{bmatrix} P_{y_1 x_1}(f)P_{x_2 x_2}(f) - P_{y_1 x_2}(f)P_{x_2 x_1}(f) & P_{y_1 x_2}(f)P_{x_1 x_1}(f) - P_{y_1 x_1}(f)P_{x_1 x_2}(f) \\ P_{y_2 x_1}(f)P_{x_2 x_2}(f) - P_{y_2 x_2}(f)P_{x_2 x_1}(f) & P_{y_2 x_2}(f)P_{x_1 x_1}(f) - P_{y_2 x_1}(f)P_{x_1 x_2}(f) \end{bmatrix}}{P_{x_1 x_1}(f)P_{x_2 x_2}(f) - P_{x_1 x_2}(f)P_{x_2 x_1}(f)}$$

- For a single-input/single-output system, the H_2 estimate of the transfer function is given by

$$H_2(f) = \frac{P_{yy}(f)}{P_{xy}(f)},$$

where P_{yy} is the power spectral density of \mathbf{y} and $P_{xy} = P_{yx}^*$ is the complex conjugate of the cross power spectral density of \mathbf{x} and \mathbf{y} . This estimate assumes that the noise is not correlated with the system output.

For MIMO systems, the H_2 estimator is well-defined only for equal numbers of inputs and outputs: $n = m$. The estimator becomes

$$H_1(f) = P_{YY}(f)P_{XY}^{-1}(f) = \begin{bmatrix} P_{y_1 y_1}(f) & P_{y_1 y_2}(f) & \cdots & P_{y_1 y_n}(f) \\ P_{y_2 y_1}(f) & P_{y_2 y_2}(f) & \cdots & P_{y_2 y_n}(f) \\ \vdots & \vdots & \ddots & \vdots \\ P_{y_n y_1}(f) & P_{y_n y_2}(f) & \cdots & P_{y_n y_n}(f) \end{bmatrix} \begin{bmatrix} P_{x_1 y_1}(f) & P_{x_1 y_2}(f) & \cdots & P_{x_1 y_n}(f) \\ P_{x_2 y_1}(f) & P_{x_2 y_2}(f) & \cdots & P_{x_2 y_n}(f) \\ \vdots & \vdots & \ddots & \vdots \\ P_{x_n y_1}(f) & P_{x_n y_2}(f) & \cdots & P_{x_n y_n}(f) \end{bmatrix}^{-1},$$

where:

- $P_{y_i y_k}$ is the cross power spectral density of the k th and i th outputs.
- $P_{x_i y_k}$ is the complex conjugate of the cross power spectral density of the i th input and the k th output.

Algorithms

`tfestimate` uses Welch's averaged periodogram method. See `pwelch` for details.

References

- [1] Vold, Håvard, John Crowley, and G. Thomas Rocklin. “New Ways of Estimating Frequency Response Functions.” *Sound and Vibration*. Vol. 18, November 1984, pp. 34–38.

See Also

See Also

`cpsd` | `mscohere` | `periodogram` | `pwelch`

Introduced before R2006a

tfridge

Time-frequency ridges

Syntax

```
fridge = tfridge(tfm,f)
[fridge,iridge] = tfridge(tfm,f)
[fridge,iridge,lridge] = tfridge(tfm,f)

[ ___ ] = tfridge(tfm,f,penalty)

[ ___ ] = tfridge( ___, 'NumRidges', nr)
[ ___ ] = tfridge( ___, 'NumRidges', nr, 'NumFrequencyBins', nbins)
```

Description

`fridge = tfridge(tfm,f)` extracts the maximum-energy time-frequency ridge from the time-frequency matrix, `tfm`, and the frequency vector, `f`, and outputs the time-dependent frequency, `fridge`.

`[fridge,iridge] = tfridge(tfm,f)` also returns the row-index vector corresponding to the maximum-energy ridge.

`[fridge,iridge,lridge] = tfridge(tfm,f)` also returns the linear indices, `lridge`, such that `tfm(lridge)` are the values of `tfm` along the maximum-energy ridge.

`[___] = tfridge(tfm,f,penalty)` penalizes changes in frequency by scaling the squared distance between frequency bins by `penalty`.

`[___] = tfridge(___, 'NumRidges', nr)` extracts the `nr` time-frequency ridges with the highest energy. This syntax accepts any combination of input arguments from previous syntaxes.

`[___] = tfridge(___, 'NumRidges', nr, 'NumFrequencyBins', nbins)` specifies the number of frequency bins around a ridge that are removed from `tfm` when extracting multiple ridges.

Examples

Find Ridge of Noisy Signal

Create a matrix that resembles a time-frequency matrix with a sharp ridge. Visualize the matrix in three dimensions.

```
t = 0:0.05:10;
f = 0:0.2:8;
rv = 1;

[F,T] = ndgrid(f,t);

S = zeros(size(T));
S(abs((F-4)-cos((T-6).^2))<0.1) = rv;

mesh(T,F,S)
view(-30,60)
```

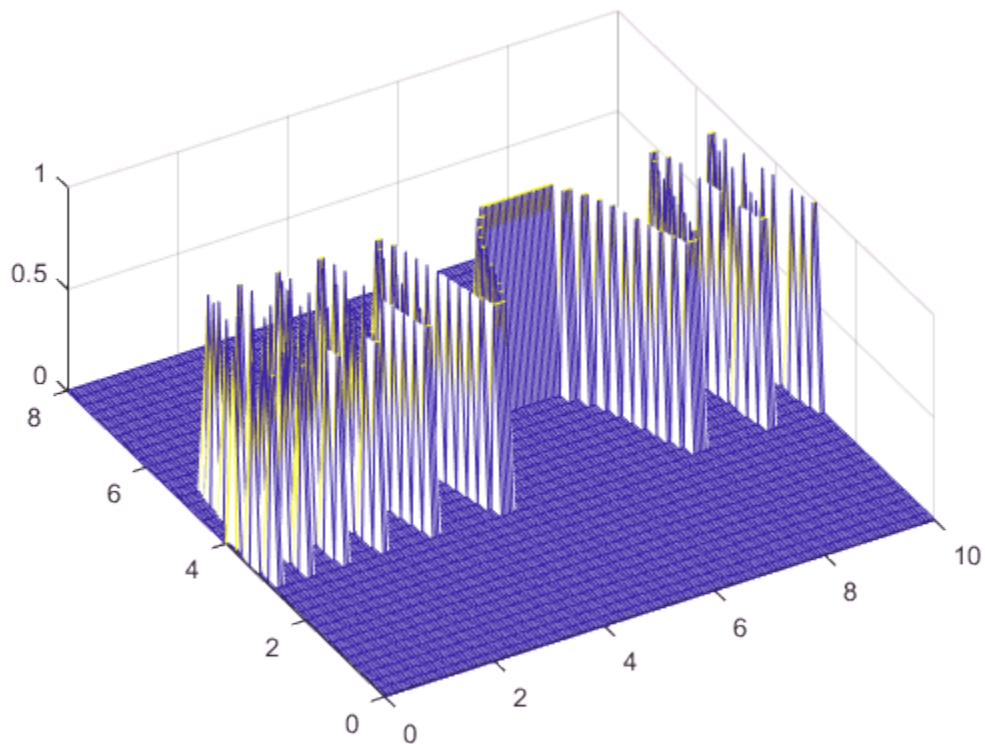

Add noise to the matrix and redisplay the plot.

```
S = S+rand(size(S))/10;
```

```
mesh(T,F,S)  
view(-30,60)  
xlabel('Time')  
ylabel('Frequency')
```

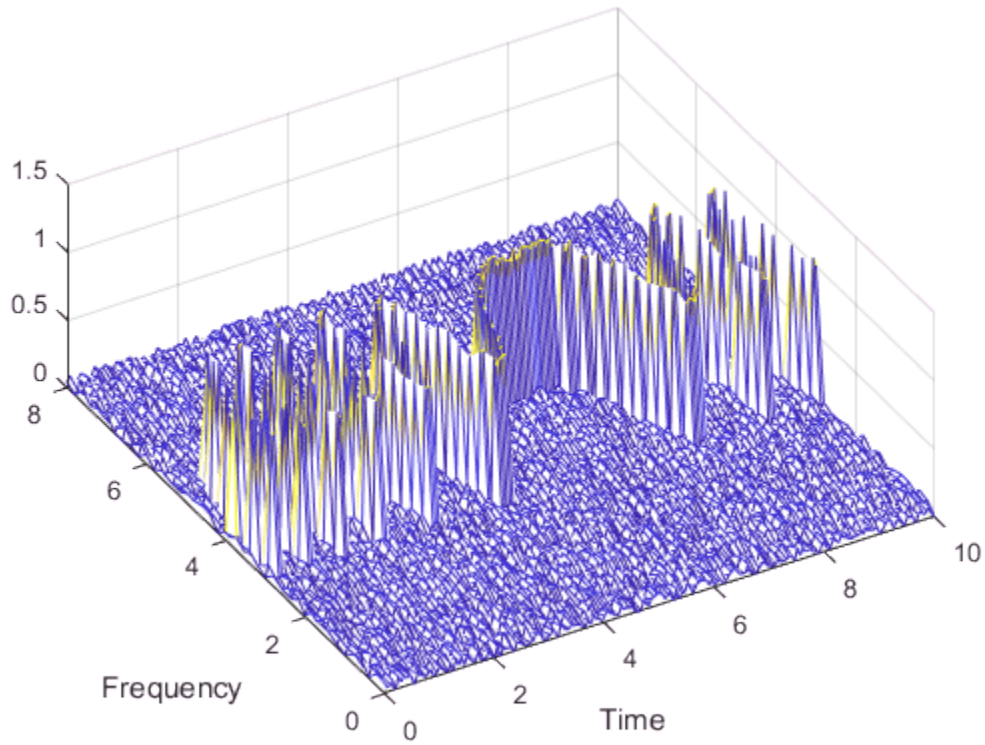
Extract the ridge and plot the result.

```
[fridge,~,lridge] = tfridge(S,f);  
rvals = S(lridge);  
  
hold on  
plot3(t,fridge,rvals,'k','linewidth',4)  
hold off
```

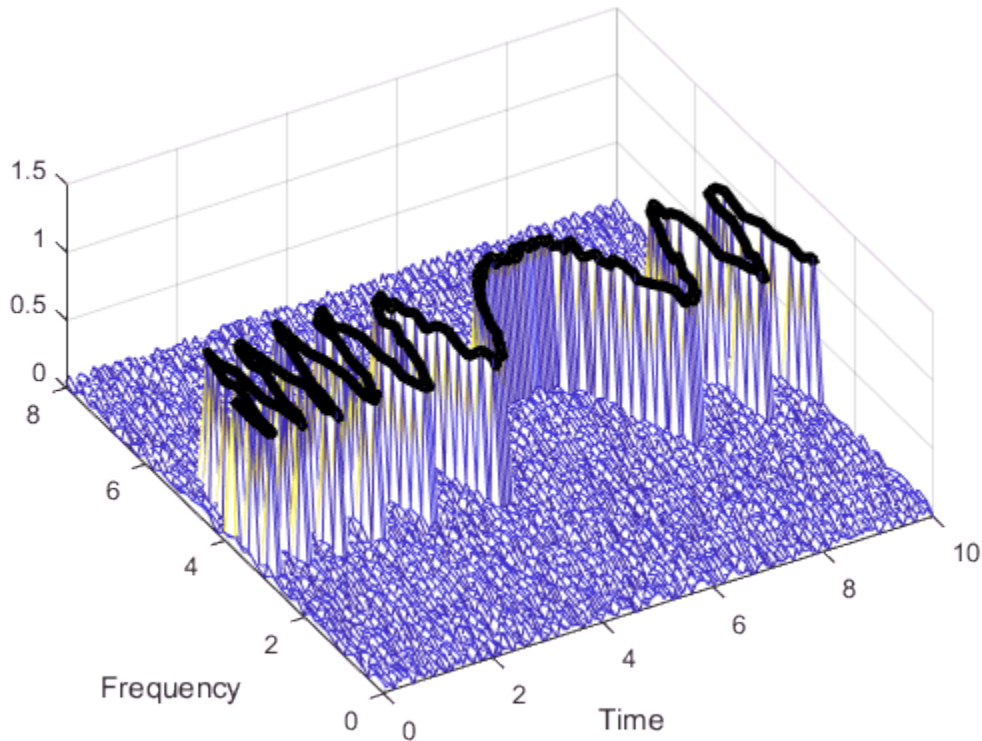

Extract High-Energy Ridges from Multicomponent Signal

Generate a signal that is sampled at 3 kHz for one second. The signal consists of two tones and a quadratic chirp.

- The first tone has a frequency of 1000 Hz and unit amplitude.
- The second tone has a frequency of 1200 Hz and unit amplitude.
- The chirp has an initial frequency of 500 Hz and reaches 750 Hz at the end of the sampling. It has an amplitude of six.

```
fs = 3000;
t = 0:1/fs:1-1/fs;
```

```
x1 = 6*chirp(t,fs/6,t(end),fs/4,'quadratic');  
x2 = sin(2*pi*fs/3*t);  
x3 = sin(2*pi*fs/2.5*t);  
  
x = x1+x2+x3;
```

Compute and display the Fourier synchrosqueezed transform of the signal.

```
[sst,f] = fsst(x,fs);  
mx = max(abs(sst(:)))*ones(size(t));  
  
mesh(t,f,abs(sst))  
view(2)
```

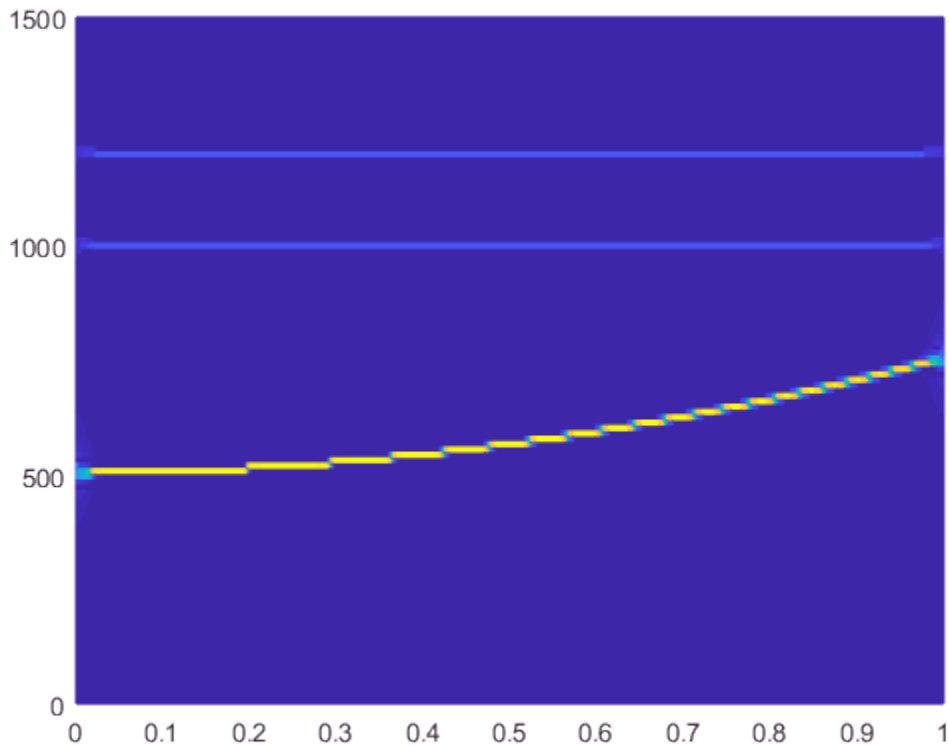

Extract and plot the two highest-energy signal components. Set no penalty for changing frequency.

```
penval = 0;
fridge = tfridge(sst,f,penval,'NumRidges',2);
hold on
plot3(t,fridge,mx,'w','linewidth',5)
hold off
```

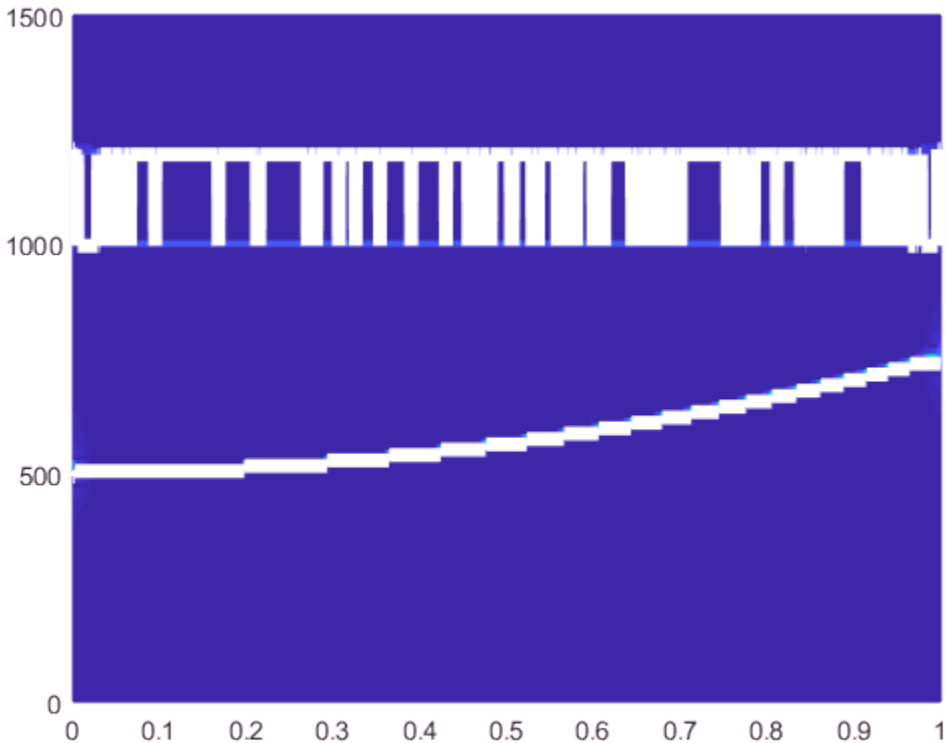

The two tones have the same amplitude, and the algorithm jumps between them. Set the penalty for changing frequency to 1.

```
penval = 1;
```

```
fridge = tfridge(sst,f,penal,'NumRidges',2);  
  
mesh(t,f,abs(sst))  
view(2)  
xlabel('Time (s)')  
ylabel('Frequency (Hz)')  
  
hold on  
plot3(t,fridge,mx,'w','linewidth',5)  
hold off
```

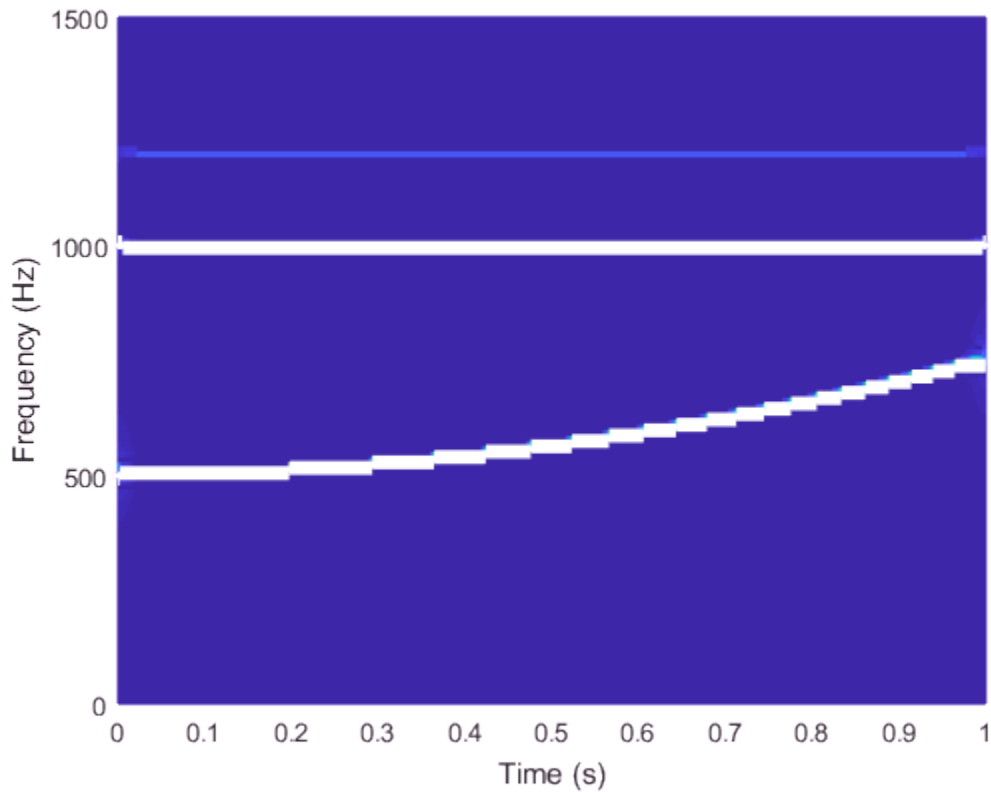

Set the penalty to a high value for comparison. The chirp is penalized because its frequency is not constant.

```
penval = 1000;  
fridge = tfridge(sst,f,penval,'NumRidges',2);  
  
mesh(t,f,abs(sst))  
view(2)  
xlabel('Time (s)')  
ylabel('Frequency (Hz)')  
  
hold on  
plot3(t,fridge,mx,'w','linewidth',5)  
hold off
```

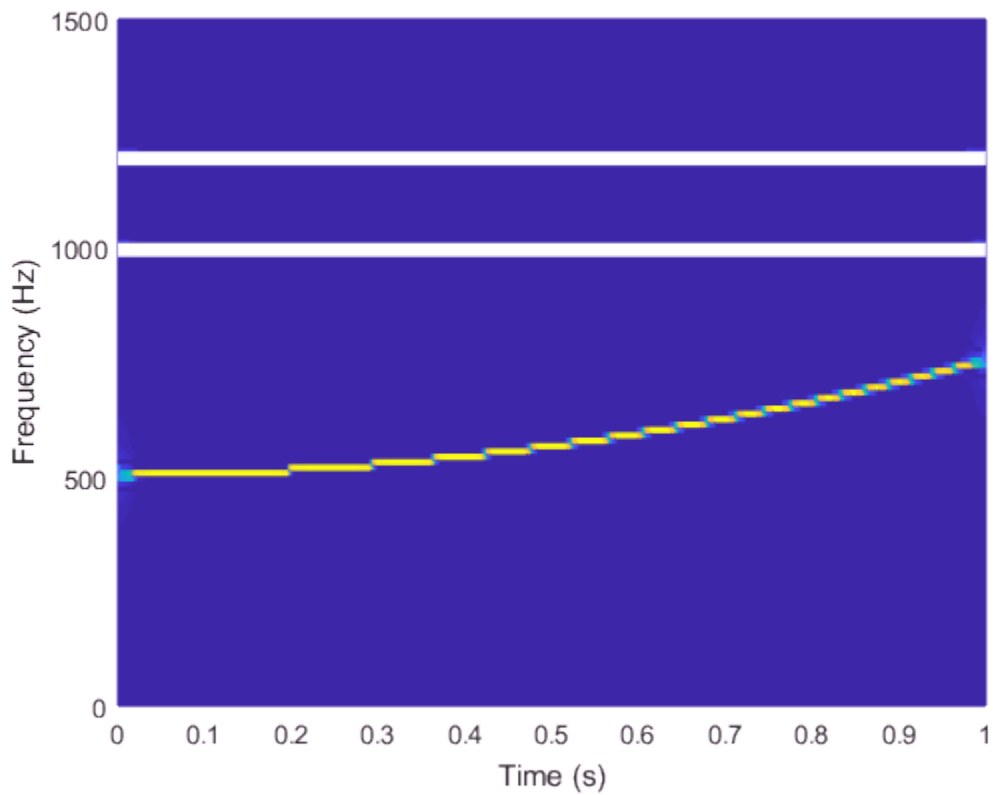

Effect of Neighbor Bin Removal

Generate a signal composed of two quadratic chirps. The signal is sampled at 1 kHz for 3 seconds. The chirps are such that the instantaneous frequency is symmetric about the halfway point of the sampling interval. One chirp is concave and the other chirp is convex. The concave chirp has twice the amplitude of the convex chirp.

```
fs = 1e3;  
t = 0:1/fs:3;  
  
x = chirp(t-1.5,100,1.1,200,'quadratic',[],'convex');  
y = 2*chirp(t-1.5,300,1.1,400,'quadratic',[],'concave');
```

```
% To hear, type soundsc(x+y,fs)
```

Compute and display the Fourier synchrosqueezed transform of the signal.

```
sig = x+y;  
  
[sst,f,t] = fsst(sig,fs);  
  
fsst(sig,fs,'yaxis')
```

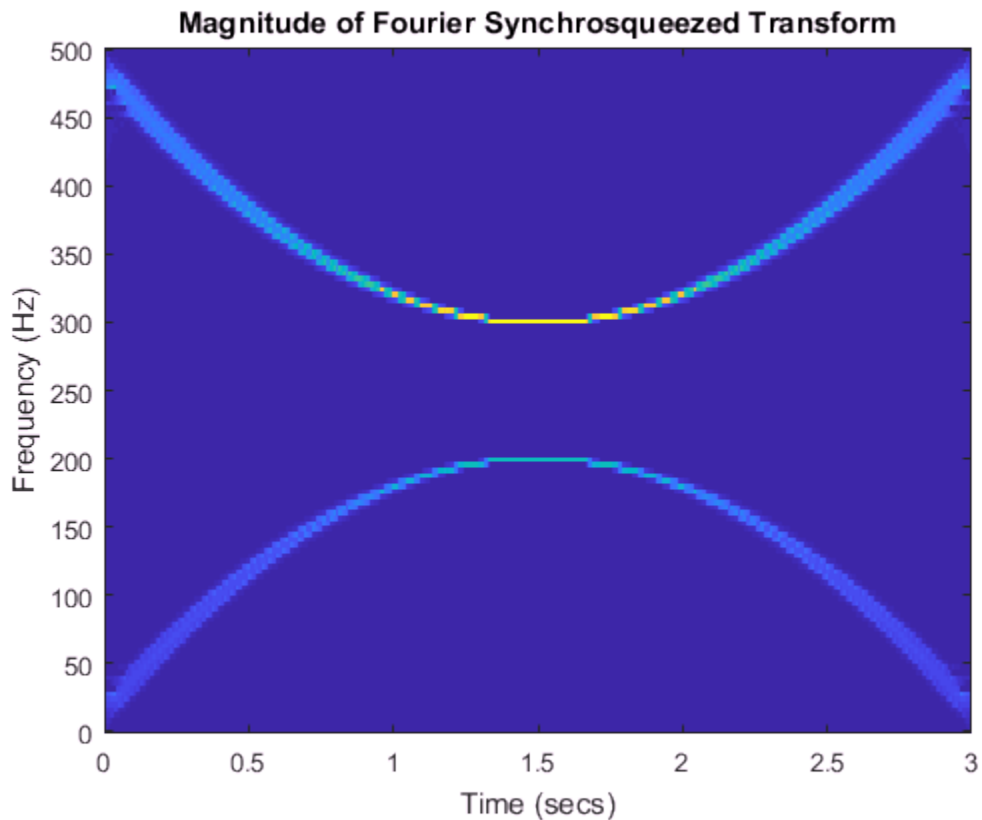

Extract the two time-frequency ridges that have the highest energy. Specify a penalty of 1 for changes in frequency. Remove 1 frequency bin around the ridge with the highest energy before extracting the second ridge. Plot the ridges.

```
nfb = 1;  
[fr,ir] = tfridge(sst,f,1,'NumRidges',2,'NumFrequencyBins',nfb);  
  
plot(t,fr)
```

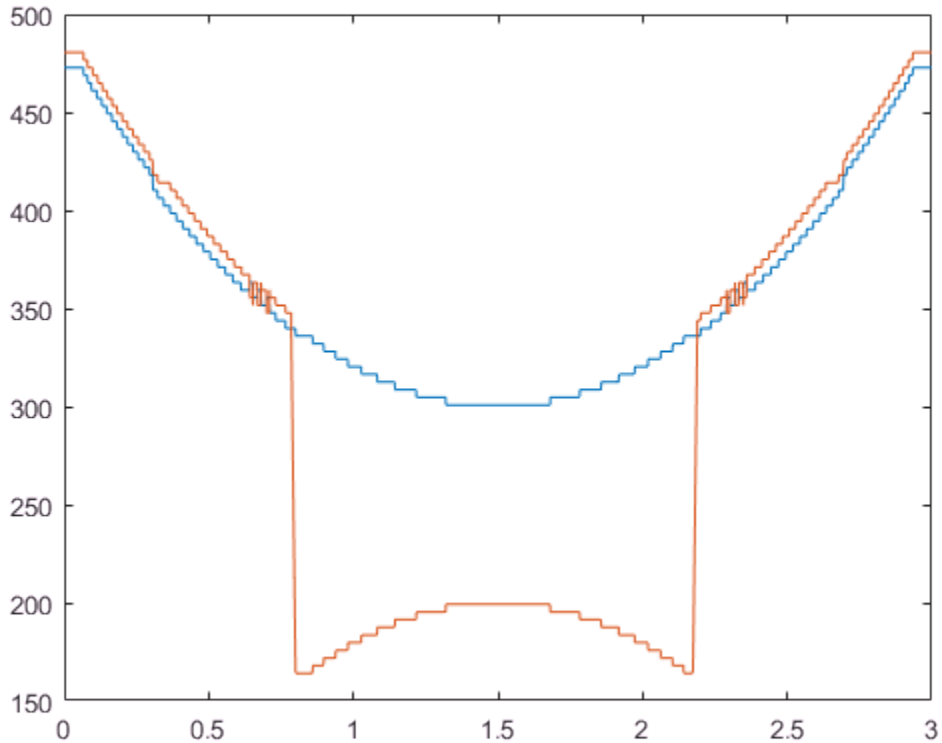
One bin is insufficient: The function finds a second ridge that is partly on the slope of the first. Increase to 50 the number of bins to remove and repeat the calculation.

```
nfb = 50;  
[fr,ir] = tfridge(sst,f,1,'NumRidges',2,'NumFrequencyBins',nfb);  
plot(t,fr)
```

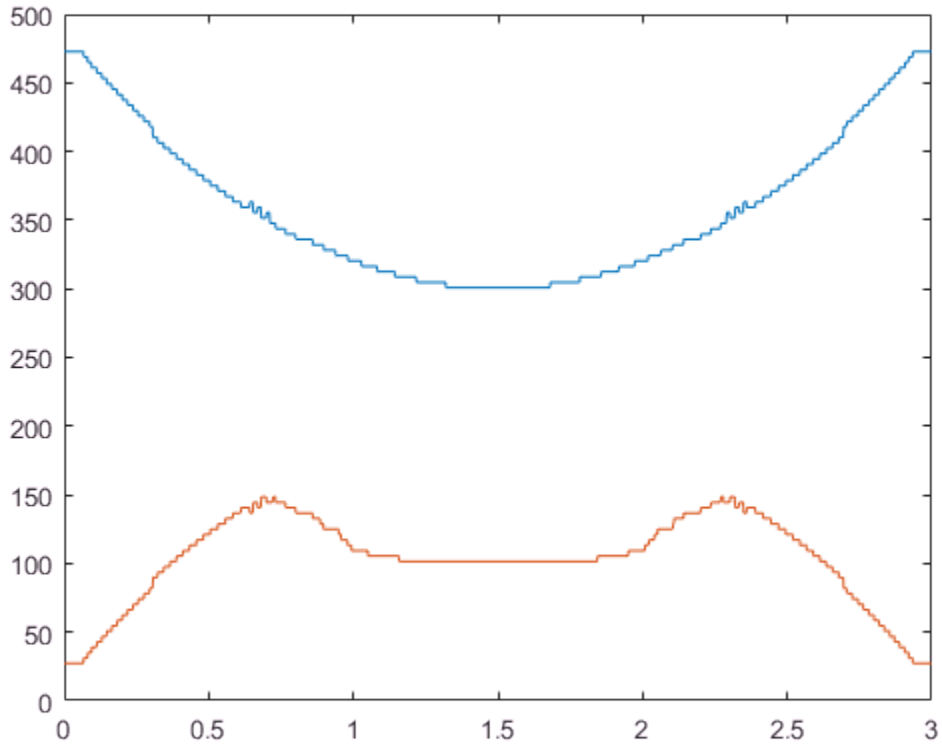

Removing too many bins distorts lower-energy ridges. Decrease the number to 15 and repeat the calculation.

```
nfb = 15;  
[fr,ir] = tfridge(sst,f,1,'NumRidges',2,'NumFrequencyBins',nfb);  
plot(t,fr)
```

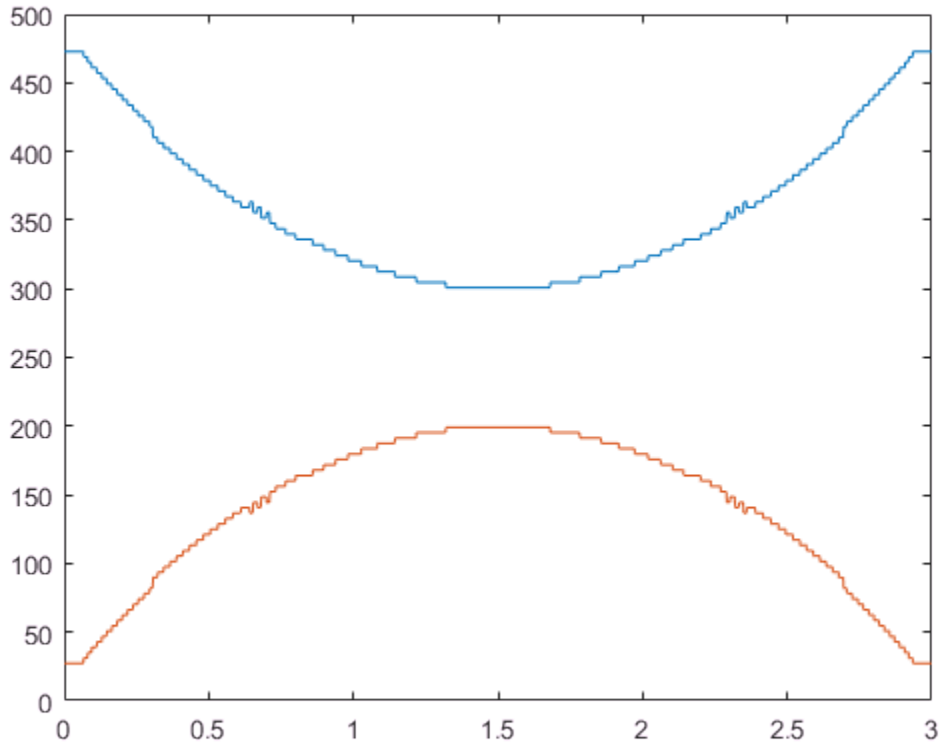

Invert the transform corresponding to the two ridges. Add the ridges to reconstruct the signal. Plot the difference between the reconstructed signal and the chirps.

```
itr = ifsst(sst,[],ir,'NumFrequencyBins',nfb);  
xrec = sum(itr');  
  
plot(t,xrec-(x+y))  
ylim([-0.1 0.1])
```

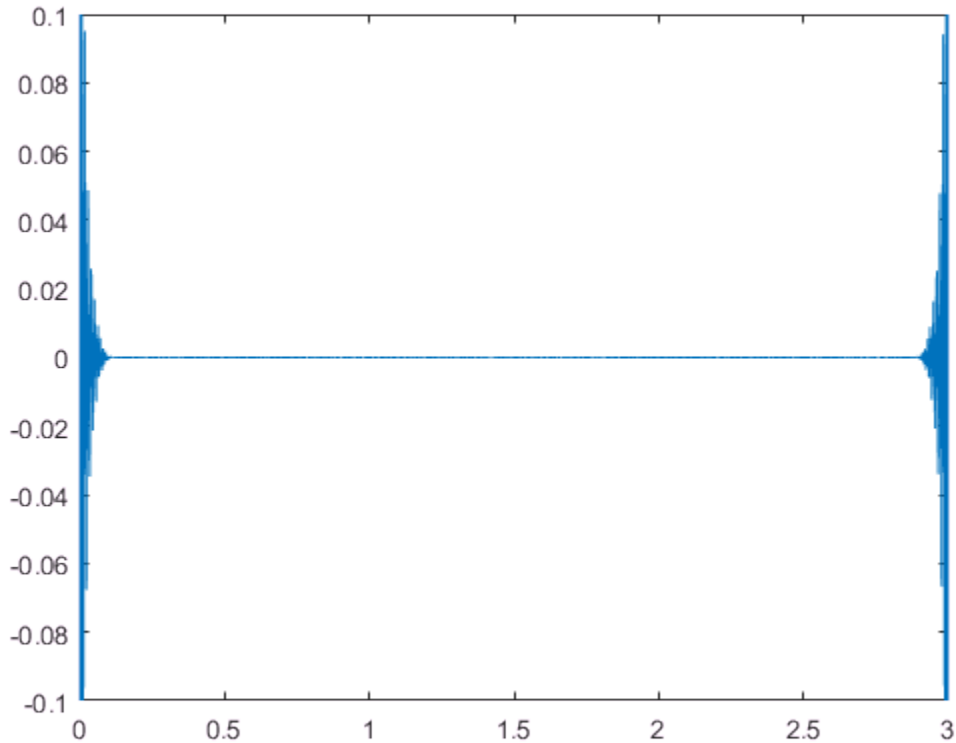

`% To hear, type soundsc(xrec,fs)`

The agreement is good most of the time but deteriorates at the ends, where frequencies change most rapidly.

- “Practical Introduction to Time-Frequency Analysis”

Input Arguments

tfm — Time-frequency matrix
matrix

Time-frequency matrix, specified as a matrix.

Example: `fsst(cos(pi/4*(0:159)))` specifies the synchrosqueezed transform of a sinusoid.

Data Types: `single` | `double`

Complex Number Support: Yes

f — Sampling frequencies

vector

Sampling frequencies, specified as a vector. The length of `f` must equal the number of rows in `tfm`.

Data Types: `single` | `double`

penalty — Penalty for changing frequency

0 (default) | nonnegative real scalar

Penalty for changing frequency, specified as a nonnegative real scalar.

Data Types: `single` | `double`

nr — Number of time-frequency ridges to extract

1 (default) | positive integer scalar

Number of time-frequency ridges to extract, specified as the comma-separated pair consisting of 'NumRidges' and a positive integer scalar. You can specify this name-value pair anywhere after `tfm` in the input argument list.

When `nr` is greater than 1, `tfridge`:

- 1 Extracts the time-frequency ridge with the highest energy
- 2 Removes from `tfm` the energy contained in the ridge it extracted and in the `nbins` adjacent frequency bins on either side of the ridge
- 3 Extracts the highest-energy ridge in the modified `tfm`
- 4 Iterates until it has extracted `nr` ridges

Data Types: `single` | `double`

nbins — Number of bins to remove

4 (default) | positive integer scalar

Number of bins to remove when extracting multiple ridges, specified as the comma-separated pair consisting of 'NumFrequencyBins' and a positive integer scalar. `nbins` must be smaller than 1/4 of the sampling frequencies. Indices close to the frequency edges that have fewer than `nbins` bins on one side are reconstructed using a smaller number of bins.

Data Types: `single` | `double`

Output Arguments

`fridge` — Time-frequency ridges

matrix

Time-frequency ridges, returned as a matrix with `nr` columns. The number of rows in `fridge` equals the number of columns in `tfm`. The first column contains the frequencies that correspond to the highest-energy ridge. Subsequent columns contain the frequencies of the other ridges in decreasing order of energy.

`iridge` — Ridge row indices

matrix

Ridge row indices, returned as a matrix with `nr` columns. The number of rows in `iridge` equals the number of columns in `tfm`. The first column contains the indices that correspond to the highest-energy ridge. Subsequent columns contain the indices of the other ridges in decreasing order of energy.

`lridge` — Ridge linear indices

matrix

Ridge linear indices, returned as a matrix with `nr` columns. `lridge` is defined so that `tfm(lridge)` is the amplitude of `tfm` along the ridges. The number of rows in `lridge` equals the number of columns in `tfm`. The first column contains the indices that correspond to the highest-energy ridge. Subsequent columns contain the indices of the other ridges in decreasing order of energy.

Example: `lridge` is equivalent to `sub2ind(size(tfm),iridge, repmat((1:size(tfm,2))',1,nr))`.

See Also

See Also

[fsst](#) | [ifsst](#) | [spectrogram](#) | [sub2ind](#)

Topics

“Practical Introduction to Time-Frequency Analysis”

Introduced in R2016b

thd

Total harmonic distortion

Syntax

```
r = thd(x)
```

```
r = thd(x,fs,n)
```

```
r = thd(pxx,f,'psd')
```

```
r = thd(pxx,f,n,'psd')
```

```
r = thd(sxx,f,rbw,'power')
```

```
r = thd(sxx,f,rbw,n,'power')
```

```
r = thd( ____, 'aliased')
```

```
[r,harpow,harmfreq] = thd( ____)
```

```
thd( ____)
```

Description

`r = thd(x)` returns the total harmonic distortion (THD) in dBc of the real-valued sinusoidal signal `x`. The total harmonic distortion is determined from the fundamental frequency and the first five harmonics using a modified periodogram of the same length as the input signal. The modified periodogram uses a Kaiser window with $\beta = 38$.

`r = thd(x,fs,n)` specifies the sample rate, `fs`, and the number of harmonics (including the fundamental) to use in the THD calculation.

`r = thd(pxx,f,'psd')` specifies the input `pxx` as a one-sided power spectral density (PSD) estimate. `f` is a vector of frequencies corresponding to the PSD estimates in `pxx`.

`r = thd(pxx,f,n,'psd')` specifies the number of harmonics (including the fundamental) to use in the THD calculation.

`r = thd(sxx,f,rbw,'power')` specifies the input as a one-sided power spectrum. `rbw` is the resolution bandwidth over which each power estimate is integrated.

`r = thd(sxx,f,rbw,n,'power')` specifies the number of harmonics (including the fundamental) to use in the THD calculation.

`r = thd(____, 'aliased')` reports harmonics of the fundamental that are aliased into the Nyquist range. Use this option when the input signal is undersampled. If you do not specify this option, or if you set it to `'omitaliases'`, then the function ignores any harmonics of the fundamental frequency that lie beyond the Nyquist range.

`[r,harmpow,harmfreq] = thd(____)` returns the powers (in dB) and frequencies of the harmonics, including the fundamental.

`thd(____)` with no output arguments plots the spectrum of the signal and annotates the harmonics in the current figure window. It uses different colors to draw the fundamental component, the harmonics, and the DC level and noise. The THD appears above the plot. The fundamental and harmonics are labeled. The DC term is excluded from the measurement and is not labeled.

Examples

Determine THD for a Signal with Two Harmonics

This example shows explicitly how to calculate the total harmonic distortion in dBc for a signal consisting of the fundamental and two harmonics. The explicit calculation is checked against the result returned by `thd`.

Create a signal sampled at 1 kHz. The signal consists of a 100 Hz fundamental with amplitude 2 and two harmonics at 200 and 300 Hz with amplitudes 0.01 and 0.005. Obtain the total harmonic distortion explicitly and using `thd`.

```
t = 0:0.001:1-0.001;
x = 2*cos(2*pi*100*t)+0.01*cos(2*pi*200*t)+0.005*cos(2*pi*300*t);
tharmdist = 10*log10((0.01^2+0.005^2)/2^2)

tharmdist = -45.0515

r = thd(x)

r = -45.0515
```

Specify Number of Harmonics

Create a signal sampled at 1 kHz. The signal consists of a 100 Hz fundamental with amplitude 2 and three harmonics at 200, 300, and 400 Hz with amplitudes 0.01, 0.005, and 0.0025.

Set the number of harmonics to 3. This includes the fundamental. Accordingly, the power at 100, 200, and 300 Hz is used in the THD calculation.

```
t = 0:0.001:1-0.001;  
x = 2*cos(2*pi*100*t)+0.01*cos(2*pi*200*t)+ ...  
    0.005*cos(2*pi*300*t)+0.0025*sin(2*pi*400*t);  
r = thd(x,1000,3)  
  
r = -45.0515
```

Specifying the number of harmonics equal to 3 ignores the power at 400 Hz in the THD calculation.

Specify Number of Harmonics (PSD Input)

Create a signal sampled at 1 kHz. The signal consists of a 100 Hz fundamental with amplitude 2 and three harmonics at 200, 300, and 400 Hz with amplitudes 0.01, 0.005, and 0.0025.

Obtain the periodogram PSD estimate of the signal and use the PSD estimate as the input to thd. Set the number of harmonics to 3. This includes the fundamental. Accordingly, the power at 100, 200, and 300 Hz is used in the THD calculation.

```
t = 0:0.001:1-0.001;  
fs = 1000;  
x = 2*cos(2*pi*100*t)+0.01*cos(2*pi*200*t)+ ...  
    0.005*cos(2*pi*300*t)+0.0025*sin(2*pi*400*t);  
[pxx,f] = periodogram(x,rectwin(length(x)),length(x),fs);  
r = thd(pxx,f,3,'psd')  
  
r = -45.0515
```

THD from Power Spectrum

Determine the THD by inputting the power spectrum obtained with a Hamming window and the resolution bandwidth of the window.

Create a signal sampled at 10 kHz. The signal consists of a 100 Hz fundamental with amplitude 2 and three odd-numbered harmonics at 300, 500, and 700 Hz with amplitudes 0.01, 0.005, and 0.0025. Specify the number of harmonics to 7. Determine the THD.

```
fs = 10000;
t = 0:1/fs:1-1/fs;
x = 2*cos(2*pi*100*t)+0.01*cos(2*pi*300*t)+ ...
    0.005*cos(2*pi*500*t)+0.0025*sin(2*pi*700*t);
[sxx,f] = periodogram(x,hamming(length(x)),length(x),fs,'power');
rbw = enbw(hamming(length(x)),fs);
r = thd(sxx,f,rbw,7,'power')

r = -44.8396
```

THD with and Without Aliased Harmonics

Generate a signal that resembles the output of a weakly nonlinear amplifier with a 2.1 kHz tone as input. The signal is sampled for 1 second at 10 kHz. Compute and plot the power spectrum of the signal. Use a Kaiser window with $\beta = 38$ for the computation.

```
Fs = 10000;
f = 2100;

t = 0:1/Fs:1;
x = tanh(sin(2*pi*f*t)+0.1) + 0.001*randn(1,length(t));

periodogram(x,kaiser(length(x),38),[],Fs,'power')
```

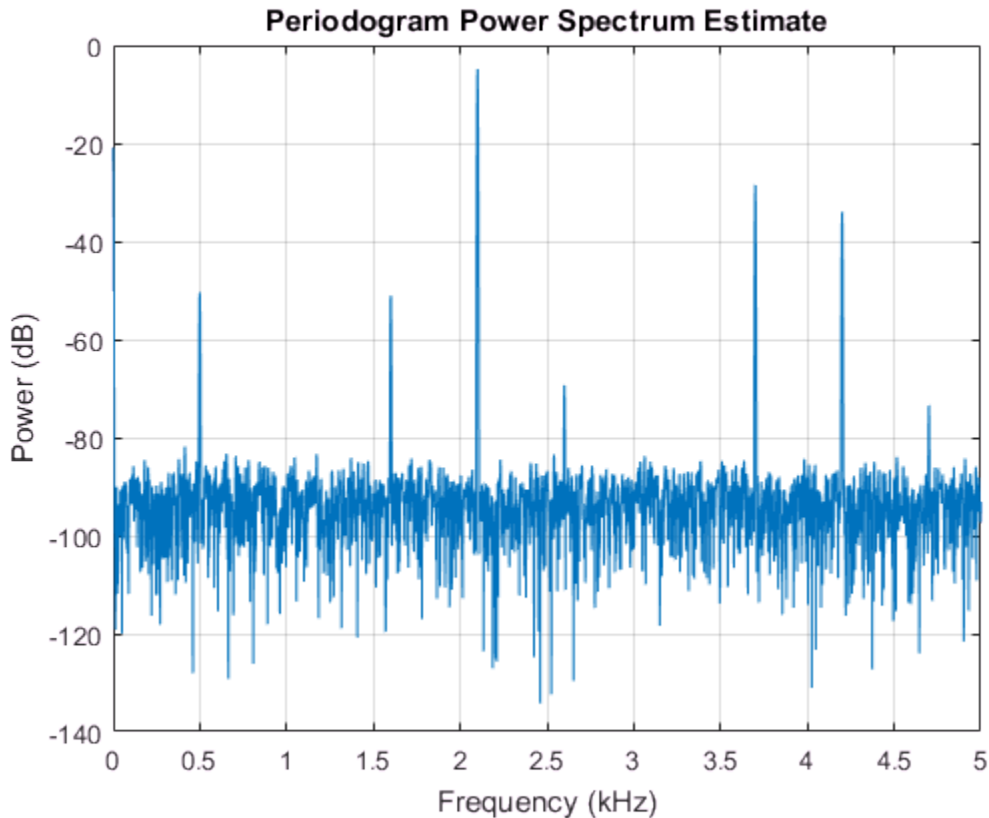

Harmonics stick out from the noise at frequencies of 4.2 kHz, 6.3 kHz, 8.4 kHz, 10.5 kHz, 12.6 kHz, and 14.7 kHz. All frequencies except for the first one are greater than the Nyquist frequency. The harmonics are aliased respectively into 3.7 kHz, 1.6 kHz, 0.5 kHz, 2.6 kHz, and 4.7 kHz.

Compute the total harmonic distortion of the signal. By default, `thd` treats the aliased harmonics as part of the noise.

```
thd(x,Fs,7);
```

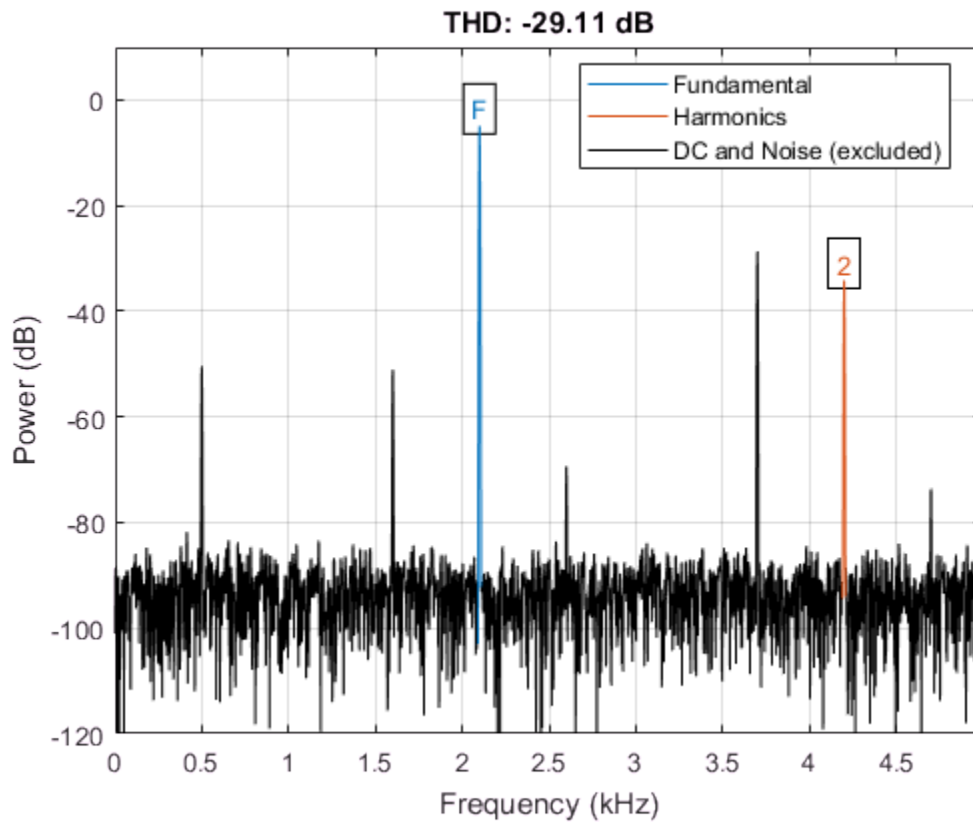

Repeat the computation, but now treat the aliased harmonics as part of the signal.

```
thd(x,Fs,7,'aliased');
```

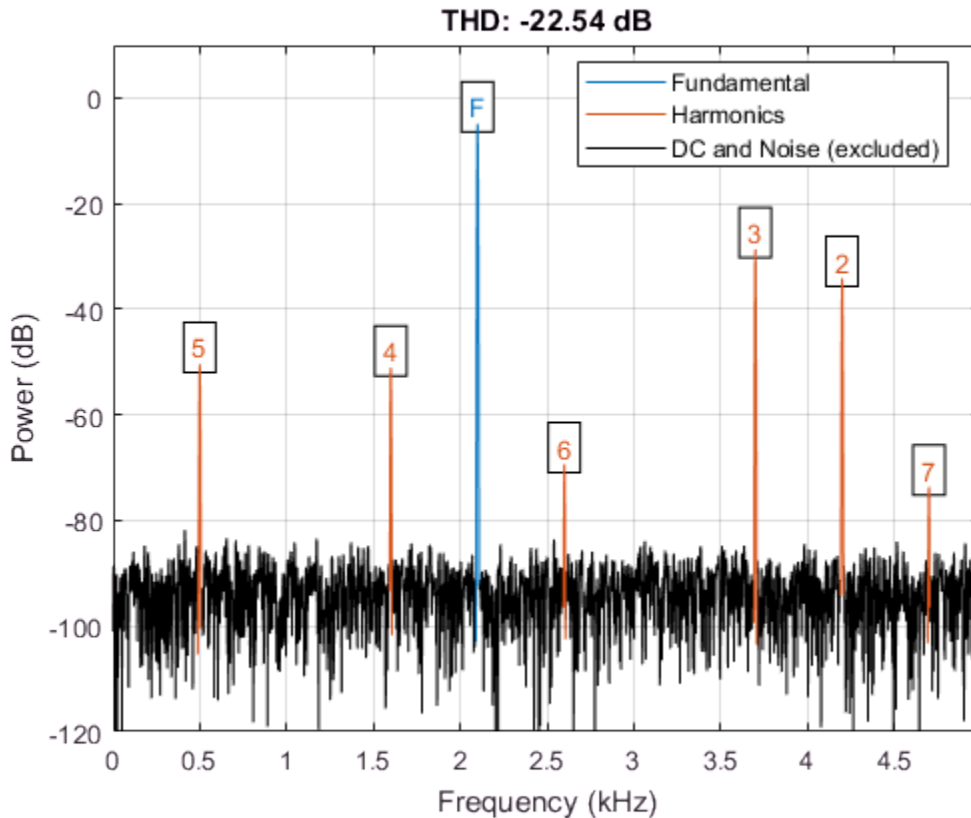

Harmonic Powers and Corresponding Frequencies

Create a signal sampled at 10 kHz. The signal consists of a 100 Hz fundamental with amplitude 2 and three odd-numbered harmonics at 300, 500, and 700 Hz with amplitudes 0.01, 0.005, and 0.0025. Specify the number of harmonics to 7. Determine the THD, the power at the harmonics, and the corresponding frequencies.

```
fs = 10000;
t = 0:1/fs:1-1/fs;
x = 2*cos(2*pi*100*t)+0.01*cos(2*pi*300*t)+ ...
    0.005*cos(2*pi*500*t)+0.0025*sin(2*pi*700*t);
[r,harmpow,harmfreq] = thd(x,10000,7);
```

```
[harmfreq harmpow]
```

```
ans =
```

```
100.0000    3.0103
201.0000 -320.4988
300.0000  -43.0103
399.0000 -281.9553
500.0000  -49.0309
599.0000 -282.0726
700.0000  -55.0515
```

The powers at the even-numbered harmonics are on the order of -300 dB, which corresponds to an amplitude of 10^{-15} .

THD of an Amplified Signal

Generate a sinusoid of frequency 2.5 kHz sampled at 50 kHz. Add Gaussian white noise with standard deviation 0.00005 to the signal. Pass the result through a weakly nonlinear amplifier. Plot the THD.

```
fs = 5e4;
f0 = 2.5e3;
N = 1024;
t = (0:N-1)/fs;

ct = cos(2*pi*f0*t);
cd = ct + 0.00005*randn(size(ct));

amp = [1e-5 5e-6 -1e-3 6e-5 1 25e-3];
sgn = polyval(amp,cd);
thd(sgn,fs);
```

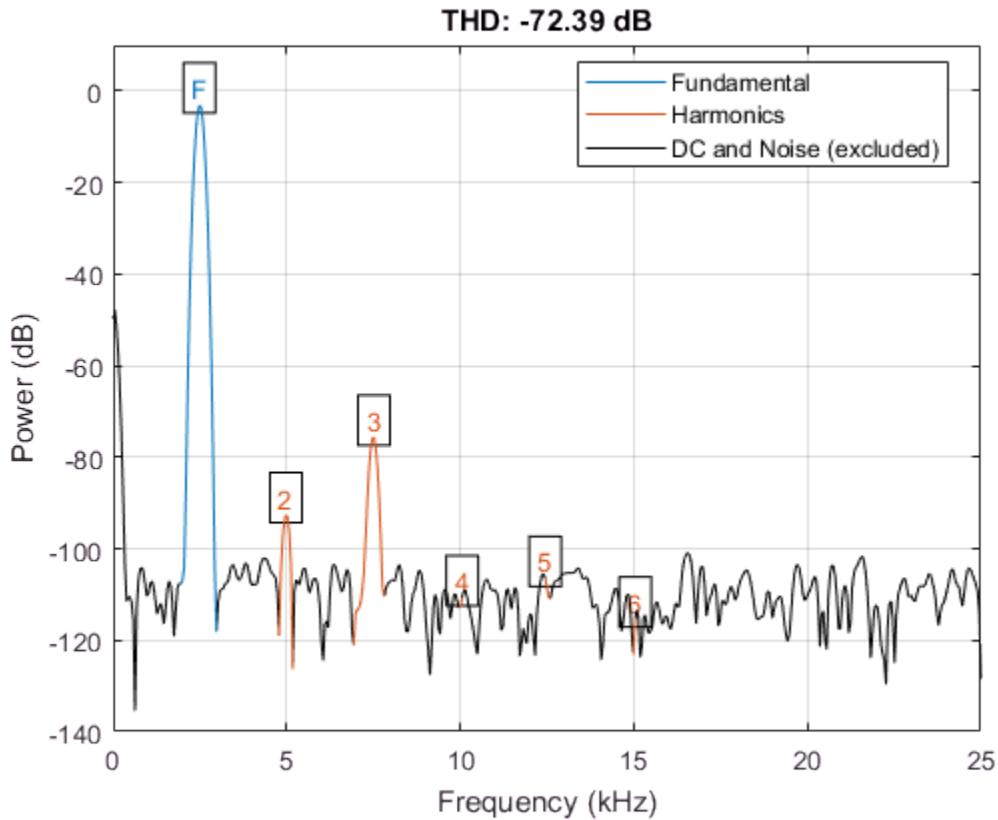

The plot shows the spectrum used to compute the ratio and the region treated as noise. The DC level is excluded from the computation. The fundamental and harmonics are labeled.

- “Analyzing Harmonic Distortion”

Input Arguments

x — Real-valued sinusoidal input signal
vector

Real-valued sinusoidal input signal, specified as a row or column vector.

Example: `cos(pi/4*(0:159))+cos(pi/2*(0:159))`

Data Types: `single` | `double`

fs — Sample rate

positive scalar

Sample rate, specified as a positive scalar. The sample rate is the number of samples per unit time. If the unit of time is seconds, then the sample rate has units of Hz.

n — Number of harmonics

positive integer

Number of harmonics, specified as a positive integer.

pxx — One-sided PSD estimate

vector

One-sided PSD estimate, specified as a real-valued, nonnegative column vector.

Data Types: `single` | `double`

f — Cyclical frequencies

vector

Cyclical frequencies corresponding to the one-sided PSD estimate, `pxx`, specified as a row or column vector. The first element of `f` must be 0.

Data Types: `double` | `single`

sxx — Power spectrum

nonnegative real-valued row or column vector

Power spectrum, specified as a real-valued nonnegative row or column vector.

rbw — Resolution bandwidth

positive scalar

Resolution bandwidth, specified as a positive scalar. The resolution bandwidth is the product of the frequency resolution of the discrete Fourier transform and the equivalent noise bandwidth of the window.

Output Arguments

r — Total harmonic distortion in dBc

real-valued scalar

Total harmonic distortion in dBc, returned as a real-valued scalar.

harmpow — Power of the harmonics

real-valued scalar or vector

Power of the harmonics, returned as a real-valued scalar or vector expressed in dB. Whether `harmpow` is a scalar or a vector depends on the number of harmonics you specify as the input argument `n`.

harmfreq — Frequencies of the harmonics

nonnegative scalar or vector

Frequencies of the harmonics, returned as a nonnegative scalar or vector. Whether `harmfreq` is a scalar or a vector depends on the number of harmonics you specify as the input argument `n`.

Definitions

Distortion Measurement Functions

The functions `thd`, `sfdR`, `sinad`, and `snr` measure the response of a weakly nonlinear system stimulated by a sinusoid.

When given time-domain input, `thd` performs a periodogram using a Kaiser window with large sidelobe attenuation. To find the fundamental frequency, the algorithm searches the periodogram for the largest nonzero spectral component. It then computes the central moment of all adjacent bins that decrease monotonically away from the maximum. To be detectable, the fundamental should be at least in the second frequency bin. Higher harmonics are at integer multiples of the fundamental frequency. If a harmonic lies within the monotonically decreasing region in the neighborhood of another, its power is considered to belong to the larger harmonic. This larger harmonic may or may not be the fundamental.

`thd` fails if the fundamental is not the highest spectral component in the signal.

Ensure that the frequency components are far enough apart to accommodate for the sidelobe width of the Kaiser window. If this is not feasible, you can use the 'power' flag and compute a periodogram with a different window.

See Also

See Also

`sfdr` | `sinad` | `snr` | `toi`

Topics

“Analyzing Harmonic Distortion”

Introduced in R2013b

toi

Third-order intercept point

Syntax

```
oip3 = toi(x)  
oip3 = toi(x,fs)
```

```
oip3 = toi(pxx,f,'psd')  
oip3 = toi(sxx,f,rbw,'power')
```

```
[oip3,fundpow,fundfreq,imodpow,imodfreq] = toi( ___ )
```

```
toi( ___ )
```

Description

`oip3 = toi(x)` returns the output third-order intercept (TOI) point, in decibels (dB), of a real sinusoidal two-tone input signal, `x`. The computation is performed over a periodogram of the same length as the input using a Kaiser window with $\beta = 38$.

`oip3 = toi(x,fs)` specifies the sample rate, `fs`. The default value of `fs` is 1.

`oip3 = toi(pxx,f,'psd')` specifies the input as a one-sided power spectral density (PSD), `pxx`, of a real signal. `f` is a vector of frequencies that corresponds to the vector of `pxx` estimates.

`oip3 = toi(sxx,f,rbw,'power')` specifies the input as a one-sided power spectrum, `sxx`, of a real signal. `rbw` is the resolution bandwidth over which each power estimate is integrated.

`[oip3,fundpow,fundfreq,imodpow,imodfreq] = toi(___)` also returns the power, `fundpow`, and frequencies, `fundfreq`, of the two fundamental sinusoids. It also returns the power, `imodpow`, and frequencies, `imodfreq`, of the lower and upper intermodulation products. This syntax can use any of the input arguments in the preceding syntaxes.

`toi(___)` with no output arguments plots the spectrum of the signal and annotates the lower and upper fundamentals (f_1, f_2) and intermodulation products ($2f_1 - f_2, 2f_2 - f_1$). Higher harmonics and intermodulation products are not labeled. The TOI appears above the plot.

Examples

Third-Order Intercept Point of a Two-Tone Nonlinear Signal with Noise

Create a two-tone sinusoid with frequencies $f_1 = 5$ kHz and $f_2 = 6$ kHz, sampled at 48 kHz. Make the signal nonlinear by feeding it to a polynomial. Add noise. Set the random number generator to the default settings for reproducible results. Compute the third-order intercept point. Verify that the intermodulation products occur at $2f_2 - f_1 = 4$ kHz and $2f_1 - f_2 = 7$ kHz.

```
rng default
fi1 = 5e3;
fi2 = 6e3;
Fs = 48e3;
N = 1000;
x = sin(2*pi*fi1/Fs*(1:N))+sin(2*pi*fi2/Fs*(1:N));
y = polyval([0.5e-3 1e-7 0.1 3e-3],x)+1e-5*randn(1,N);

[myTOI,Pfund,Ffund,Pim3,Fim3] = toi(y,Fs);
myTOI,Fim3

myTOI = 1.3844

Fim3 =

    1.0e+03 *
    4.0002    6.9998
```

Third-Order Intercept Point from Power Spectral Density

Create a two-tone sinusoid with frequencies 5 kHz and 6 kHz, sampled at 48 kHz. Make the signal nonlinear by evaluating a polynomial. Add noise. Set the random number generator to the default settings for reproducible results.

```
rng default
fi1 = 5e3;
fi2 = 6e3;
Fs = 48e3;
N = 1000;
x = sin(2*pi*fi1/Fs*(1:N))+sin(2*pi*fi2/Fs*(1:N));
y = polyval([0.5e-3 1e-7 0.1 3e-3],x)+1e-5*randn(1,N);
```

Evaluate the periodogram of the signal using a Kaiser window. Compute the TOI using the power spectral density. Plot the result.

```
w = kaiser(numel(y),38);

[Sxx, F] = periodogram(y,w,N,Fs,'psd');
[myTOI,Pfund,Ffund,Pim3,Fim3] = toi(Sxx,F,'psd')

myTOI = 1.3843

Pfund =

    -22.9133    -22.9132

Ffund =

    1.0e+03 *
    5.0000    6.0000

Pim3 =

    -71.4868    -71.5299

Fim3 =

    1.0e+03 *
    4.0002    6.9998

toi(Sxx,F,'psd');
```

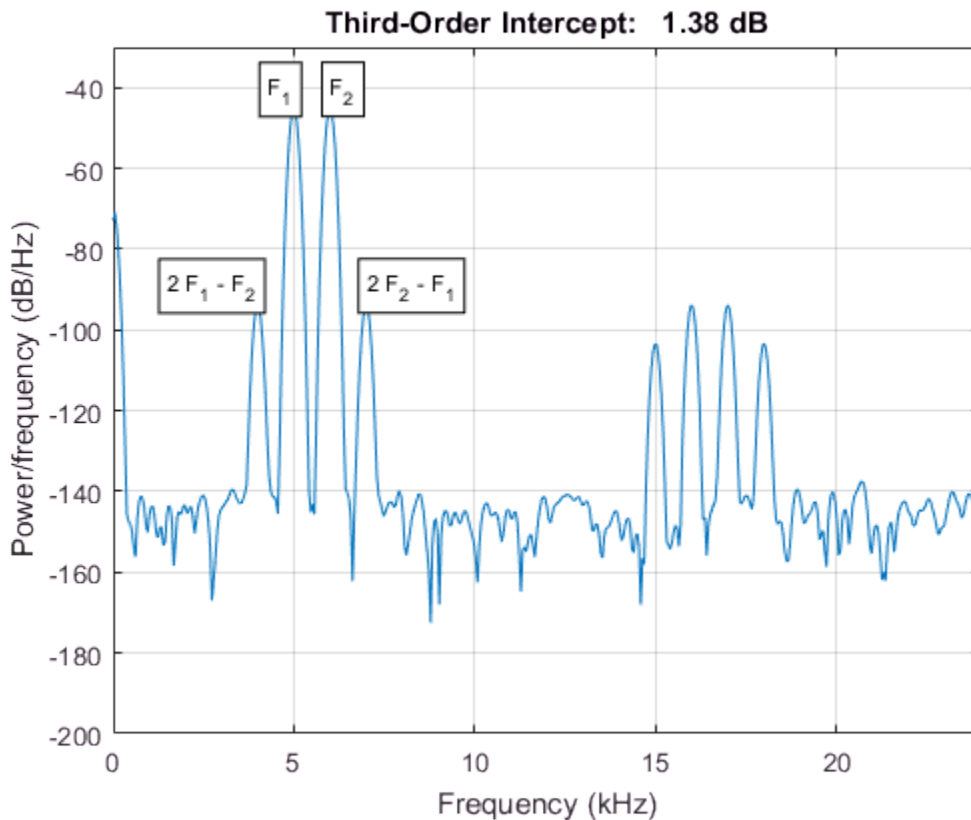

Third-Order Intercept Point from Power Spectrum

Create a two-tone sinusoid with frequencies 5 kHz and 6 kHz, sampled at 48 kHz. Make the signal nonlinear by evaluating a polynomial. Add noise. Set the random number generator to the default settings for reproducible results.

```
rng default
```

```
fi1 = 5e3;  
fi2 = 6e3;  
Fs = 48e3;  
N = 1000;
```

```
x = sin(2*pi*fi1/Fs*(1:N))+sin(2*pi*fi2/Fs*(1:N));
y = polyval([0.5e-3 1e-7 0.1 3e-3],x)+1e-5*randn(1,N);
```

Evaluate the periodogram of the signal using a Kaiser window. Compute the TOI using the power spectrum. Plot the result.

```
w = kaiser(numel(y),38);
[Sxx,F] = periodogram(y,w,N,Fs,'power');
toi(Sxx,F,enbw(w,Fs),'power')
ans = 1.3844
```

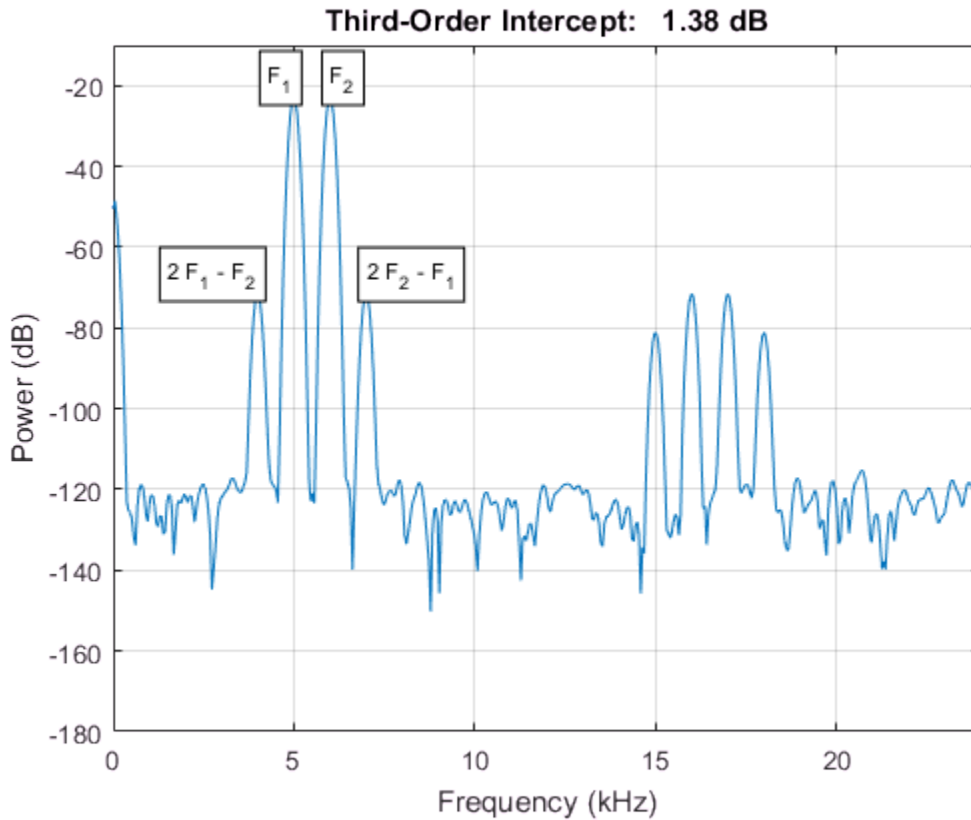

Intermodulation Distortion Products

Generate 640 samples of a two-tone sinusoid with frequencies 5 Hz and 7 Hz, sampled at 32 Hz. Make the signal nonlinear by evaluating a polynomial. Add noise with standard deviation 0.01. Set the random number generator to the default settings for reproducible results. Compute the third-order intercept point. Verify that the intermodulation

products occur at $2f_2 - f_1 = 9$ Hz and $2f_1 - f_2 = 3$ Hz.

```
rng default
x = sin(2*pi*5/32*(1:640))+cos(2*pi*7/32*(1:640));
q = x + 0.01*x.^3 + 1e-2*randn(size(x));
[myTOI,Pfund,Ffund,Pim3,Fim3] = toi(q,32)
```

```
myTOI = 17.4230
```

```
Pfund =
```

```
    -2.8350    -2.8201
```

```
Ffund =
```

```
    5.0000    7.0001
```

```
Pim3 =
```

```
   -43.1362   -43.5211
```

```
Fim3 =
```

```
    3.0015    8.9744
```

TOI Plot

Generate 640 samples of a two-tone sinusoid with frequencies 5 Hz and 7 Hz, sampled at 32 Hz. Make the signal nonlinear by evaluating a polynomial. Add noise with standard deviation 0.01. Set the random number generator to the default settings. Plot the spectrum of the signal. Display the fundamentals and the intermodulation products. Verify that the latter occur at 9 Hz and 3 Hz.

```
rng default
```

```
x = sin(2*pi*5/32*(1:640))+cos(2*pi*7/32*(1:640));
q = x + 0.01*x.^3 + 1e-2*randn(size(x));
toi(q,32)

ans = 17.4230
```

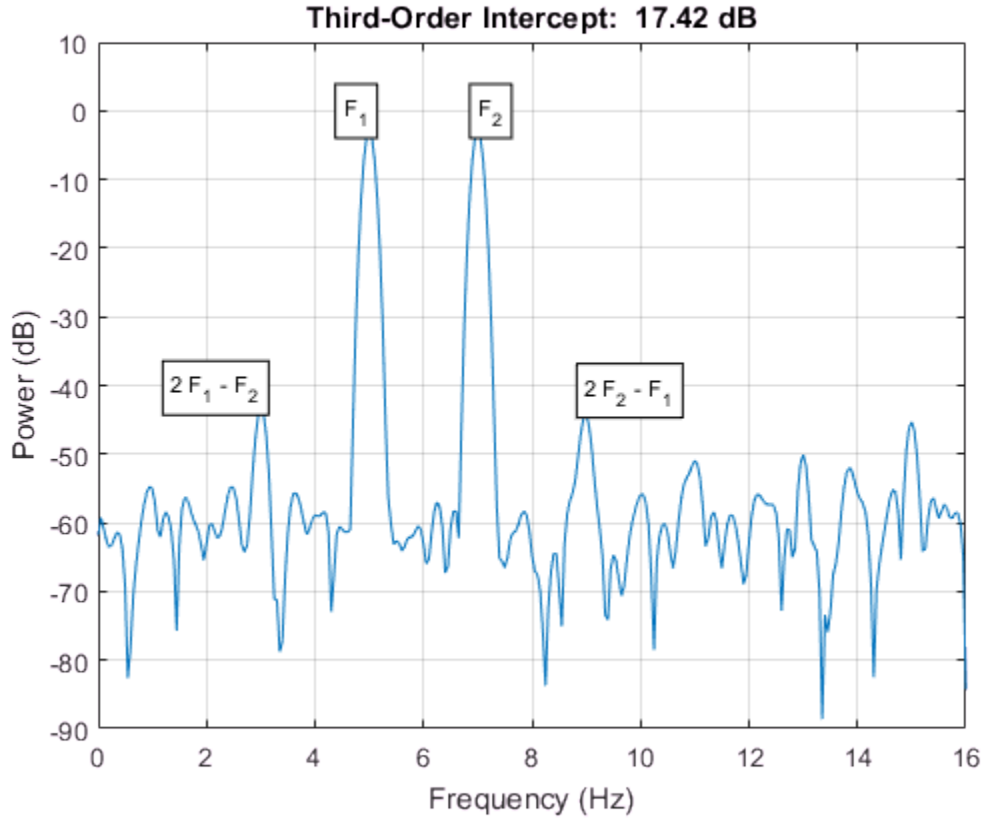

Input Arguments

x — Real-valued sinusoidal two-tone signal
vector

Real-valued sinusoidal two-tone signal, specified as a row or column vector.

Example: `polyval([0.01 0 1 0],sum(sin(2*pi*[5 7]'.*(1:640)/32))) + 0.01*randn([1 640])`

Data Types: `double` | `single`

fs — Sample rate

1 (default) | positive real scalar

Sample rate, specified as a positive real scalar. The sample rate is the number of samples per unit time. If the unit of time is seconds, then the sample rate has units of hertz.

Data Types: `double` | `single`

pxx — One-sided PSD estimate

vector

One-sided power spectral density estimate, specified as a real-valued, nonnegative row or column vector.

Data Types: `double` | `single`

f — Cyclical frequencies

vector

Cyclical frequencies corresponding to the one-sided PSD estimate, `pxx`, specified as a row or column vector. The first element of `f` must be 0.

Data Types: `double` | `single`

sxx — Power spectrum

nonnegative real-valued row or column vector

Power spectrum, specified as a real-valued nonnegative row or column vector.

Data Types: `double` | `single`

rbw — Resolution bandwidth

positive scalar

Resolution bandwidth, specified as a positive scalar. The resolution bandwidth is the product of the frequency resolution of the discrete Fourier transform and the equivalent noise bandwidth of the window.

Data Types: `double` | `single`

Output Arguments

oip3 — Third-order intercept point

scalar

Output third-order intercept point of a sinusoidal two-tone signal, returned as a real-valued scalar expressed in decibels. If the second primary tone is the second harmonic of the first primary tone, then the lower intermodulation product is at zero frequency. The function returns NaN in those cases.

Data Types: `double` | `single`

fundpow — Power of fundamental sinusoids

two-element real row vector

Power contained in the two fundamental sinusoids of the input signal, returned as a real-valued two-element row vector.

Data Types: `double` | `single`

fundfreq — Frequencies of fundamental sinusoids

two-element real row vector

Frequencies of the two fundamental sinusoids of the input signal, returned as a real-valued two-element row vector.

Data Types: `double` | `single`

imodpow — Power of intermodulation products

two-element real row vector

Power contained in the lower and upper intermodulation products of the input signal, returned as a real-valued two-element row vector.

Data Types: `double` | `single`

imodfreq — Frequencies of intermodulation products

two-element real row vector

Frequencies of the lower and upper intermodulation products of the input signal, returned as a real-valued two-element row vector.

Data Types: `double` | `single`

References

- [1] Kundert, Kenneth S. “Accurate and Rapid Measurement of IP_2 and IP_3 .” May, 2002.
<http://www.designers-guide.org/Analysis/intercept-point.pdf>.

See Also

See Also

sfdr | sinad | snr | thd

Introduced in R2013b

triang

Triangular window

Syntax

```
w = triang(L)
```

Description

`w = triang(L)` returns an L-point triangular window in the column vector, `w`.

See “Algorithms” on page 1-2433 for the equations that define the triangular window. The triangular window is very similar to a Bartlett window. The Bartlett window always ends with zeros at samples 1 and L, while the triangular window is nonzero at those points. For L odd, the center L-2 points of `triang(L-2)` are equivalent to `bartlett(L)`.

Examples

Triangular Window

Create a 200-point triangular window. Display the result using `wvtool`.

```
L = 200;  
w = triang(L);  
wvtool(w)
```

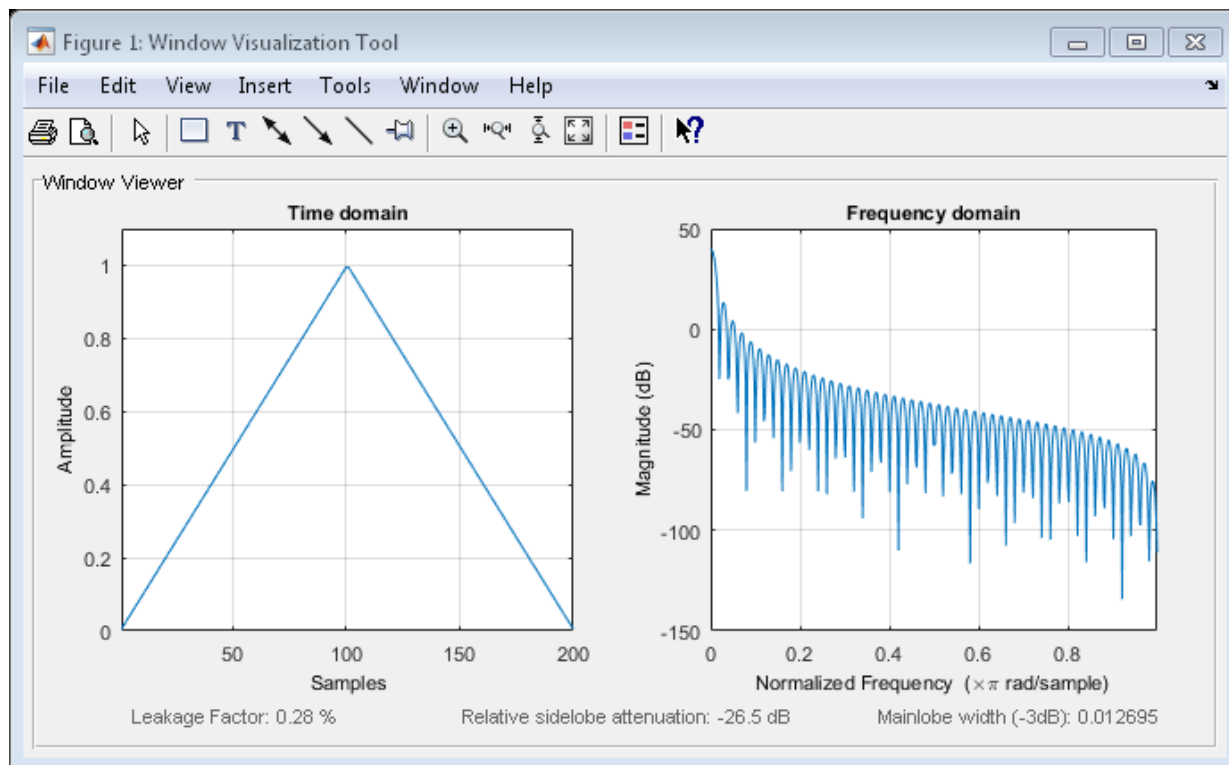

Algorithms

The coefficients of a triangular window are the following.

For L odd:

$$w(n) = \begin{cases} \frac{2n}{L+1} & 1 \leq n \leq (L+1)/2 \\ 2 - \frac{2n}{L+1} & (L+1)/2 + 1 \leq n \leq L \end{cases}$$

For L even:

$$w(n) = \begin{cases} \frac{(2n-1)}{L} & 1 \leq n \leq L/2 \\ 2 - \frac{(2n-1)}{L} & L/2+1 \leq n \leq L \end{cases}$$

References

- [1] Oppenheim, Alan V., Ronald W. Schaffer, and John R. Buck. *Discrete-Time Signal Processing*. Upper Saddle River, NJ: Prentice Hall, 1999.

Extended Capabilities

C/C++ Code Generation

Generate C and C++ code using MATLAB® Coder™.

Usage notes and limitations:

All inputs must be constant. Expressions or variables are allowed if their values do not change.

See Also

See Also

Apps

Window Designer

Functions

barthannwin | bartlett | blackmanharris | bohmanwin | nuttallwin |
parzenwin | rectwin | window | wvtool

Introduced before R2006a

tripuls

Sampled aperiodic triangle

Syntax

```
y = tripuls(T)
y = tripuls(T,w)
y = tripuls(T,w,s)
```

Description

`y = tripuls(T)` returns a continuous, aperiodic, symmetric, unity-height triangular pulse at the times indicated in array `T`, centered about `T=0` and with a default width of 1.

`y = tripuls(T,w)` generates a triangular pulse of width `w`.

`y = tripuls(T,w,s)` generates a triangular pulse with skew `s`, where $-1 \leq s \leq 1$. When `s` is 0, a symmetric triangular pulse is generated.

Examples

Generate and Displace Triangular Pulse

Generate 200 ms of a symmetric triangular pulse with a sample rate of 10 kHz and a width of 40 ms.

```
fs = 10e3;
t = -0.1:1/fs:0.1;

w = 40e-3;

x = tripuls(t,w);
```

Generate two variations of the same pulse:

- One displaced 45 ms into the past and skewed 45% to the left.

```
tpast = -45e-3;  
spast = -0.45;  
xpast = tripuls(t-tpast,w,spast);
```

- One displaced 60 ms into the future, half as wide, and skewed completely to the right.

```
tfutr = 60e-3;  
sfutr = 1;  
xfutr = tripuls(t-tfutr,w/2,sfutr);
```

Plot the original pulse and the two copies on the same axes.

```
plot(t,x,t,xpast,t,xfutr)  
ylim([-0.2 1.2])
```

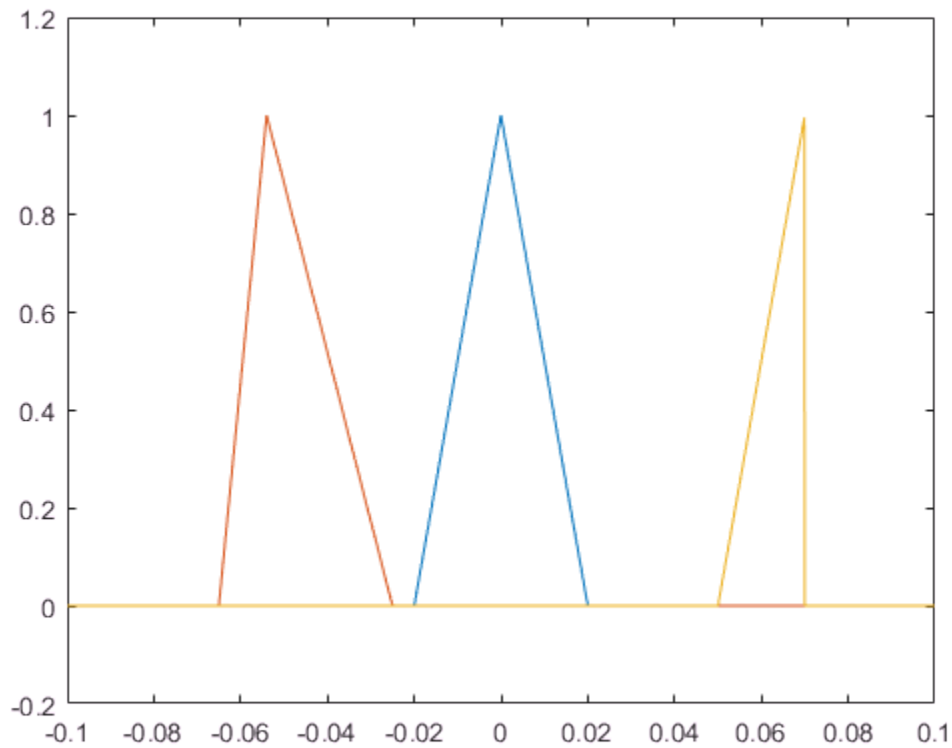

See Also

chirp | cos | diric | gauspuls | pulstran | rectpuls | sawtooth | sin | square

Introduced before R2006a

tukeywin

Tukey (tapered cosine) window

Syntax

```
w = tukeywin(L,r)
```

Description

`w = tukeywin(L,r)` returns an L-point Tukey window in the column vector, `w`. A Tukey window is a rectangular window with the first and last $r/2$ percent of the samples equal to parts of a cosine. See “Algorithms” on page 1-2439 for the equation that defines the Tukey window. `r` is a real number between 0 and 1. If you input $r \leq 0$, you obtain a `rectwin` window. If you input $r \geq 1$, you obtain a `hann` window. `r` defaults to 0.5.

Examples

Tukey Windows

Compute 128-point Tukey windows with five different values of `r`, or "tapers." Display the results using `wvtool`.

```
L = 128;
t0 = tukeywin(L,0);           % Equivalent to a rectangular window
t25 = tukeywin(L,0.25);      %
t5 = tukeywin(L);            % r = 0.5
t75 = tukeywin(L,0.75);      %
t1 = tukeywin(L,1);          % Equivalent to a Hann window
wvtool(t0,t25,t5,t75,t1)
```

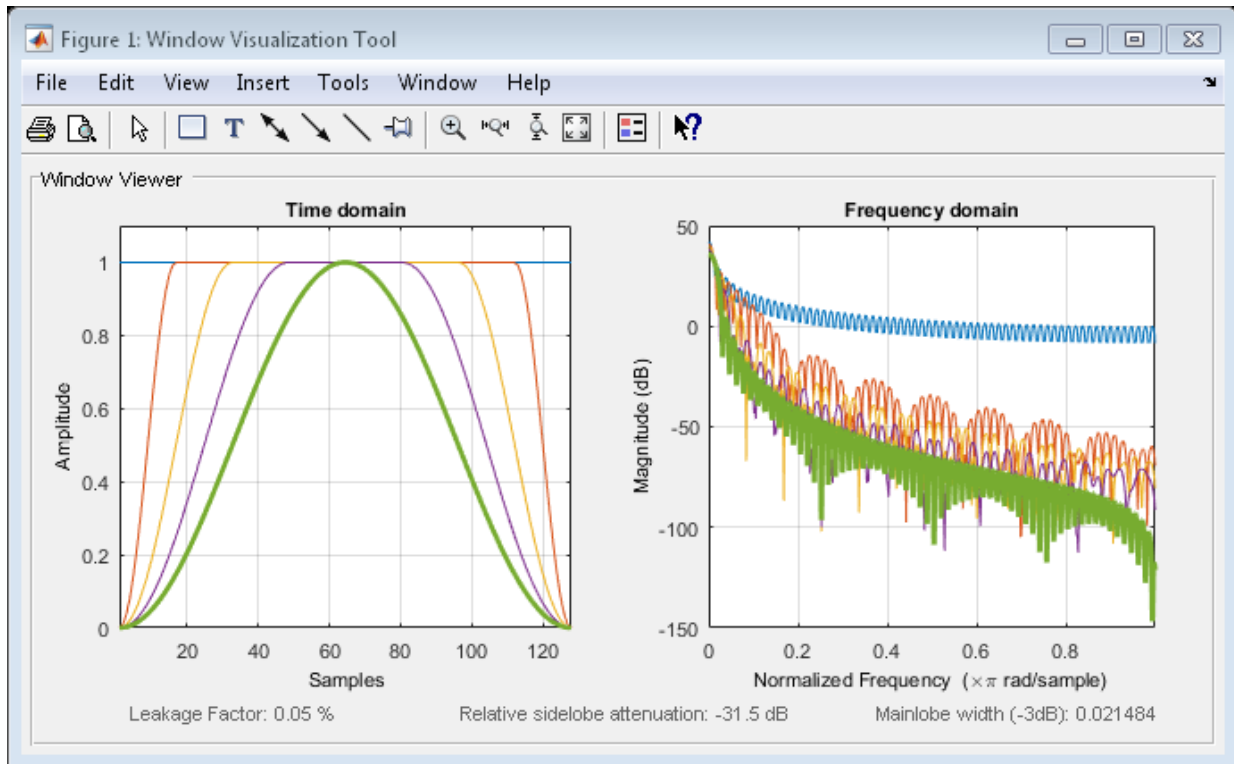

Algorithms

The following equation defines the L -point Tukey window:

$$w(x) = \begin{cases} \frac{1}{2} \{1 + \cos(\frac{2\pi}{r} [x - r/2])\}, & 0 \leq x < \frac{r}{2} \\ 1, & \frac{r}{2} \leq x < 1 - \frac{r}{2} \\ \frac{1}{2} \{1 + \cos(\frac{2\pi}{r} [x - 1 + r/2])\}, & 1 - \frac{r}{2} \leq x \leq 1 \end{cases}$$

where x is an L -point linearly spaced vector generated using `linspace`. The parameter r is the ratio of cosine-tapered section length to the entire window length with $0 \leq r \leq 1$.

For example, setting $r = 0.5$ produces a Tukey window where $1/2$ of the entire window length consists of segments of a phase-shifted cosine with period $2r = 1$. If you specify $r \leq 0$, an L -point rectangular window is returned. If you specify $r \geq 1$, an L -point von Hann window is returned.

References

- [1] Bloomfield, P. *Fourier Analysis of Time Series: An Introduction*. New York: Wiley-Interscience, 2000.

Extended Capabilities

C/C++ Code Generation

Generate C and C++ code using MATLAB® Coder™.

Usage notes and limitations:

All inputs must be constant. Expressions or variables are allowed if their values do not change.

See Also

See Also

Apps

Window Designer

Functions

`chebwin` | `gausswin` | `kaiser` | `window` | `wvtool`

Introduced before R2006a

udecode

Decode 2^n -level quantized integer inputs to floating-point outputs

Syntax

```
y = udecode(u, n)
y = udecode(u, n, v)
y = udecode(u, n, v, 'SaturateMode')
```

Description

`y = udecode(u, n)` inverts the operation of `uencode` and reconstructs quantized floating-point values from an encoded multidimensional array of integers `u`. The input argument `n` must be an integer between 2 and 32. The integer `n` specifies that there are 2^n quantization levels for the inputs, so that entries in `u` must be either:

- Signed integers in the range $[-2^{n/2}, (2^{n/2}) - 1]$
- Unsigned integers in the range $[0, 2^n - 1]$

Inputs can be real or complex values of any integer data type (`uint8`, `uint16`, `uint32`, `int8`, `int16`, `int32`). Overflows (entries in `u` outside of the ranges specified above) are saturated to the endpoints of the range interval. The output `y` has the same dimensions as `u`. Its entries have values in the range $[-1, 1]$.

`y = udecode(u, n, v)` decodes `u` such that the output `y` has values in the range $[-v, v]$, where the default value for `v` is 1.

`y = udecode(u, n, v, 'SaturateMode')` decodes `u` and treats input overflows (entries in `u` outside of $[-v, v]$) according to `'saturatemode'`, which can be set to one of the following:

- `'saturate'` — Saturate overflows. This is the default method for treating overflows.
- Entries in signed inputs `u` whose values are outside of the range $[-2^{n/2}, (2^{n/2}) - 1]$ are assigned the value determined by the closest endpoint of this interval.

- Entries in unsigned inputs u whose values are outside of the range $[0, 2^n-1]$ are assigned the value determined by the closest endpoint of this interval.
- 'wrap' — Wrap all overflows according to the following:
 - Entries in signed inputs u whose values are outside of the range $[-2^n/2, (2^n/2) - 1]$ are wrapped back into that range using modulo 2^n arithmetic (calculated using $u = \text{mod}(u+2^n/2, 2^n) - (2^n/2)$).
 - Entries in unsigned inputs u whose values are outside of the range $[0, 2^n - 1]$ are wrapped back into the required range before decoding using modulo 2^n arithmetic (calculated using $u = \text{mod}(u, 2^n)$).

Examples

Use udecode to Decode Integers

Create a vector of 8-bit signed integers. Decode with three bits.

```
u = int8([-1 1 2 -5]);  
ysat = udecode(u,3)  
  
ysat =  
    -0.2500    0.2500    0.5000   -1.0000
```

Notice the last entry in u saturates to 1, the default peak input magnitude. Change the peak input magnitude to 6.

```
ysatv = udecode(u,3,6)  
  
ysatv =  
    -1.5000    1.5000    3.0000   -6.0000
```

The last input entry still saturates. Wrap the overflows.

```
ywrap = udecode(u,3,6, 'wrap')  
  
ywrap =
```

-1.5000 1.5000 3.0000 4.5000

Add more quantization levels.

```
yprec = udecode(u,5)
```

```
yprec =
```

-0.0625 0.0625 0.1250 -0.3125

Algorithms

The algorithm adheres to the definition for uniform decoding specified in ITU-T Recommendation G.701. Integer input values are uniquely mapped (decoded) from one of 2^n uniformly spaced integer values to quantized floating-point values in the range $[-v, v]$. The smallest integer input value allowed is mapped to $-v$ and the largest integer input value allowed is mapped to v . Values outside of the allowable input range are either saturated or wrapped, according to specification.

The real and imaginary components of complex inputs are decoded independently.

References

- [1] International Telecommunication Union. *General Aspects of Digital Transmission Systems: Vocabulary of Digital Transmission and Multiplexing, and Pulse Code Modulation (PCM) Terms*. ITU-T Recommendation G.701. March, 1993.

See Also

uencode

Introduced before R2006a

uencode

Quantize and encode floating-point inputs to integer outputs

Syntax

```
y = uencode(u, n)
y = uencode(u, n, v)
y = uencode(u, n, v, 'SignFlag')
```

Description

`y = uencode(u, n)` quantizes the entries in a multidimensional array of floating-point numbers `u` and encodes them as integers using 2^n -level quantization. `n` must be an integer between 2 and 32 (inclusive). Inputs can be real or complex, double- or single-precision. The output `y` and the input `u` are arrays of the same size. The elements of the output `y` are unsigned integers with magnitudes in the range $[0, 2^n - 1]$. Elements of the input `u` outside of the range $[-1, 1]$ are treated as overflows and are saturated.

- For entries in the input `u` that are less than -1 , the value of the output of `uencode` is 0.
- For entries in the input `u` that are greater than 1 , the value of the output of `uencode` is $2^n - 1$.

`y = uencode(u, n, v)` allows the input `u` to have entries with floating-point values in the range $[-v, v]$ before saturating them (the default value for `v` is 1). Elements of the input `u` outside of the range $[-v, v]$ are treated as overflows and are saturated:

- For input entries less than $-v$, the value of the output of `uencode` is 0.
- For input entries greater than v , the value of the output of `uencode` is $2^n - 1$.

`y = uencode(u, n, v, 'SignFlag')` maps entries in a multidimensional array of floating-point numbers `u` whose entries have values in the range $[-v, v]$ to an integer output `y`. Input entries outside this range are saturated. The integer type of the output depends on the number of quantization levels 2^n and the value of `'SignFlag'`, which can be one of the following:

- 'signed': Outputs are signed integers with magnitudes in the range $[-2^{n/2}, (2^{n/2}) - 1]$.
- 'unsigned' (default): Outputs are unsigned integers with magnitudes in the range $[0, 2^n - 1]$.

The output data types are optimized for the number of bits as shown in the table below.

n	Unsigned Integer	Signed Integer
2 to 8	uint8	int8
9 to 16	uint16	int16
17 to 32	uint32	int32

Examples

Map Floating-Point Scalars to Integers

Map floating-point scalars in $[-1, 1]$ to `uint8` (unsigned) integers. Produce a staircase plot. The horizontal axis ranges from -1 to 1 and the vertical axis from 0 to 7 (i.e., $2^3 - 1$).

```
u = -1:0.01:1;
y = uencode(u,3);
plot(u,y, '.')
```

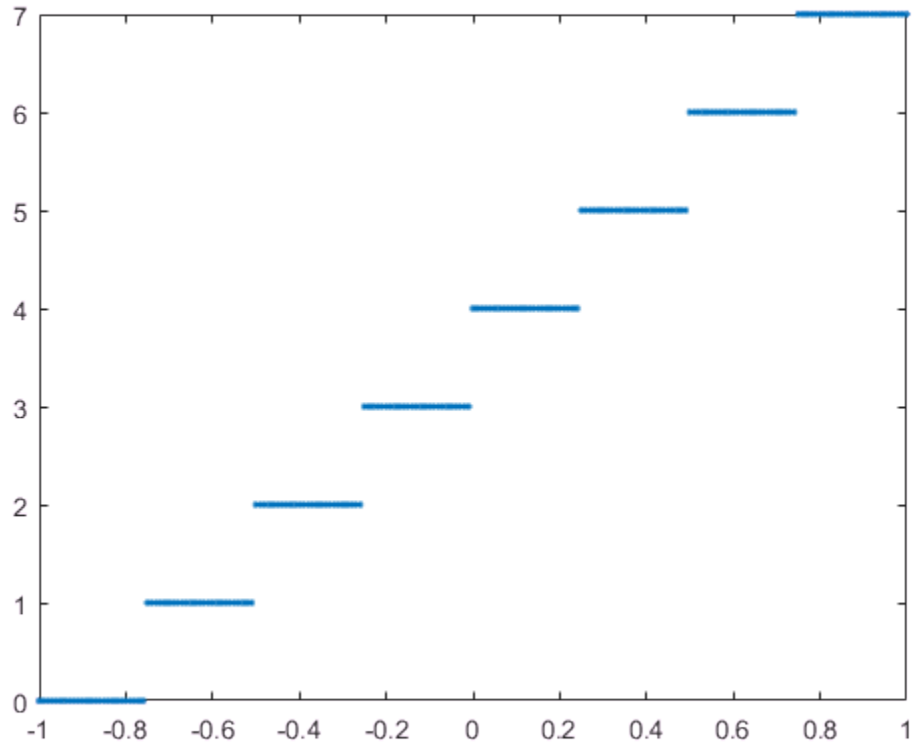

Look at saturation effects when you underspecify the peak value for the input.

```
u = -2:0.5:2;
y = uencode(u,5,1)
```

y = 1×9 uint8 row vector

```
0 0 0 8 16 24 31 31 31
```

Specify you want signed output.

```
u = -2:0.5:2;
y = uencode(u,5,2,'signed')
```

$y = 1 \times 9$ int8 row vector

-16 -12 -8 -4 0 4 8 12 15

Algorithms

uencode maps the floating-point input value to an integer value determined by the requirement for 2^n levels of quantization. This encoding adheres to the definition for uniform encoding specified in ITU-T Recommendation G.701. The input range $[-v, v]$ is divided into 2^n evenly spaced intervals. Input entries in the range $[-v, v]$ are first quantized according to this subdivision of the input range, and then mapped to one of 2^n integers. The range of the output depends on whether or not you specify that you want signed integers.

References

- [1] International Telecommunication Union. *General Aspects of Digital Transmission Systems: Vocabulary of Digital Transmission and Multiplexing, and Pulse Code Modulation (PCM) Terms*. ITU-T Recommendation G.701. March, 1993.

See Also

udecode

Introduced before R2006a

unshiftdata

Inverse of shiftdata

Syntax

```
y = unshiftdata(x,perm,nshifts)
```

Description

`y = unshiftdata(x,perm,nshifts)` restores the orientation of the data that was shifted with `shiftdata`. The permutation vector is given by `perm`, and `nshifts` is the number of shifts that was returned from `shiftdata`.

`unshiftdata` is meant to be used in tandem with `shiftdata`. These functions are useful for creating functions that work along a certain dimension, like `filter`, `goertzel`, `sgolayfilt`, and `sosfilt`.

Examples

Permute Dimensions of a Magic Square

This example shifts `x`, a 3-by-3 magic square, permuting dimension 2 to the first column. `unshiftdata` shifts `x` back to its original shape.

Create a 3-by-3 magic square.

```
x = magic(3)
```

```
x =
```

```
     8     1     6
     3     5     7
     4     9     2
```

Shift the matrix `x` to work along the second dimension. The permutation vector, `perm`, and the number of shifts, `nshifts`, are returned along with the shifted matrix.

```
[x,perm,nshifts] = shiftdata(x,2)
```

```
x =
```

```

     8     3     4
     1     5     9
     6     7     2

```

```
perm =
```

```

     2     1

```

```
nshifts =
```

```

     []

```

Shift the matrix back to its original shape.

```
y = unshiftdata(x,perm,nshifts)
```

```
y =
```

```

     8     1     6
     3     5     7
     4     9     2

```

Rearrange Array to Operate on First Nonsingleton Dimension

This example shows how `shiftdata` and `unshiftdata` work when you define `dim` as empty.

Define `x` as a row vector.

```
x = 1:5
```

```
x =
```

```

     1     2     3     4     5

```

Define `dim` as empty to shift the first non-singleton dimension of `x` to the first column. `shiftdata` returns `x` as a column vector, along with `perm`, the permutation vector, and `nshifts`, the number of shifts.

```
[x,perm,nshifts] = shiftdata(x,[])
```

```
x =
```

```
1  
2  
3  
4  
5
```

```
perm =
```

```
[]
```

```
nshifts = 1
```

Using `unshiftdata`, restore `x` to its original shape.

```
y = unshiftdata(x,perm,nshifts)
```

```
y =
```

```
1 2 3 4 5
```

See Also

`ipermute` | `shiftdata` | `shiftdim`

Introduced in R2012b

upfirdn

Upsample, apply FIR filter, and downsample

Syntax

```
yout = upfirdn(xin,h)  
yout = upfirdn(xin,h,p)  
yout = upfirdn(xin,h,p,q)
```

Description

upfirdn performs a cascade of three operations:

- 1 Upsampling the input data in the matrix *xin* by a factor of the integer *p* (inserting zeros)
- 2 FIR filtering the upsampled signal data with the impulse response sequence given in the vector or matrix *h*
- 3 Downsampling the result by a factor of the integer *q* (throwing away samples)

upfirdn has been implemented as a MEX-file for maximum speed, so only the outputs actually needed are computed. The FIR filter is usually a lowpass filter, which you must design using another function such as `firpm` or `fir1`.

Note The function `resample` performs an FIR design using `firls`, followed by rate changing implemented with `upfirdn`.

yout = upfirdn(*xin*,*h*) filters the input signal *xin* with the FIR filter having impulse response *h*. If *xin* is a row or column vector, then it represents a single signal. If *xin* is a matrix, then each column is filtered independently. If *h* is a row or column vector, then it represents one FIR filter. If *h* is a matrix, then each column is a separate FIR impulse response sequence. If *yout* is a row or column vector, then it represents one signal. If *yout* is a matrix, then each column is a separate output. No upsampling or downsampling is implemented with this syntax.

`yout = upfirdn(xin,h,p)` specifies the integer upsampling factor `p`, where `p` has a default value of 1.

`yout = upfirdn(xin,h,p,q)` specifies the integer downsampling factor `q`, where `q` has a default value of 1. The length of the output, `yout`, is `ceil(((length(xin) - 1) * p + length(h)) / q)`

Note Since `upfirdn` performs convolution and rate changing, the `yout` signals have a different length than `xin`. The number of rows of `yout` is approximately `p/q` times the number of rows of `xin`.

Examples

Convert from DAT Rate to CD Sampling Rate

Change the sampling rate of a 1 kHz sinusoid by a factor of 147/160. This factor is used to convert from 48 kHz (DAT rate) to 44.1 kHz (CD sampling rate).

```
Fs = 48e3; % Original sampling frequency-48kHz
L = 147; % Interpolation/decimation factors
M = 160;
N = 24*L;
h = fir1(N-1,1/M,kaiser(N,7.8562));
h = L*h; % Passband gain is L

n = 0:10239; % 10240 samples, 0.213 seconds long
x = sin(2*pi*1e3/Fs*n); % Original signal
y = upfirdn(x,h,L,M); % 9430 samples, still 0.213 seconds
```

Plot the first millisecond of the original signal and overlay the resampled version.

```
stem(n(1:49)/Fs,x(1:49))
hold on
stem(n(2:45)/(Fs*L/M),y(13:56),'*')
hold off
xlabel('Time (s)')
ylabel('Signal')
legend('Original','Resampled')
```

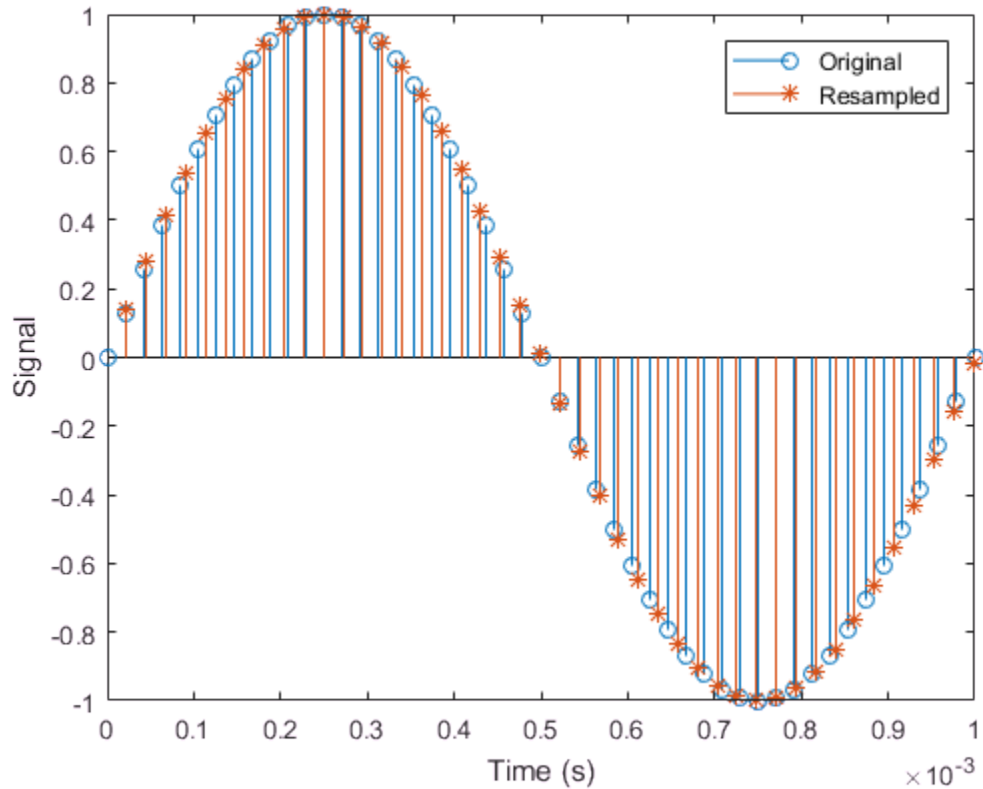

Diagnostics

If p and q are large and do not have many common factors, you may see this message:

Filter length is too large - reduce problem complexity.

Instead, you should use an interpolation function, such as `interp1`, to perform the resampling and then filter the input.

Tips

Usually the inputs `xin` and the filter `h` are vectors, in which case only one output signal is produced. However, when these arguments are arrays, each column is treated as a separate signal or filter. Valid combinations are:

- 1 `xin` is a vector and `h` is a vector.

There is one filter and one signal, so the function convolves `xin` with `h`. The output signal `yout` is a row vector if `xin` is a row; otherwise, `yout` is a column vector.

- 2 `xin` is a matrix and `h` is a vector.

There is one filter and many signals, so the function convolves `h` with each column of `xin`. The resulting `yout` will be an matrix with the same number of columns as `xin`.

- 3 `xin` is a vector and `h` is a matrix.

There are many filters and one signal, so the function convolves each column of `h` with `xin`. The resulting `yout` will be an matrix with the same number of columns as `h`.

- 4 `xin` is a matrix and `h` is a matrix, both with the same number of columns.

There are many filters and many signals, so the function convolves corresponding columns of `xin` and `h`. The resulting `yout` is an matrix with the same number of columns as `xin` and `h`.

Algorithms

`upfirdn` uses a polyphase interpolation structure. The number of multiply-add operations in the polyphase structure is approximately $(L_h L_x - p L_x)/q$ where L_h and L_x are the lengths of $h(n)$ and $x(n)$, respectively.

A more accurate flops count is computed in the program, but the actual count is still approximate. For long signals $x(n)$, the formula is often exact.

References

- [1] Crochiere, R. E., and Lawrence R. Rabiner. *Multirate Digital Signal Processing*. Englewood Cliffs, NJ: Prentice-Hall, 1983, pp.88–91.

- [2] Crochiere, R. E. “A General Program to Perform Sampling Rate Conversion of Data by Rational Ratios.” *Programs for Digital Signal Processing* (Digital Signal Processing Committee of the IEEE Acoustics, Speech, and Signal Processing Society, eds.). New York: IEEE Press, 1979, Programs 8.2-1–8.2-7.

Extended Capabilities

C/C++ Code Generation

Generate C and C++ code using MATLAB® Coder™.

Usage notes and limitations:

C and C++ code generation for `upfirdn` requires DSP System Toolbox software.

Filter coefficients, upsampling factor, and downsampling factor must be constants. Expressions or variables are allowed if their values do not change.

Variable-size inputs are not supported.

See Also

`conv` | `decimate` | `filter` | `interp` | `downsample` | `intfilt` | `resample` | `upsample`

Introduced before R2006a

upsample

Increase sampling rate by integer factor

Syntax

```
y = upsample(x,n)
y = upsample(x,n,phase)
```

Description

`y = upsample(x,n)` increases the sampling rate of `x` by inserting $n - 1$ zeros between samples. `x` can be a vector or a matrix. If `x` is a matrix, each column is considered a separate sequence. The upsampled `y` has $x*n$ samples.

`y = upsample(x,n,phase)` specifies the number of samples by which to offset the upsampled sequence. `phase` must be an integer from 0 to $n - 1$.

Examples

Increase Sampling Rates

Increase the sampling rate of a sequence by 3.

```
x = [1 2 3 4];
y = upsample(x,3)
```

```
y =
```

```
1 0 0 2 0 0 3 0 0 4 0 0
```

Increase the sampling rate of the sequence by 3 and add a phase offset of 2.

```
x = [1 2 3 4];
y = upsample(x,3,2)
```

```
y =
```

```
0 0 1 0 0 2 0 0 3 0 0 4
```

Increase the sampling rate of a matrix by 3.

```
x = [1 2;
     3 4;
     5 6];
y = upsample(x,3)
```

```
y =
     1     2
     0     0
     0     0
     3     4
     0     0
     0     0
     5     6
     0     0
     0     0
```

Extended Capabilities

C/C++ Code Generation

Generate C and C++ code using MATLAB® Coder™.

Usage notes and limitations:

Either declare input `n` as constant, or use the `assert` function in the calling function to set upper bounds for `n`. For example,

```
assert(n<10)
```

See Also

`decimate` | `interp` | `downsample` | `interp1` | `resample` | `spline` | `upfirdn`

Introduced before R2006a

undershoot

Undershoot metrics of bilevel waveform transitions

Syntax

```

US = undershoot(X)
US = undershoot(X,FS)
US = undershoot(X,T)
[US,USLEV,USINST] = undershoot(...)
[...] = undershoot(...,Name,Value)
undershoot(...)

```

Description

`US = undershoot(X)` returns the greatest deviations below the final state levels of each transition in the bilevel waveform, `X`. The undershoots, `US`, are expressed as a percentage of the difference between the state levels. See “Undershoot” on page 1-2466. The length of `US` corresponds to the number of transitions detected in the input signal. The sample instants in `X` correspond to the vector indices. To determine the transitions, `undershoot` estimates the state levels of the input waveform by a histogram method. `undershoot` identifies all regions that cross the upper-state boundary of the low state and the lower-state boundary of the high state. The low-state and high-state boundaries are expressed as the state level plus or minus a multiple of the difference between the state levels. See “State-Level Tolerances” on page 1-2467.

`US = undershoot(X,FS)` specifies the sampling frequency, `FS`, in hertz. The sampling frequency determines the sample instants corresponding to the elements in `X`. The first sample instant in `X` corresponds to $t=0$.

`US = undershoot(X,T)` specifies the sample instants, `T`, as a vector with the same number of elements as `X`.

`[US,USLEV,USINST] = undershoot(...)` returns the levels, `USLEV`, and sample instants, `USINST`, of the undershoots for each transition.

`[...] = undershoot(...,Name,Value)` returns the greatest deviations below the final state level with additional options specified by one or more `Name, Value` pair arguments.

`undershoot (. . .)` plots the bilevel waveform and marks the location of the undershoot of each transition as well as the lower- and upper reference-level instants and the associated reference levels. `undershoot` also plots the state levels and associated lower- and upper-state boundaries.

Input Arguments

X

Bilevel waveform. `X` is a real-valued row or column vector.

FS

Sample rate in hertz.

T

Vector of sample instants. The length of `T` must equal the length of the bilevel waveform, `X`.

Name-Value Pair Arguments

'PercentReferenceLevels'

Reference levels as a percentage of the waveform amplitude. The lower-state level is defined to be 0 percent. The upper-state level is defined to be 100 percent. The value of `'PercentReferenceLevels'` is a 2-element real row vector whose elements correspond to the lower and upper percent reference levels.

Default: [10 90]

'Region'

Specify the region over which to perform the undershoot computation. Valid values for `'Region'` are `'Preshoot'` or `'Postshoot'`. If you specify `'Preshoot'`, the end of the pretransition aberration region is defined as the last instant when the signal exits the first state. If you specify `'Postshoot'`, the start of the posttransition aberration region is defined as the instant when the signal enters the second state.

Default: 'Postshoot'

'SeekFactor'

Aberration region duration. Specifies the duration of the region over which to compute the undershoot for each transition as a multiple of the corresponding transition duration. The edge of the waveform may be reached, or a complete intervening transition may be detected, before the duration aberration region duration elapses. In such cases, the duration is truncated to the edge of the waveform or the start of the intervening transition.

Default: 3

'StateLevels'

Lower- and upper-state levels. Specify the levels to use for the lower- and upper-state levels as a 2-element real row vector whose first and second elements correspond to the lower- and upper-state levels of the input waveform.

'Tolerance'

Specify the tolerance that the initial and final levels of each transition must be within the respective state levels. The 'Tolerance' value is a scalar expressing a percentage of the difference between the upper- and lower-state levels. See “State-Level Tolerances” on page 1-2467.

Default: 2

Output Arguments

US

Undershoots expressed as a percentage of the state levels. The undershoot percentages are computed based on the greatest deviation from the final state level in each transition. By default undershoots are computed for posttransition aberration regions. See “Undershoot” on page 1-2466.

USLEV

Level of the pretransition or posttransition undershoot.

USINST

Sample instants of pretransition or posttransition undershoots. If you specify the sampling frequency or sampling instants, the undershoot instants are in seconds. If you do not specify the sampling frequency or sampling instants, the undershoot instants are the indices of the input vector.

Examples

Undershoot Percentage in Posttransition Aberration Region

Determine the maximum percent undershoot relative to the high-state level in a 2.3 V clock waveform.

Load the 2.3 V clock data. Determine the maximum percent undershoot of the transition. Determine also the level and sample instant of the undershoot. In this example, the maximum undershoot in the posttransition region occurs near index 23.

```
load('transitionex.mat','x')
```

```
[uu,lv,nst] = undershoot(x)
```

```
uu = 4.5012
```

```
lv = 2.1826
```

```
nst = 23
```

Plot the waveform. Annotate the overshoot and the corresponding sample instant.

```
undershoot(x);
```

```
ax = gca;
```

```
ax.XTick = sort([ax.XTick nst]);
```

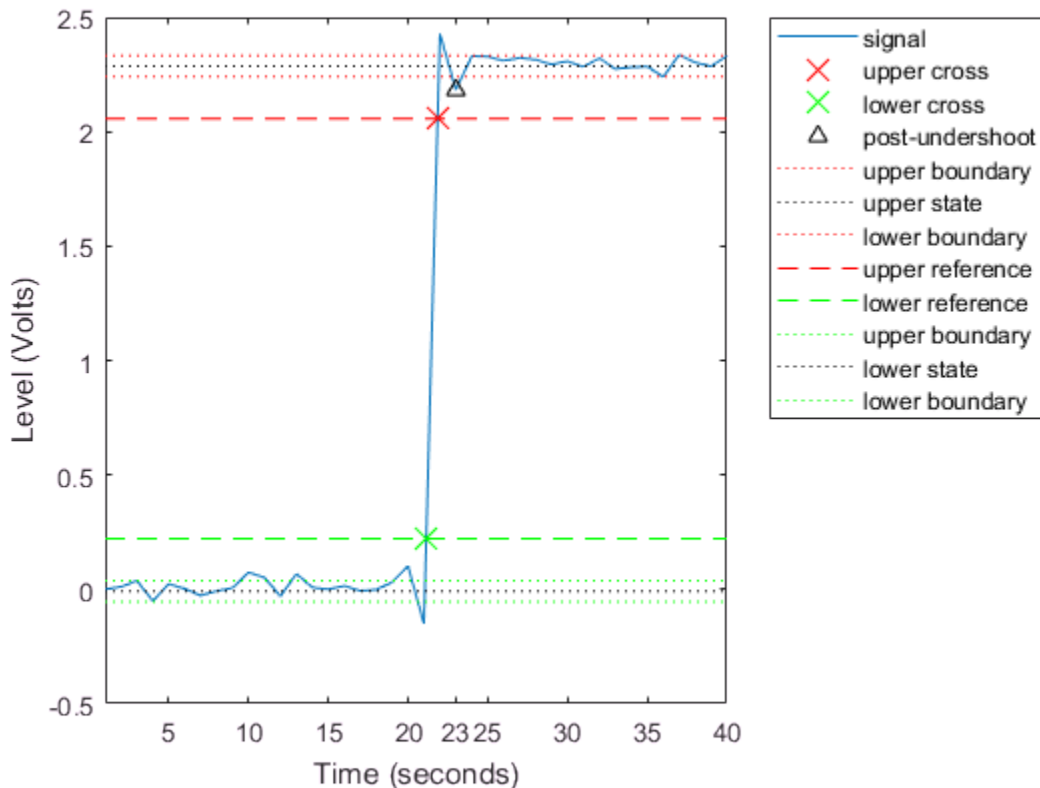

Undershoot Percentage, Levels, and Time Instant in Posttransition Aberration Region

Determine the maximum percent undershoot relative to the high-state level, the level of the undershoot, and the sample instant in a 2.3 V clock waveform.

Load the 2.3 V clock data with sampling instants. The clock data are sampled at 4 MHz.

```
load('transition.mat','x','t')
```

Determine the maximum percent undershoot, the level of the undershoot in volts, and the time instant where the maximum undershoot occurs. Plot the result.

```
[us,uslev,usinst] = undershoot(x,t)
```

```

us = 4.5012
uslev = 2.1826
usinst = 5.5000e-06

undershoot(x,t);

```

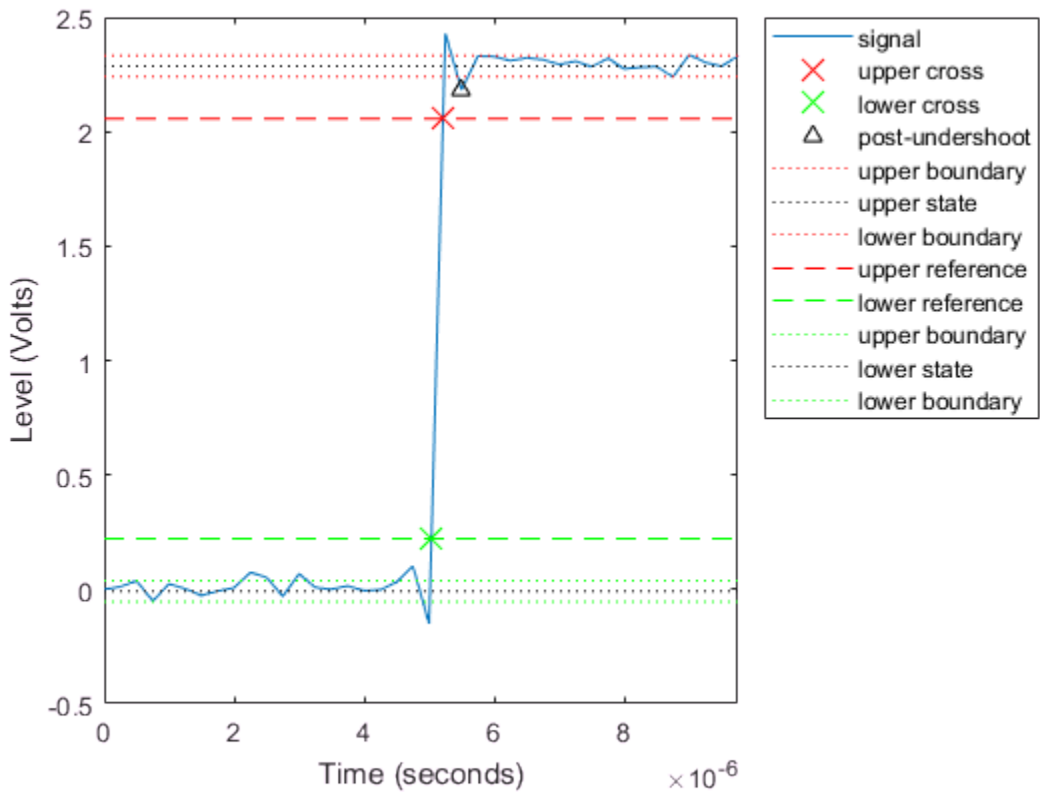

Undershoot Percentage, Levels, and Time Instant in Pretransition Aberration Region

Determine the maximum percent undershoot relative to the low-state level, the level of the undershoot, and the sample instant in a 2.3 V clock waveform. Specify the 'Region' as 'Preshoot' to output pretransition metrics.

Load the 2.3 V clock data with sampling instants. The clock data are sampled at 4 MHz.

```
load('transitionex.mat','x','t')
```

Determine the maximum percent undershoot, the level of the undershoot in volts, and the sampling instant where the maximum undershoot occurs. Plot the result.

```
[us,uslev,usinst] = undershoot(x,t,'Region','Preshoot')
```

```
us = 6.1798
```

```
uslev = -0.1500
```

```
usinst = 5.0000e-06
```

```
undershoot(x,t,'Region','Preshoot');
```

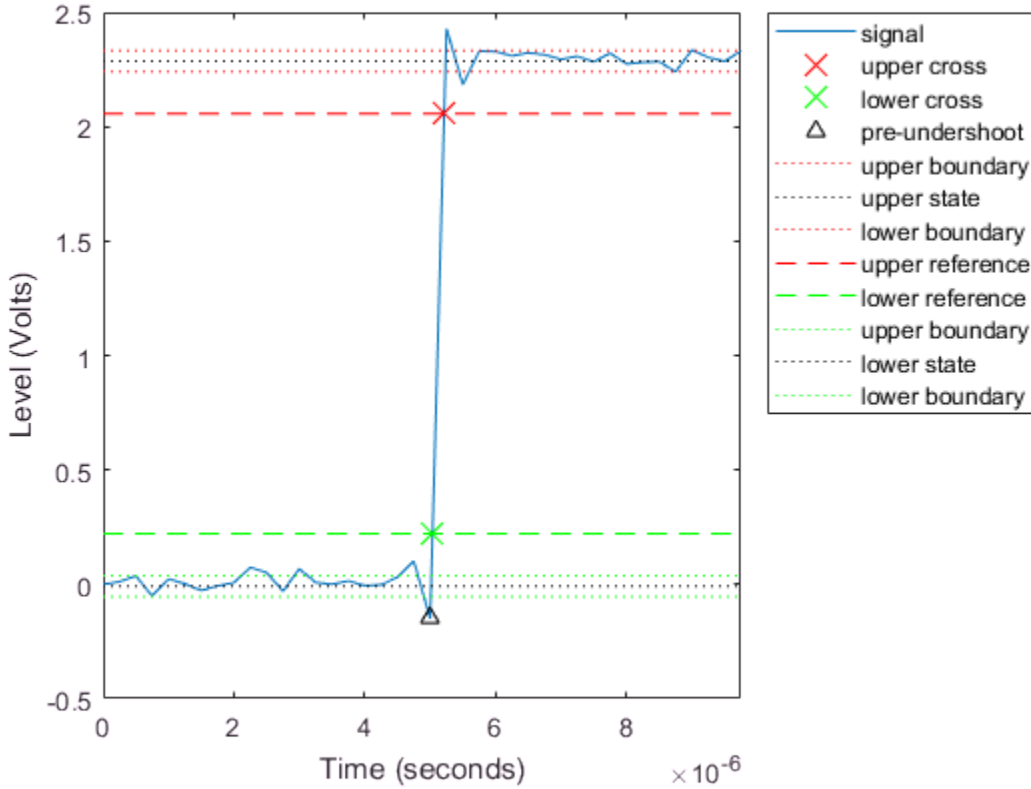

Definitions

Undershoot

For a positive-going (positive-polarity) pulse, undershoot expressed as a percentage is

$$100 \frac{(S_2 - U)}{(S_2 - S_1)}$$

where U is the greatest deviation below the high-state level, S_2 is the high state, and S_1 is the low state.

For a negative-going (negative-polarity) pulse, undershoot expressed as a percentage is

$$100 \frac{(S_1 - U)}{(S_2 - S_1)}$$

The following figure illustrates the calculation of undershoot for a positive-going transition.

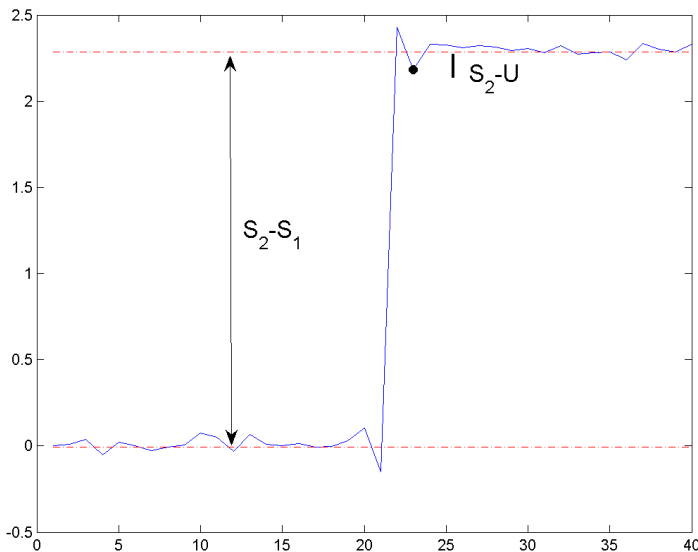

The red dashed lines indicate the estimated state levels. The double-sided black arrow depicts the difference between the high- and low-state levels. The solid black line indicates the difference between the high-state level and the undershoot value.

State-Level Tolerances

Each state level can have associated lower- and upper-state boundaries. These state boundaries are defined as the state level plus or minus a scalar multiple of the difference

between the high state and the low state. To provide a useful tolerance region, the scalar is typically a small number such as 2/100 or 3/100. In general, the $\alpha\%$ region for the low state is defined as

$$S_1 \pm \frac{\alpha}{100}(S_2 - S_1),$$

where S_1 is the low-state level and S_2 is the high-state level. Replace the first term in the equation with S_2 to obtain the $\alpha\%$ tolerance region for the high state.

The following figure illustrates lower and upper 2% state boundaries (tolerance regions) for a positive-polarity bilevel waveform. The red dashed lines indicate the estimated state levels.

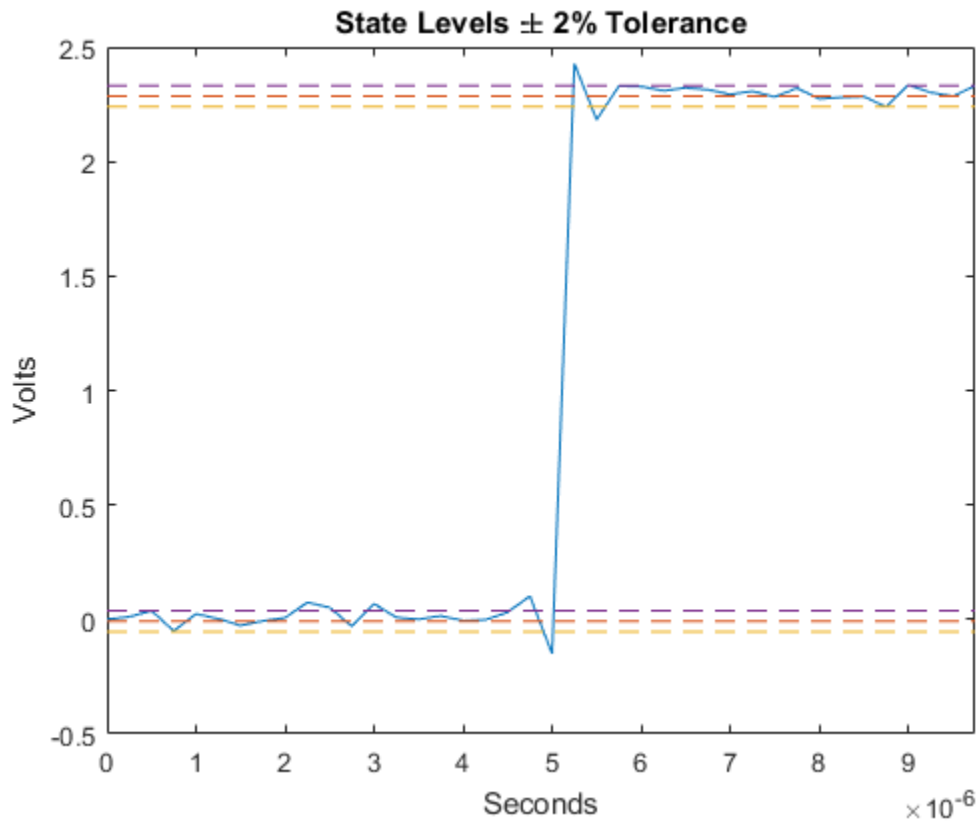

References

- [1] *IEEE Standard on Transitions, Pulses, and Related Waveforms*, IEEE Standard 181, 2003, pp. 15–17.

See Also

See Also

overshoot | settlingtime | statelevels

Introduced in R2012a

validstructures

Structures for specification object with design method

Syntax

```
filtstruct = validstructures(D, 'Systemobject', true)
filtstruct = validstructures(D, METHOD, 'Systemobject', true)
```

Description

`filtstruct = validstructures(D, 'Systemobject', true)` returns a structure of cell arrays, `filtstruct`, which contains a set of valid filter structures for the filter specification object, `D`. When you set `'Systemobject'` to `true`, `validstructures` returns a list of structures that support filter System objects. Each field in `filtstruct` lists a set of filter structures for the design method specified.

`filtstruct = validstructures(D, METHOD, 'Systemobject', true)` returns the valid structures for the filter specification object, `D`, and the design method, `METHOD`, in a cell array of character vectors.

Examples

Valid Filter Structures

Design a default lowpass filter specification object. Return all valid design methods and structures in a structure array. Display the fieldnames to see all valid design methods. Display the valid filter structures for the `equiripple` field.

```
D = fdesign.lowpass;
filtstruct = validstructures(D);

fn = fieldnames(filtstruct)

fn = 8×1 cell array
    'butter'
    'cheby1'
```

```
'cheby2'  
'ellip'  
'equiripple'  
'ifir'  
'multistage'  
'kaiserwin'
```

```
strs = eval(['filtstruct.' fn{5}])  
  
strs = 1×4 cell array  
    'dffir'    'dffirt'    'dfsymfir'    'fftfir'
```

Create a highpass filter of order 50 with a 3-dB frequency of 0.2. Obtain the available structures for a Butterworth design.

```
D = fdesign.highpass('N,F3dB',50,0.2);  
C = validstructures(D,'butter')  
  
C = 1×6 cell array  
    'df1sos'    'df2sos'    'df1tsos'    'df2tsos'    'cascadeallpass'    'cascadewdfa'
```

See Also

See Also

[design](#) | [designmethods](#) | [designopts](#) | [fdesign](#)

Introduced in R2009a

vco

Voltage controlled oscillator

Syntax

```
y = vco(x,fc,fs)
y = vco(x,[Fmin Fmax],fs)
```

Description

`y = vco(x,fc,fs)` creates a signal that oscillates at a frequency determined by the real input vector or array `x` with sampling frequency `fs`. `fc` is the carrier or reference frequency; when `x` is 0, `y` is an `fc` Hz cosine with amplitude 1 sampled at `fs` Hz. `x` ranges from -1 to 1, where `x = -1` corresponds to 0 frequency output, `x = 0` corresponds to `fc`, and `x = 1` corresponds to `2*fc`. Output `y` is the same size as `x`.

`y = vco(x,[Fmin Fmax],fs)` scales the frequency modulation range so that ± 1 values of `x` yield oscillations of `Fmin` Hz and `Fmax` Hz respectively. For best results, `Fmin` and `Fmax` should be in the range 0 to `fs/2`.

By default, `fs` is 1 and `fc` is `fs/4`.

If `x` is a matrix, `vco` produces a matrix whose columns oscillate according to the columns of `x`.

Examples

Spectrogram of Sawtooth Signal

Generate two seconds of a signal sampled at 10 kHz whose instantaneous frequency is a triangle function of time.

```
fs = 10000;
t = 0:1/fs:2;
x = vco(sawtooth(2*pi*t,0.75),[0.1 0.4]*fs,fs);
```

Plot the spectrogram of the generated signal.

```
spectrogram(x,kaiser(256,5),220,512,fs,'yaxis')
```

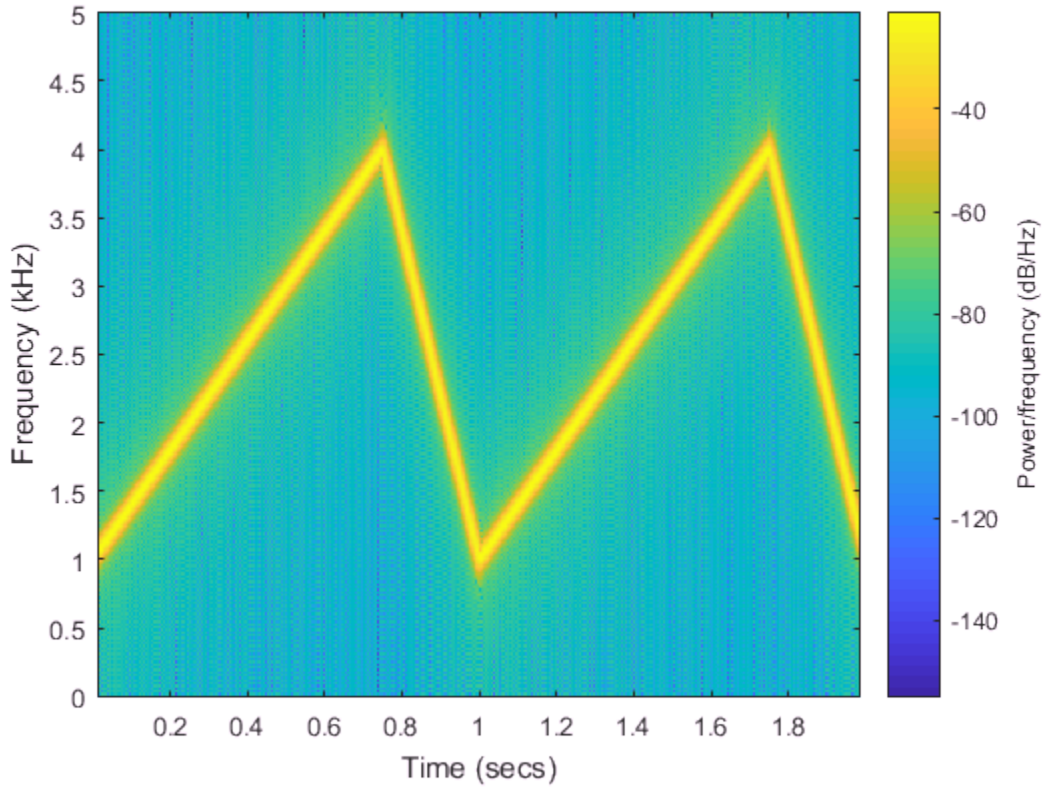

Diagnostics

If any values of x lie outside $[-1, 1]$, `vco` gives the following error message:

```
X outside of range [-1,1].
```

Algorithms

`vco` performs FM modulation using the `modulate` function.

See Also

demod | modulate

Introduced before R2006a

window

Window function gateway

Syntax

```
window  
w = window(fhandle,n)  
w = window(fhandle,n,winopt)
```

Description

window opens the Window Designer app.

`w = window(fhandle,n)` returns the *n*-point window, specified by its function handle, `fhandle`, in column vector `w`. Function handles are window function names preceded by an `@`.

```
@barthannwin  
@bartlett  
@blackman  
@blackmanharris  
@bohmanwin  
@chebwin  
@flattopwin  
@gausswin  
@hamming  
@hann  
@kaiser  
@nuttallwin  
@parzenwin  
@rectwin  
@taylorwin  
@triang  
@tukeywin
```

Note For `chebwin`, `kaiser`, and `tukeywin`, you must use include a window parameter using the syntax below.

For more information on each window function and its option(s), refer to its reference page.

`w = window(fhandle, n, winopt)` returns the window specified by its function handle, `fhandle`, and its `winopt` value or sampling descriptor. For `chebwin`, `kaiser`, and `tukeywin`, you must enter a `winopt` value. For the other windows listed below, `winopt` values are optional.

Window	winopt Description	winopt Value
<code>blackman</code>	window sampling	'periodic' or 'symmetric'
<code>chebwin</code>	sidelobe attenuation relative to mainlobe	numeric
<code>flattopwin</code>	window sampling	'periodic' or 'symmetric'
<code>gausswin</code>	alpha value (reciprocal of standard deviation)	numeric
<code>hamming</code>	window sampling	'periodic' or 'symmetric'
<code>hann</code>	window sampling	'periodic' or 'symmetric'
<code>kaiser</code>	beta value	numeric
<code>taylorwin</code>	1. number of sidelobes 2. maximum sidelobe level in dB relative to mainlobe peak	1. integer greater than or equal to 1 2. negative value
<code>tukeywin</code>	ratio of taper to constant sections	numeric

Examples

Blackman-Harris, Hamming, and Gaussian Windows

Create Blackman Harris, Hamming, and Gaussian windows and plot them in the same WVTool.

```
N = 65;
w = window(@blackmanharris,N);
w1 = window(@hamming,N);
w2 = window(@gausswin,N,2.5);
wvtool(w,w1,w2)
```

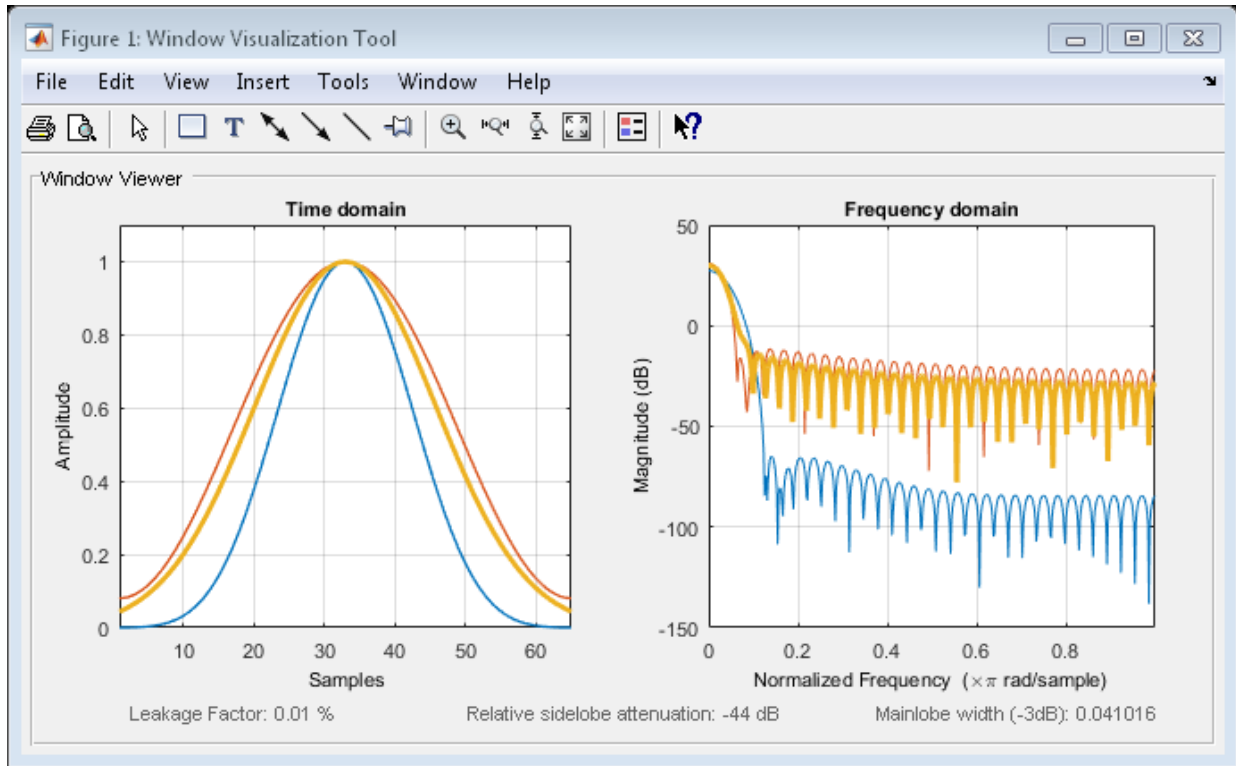

See Also

barthannwin | bartlett | blackman | blackmanharris | bohmanwin | chebwin | flattopwin | gausswin | hamming | hann | kaiser | nuttallwin | parzenwin | rectwin | triang | taylorwin | tukeywin

Introduced before R2006a

window (filter design method)

FIR filter using windowed impulse response

Syntax

```
h = window(d, 'window', fcnhdl)  
h = window(d, win)
```

Description

Note: This is a description of the overloaded method used in conjunction with `fdesign` to design a filter from a filter specification object. To access the window function gateway see `window`.

`h = window(d, 'window', fcnhdl)` designs an FIR filter using the specifications in filter specification object `d`.

`fcnhdl` is a handle to a filter design function that returns a window vector, such as the `hamming` or `blackman` functions. `fcnarg` is an optional argument that returns a window. You pass the function to `window`. Refer to example 1 in the following section to see the function argument used to design the filter.

`h = window(d, win)` designs a filter using the vector you supply in `win`. The length of vector `win` must be the same as the impulse response of the filter, which is equal to the filter order plus one.

Examples

Lowpass Filter Window Design

Construct a lowpass filter specification object of order 10 with a cutoff frequency of 12 kHz. Use a sample rate of 48 kHz. Use a function handle to the `kaiser` function to provide the window.

```
d = fdesign.lowpass('n,fc',10,12000,48000);  
Hd = window(d,'window',@kaiser);  
fvtool(Hd)
```

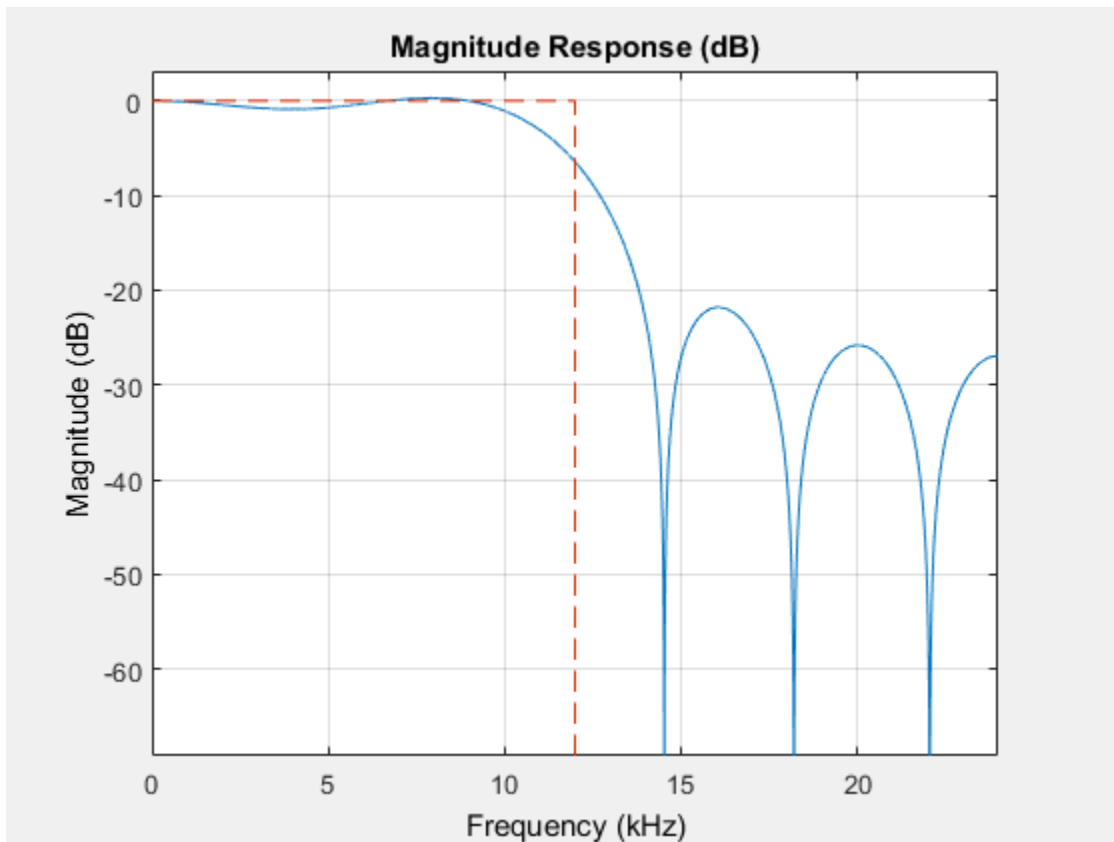

See Also

See Also

Apps

Filter Designer

Functions

`designfilt` | `fdesign` | `filt2block`

Introduced in R2009a

Window Designer

Design and analyze spectral windows

Description

The **Window Designer** app enables you to design and analyze spectral windows. Using this app, you can:

- Display the time-domain and frequency-domain representations of one or more windows.
- Study how the behavior of a window changes as a function of its length and other parameters.
- Design windows graphically and export them to the MATLAB workspace.

Open the Window Designer App

- MATLAB Toolstrip: On the **Apps** tab, under **Signal Processing and Communications**, click the app icon.
- MATLAB command prompt: Enter `windowDesigner`.

Examples

Bohman Window

Use **Window Designer** to specify a Bohman window of length 128 and export it to the workspace.

- 1 Create a Bohman window.
 - From the **Type** list, select Bohman.
 - Under **Length**, enter 128.
 - Under **Name**, enter `bohwin`.
- 2 Click **Apply**. The **Window Viewer** box shows the window in the time and frequency domains.

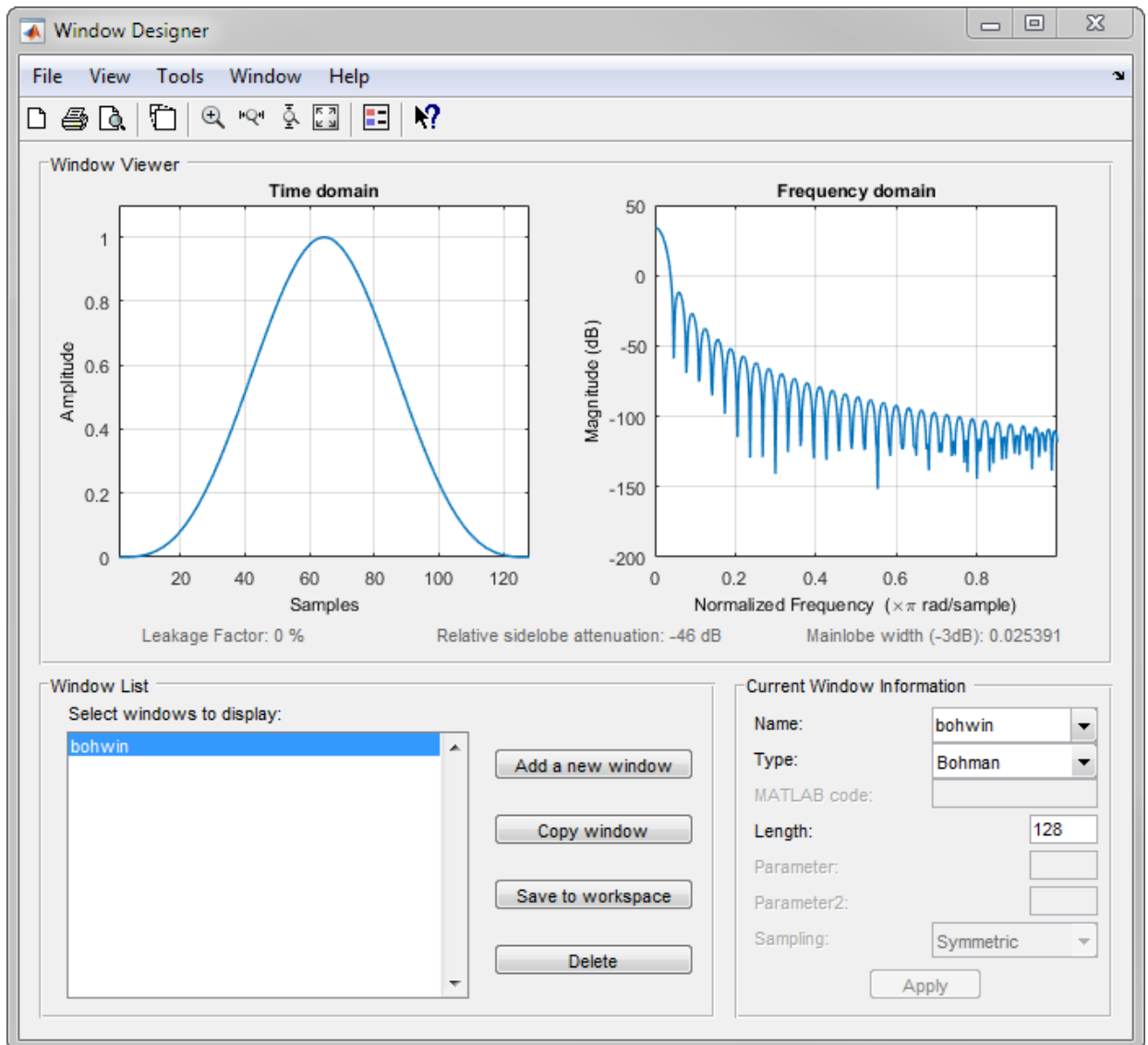

3 Click **Save to workspace**. In the command line, you see this message:

bohwin has been exported to the workspace.

- 4 Verify that the new window is present in the workspace.

```
whos bohwin
```

Name	Size	Bytes	Class	Attributes
bohwin	128x1	1024	double	

Kaiser Windows

Use **Window Designer** to see how the behavior of a Kaiser window depends on the window length and the shape parameter, β .

- 1 Create a Kaiser window.
 - From the **Type** list, select **Kaiser**.
 - Under **Length**, enter 20.
 - Under **Beta**, enter 0.
 - Under **Name**, enter `kaiser0`.
- 2 Click **Apply**. The **Window Viewer** box shows the window in the time and frequency domains.
- 3 Click **Add a new window**. Create a Kaiser window of length 20 with **Beta** equal to 3. Name the window `kaiser3` and click **Apply**.
- 4 Click **Copy window** to create a third Kaiser window, `kaiser6`, with **Beta** equal to 6. Click **Apply**.
- 5 Under **Window List** select the three windows.

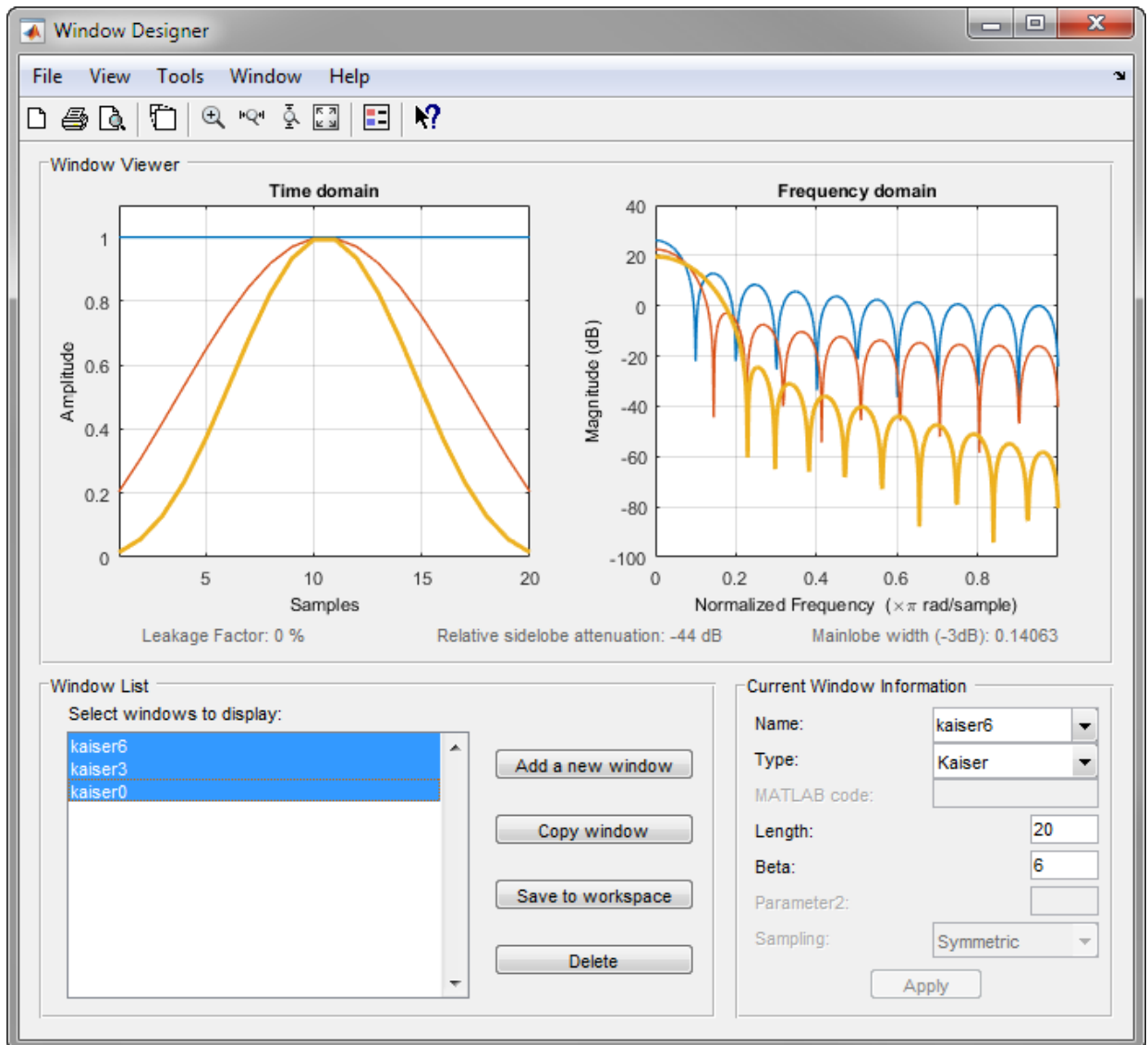

- 6 Select **kaiser0** from the **Name** list to emphasize it in the **Window Viewer** plots. Set **Length** to 10 and **Beta** to 6. Click **Apply**.

- 7 Select **kaiser3** from the **Name** list. Leave **Length** set to 20 and set **Beta** to 6. Click **Apply**.
- 8 Select **kaiser6** from the **Name** list. Leave **Beta** set to 6 and set **Length** to 40. Click **Apply**.
- 9 Select **kaiser3** from the **Name** list. Click the **Turn Legend On** button .

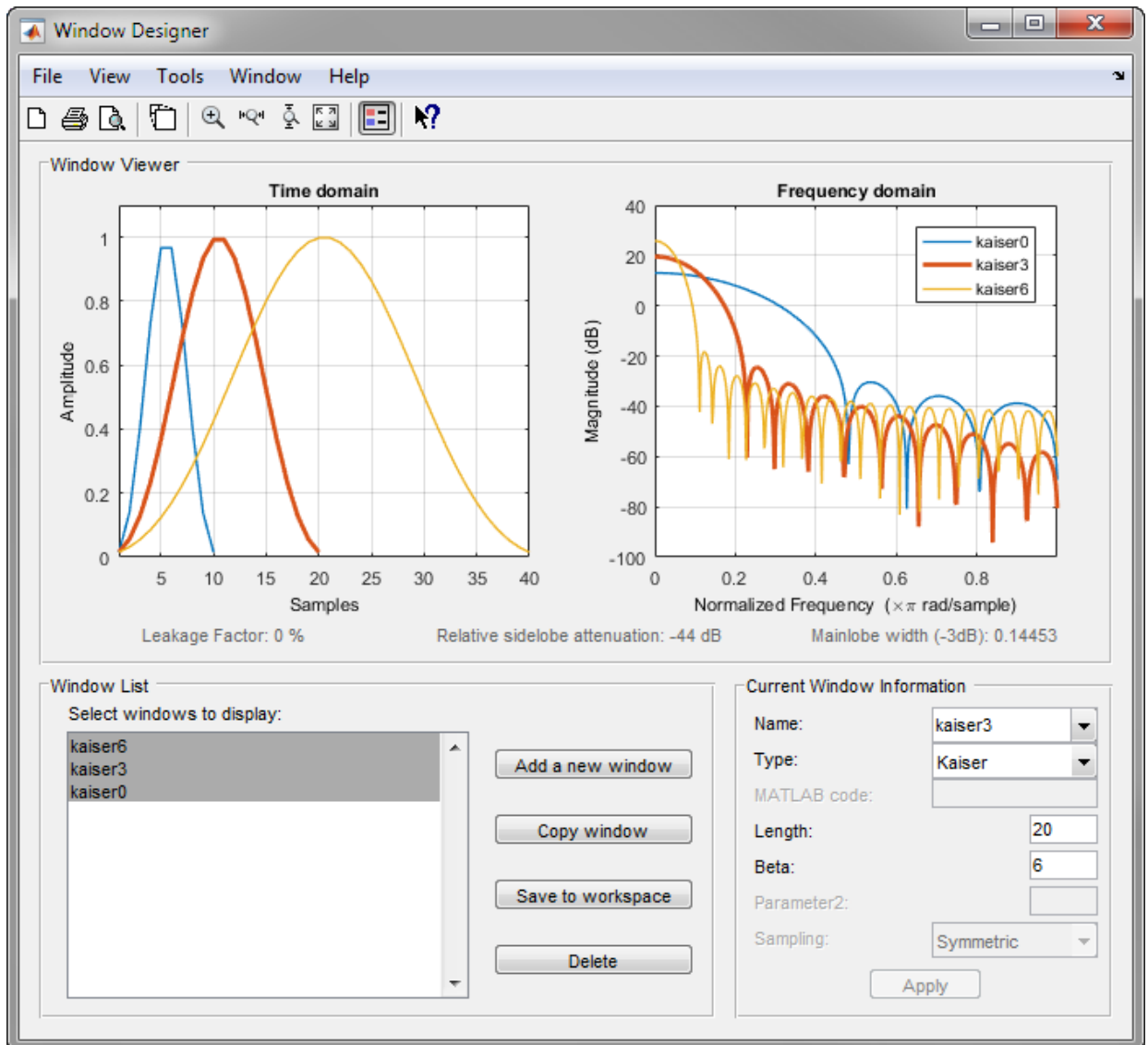

Hamming Window Sidelobes

Use **Window Designer** to visualize the sidelobes of the default 64-sample Hamming window.

- 1 In the **View** menu, clear **Time domain** and click **Analysis Parameters**.
- 2 In the dialog box, specify these parameters:
 - Under **Number of points**, enter 8192.
 - Set **Frequency Units** to Hz.
 -
 - Set **Sampling Frequency** to 500 Hz
 - Select **Normalize Magnitude**.

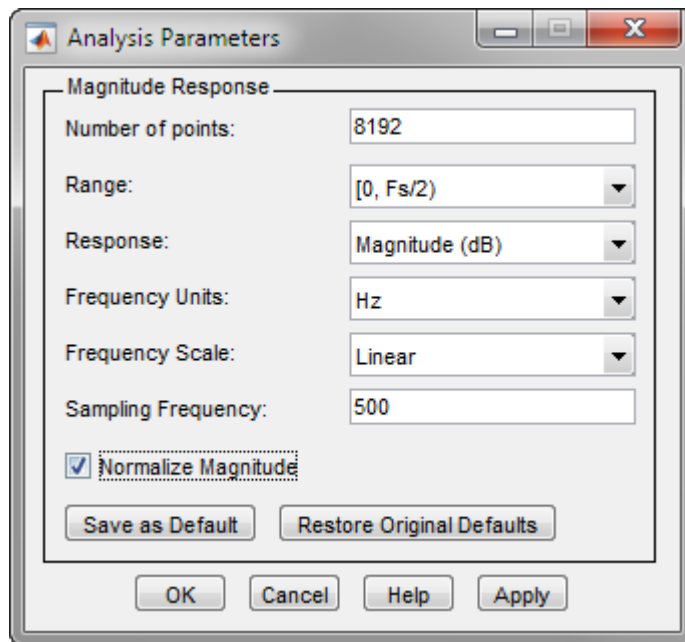

- 3 Click **OK** to close the dialog box. Click the **Zoom X-Axis** button . Zoom into the region between 10 Hz and 35 Hz to view the window's first two sidelobes in detail.

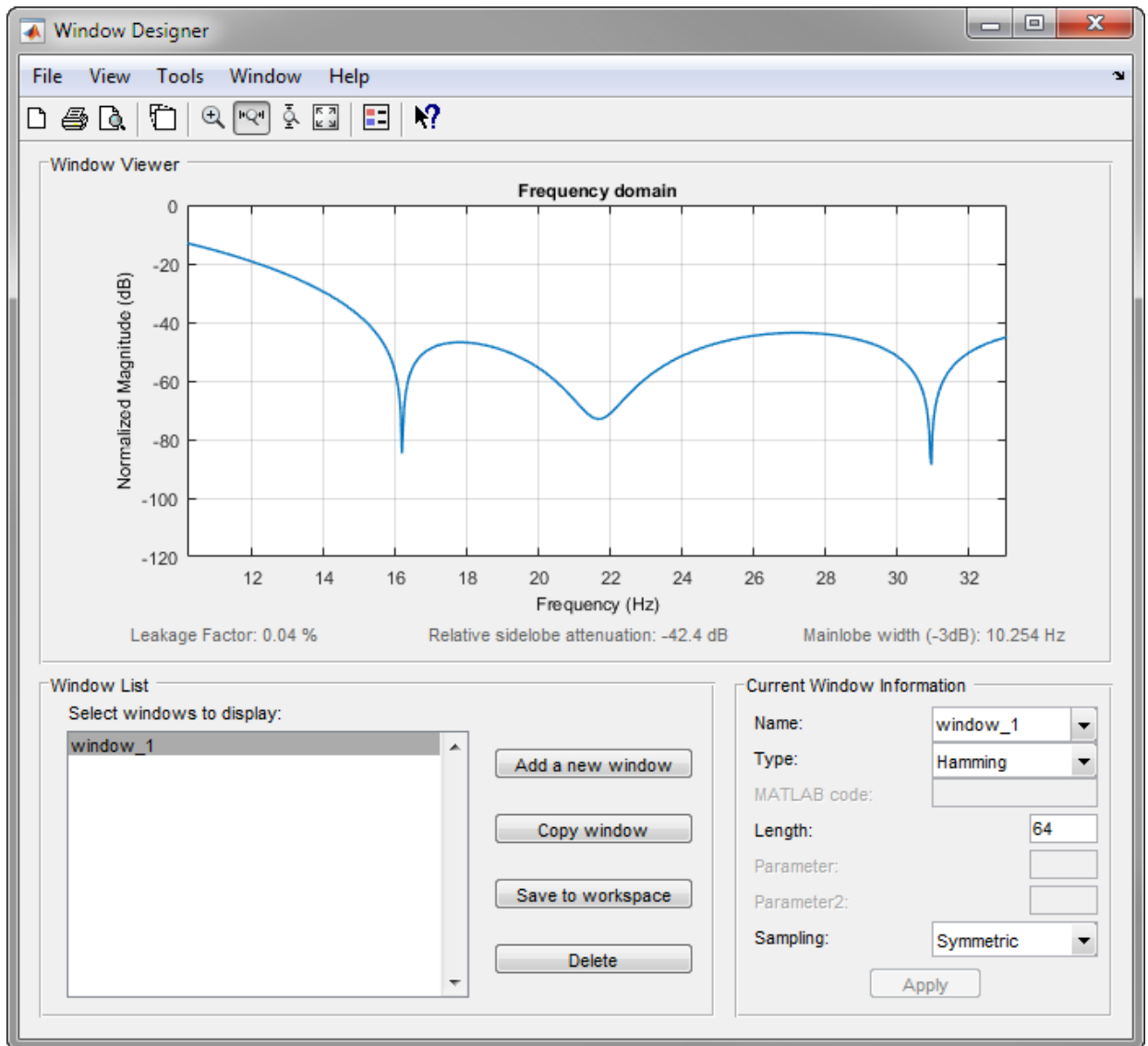

- “Windows”
- “Generalized Cosine Windows”

- “Kaiser Window”
- “Chebyshev Window”

See Also

See Also

Apps

Filter Designer | Signal Analyzer

Functions

window | wvtool

Topics

“Windows”

“Generalized Cosine Windows”

“Kaiser Window”

“Chebyshev Window”

Introduced before R2006a

wvtool

Open Window Visualization Tool

Syntax

```
wvtool(WindowVector)
wvtool(WindowVector1,...,WindowVectorN)
H = wvtool(...)
```

Description

`wvtool(WindowVector)` opens the Window Visualization Tool (WVTool) with time and frequency domain plots of the window vector specified in `WindowVector`. `WindowVector` must be a real-valued row or column vector. By default, the frequency domain plot is the magnitude squared of the Fourier transform of the window vector in decibels (dB). You can generate window vectors for a number of common window functions using the Signal Processing Toolbox software. See `window` for a list of supported window functions.

`wvtool(WindowVector1,...,WindowVectorN)` opens WVTool with time and frequency domain plots of the window vectors specified in `WindowVector1`, ..., `WindowVectorN`.

`H = wvtool(...)` returns the figure handle, `H`.

Note A related tool, Window Designer, is available for designing and analyzing windows.

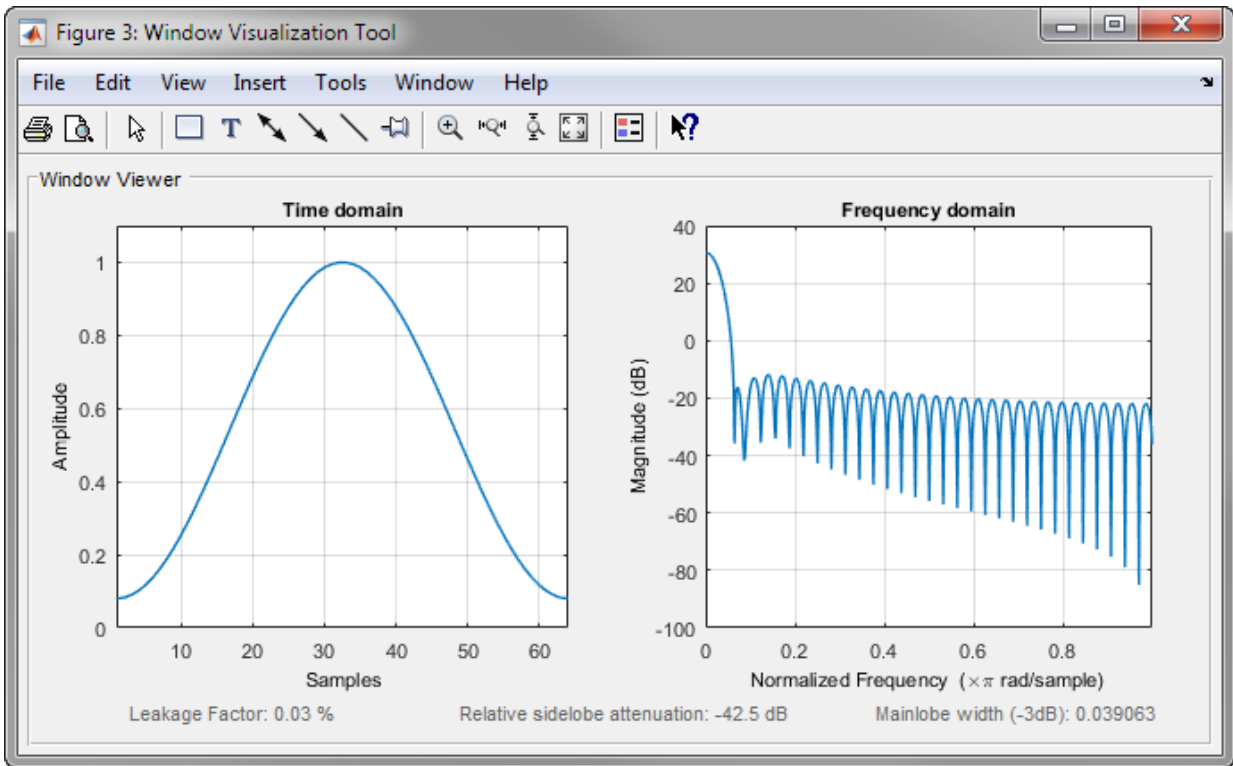

Note If you launch WVTool from Filter Designer, an **Add/Replace** icon, which controls how new windows are added from Filter Designer, appears on the toolbar.

WVTool Menus

In addition to the usual menus items, `wvtool` contains these `wvtool`-specific menu commands:

File menu:

- **Export** — Exports the displayed plot(s) to a graphic file.

Edit menu:

- **Copy figure** — Copies the displayed plot(s) to the clipboard (available only on Windows platforms).
- **Copy options** — Displays the Preferences dialog box (available only on Windows platforms).
- **Figure, Axes, and Current Object Properties** — Displays the Property Editor.

View menu:

- **Time domain** — Check to show the time domain plot.
- **Frequency domain** — Check to show the frequency domain plot.
- **Legend** — Toggles the window name legend on and off. This option is also available with the **Legend** toolbar button.
- *Analysis Parameters* — Controls the response plot parameters, including number of points, range, x - and y -axis units, sampling frequency, and normalized magnitude.

You can also access the Analysis Parameters by right-clicking the x -axis label of a plot in the Window Viewer panel.

- **Insert** menu:

You use the **Insert** menu to add labels, titles, arrows, lines, text, and axes to your plots.

Tools menu:

- **Edit Plot** — Turns on plot editing mode
- **Zoom In** — Zooms in along both x - and y -axes.
- **Zoom X** — Zooms in along the x -axis only. Drag the mouse in the x direction to select the zoom area.
- **Zoom Y** — Zooms in along the y -axis only. Drag the mouse in the y direction to select the zoom area.
- **Full View** — Returns to full view.

Examples

Display and Compare Windows

Use `wvtool` to display and compare 64-point Hamming, Hann, and Gaussian windows.

```
wvtool(hamming(64),hann(64),gausswin(64))
```

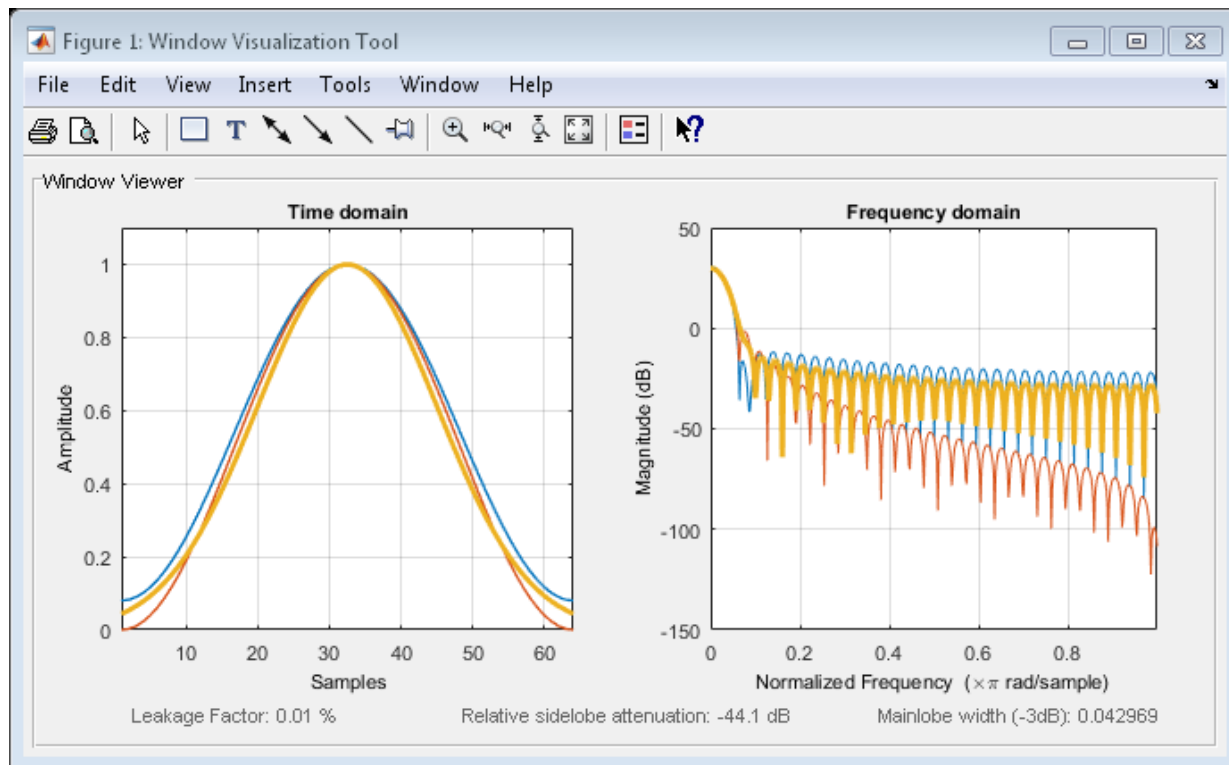

Compare 128-point Kaiser windows with different values of β .

```
wvtool(kaiser(128,1.5),kaiser(128,4.5))
```

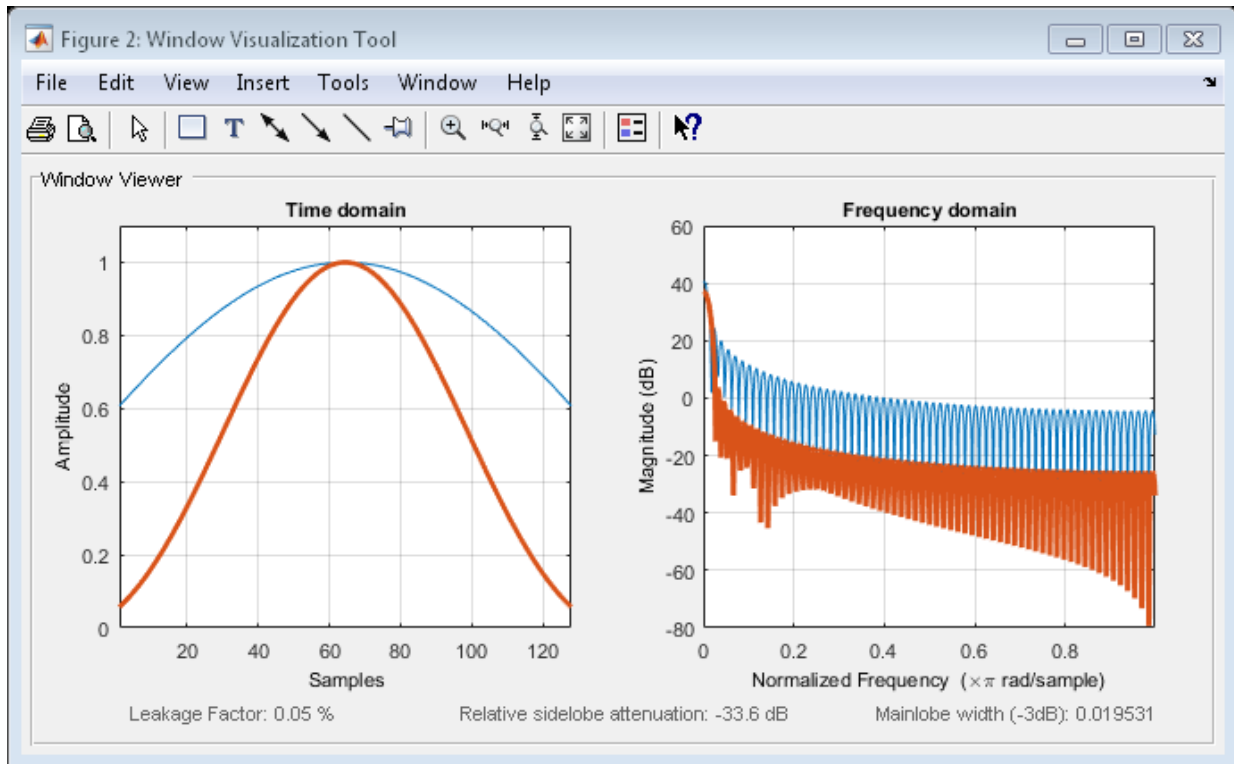

See Also

See Also

Apps

Filter Designer | Window Designer

Functions

window

Introduced before R2006a

xcorr

Cross-correlation

Syntax

```
r = xcorr(x,y)
r = xcorr(x)
```

```
r = xcorr( ____,maxlag)
r = xcorr( ____,scaleopt)
```

```
[r,lags] = xcorr( ____ )
```

Description

`r = xcorr(x,y)` returns the cross-correlation of two discrete-time sequences, `x` and `y`. Cross-correlation measures the similarity between `x` and shifted (lagged) copies of `y` as a function of the lag. If `x` and `y` have different lengths, the function appends zeros at the end of the shorter vector so it has the same length, N , as the other.

`r = xcorr(x)` returns the autocorrelation sequence of `x`. If `x` is a matrix, then `r` is a matrix whose columns contain the autocorrelation and cross-correlation sequences for all combinations of the columns of `x`.

`r = xcorr(____,maxlag)` limits the lag range from $-\text{maxlag}$ to maxlag . This syntax accepts one or two input sequences. `maxlag` defaults to $N - 1$.

`r = xcorr(____,scaleopt)` additionally specifies a normalization option for the cross-correlation or autocorrelation. Any option other than 'none' (the default) requires `x` and `y` to have the same length.

`[r,lags] = xcorr(____)` also returns a vector with the lags at which the correlations are computed.

Examples

Delay Between Two Correlated Signals

Two sensors at different locations measure vibrations caused by a car as it crosses a bridge.

Load the signals and the sample rate, $F_s = 11025$ Hz. Create time vectors and plot the signals. The signal from Sensor 2 arrives at an earlier time than the signal from Sensor 1.

```
load sensorData

t1 = (0:length(s1)-1)/Fs;
t2 = (0:length(s2)-1)/Fs;

subplot(2,1,1)
plot(t1,s1)
title('s_1')

subplot(2,1,2)
plot(t2,s2)
title('s_2')
xlabel('Time (s)')
```

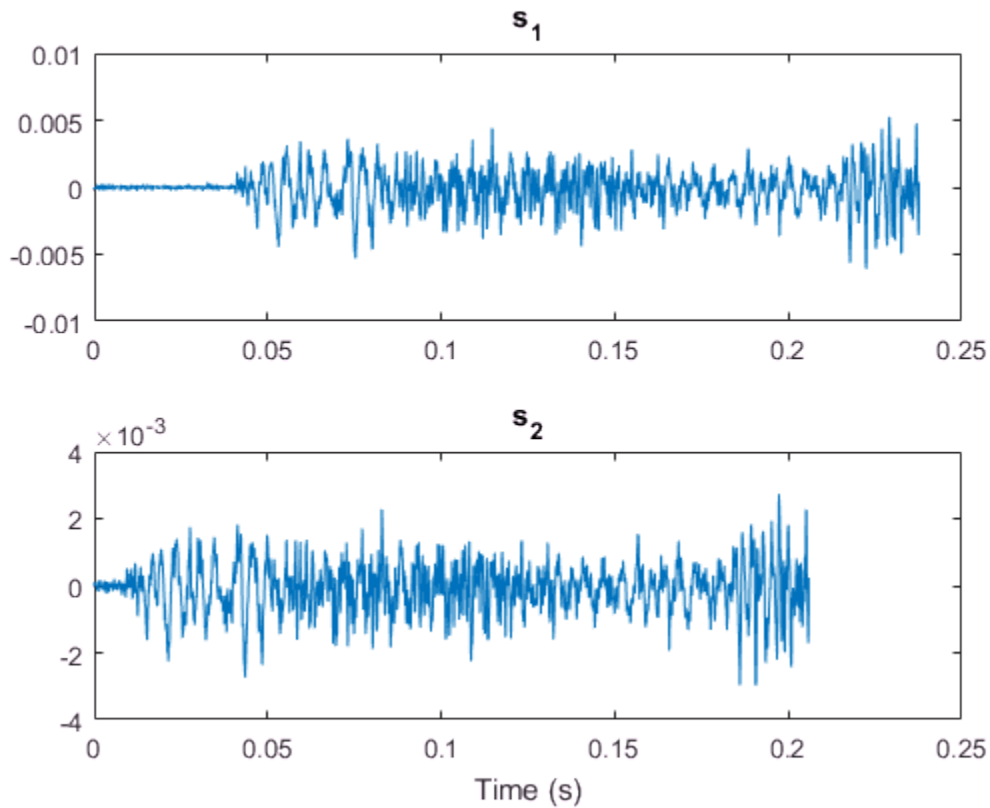

The cross-correlation of the two measurements is maximum at a lag equal to the delay.

Plot the cross-correlation. Express the delay as a number of samples and in seconds.

```
[acor,lag] = xcorr(s2,s1);
```

```
[~,I] = max(abs(acor));  
lagDiff = lag(I)
```

```
lagDiff = -350
```

```
timeDiff = lagDiff/Fs
```

```
timeDiff = -0.0317
```



```
figure
plot(lag,acor)
a3 = gca;
a3.XTick = sort([-3000:1000:3000 lagDiff]);
```

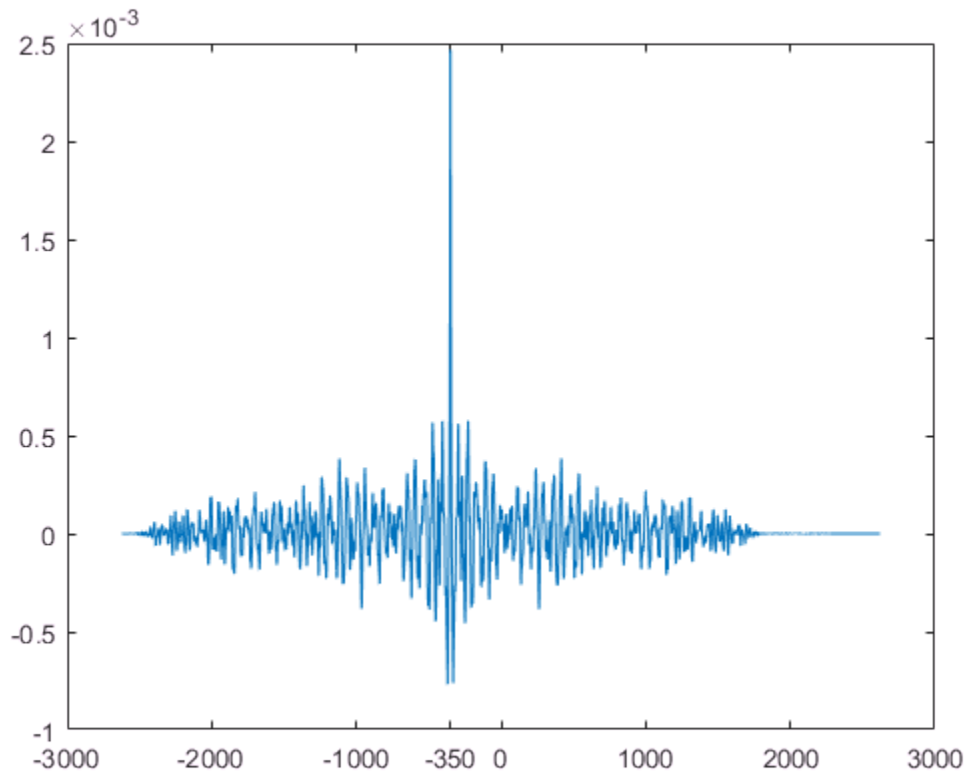

Align the two signals and replot them. Add 1 to the lag difference to account for the one-based indexing used by MATLAB®.

```
s1a1 = s1(-lagDiff+1:end);
t1a1 = (0:length(s1a1)-1)/Fs;
```

```
subplot(2,1,1)
plot(t1a1,s1a1)
```

```
title('s_1, aligned')  
  
subplot(2,1,2)  
plot(t2,s2)  
title('s_2')  
xlabel('Time (s)')
```

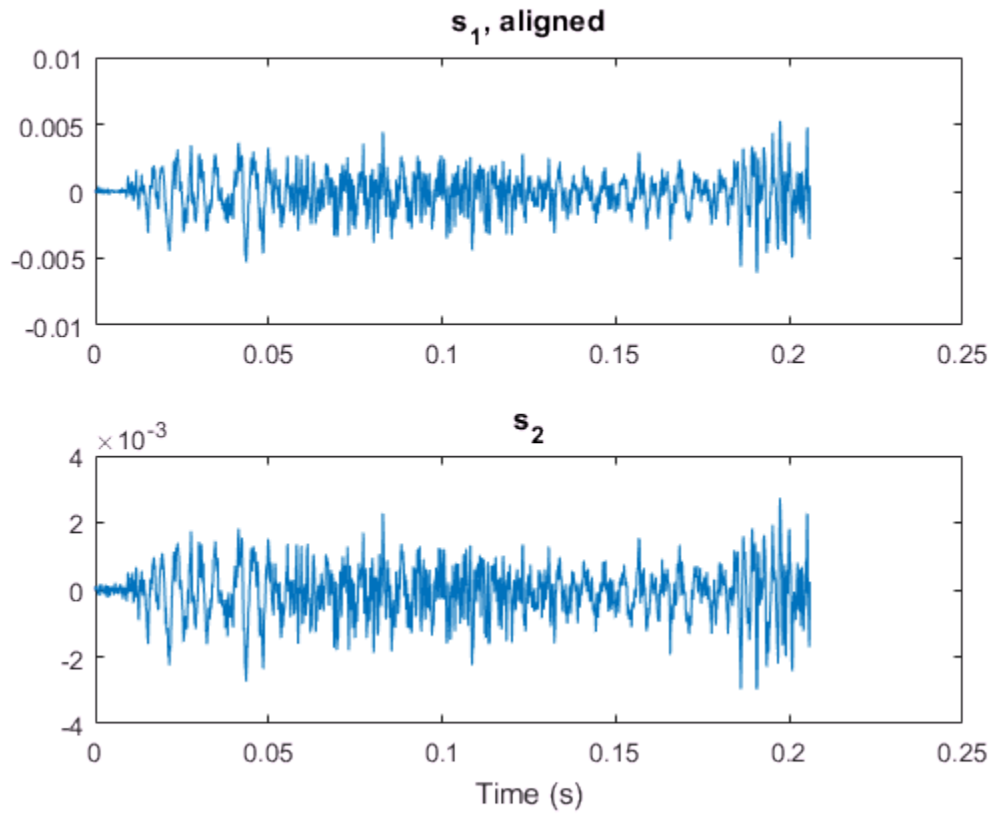

Echo Cancellation

A speech recording includes an echo caused by reflection off a wall. Use autocorrelation to filter it out.

In the recording, a person says the word MATLAB®. Load the data and the sample rate,
 $F_s = 7418$ Hz.

```
load mtlb
```

```
% To hear, type soundsc(mtlb,Fs)
```

Model the echo by adding to the recording a copy of the signal delayed by Δ samples and attenuated by a known factor α : $y(n) = x(n) + \alpha x(n - \Delta)$. Specify a time lag of 0.23 s and an attenuation factor of 0.5.

```
timelag = 0.23;  
delta = round(Fs*timelag);  
alpha = 0.5;  
  
orig = [mtlb;zeros(delta,1)];  
echo = [zeros(delta,1);mtlb]*alpha;  
  
mtEcho = orig + echo;
```

Plot the original, the echo, and the resulting signal.

```
t = (0:length(mtEcho)-1)/Fs;  
  
subplot(2,1,1)  
plot(t,[orig echo])  
legend('Original','Echo')  
  
subplot(2,1,2)  
plot(t,mtEcho)  
legend('Total')  
xlabel('Time (s)')
```

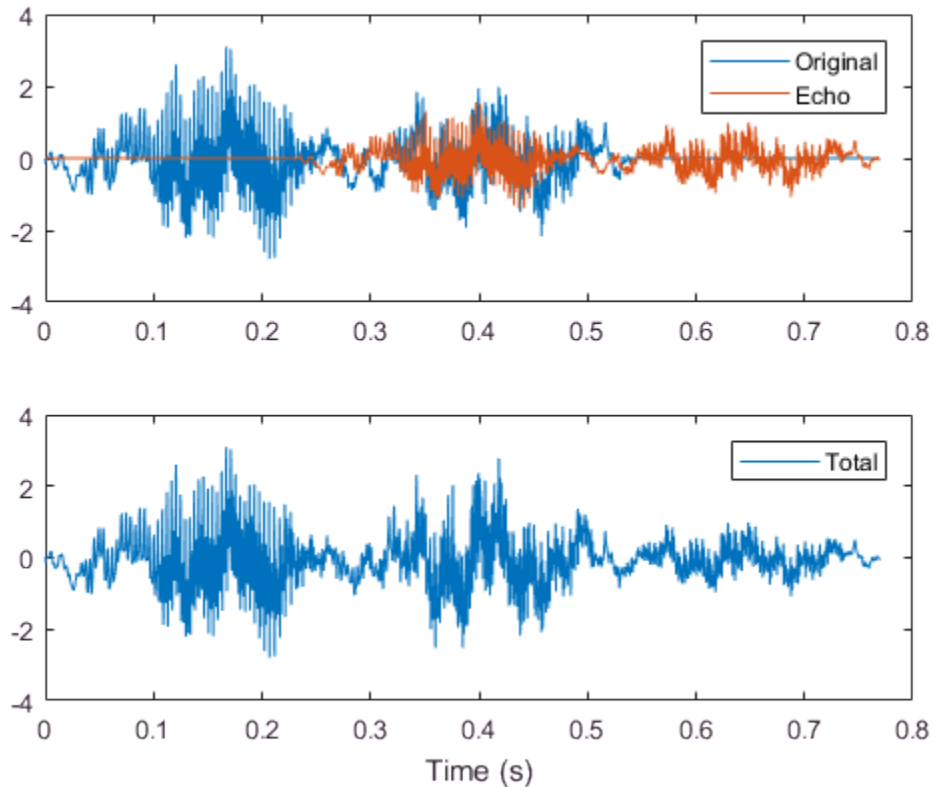

```
% To hear, type soundsc(mtEcho,Fs)
```

Compute an unbiased estimate of the signal autocorrelation. Select and plot the section that corresponds to lags greater than zero.

```
[Rmm,lags] = xcorr(mtEcho,'unbiased');
```

```
Rmm = Rmm(lags>0);  
lags = lags(lags>0);
```

```
figure  
plot(lags/Fs,Rmm)  
xlabel('Lag (s)')
```

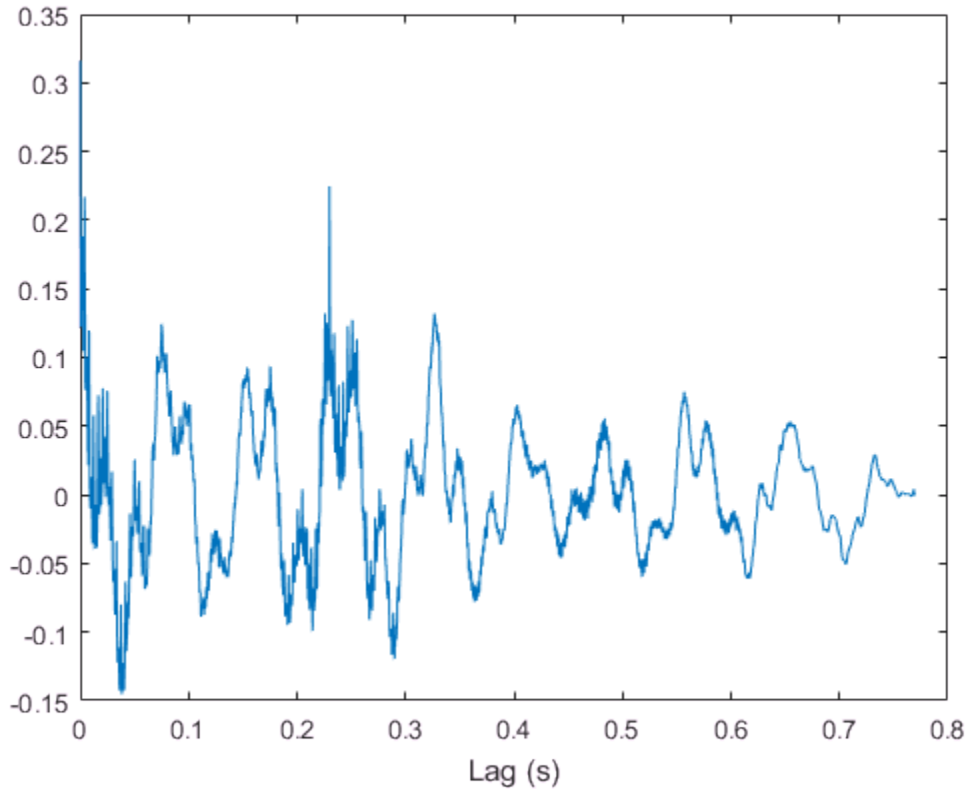

The autocorrelation has a sharp peak at the lag at which the echo arrives. Cancel the echo by filtering the signal through an IIR system whose output, w , obeys $w(n) + \alpha w(n - \Delta) = y(n)$.

```
[~,dl] = findpeaks(Rmm,lags,'MinPeakHeight',0.22);
mtNew = filter(1,[1 zeros(1,dl-1) alpha],mtEcho);
```

Plot the filtered signal and compare to the original.

```
subplot(2,1,1)
plot(t,orig)
legend('Original')
```

```
subplot(2,1,2)
plot(t,mtNew)
legend('Filtered')
xlabel('Time (s)')
```

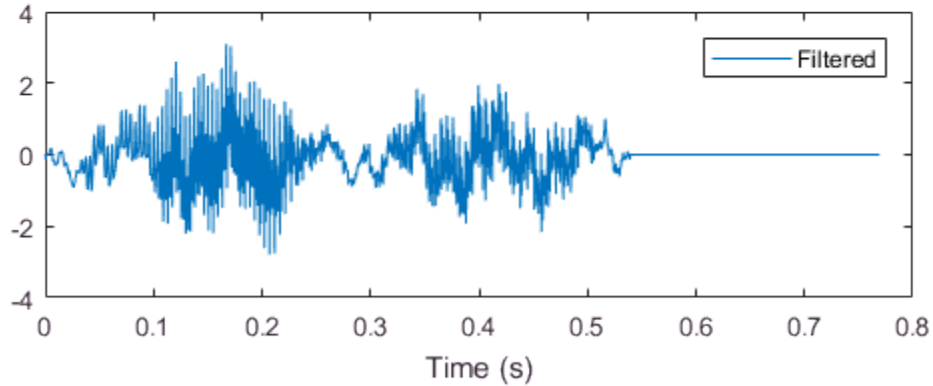
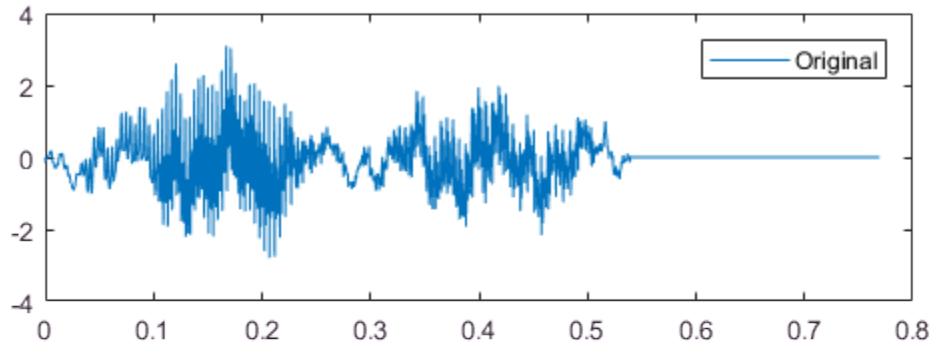

```
% To hear, type soundsc(mtNew,Fs)
```

Cross-Correlation with Multichannel Input

Generate three 11-sample exponential sequences given by 0.4^n , 0.7^n , and 0.999^n , with $n \geq 0$. Use `stem3` to plot the sequences side by side.

```
N = 11;  
n = (0:N-1)';  
  
a = 0.4;  
b = 0.7;  
c = 0.999;  
  
xabc = [a.^n b.^n c.^n];  
  
stem3(n,1:3,xabc','filled')  
ax = gca;  
ax.YTick = 1:3;  
view(37.5,30)
```

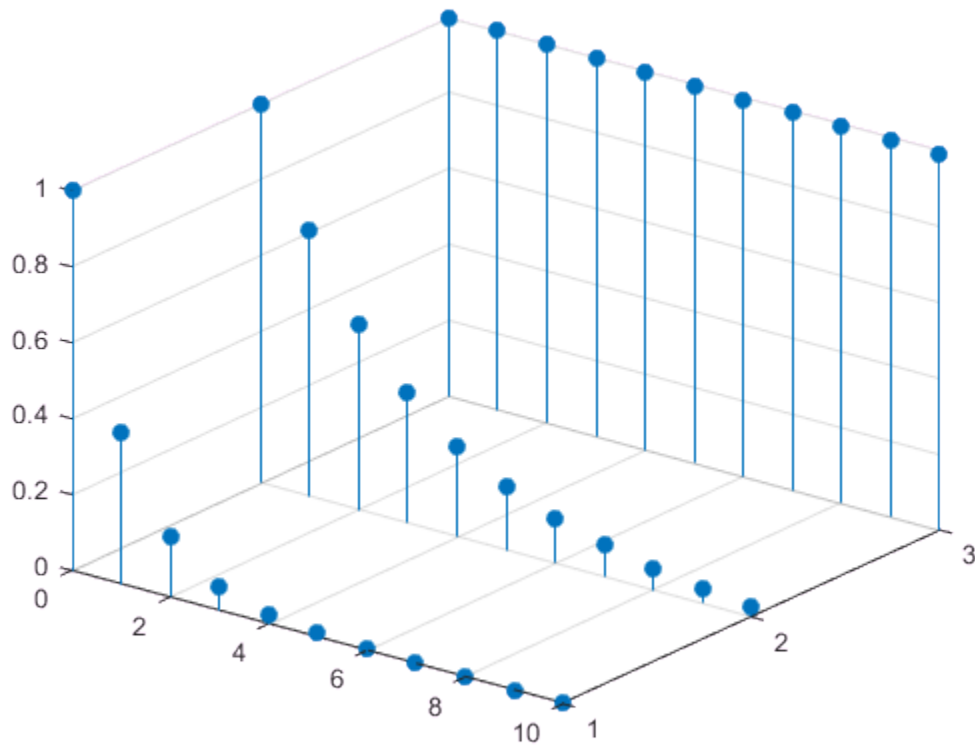

Compute the autocorrelations and mutual cross-correlations of the sequences. Output the lags so you do not have to keep track of them. Normalize the result so the autocorrelations have unit value at zero lag.

```
[cr,lgs] = xcorr(xabc, 'coeff');  
  
for row = 1:3  
    for col = 1:3  
        nm = 3*(row-1)+col;  
        subplot(3,3,nm)  
        stem(lgs,cr(:,nm),'.')  
        title(sprintf('c_{%d%d}',row,col))  
        ylim([0 1])  
    end  
end
```

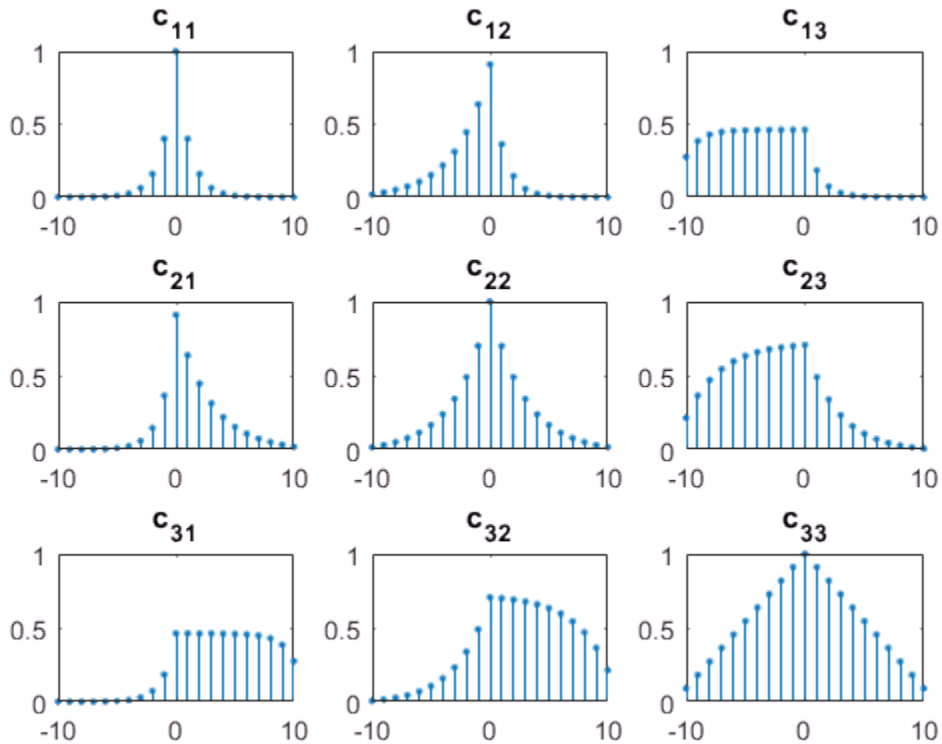
Restrict the calculation to lags between -5 and 5 .

```
[cr,lgs] = xcorr(xabc,5,'coeff');

for row = 1:3
    for col = 1:3
        nm = 3*(row-1)+col;
        subplot(3,3,nm)
        stem(lgs,cr(:,nm),'.')
        title(sprintf('c_{%d%d}',row,col))
        ylim([0 1])
    end
end
```

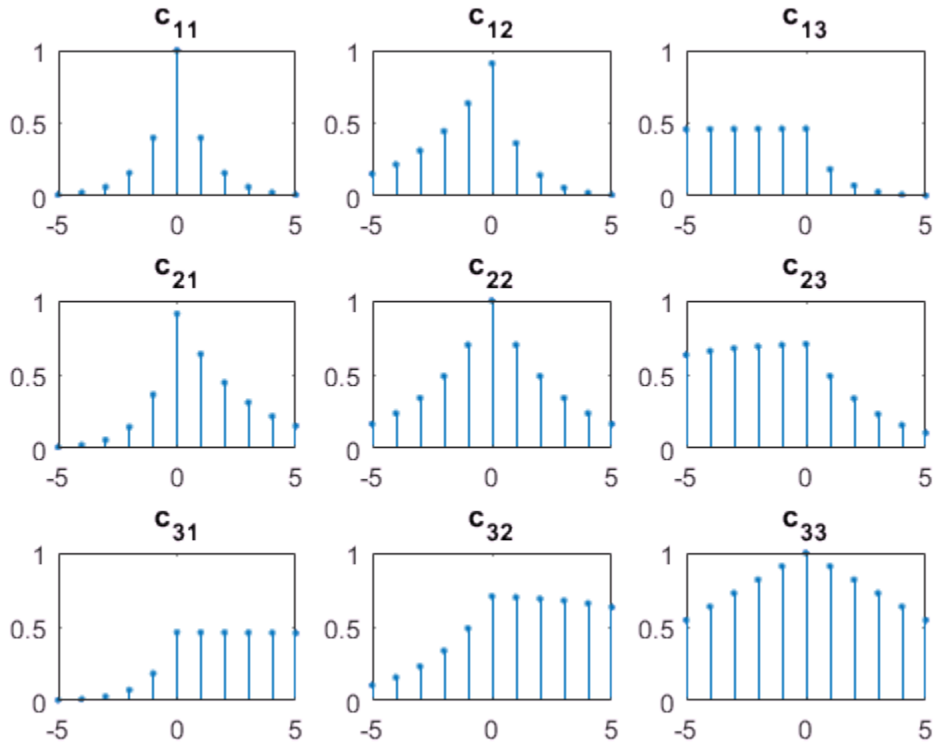

Compute unbiased estimates of the autocorrelations and mutual cross-correlations. By default, the lags run between $-(N - 1)$ and $N - 1$.

```
cu = xcorr(xabc, 'unbiased');

for row = 1:3
    for col = 1:3
        nm = 3*(row-1)+col;
        subplot(3,3,nm)
        stem(-(N-1):(N-1),cu(:,nm),'.')
        title(sprintf('c_{%d%d}',row,col))
    end
end
```

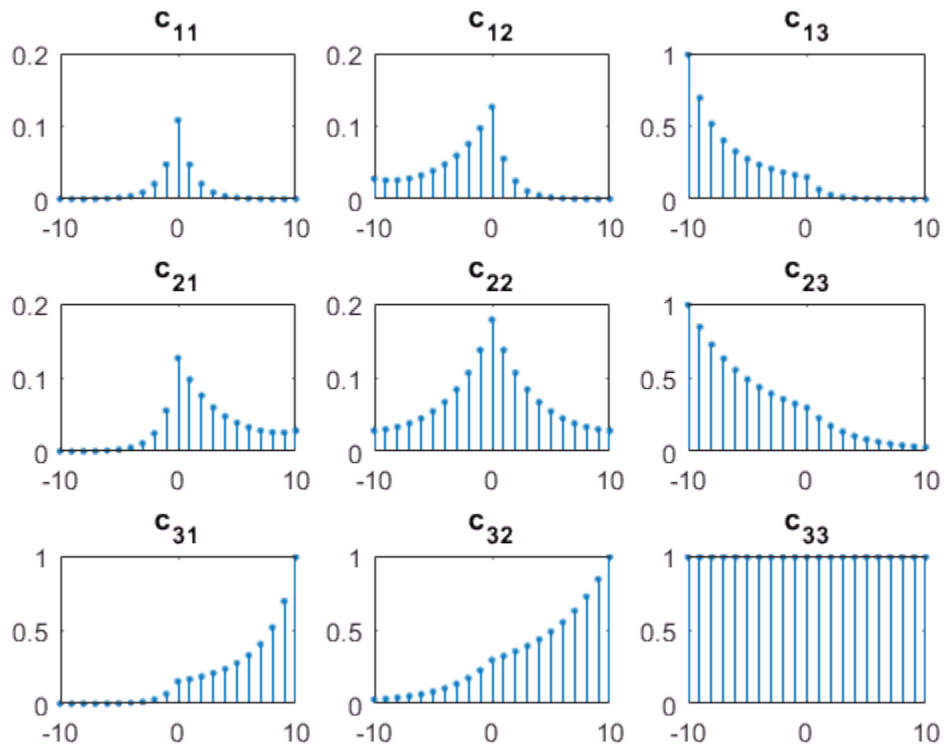

Autocorrelation Function of Exponential Sequence

Compute the autocorrelation function of a 28-sample exponential sequence, $x = 0.95^n$ for $n \geq 0$.

`a = 0.95;`

`N = 28;`

`n = 0:N-1;`

`lags = -(N-1):(N-1);`

```
x = a.^n;  
c = xcorr(x);
```

Determine c analytically to check the correctness of the result. Use a larger sample rate to simulate a continuous situation. The autocorrelation function of the sequence

$x(n) = a^n$ for $n \geq 0$, with $|a| < 1$, is

$$c(n) = \frac{1 - a^{2(N-|n|)}}{1 - a^2} \times a^{|n|}.$$

```
fs = 10;  
nn = -(N-1):1/fs:(N-1);  
dd = (1-a^(2*(N-abs(nn))))/(1-a^2).*a.^abs(nn);
```

Plot the sequences on the same figure.

```
stem(lags,c);  
hold on  
plot(nn,dd)  
xlabel('Lag')  
legend('xcorr','Analytic')  
hold off
```

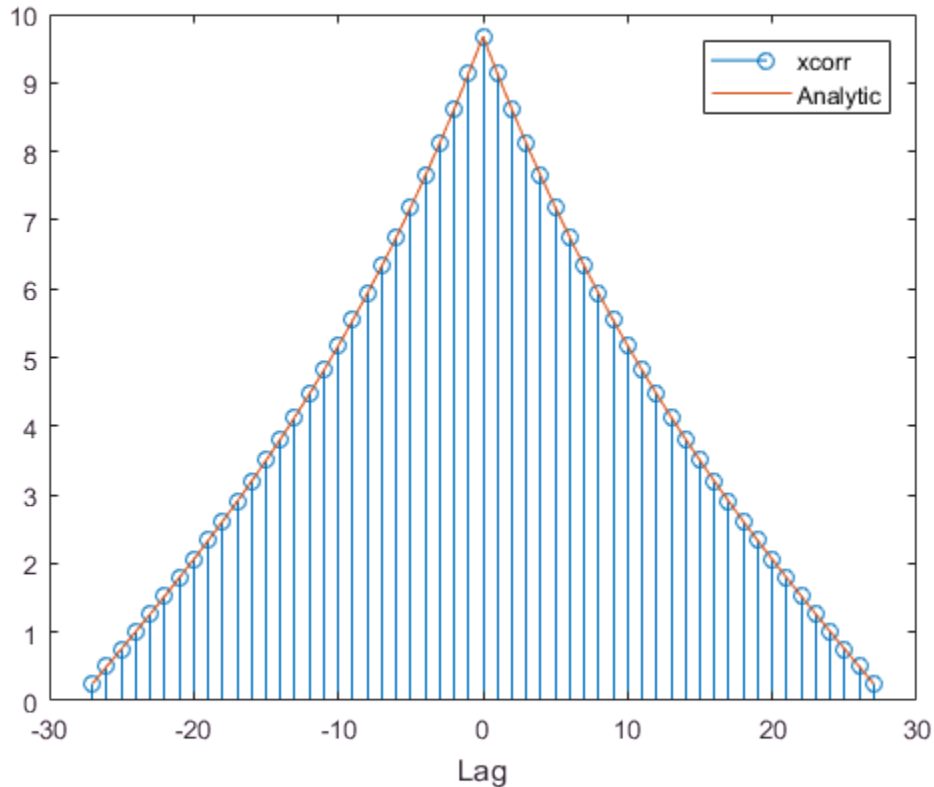

Repeat the calculation, but now find an *unbiased* estimate of the autocorrelation. Verify that the unbiased estimate is given by $c_u(n) = c(n)/(N - |n|)$.

```
cu = xcorr(x, 'unbiased');
du = dd./(N-abs(nn));

stem(lags,cu);
hold on
plot(nn,du)
xlabel('Lag')
legend('xcorr','Analytic')
hold off
```

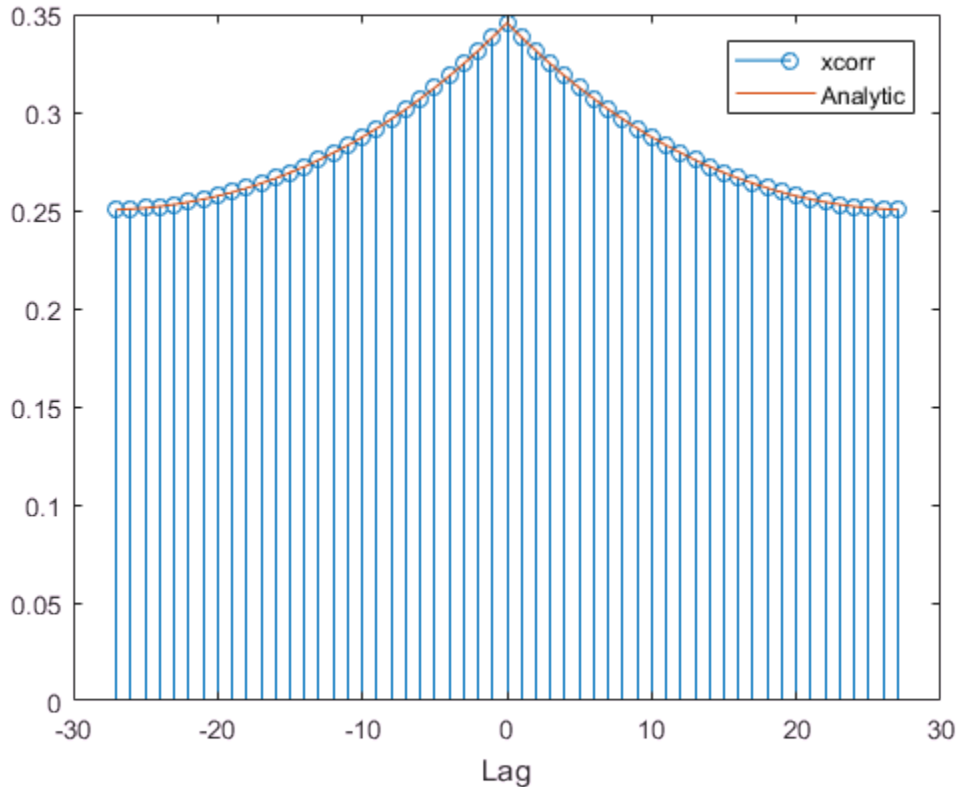

Repeat the calculation, but now find a *biased* estimate of the autocorrelation. Verify that the biased estimate is given by $c_b(n) = c(n)/N$.

```
cb = xcorr(x, 'biased');
db = dd/N;

stem(lags,cb);
hold on
plot(nn,db)
xlabel('Lag')
legend('xcorr','Analytic')
hold off
```

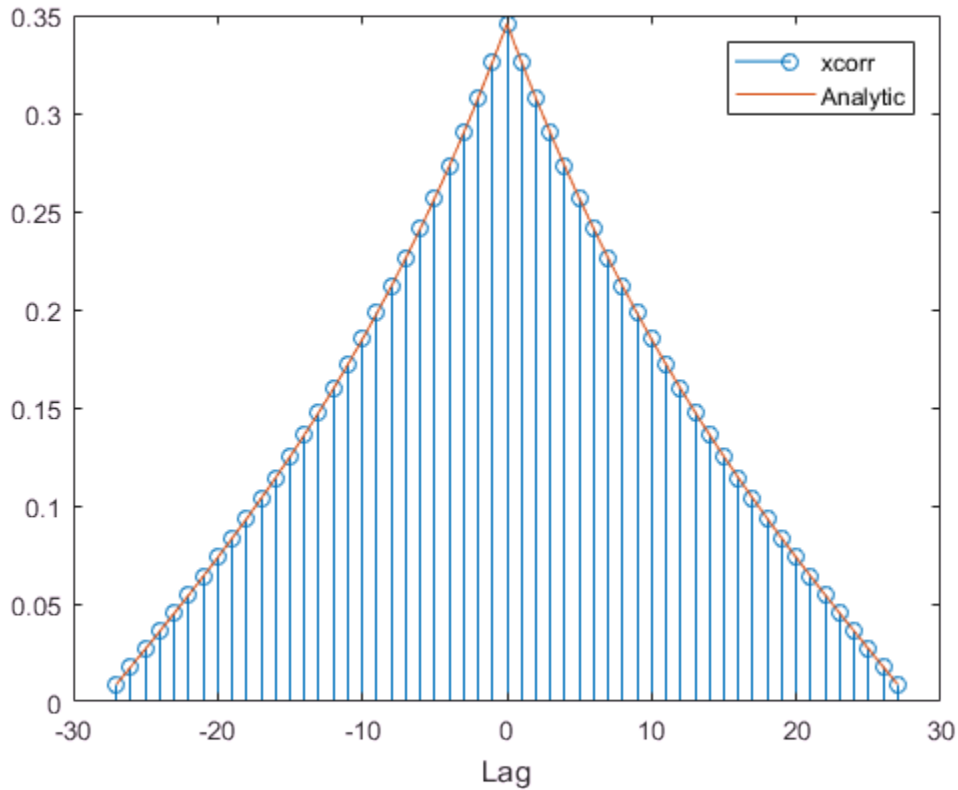

Find an estimate of the autocorrelation whose value at zero lag is unity.

```

cz = xcorr(x, 'coeff');

dz = dd/max(dd);

stem(lags,cz);
hold on
plot(nn,dz)
xlabel('Lag')
legend('xcorr','Analytic')
hold off

```

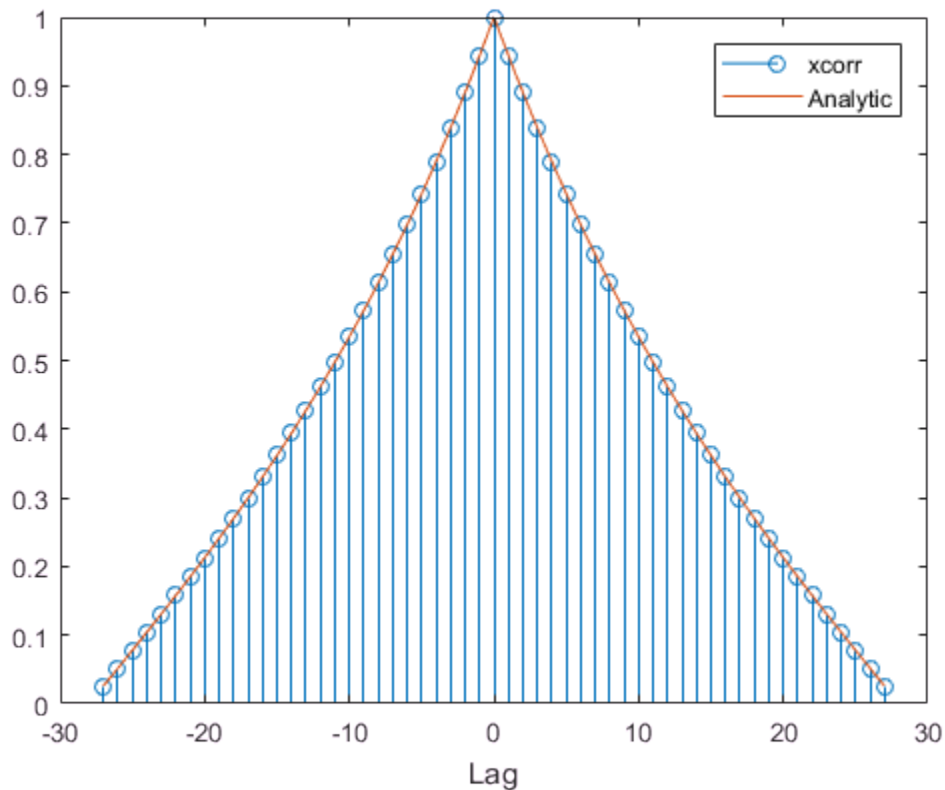

Cross-Correlation of Two Exponential Sequences

Compute and plot the cross-correlation of two 16-sample exponential sequences,

$$x_a = 0.84^n \text{ and } x_b = 0.92^n, \text{ with } n \geq 0.$$

```
N = 16;  
n = 0:N-1;
```

```
a = 0.84;  
b = 0.92;
```



```

xa = a.^n;
xb = b.^n;

r = xcorr(xa,xb);

stem(-(N-1):(N-1),r)

```

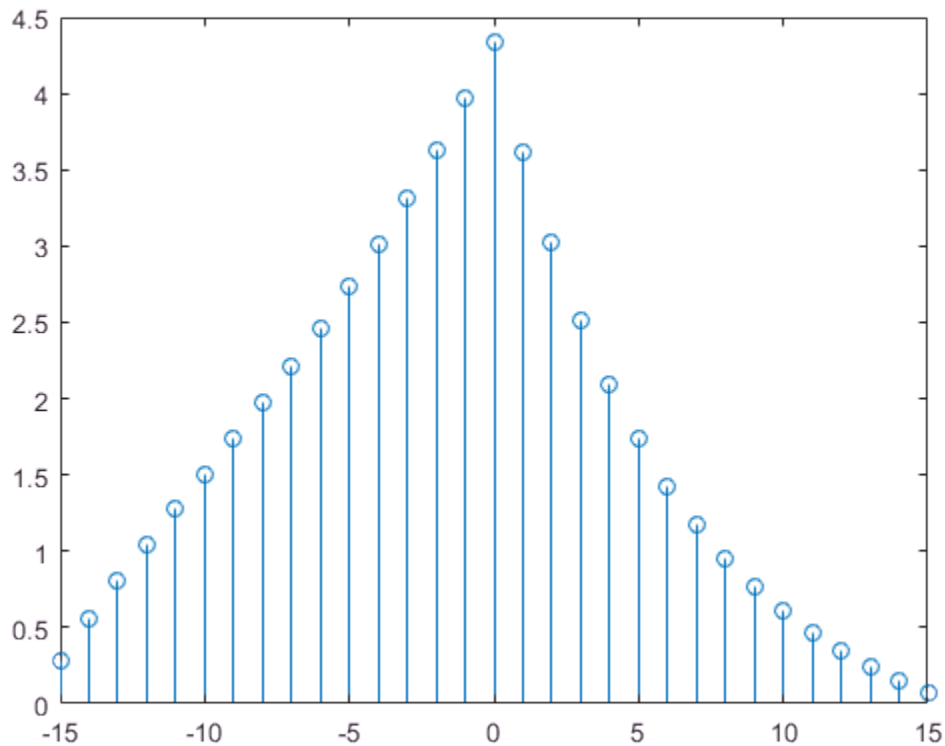

Determine \mathcal{C} analytically to check the correctness of the result. Use a larger sample rate to simulate a continuous situation. The cross-correlation function of the sequences $x_a(n) = a^n$ and $x_b(n) = b^n$ for $n \geq 0$, with $0 < a, b < 1$, is

$$c_{ab}(n) = \frac{1 - (ab)^{N-|n|}}{1 - ab} \times \begin{cases} a^n, & n > 0, \\ 1, & n = 0, \\ b^{-n}, & n < 0. \end{cases}$$

```
fs = 10;
nn = -(N-1):1/fs:(N-1);

cn = (1 - (a*b).^(N-abs(nn)))/(1 - a*b) .* ...
      (a.^nn.*(nn>0) + (nn==0) + b.^-(nn).*(nn<0));
```

Plot the sequences on the same figure.

```
hold on
plot(nn,cn)

xlabel('Lag')
legend('xcorr','Analytic')
```

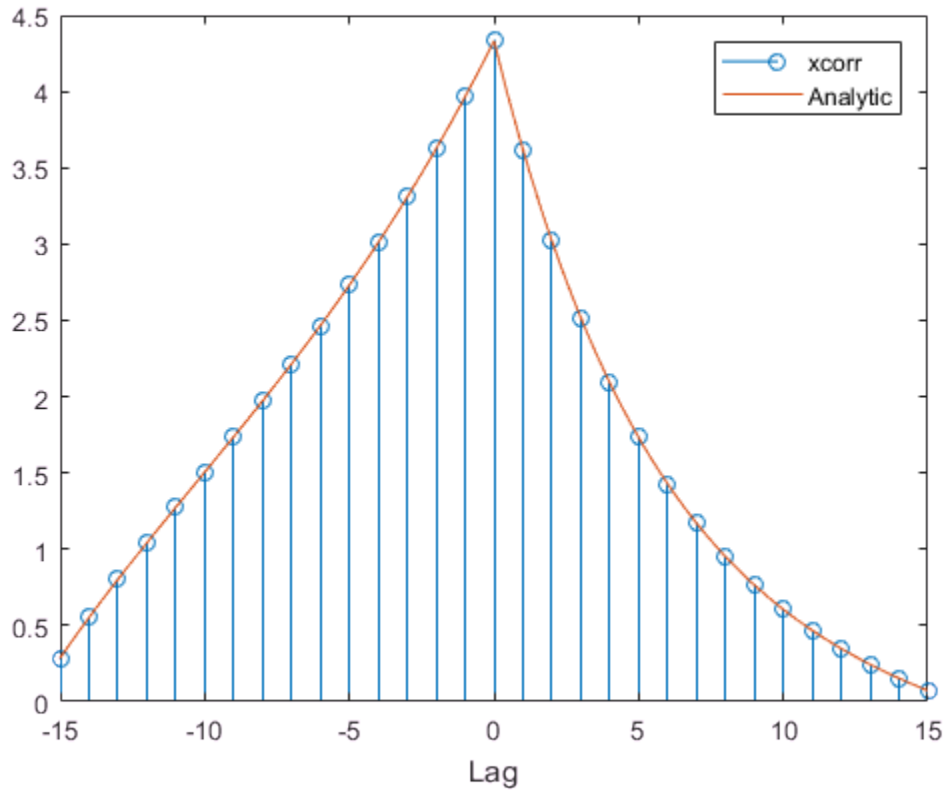

Verify that switching the order of the operands reverses the sequence.

figure

```
stem(-(N-1):(N-1),xcorr(xb,xa))
```

```
hold on
```

```
stem(-(N-1):(N-1),fliplr(r),'--*')
```

```
xlabel('Lag')
```

```
legend('xcorr(x_b,x_a)','fliplr(xcorr(x_a,x_b))')
```

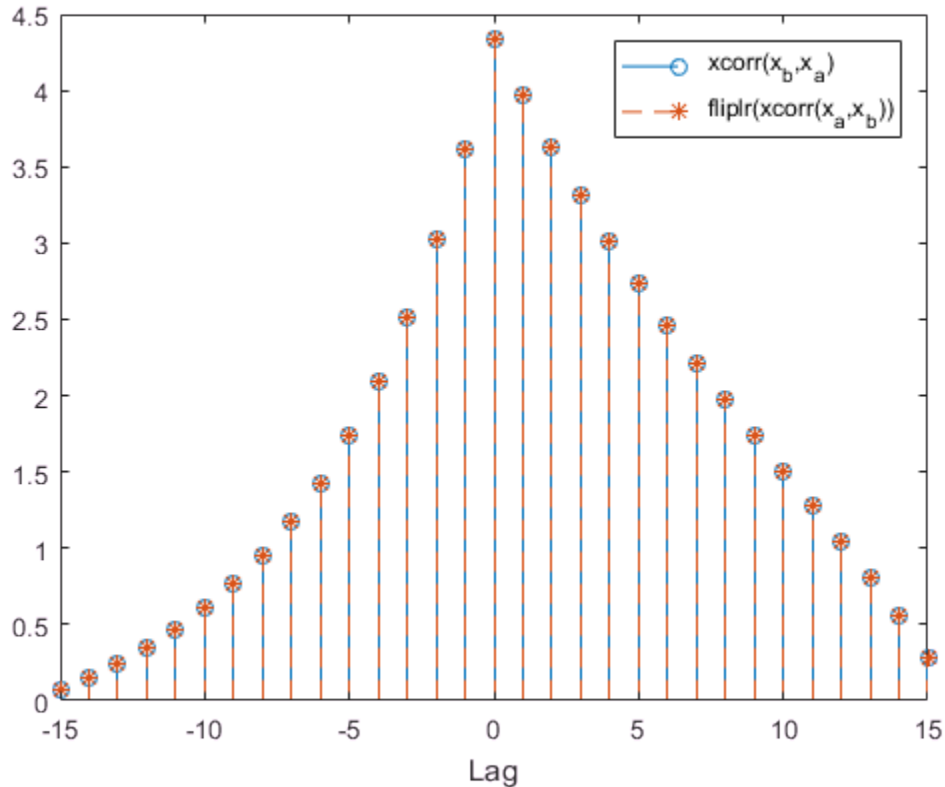

Generate the 20-sample exponential sequence $x_c = 0.77^n$. Compute and plot its cross-correlations with x_a and x_b . Output the lags to make the plotting easier. `xcorr` appends zeros at the end of the shorter sequence to match the length of the longer one.

```
xc = 0.77.^(0:20-1);
```

```
[xca, la] = xcorr(xa, xc);
```

```
[xcb, lb] = xcorr(xb, xc);
```

```
figure
```

```
subplot(2,1,1)
```

```
stem(la,xca)
subplot(2,1,2)
stem(lb,xcb)
xlabel('Lag')
```

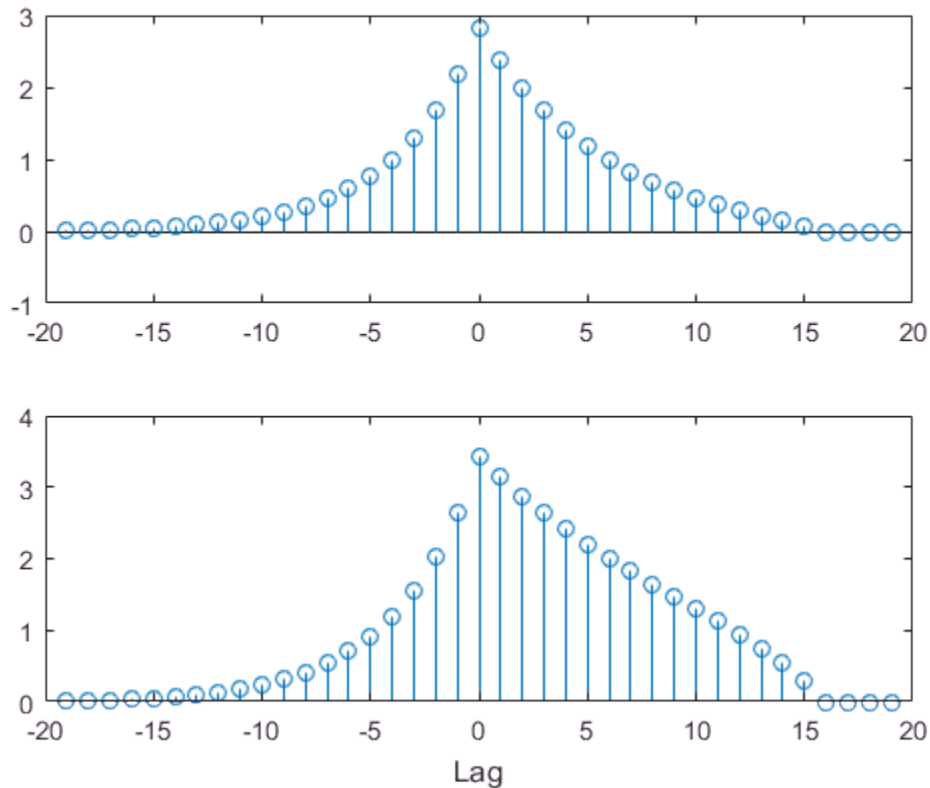

GPU Acceleration for Autocorrelation Sequence Estimation

This example requires Parallel Computing Toolbox software and a CUDA-enabled NVIDIA GPU with compute capability 1.3 or above. See GPU System Requirements for details.

Create a signal consisting of a 10 Hz sine wave in additive noise, sampled at 1 kHz. Use `gpuArray` to create a `gpuArray` object stored on your computer's GPU.

```
t = 0:0.001:10-0.001;  
x = cos(2*pi*10*t) + randn(size(t));  
X = gpuArray(x);
```

Compute the normalized autocorrelation sequence to lag 200.

```
[xc,lags] = xcorr(X,200,'coeff');
```

The output, `xc`, is a `gpuArray` object.

Use `gather` to transfer the data from the GPU to the MATLAB workspace as a double-precision vector.

```
xc = gather(xc);
```

- “Find a Signal in a Measurement”
- “Align Two Simple Signals”
- “Measuring Signal Similarities”
- “Accelerating Correlation with GPUs”

Input Arguments

x — Input array

vector | matrix | `gpuArray` object

Input array, specified as a vector, a matrix, or a `gpuArray` object.

See “GPU Computing” (Parallel Computing Toolbox) and GPU System Requirements for details on using `xcorr` with `gpuArray` objects.

Example: `sin(2*pi*(0:9)/10) + randn([1 10])/10` specifies a noisy sinusoid as a row vector.

Example: `sin(2*pi*[0.1;0.3]*(0:39))' + randn([40 2])/10` specifies a two-channel noisy sinusoid.

Example: `gpuArray(sin(2*pi*(0:9)/10) + randn([1 10])/10)` specifies a noisy sinusoid as a `gpuArray` object.

Data Types: `single` | `double`

Complex Number Support: Yes

y — Input array

vector | gpuArray object

Input array, specified as a vector or a gpuArray object.

Data Types: single | double

Complex Number Support: Yes

maxlag — Maximum lag

integer scalar

Maximum lag, specified as an integer scalar. If you specify `maxlag`, the returned cross-correlation sequence ranges from `-maxlag` to `maxlag`. If you do not specify `maxlag`, the lag range equals $2N - 1$, where N is the greater of the lengths of `x` and `y`.

Data Types: single | double

scaleopt — Normalization option

'none' (default) | 'biased' | 'unbiased' | 'coeff'

Normalization option, specified as one of the following:

- 'none' — Raw, unscaled cross-correlation. This is the only allowed option when `x` and `y` have different lengths.
- 'biased' — Biased estimate of the cross-correlation:

$$\hat{R}_{xy,\text{biased}}(m) = \frac{1}{N} \hat{R}_{xy}(m).$$

- 'unbiased' — Unbiased estimate of the cross-correlation:

$$\hat{R}_{xy,\text{unbiased}}(m) = \frac{1}{N - |m|} \hat{R}_{xy}(m).$$

- 'coeff' — Normalizes the sequence so that the autocorrelations at zero lag equal 1:

$$\hat{R}_{xy,\text{coeff}}(m) = \frac{1}{\sqrt{\hat{R}_{xx}(0)\hat{R}_{yy}(0)}} \hat{R}_{xy}(m).$$

Data Types: char

Output Arguments

r — Cross-correlation or autocorrelation sequence

vector | matrix | gpuArray object

Cross-correlation sequence, returned as a vector, a matrix, or a `gpuArray` object.

If \mathbf{x} is an $M \times N$ signal matrix representing N channels in its columns, then `xcorr(x)` returns a $(2M - 1) \times N^2$ matrix with the autocorrelations and mutual cross-correlations of the channels of \mathbf{x} . If you specify `maxlag`, then \mathbf{r} has size $(2 \times \text{maxlag} - 1) \times N^2$.

For example, if \mathbf{S} is a three-channel signal, $\mathbf{S} = (x_1 \quad x_2 \quad x_3)$, then the result of $\mathbf{R} = \text{xcorr}(\mathbf{S})$ is organized as

$$\mathbf{R} = \begin{pmatrix} R_{x_1 x_1} & R_{x_1 x_2} & R_{x_1 x_3} & R_{x_2 x_1} & R_{x_2 x_2} & R_{x_2 x_3} & R_{x_3 x_1} & R_{x_3 x_2} & R_{x_3 x_3} \end{pmatrix}.$$

lags — Lag indices

vector

Lag indices, returned as a vector.

Definitions

Cross-Correlation and Autocorrelation

The result of `xcorr` can be interpreted as an estimate of the correlation between two random sequences or as the deterministic correlation between two deterministic signals.

The true cross-correlation sequence of two jointly stationary random processes, x_n and y_n , is given by

$$R_{xy}(m) = E\{x_{n+m}y_n^*\} = E\{x_n y_{n-m}^*\},$$

where $-\infty < n < \infty$, the asterisk denotes complex conjugation, and E is the expected value operator. `xcorr` can only estimate the sequence because, in practice, only a finite segment of one realization of the infinite-length random process is available.

By default, `xcorr` computes raw correlations with no normalization:

$$\hat{R}_{xy}(m) = \begin{cases} \sum_{n=0}^{N-m-1} x_{n+m} y_n^*, & m \geq 0, \\ \hat{R}_{yx}^*(-m), & m < 0. \end{cases}$$

The output vector, `c`, has elements given by

$$c(m) = R_{xy}(m - N), \quad m = 1, 2, \dots, 2N - 1.$$

In general, the correlation function requires normalization to produce an accurate estimate. You can control the normalization of the correlation by using the input argument `scaleopt`.

References

- [1] Buck, John R., Michael M. Daniel, and Andrew C. Singer. *Computer Explorations in Signals and Systems Using MATLAB*. 2nd Edition. Upper Saddle River, NJ: Prentice Hall, 2002.
- [2] Stoica, Petre, and Randolph Moses. *Spectral Analysis of Signals*. Upper Saddle River, NJ: Prentice Hall, 2005.

Extended Capabilities

C/C++ Code Generation

Generate C and C++ code using MATLAB® Coder™.

Usage notes and limitations:

Leading ones in `size(x)` must be constant for every input `x`. If `x` is variable-size and is a row vector, it must be 1-by-`:`. It cannot be `:-by-:` with `size(x,1) = 1` at run time.

See Also

See Also

`conv` | `corrcoef` | `cov` | `gather` | `gpuArray` | `xcorr2` | `xcov`

Topics

“Find a Signal in a Measurement”

“Align Two Simple Signals”

“Measuring Signal Similarities”

“Accelerating Correlation with GPUs”

Introduced before R2006a

xcorr2

2-D cross-correlation

Syntax

```
C = xcorr2(A,B)
C = xcorr2(A)
C = xcorr2(gpuArrayA,gpuArrayB)
```

Description

`C = xcorr2(A,B)` returns the cross-correlation of matrices **A** and **B** with no scaling. `xcorr2` is the two-dimensional version of `xcorr`.

`C = xcorr2(A)` is the autocorrelation matrix of input matrix **A**. It is identical to `xcorr2(A,A)`.

`C = xcorr2(gpuArrayA,gpuArrayB)` returns the cross-correlation of two matrices of class `gpuArray`. The output cross-correlation matrix, **C**, is also a `gpuArray` object. See “Establish Arrays on a GPU” (Parallel Computing Toolbox) for details on `gpuArray` objects.

Note: Using `xcorr2` with `gpuArray` objects requires Parallel Computing Toolbox software and a CUDA-enabled NVIDIA GPU with compute capability 1.3 or above. See System Requirements for details.

Examples

Output Matrix Size and Element Computation

Create two matrices, **M1** and **M2**.

```
M1 = [17 24 1 8 15;
```

```

23  5  7 14 16;
 4  6 13 20 22;
10 12 19 21  3;
11 18 25  2  9];

```

```

M2 = [8 1 6;
      3 5 7;
      4 9 2];

```

M1 is 5-by-5 and M2 is 3-by-3, so their cross-correlation has size $(5+3-1)$ -by- $(5+3-1)$, or 7-by-7. In terms of lags, the resulting matrix is

$$C = \begin{pmatrix} c_{-2,-2} & c_{-2,-1} & c_{-2,0} & c_{-2,1} & c_{-2,2} & c_{-2,3} & c_{-2,4} \\ c_{-1,-2} & c_{-1,-1} & c_{-1,0} & c_{-1,1} & c_{-1,2} & c_{-1,3} & c_{-1,4} \\ c_{0,-2} & c_{0,-1} & c_{0,0} & c_{0,1} & c_{0,2} & c_{0,3} & c_{0,4} \\ c_{1,-2} & c_{1,-1} & c_{1,0} & c_{1,1} & c_{1,2} & c_{1,3} & c_{1,4} \\ c_{2,-2} & c_{2,-1} & c_{2,0} & c_{2,1} & c_{2,2} & c_{2,3} & c_{2,4} \\ c_{3,-2} & c_{3,-1} & c_{3,0} & c_{3,1} & c_{3,2} & c_{3,3} & c_{3,4} \\ c_{4,-2} & c_{4,-1} & c_{4,0} & c_{4,1} & c_{4,2} & c_{4,3} & c_{4,4} \end{pmatrix}.$$

As an example, compute the element $c_{0,2}$ (or $C(3,5)$ in MATLAB®, since M2 is 3-by-3). Line up the two matrices so their $(1,1)$ elements coincide. This placement corresponds to $c_{0,0}$. To find $c_{0,2}$, slide M2 two rows to the right.

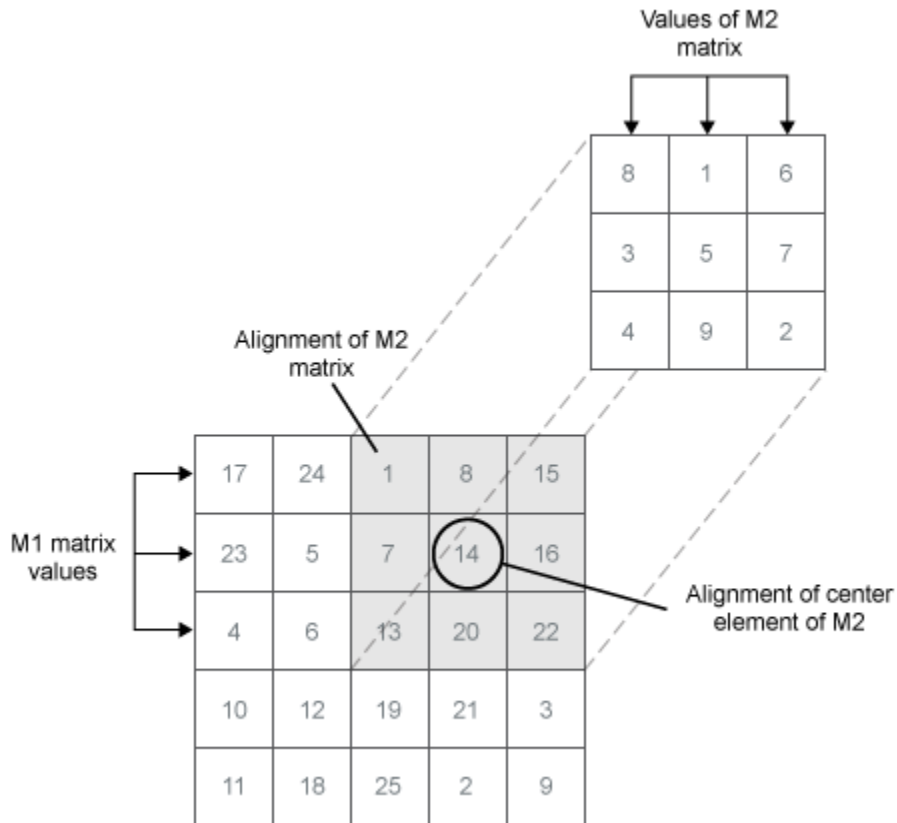

Now M2 is on top of the matrix M1 (1:3,3:5). Compute the element-by-element products and sum them. The answer should be

$$1 \times 8 + 7 \times 3 + 13 \times 4 + 8 \times 1 + 14 \times 5 + 20 \times 9 + 15 \times 6 + 16 \times 7 + 22 \times 2 = 585.$$

```
[r2,c2] = size(M2);
```

```
CC = sum(sum(M1(0+(1:r2),2+(1:c2)).*M2))
```

```
CC = 585
```

Verify the result using `xcorr2`.

```
D = xcorr2(M1,M2);
```

DD = D(0+r2,2+c2)

DD = 585

Two-Dimensional Cross-Correlation of Arbitrary Complex Matrices

Given a matrix \mathcal{X} of size $M \times N$ and a matrix \mathcal{H} of size $P \times Q$, their two-dimensional cross-correlation, $\mathcal{C} = \mathcal{X} \star \mathcal{H}$, is a matrix of size $(M + P - 1) \times (N + Q - 1)$ with elements

$$\mathcal{C}(k, l) = \text{Tr} \{ \tilde{\mathcal{X}} \tilde{\mathcal{H}}_{kl}^\dagger \} \quad \begin{array}{l} 1 \leq k \leq M + P - 1, \\ 1 \leq l \leq N + Q - 1. \end{array}$$

Tr is the trace and the dagger denotes Hermitian conjugation. The matrices $\tilde{\mathcal{X}}$ and $\tilde{\mathcal{H}}_{kl}$ have size $(M + 2(P - 1)) \times (N + 2(Q - 1))$ and nonzero elements given by

$$\tilde{\mathcal{X}}(m, n) = \mathcal{X}(m - P + 1, n - Q + 1), \quad \begin{array}{l} P \leq m \leq M + P - 1, \\ Q \leq n \leq N + Q - 1 \end{array}$$

and

$$\tilde{\mathcal{H}}_{kl}(p, q) = \mathcal{H}(p - k + 1, q - l + 1), \quad \begin{array}{l} k \leq p \leq P + k - 1, \\ l \leq q \leq Q + l - 1. \end{array}$$

Calling `xcorr2` is equivalent to this procedure for general complex matrices of arbitrary size.

Create two complex matrices, \mathcal{X} of size 7×22 and \mathcal{H} of size 6×17 .

```
X = randn([7 22])+1j*randn([7 22]);
H = randn([6 17])+1j*randn([6 17]);
```

```
[M,N] = size(X);
m = 1:M;
n = 1:N;
```

```
[P,Q] = size(H);
p = 1:P;
q = 1:Q;
```

Initialize \tilde{x} and C .

```
Xt = zeros([M+2*(P-1) N+2*(Q-1)]);
Xt(m+P-1,n+Q-1) = X;
C = zeros([M+P-1 N+Q-1]);
```

Compute the elements of C by looping over k and l . Reset \tilde{H}_{kl} to zero at each step. Save time and memory by summing element products instead of multiplying and taking the trace.

```
for k = 1:M+P-1
    for l = 1:N+Q-1
        Hk1 = zeros([M+2*(P-1) N+2*(Q-1)]);
        Hk1(p+k-1,q+1-1) = H;
        C(k,l) = sum(sum(Xt.*conj(Hk1)));
    end
end
```

```
max(max(abs(C-xcorr2(X,H))))
```

```
ans = 2.9192e-14
```

The answer coincides to machine precision with the output of `xcorr2`.

Align Two Images Using Cross-Correlation

Use cross-correlation to find where a section of an image fits in the whole. Cross-correlation enables you to find the regions in which two signals most resemble each other. For two-dimensional signals, like images, use `xcorr2`.

Load a black-and-white test image into the workspace. Display it with `imagesc`.

```
load durer
img = X;
White = max(max(img));

imagesc(img)
```

```
axis image off  
colormap gray  
title('Original')
```

Original

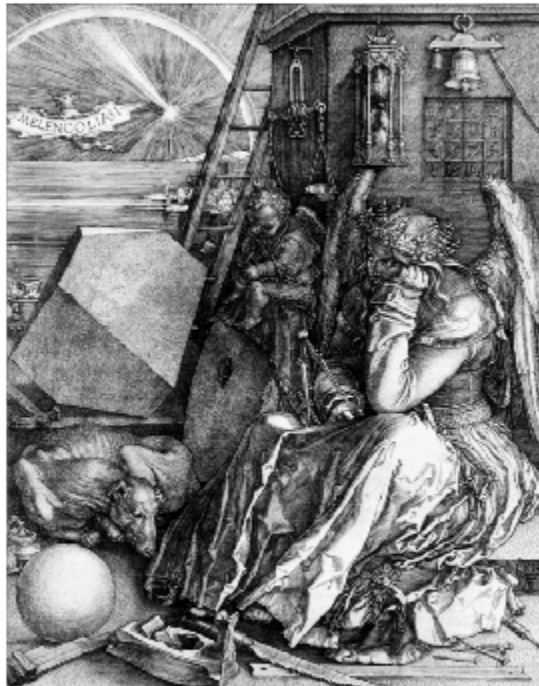

Select a rectangular section of the image. Display the larger image with the section missing.

```
x = 435;  
X = 535;  
szx = x:X;
```

```
y = 62;  
Y = 182;  
szy = y:Y;
```



```
Sect = img(szx,szy);

king = img;
king(szx,szy) = White;

kumg = White*ones(size(img));
kumg(szx,szy) = Sect;

subplot(1,2,1)
imagesc(king)
axis image off
colormap gray
title('Image')

subplot(1,2,2)
imagesc(kumg)
axis image off
colormap gray
title('Section')
```

Image



Section

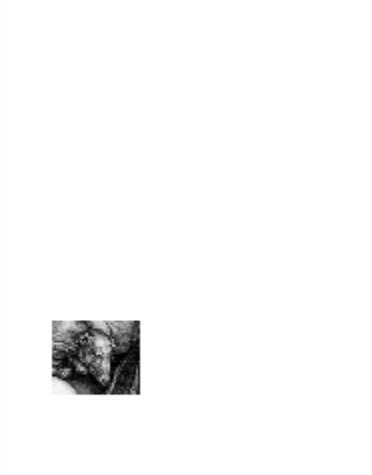

Use `xcorr2` to find where the small image fits in the larger image. Subtract the mean value so that there are roughly equal numbers of negative and positive values.

```
nimg = img-mean(mean(img));  
nSec = nimg(szx,szy);
```

```
crr = xcorr2(nimg,nSec);
```

The maximum of the cross-correlation corresponds to the estimated location of the lower-right corner of the section. Use `ind2sub` to convert the one-dimensional location of the maximum to two-dimensional coordinates.

```
[ssr,snd] = max(crr(:));  
[ij,ji] = ind2sub(size(crr),snd);
```

```

figure
plot(crr(:))
title('Cross-Correlation')
hold on
plot(snd,ssr,'or')
hold off
text(snd*1.05,ssr,'Maximum')

```

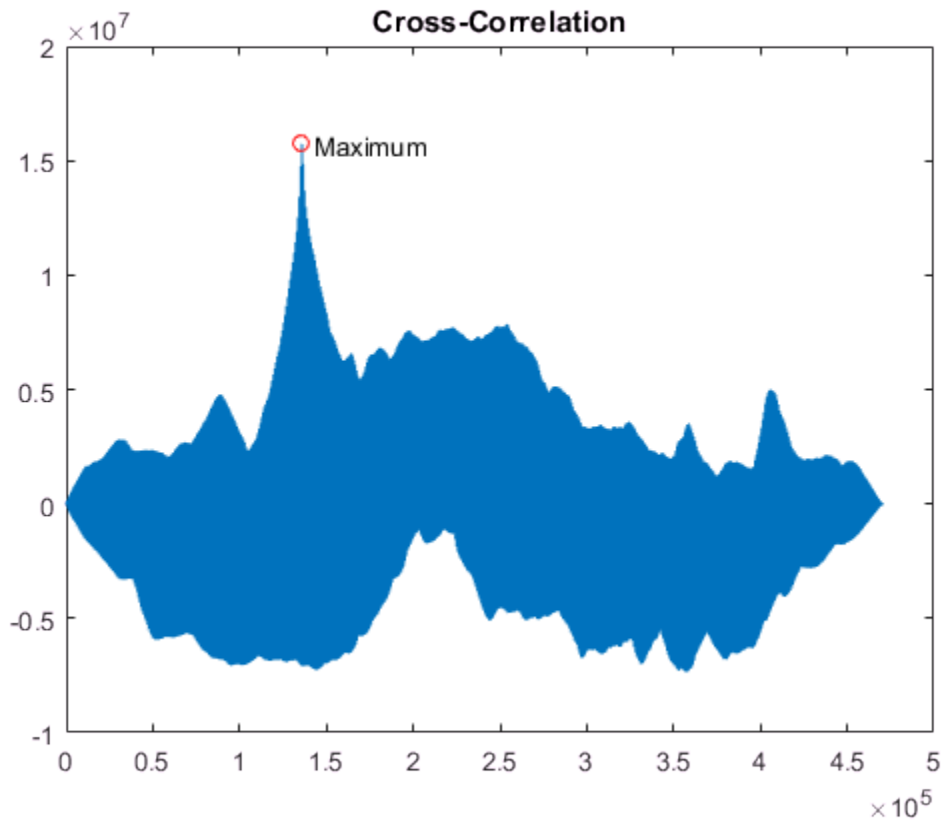

Place the smaller image inside the larger image. Rotate the smaller image to comply with the convention that MATLAB® uses to display images. Draw a rectangle around it.

```
img(ij:-1:ij-size(Sect,1)+1,ji:-1:ji-size(Sect,2)+1) = rot90(Sect,2);
```

```
imagesc(img)
axis image off
colormap gray
title('Reconstructed')
hold on
plot([y y Y Y y],[x X X x x], 'r')
hold off
```

Reconstructed

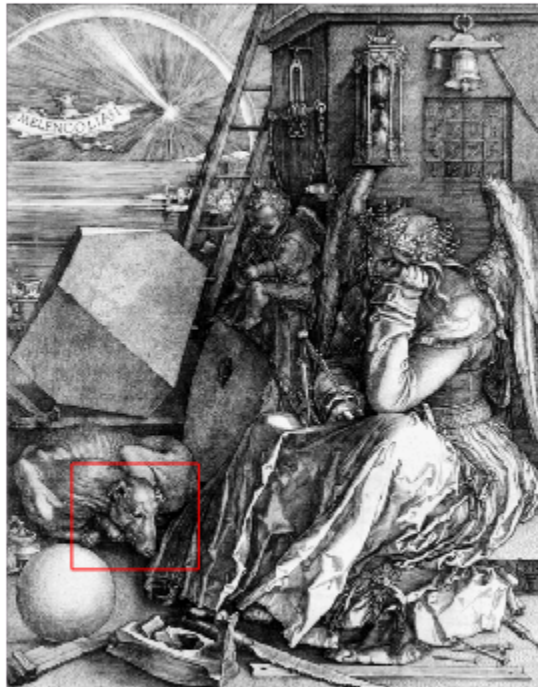

Recovery of Template Shift with Cross-Correlation

Shift a template by a known amount and recover the shift using cross-correlation.

Create a template in an 11-by-11 matrix. Create a 22-by-22 matrix and shift the original template by 8 along the row dimension and 6 along the column dimension.

```
template = 0.2*ones(11);  
template(6,3:9) = 0.6;  
template(3:9,6) = 0.6;  
offsetTemplate = 0.2*ones(22);  
offset = [8 6];  
offsetTemplate((1:size(template,1))+offset(1), ...  
              (1:size(template,2))+offset(2)) = template;
```

Plot the original and shifted templates.

```
imagesc(offsetTemplate)  
colormap gray  
hold on  
imagesc(template)  
axis equal
```

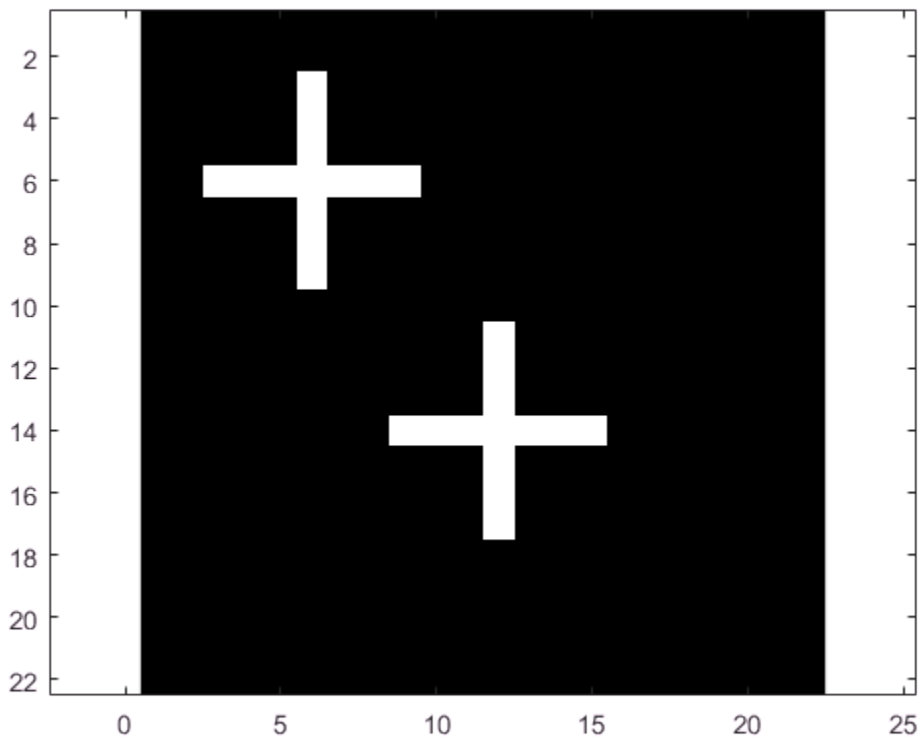

Cross-correlate the two matrices and find the maximum absolute value of the cross-correlation. Use the position of the maximum absolute value to determine the shift in the template. Check the result against the known shift.

```
cc = xcorr2(offsetTemplate,template);
[max_cc, imax] = max(abs(cc(:)));
[ypeak, xpeak] = ind2sub(size(cc),imax(1));
corr_offset = [(ypeak-size(template,1)) (xpeak-size(template,2))];

isequal(corr_offset,offset)

ans = logical
     1
```

The shift obtained from the cross-correlation equals the known template shift in the row and column dimensions.

GPU Acceleration for Cross-Correlation Matrix Computation

This example requires Parallel Computing Toolbox software and a CUDA-enabled NVIDIA GPU with compute capability 1.3 or above.

Shift a template by a known amount and recover the shift using cross-correlation.

Create a template in an 11-by-11 matrix. Create a 22-by-22 matrix and shift the original template by 8 along the row dimension and 6 along the column dimension.

```
template = 0.2*ones(11);
template(6,3:9) = 0.6;
template(3:9,6) = 0.6;
offsetTemplate = 0.2*ones(22);
offset = [8 6];
offsetTemplate((1:size(template,1))+offset(1),...
              (1:size(template,2))+offset(2)) = template;
```

Put the original and shifted template matrices on your GPU using `gpuArray` objects.

```
template = gpuArray(template);
offsetTemplate = gpuArray(offsetTemplate);
```

Compute the cross-correlation on the GPU.

```
cc = xcorr2(offsetTemplate,template);
```

Return the result to the MATLAB workspace using `gather`. Use the maximum absolute value of the cross-correlation to determine the shift, and compare the result with the known shift.

```
cc = gather(cc);
[max_cc, imax] = max(abs(cc(:)));
[ypeak, xpeak] = ind2sub(size(cc),imax(1));
corr_offset = [ (ypeak-size(template,1)) (xpeak-size(template,2)) ];
isequal(corr_offset,offset)
```

Definitions

2-D Cross-Correlation

The 2-D cross-correlation of an M -by- N matrix, X , and a P -by- Q matrix, H , is a matrix, C , of size $M+P-1$ by $N+Q-1$. Its elements are given by

$$C(k,l) = \sum_{m=0}^{M-1} \sum_{n=0}^{N-1} X(m,n) \bar{H}(m-k,n-l), \quad \begin{array}{l} -(P-1) \leq k \leq M-1, \\ -(Q-1) \leq l \leq N-1, \end{array}$$

where the bar over H denotes complex conjugation.

The output matrix, $C(k,l)$, has negative and positive row and column indices.

- A negative row index corresponds to an upward shift of the rows of H .
- A negative column index corresponds to a leftward shift of the columns of H .
- A positive row index corresponds to a downward shift of the rows of H .
- A positive column index corresponds to a rightward shift of the columns of H .

To cast the indices in MATLAB form, add the size of H : the element $C(k,l)$ corresponds to $C(k+P,l+Q)$ in the workspace.

For example, consider this 2-D cross-correlation:

```
X = ones(2,3);
H = [1 2; 3 4; 5 6]; % H is 3 by 2
C = xcorr2(X,H)
```

```
C =
```

6	11	11	5
10	18	18	8
6	10	10	4
2	3	3	1

The $C(1, 1)$ element in the output corresponds to $C(1-3, 1-2) = C(-2, -1)$ in the defining equation, which uses zero-based indexing. To compute the $C(1, 1)$ element, shift H two rows up and one column to the left. Accordingly, the only product in the cross-correlation sum is $X(1, 1) * H(3, 2) = 6$. Using the defining equation, you obtain

$$C(-2, -1) = \sum_{m=0}^1 \sum_{n=0}^2 X(m, n) \bar{H}(m+2, n+1) = X(0, 0) \bar{H}(2, 1) = 1 \times 6 = 6,$$

with all other terms in the double sum equal to zero.

Extended Capabilities

C/C++ Code Generation

Generate C and C++ code using MATLAB® Coder™.

See Also

See Also

[conv2](#) | [filter2](#) | [xcorr](#)

Introduced before R2006a

xcov

Cross-covariance

Syntax

```
c = xcov(x,y)
c = xcov(x)
```

```
c = xcov( ____,maxlag)
c = xcov( ____,scaleopt)
```

```
[c,lags] = xcov( ____)
```

Description

`c = xcov(x,y)` returns the cross-covariance of two discrete-time sequences, `x` and `y`. Cross-covariance measures the similarity between `x` and shifted (lagged) copies of `y` as a function of the lag. If `x` and `y` have different lengths, the function appends zeros at the end of the shorter vector so it has the same length as the other.

`c = xcov(x)` returns the autocovariance sequence of `x`. If `x` is a matrix, then `c` is a matrix whose columns contain the autocovariance and cross-covariance sequences for all combinations of the columns of `x`.

`c = xcov(____,maxlag)` limits the lag range from `-maxlag` to `maxlag`. This syntax accepts one or two input sequences. `maxlag` defaults to $N - 1$.

`c = xcov(____,scaleopt)` additionally specifies a normalization option for the cross-covariance or autocovariance. Any option other than `'none'` (the default) requires `x` and `y` to have the same length.

`[c,lags] = xcov(____)` also outputs a vector with the lags at which the covariances are computed.

Examples

Cross-Covariance of Two Shifted Signals

Create s , a two-channel 150-sample signal consisting of s_1 , a uniform random sequence, and s_2 , a copy of s_1 shifted circularly by 50 samples. Reset the random number generator for reproducible results. Plot the sequences.

```
rng default
shft = 50;

s1 = rand(150,1);
s2 = circshift(s1,[shft 0]);
s = [s1 s2];

subplot(2,1,1)
plot(s1)
title('s_1')
subplot(2,1,2)
plot(s2)
title('s_2')
hold on
plot([shft shft],[0 1])
```

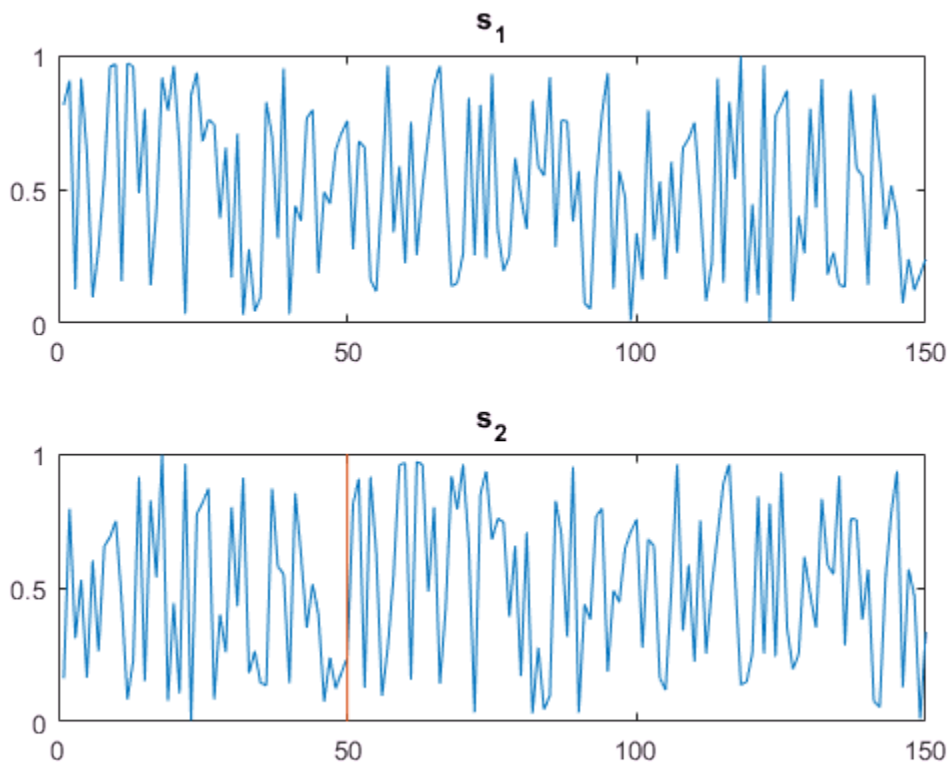

Compute biased estimates of the autocovariance and mutual cross-covariance sequences.

The output array is organized as $\text{texttt{c}} = (c_{s_1 s_1} \quad c_{s_1 s_2} \quad c_{s_2 s_1} \quad c_{s_2 s_2})$. Plot the result. The maxima at ∓ 50 and ± 100 are a result of the circular shift.

```
[c,lg] = xcov(s,'biased');
```

```
figure
plot(lg,c)
legend('c_{s_1s_1}','c_{s_1s_2}','c_{s_2s_1}','c_{s_2s_2}')
```

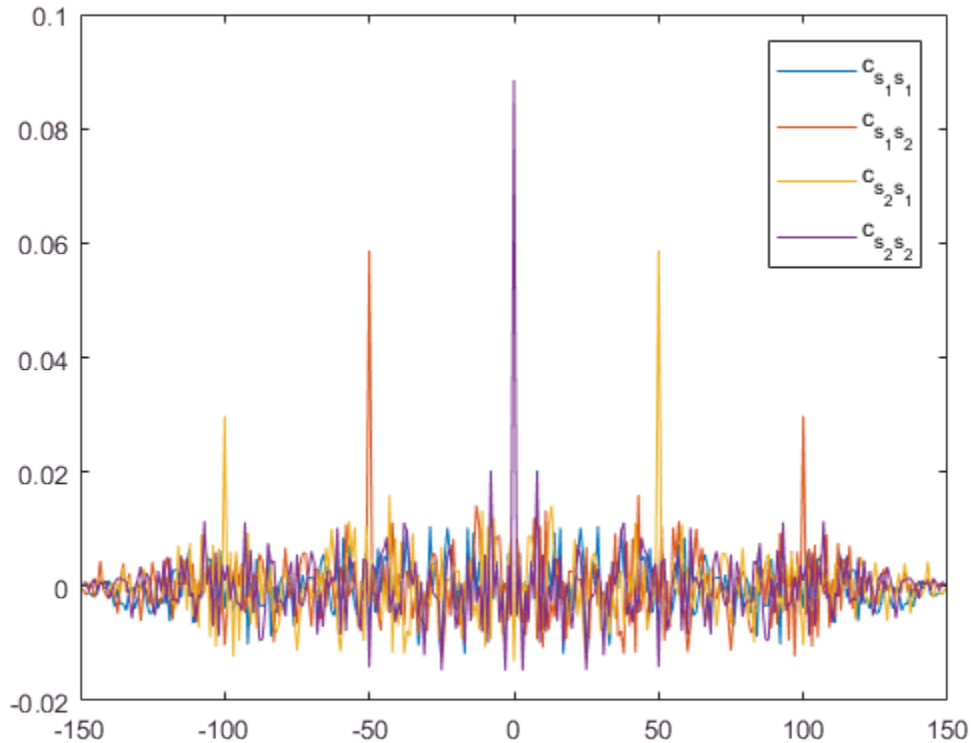

Change the normalization so that the autocovariance sequences are unity at zero lag. Plot each sequence in its own subplot.

```
[c,lg] = xcov(s, 'coeff');

for a = 1:2
    for b = 1:2
        nm = 2*(a-1)+b;
        subplot(2,2,nm)
        plot(lg,c(:,nm))
        title(sprintf('c_{s_%ds_%d}',a,b))
        axis([-150 150 -0.2 1])
    end
end
```

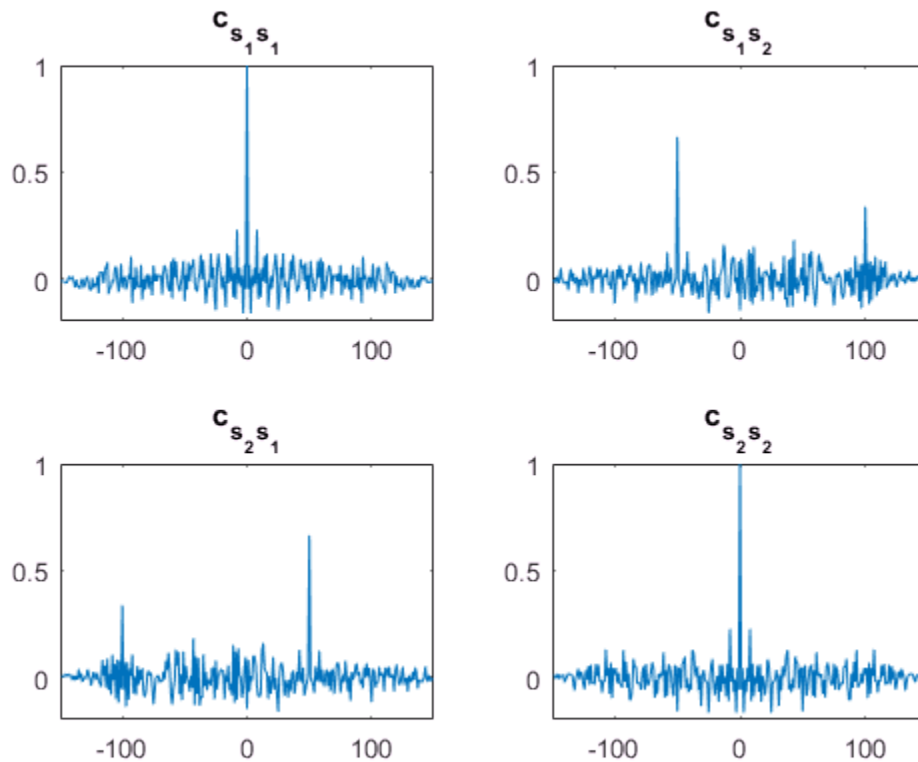

Autocovariance of White Gaussian Noise

Display the estimated autocovariance of white Gaussian noise, $c_{ww}(m)$, for $-10 \leq m \leq 10$. Reset the random number generator for reproducible results. Normalize the sequence so that it is unity at zero lag.

```
rng default
```

```
ww = randn(1000,1);
[cov_ww,lags] = xcov(ww,10,'coeff');
```

```
stem(lags,cov_ww)
```

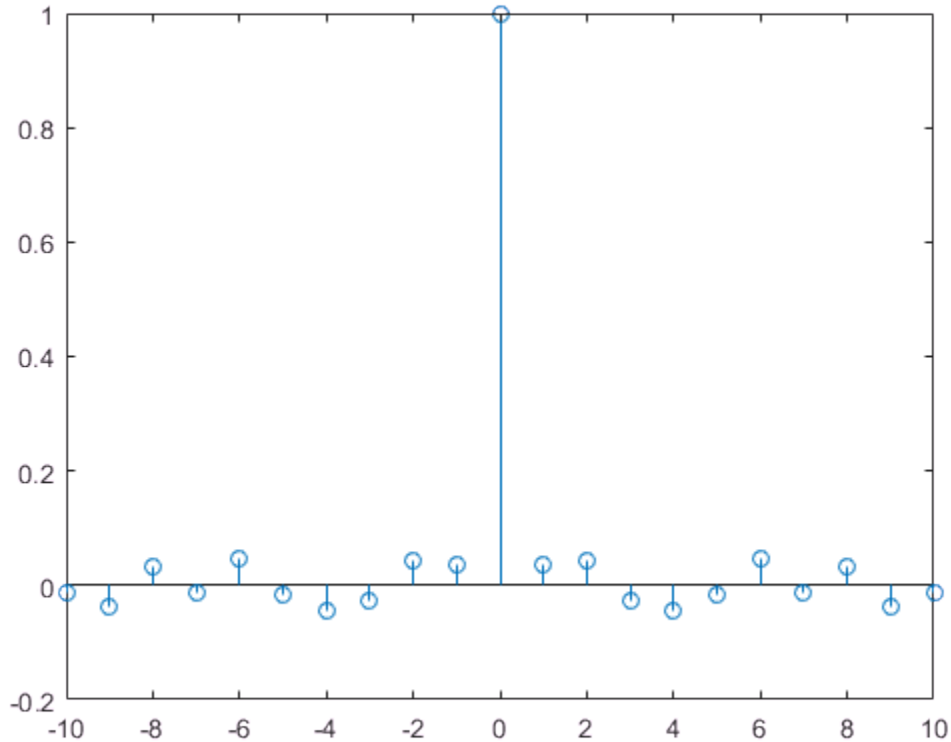

GPU Acceleration for Autocovariance Sequence Estimation

This example requires Parallel Computing Toolbox software and a CUDA-enabled NVIDIA GPU with compute capability 1.3 or above. See GPU System Requirements for details.

Create a signal consisting of a 10 Hz sine wave in additive noise, sampled at 1 kHz. Use `gpuArray` to create a `gpuArray` object stored on your computer's GPU.

```
t = 0:0.001:10-0.001;  
x = cos(2*pi*10*t) + randn(size(t));
```

```
X = gpuArray(x);
```

Compute the autocovariance sequence to lag 200.

```
[xc,lags] = xcov(X,200);
```

The output, `xc`, is a `gpuArray` object.

Use `gather` to transfer the data from the GPU to the MATLAB workspace as a double-precision vector.

```
xc = gather(xc);
```

- “Measuring Signal Similarities”
- “Accelerating Correlation with GPUs”

Input Arguments

x — Input array

vector | matrix | `gpuArray` object

Input array, specified as a vector, a matrix, or a `gpuArray` object.

See “GPU Computing” (Parallel Computing Toolbox) and GPU System Requirements for details on using `xcov` with `gpuArray` objects.

Example: `sin(2*pi*(0:9)/10) + randn([1 10])/10` specifies a noisy sinusoid as a row vector.

Example: `sin(2*pi*[0.1;0.3]*(0:39))' + randn([40 2])/10` specifies a two-channel noisy sinusoid.

Example: `gpuArray(sin(2*pi*(0:9)/10) + randn([1 10])/10)` specifies a noisy sinusoid as a `gpuArray` object.

Data Types: `single` | `double`

Complex Number Support: Yes

y — Input array

vector | `gpuArray` object

Input array, specified as a vector or a `gpuArray` object.

Data Types: `single` | `double`
Complex Number Support: Yes

maxlag — Maximum lag

integer scalar

Maximum lag, specified as an integer scalar. If you specify `maxlag`, the returned cross-covariance sequence ranges from $-\text{maxlag}$ to maxlag . If you do not specify `maxlag`, the lag range equals $2N - 1$, where N is the greater of the lengths of x and y .

Data Types: `single` | `double`

scaleopt — Normalization option

'none' (default) | 'biased' | 'unbiased' | 'coeff'

Normalization option, specified as one of the following:

- 'none' — Raw, unscaled cross-covariance. This is the only allowed option when x and y have different lengths.
- 'biased' — Biased estimate of the cross-covariance.
- 'unbiased' — Unbiased estimate of the cross-covariance.
- 'coeff' — Normalizes the sequence so that the autocovariances at zero lag equal 1.

Data Types: `char`

Output Arguments

c — Cross-covariance or autocovariance sequence

vector | matrix | `gpuArray` object

Cross-covariance or autocovariance sequence, returned as a vector, a matrix, or a `gpuArray` object.

If x is an $M \times N$ signal matrix representing N channels in its columns, then `xcov(x)` returns a $(2M - 1) \times N^2$ matrix with the autocovariances and mutual cross-covariances of the channels of x . If you specify `maxlag`, then c has size $(2 \times \text{maxlag} - 1) \times N^2$.

For example, if S is a three-channel signal, $S = (x_1 \ x_2 \ x_3)$, then the result of $C = \text{xcov}(S)$ is organized as

$$\mathbf{c} = \left(c_{x_1x_1} \quad c_{x_1x_2} \quad c_{x_1x_3} \quad c_{x_2x_1} \quad c_{x_2x_2} \quad c_{x_2x_3} \quad c_{x_3x_1} \quad c_{x_3x_2} \quad c_{x_3x_3} \right).$$

Lags — Lag indices

vector

Lag indices, returned as a vector.

Definitions

Cross-Covariance and Autocovariance

`xCOV` computes the mean of its inputs, subtracts the mean, and then calls `xcorr`. `xCOV` does not check for any errors other than the correct number of input arguments. Instead, it relies on the error checking in `xcorr`.

The result of `xCOV` can be interpreted as an estimate of the covariance between two random sequences or as the deterministic covariance between two deterministic signals.

The true cross-covariance sequence of two jointly stationary random processes, x_n and y_n , is the cross-correlation of mean-removed sequences,

$$\phi_{xy}(m) = E\{(x_{n+m} - \mu_x)(y_n - \mu_y)^*\},$$

where μ_x and μ_y are the mean values of the two stationary random processes, the asterisk denotes complex conjugation, and E is the expected value operator. `xCOV` can only estimate the sequence because, in practice, only a finite segment of one realization of the infinite-length random process is available.

By default, `xCOV` computes raw covariances with no normalization:

$$c_{xy}(m) = \begin{cases} \sum_{n=0}^{N-m-1} \left(x_{n+m} - \frac{1}{N} \sum_{i=0}^{N-1} x_i \right) \left(y_n^* - \frac{1}{N} \sum_{i=0}^{N-1} y_i^* \right), & m \geq 0, \\ c_{yx}^*(-m), & m < 0. \end{cases}$$

The output vector, `c`, has elements given by

$$c(m) = c_{xy}(m - N), \quad m = 1, \dots, 2N - 1.$$

The covariance function requires normalization to estimate the function properly. You can control the normalization of the correlation by using the input argument `scaleopt`.

References

- [1] Orfanidis, Sophocles J. *Optimum Signal Processing: An Introduction*. 2nd Edition. New York: McGraw-Hill, 1996.
- [2] Larsen, Jan. “Correlation Functions and Power Spectra.” November, 2009. http://www2.imm.dtu.dk/pubdb/views/edoc_download.php/4932/pdf/imm4932.pdf

Extended Capabilities

C/C++ Code Generation

Generate C and C++ code using MATLAB® Coder™.

See Also

See Also

`conv` | `corrcoef` | `cov` | `gather` | `gpuArray` | `xcorr` | `xcorr2`

Topics

“Measuring Signal Similarities”

“Accelerating Correlation with GPUs”

Introduced before R2006a

xspectrogram

Cross-spectrogram using short-time Fourier transforms

Syntax

```
s = xspectrogram(x,y)
s = xspectrogram(x,y>window)
s = xspectrogram(x,y>window,noverlap)
s = xspectrogram(x,y>window,noverlap,nfft)

[s,w,t] = xspectrogram( ___ )
[s,f,t] = xspectrogram( ___ ,fs)

[s,w,t] = xspectrogram(x,y>window,noverlap,w)
[s,f,t] = xspectrogram(x,y>window,noverlap,f,fs)

[ ___ ,c] = xspectrogram( ___ )

[ ___ ] = xspectrogram( ___ ,freqrange)
[ ___ ] = xspectrogram( ___ ,spectrumtype)
[ ___ ] = xspectrogram( ___ , 'MinThreshold', thresh)

xspectrogram( ___ )
xspectrogram( ___ ,freqloc)
```

Description

`s = xspectrogram(x,y)` returns the cross-spectrogram of the signals specified by `x` and `y`. The input signals must be vectors with the same number of elements. Each column of `s` contains an estimate of the short-term, time localized frequency content common to `x` and `y`.

`s = xspectrogram(x,y>window)` uses `window` to divide `x` and `y` into segments and perform windowing.

`s = xspectrogram(x,y>window,noverlap)` uses `noverlap` samples of overlap between adjoining segments.

`s = xspectrogram(x,y>window,noverlap,nfft)` uses `nfft` sampling points to calculate the discrete Fourier transform.

`[s,w,t] = xspectrogram(___)` returns a vector of normalized frequencies, `w`, and a vector of time instants, `t`, at which the cross-spectrogram is computed. This syntax can include any combination of input arguments from previous syntaxes.

`[s,f,t] = xspectrogram(___,fs)` returns a vector of frequencies, `f`, expressed in terms of `fs`, the sample rate. `fs` must be the sixth input to `xspectrogram`. To input a sample rate and still use the default values of the preceding optional arguments, specify these arguments as empty, `[]`.

`[s,w,t] = xspectrogram(x,y>window,noverlap,w)` returns the cross-spectrogram at the normalized frequencies specified in `w`.

`[s,f,t] = xspectrogram(x,y>window,noverlap,f,fs)` returns the cross-spectrogram at the frequencies specified in `f`.

`[___,c] = xspectrogram(___)` also returns a matrix, `c`, containing an estimate of the time-varying complex cross-spectrum of the input signals. The cross-spectrogram, `s`, is the magnitude of `c`.

`[___] = xspectrogram(___,freqrange)` returns the cross-spectrogram over the frequency range specified by `freqrange`. Valid options for `freqrange` are `'onesided'`, `'twosided'`, and `'centered'`.

`[___] = xspectrogram(___,spectrumtype)` returns short-term cross power spectral density estimates if `spectrumtype` is specified as `'psd'` and returns short-term cross power spectrum estimates if `spectrumtype` is specified as `'power'`.

`[___] = xspectrogram(___, 'MinThreshold', thresh)` sets to zero those elements of `s` such that $10 \log_{10}(s) \leq \text{thresh}$. Specify `thresh` in decibels.

`xspectrogram(___)` with no output arguments plots the cross-spectrogram in the current figure window.

`xspectrogram(___,freqloc)` specifies the axis on which to plot the frequency. Specify `freqloc` as either `'xaxis'` or `'yaxis'`.

Examples

Cross-Spectrogram of Linear Chirps

Generate two linear chirps sampled at 1 MHz for 10 milliseconds.

- The first chirp has an initial frequency of 150 kHz that increases to 350 kHz by the end of the measurement.
- The second chirp has an initial frequency of 200 kHz that increases to 300 kHz by the end of the measurement.

Add white Gaussian noise such that the signal-to-noise ratio is 40 dB.

```
nSamp = 10000;
Fs = 1000e3;
SNR = 40;
t = (0:nSamp-1)'/Fs;

x1 = chirp(t,150e3,t(end),350e3);
x1 = x1+randn(size(x1))*std(x1)/db2mag(SNR);

x2 = chirp(t,200e3,t(end),300e3);
x2 = x2+randn(size(x2))*std(x2)/db2mag(SNR);
```

Compute and plot the cross-spectrogram of the two chirps. Divide the signals into 200-sample segments and window each segment with a Hamming window. Specify 80 samples of overlap between adjoining segments and a DFT length of 1024 samples.

```
xspectrogram(x1,x2,hamming(200),80,1024,Fs,'yaxis')
```

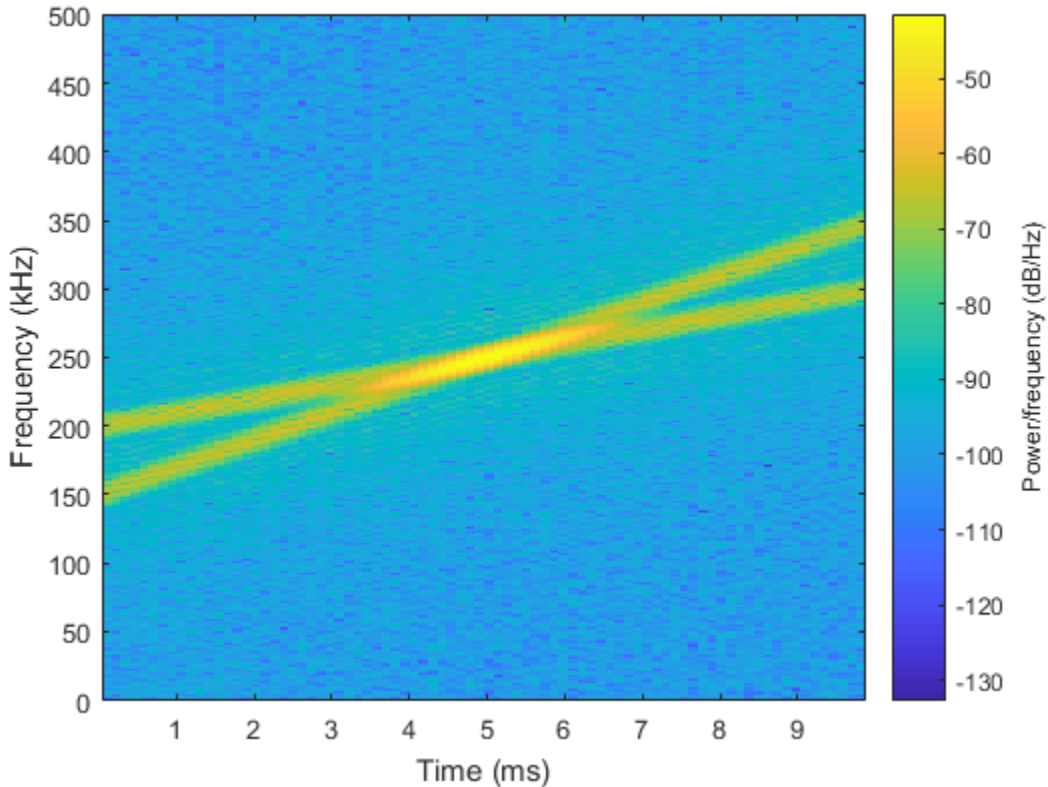

Modify the second chirp so that the frequency rises from 50 kHz to 350 kHz during the measurement. Use a 500-sample Kaiser window with shape factor $\beta = 5$ to window the segments. Specify 450 samples of overlap and a DFT length of 256. Compute and plot the cross-spectrogram.

```
x2 = chirp(t,50e3,t(end),350e3);
x2 = x2+randn(size(x2))*std(x2)/db2mag(SNR);

xspectrogram(x1,x2,kaiser(500,5),450,256,Fs,'yaxis')
```

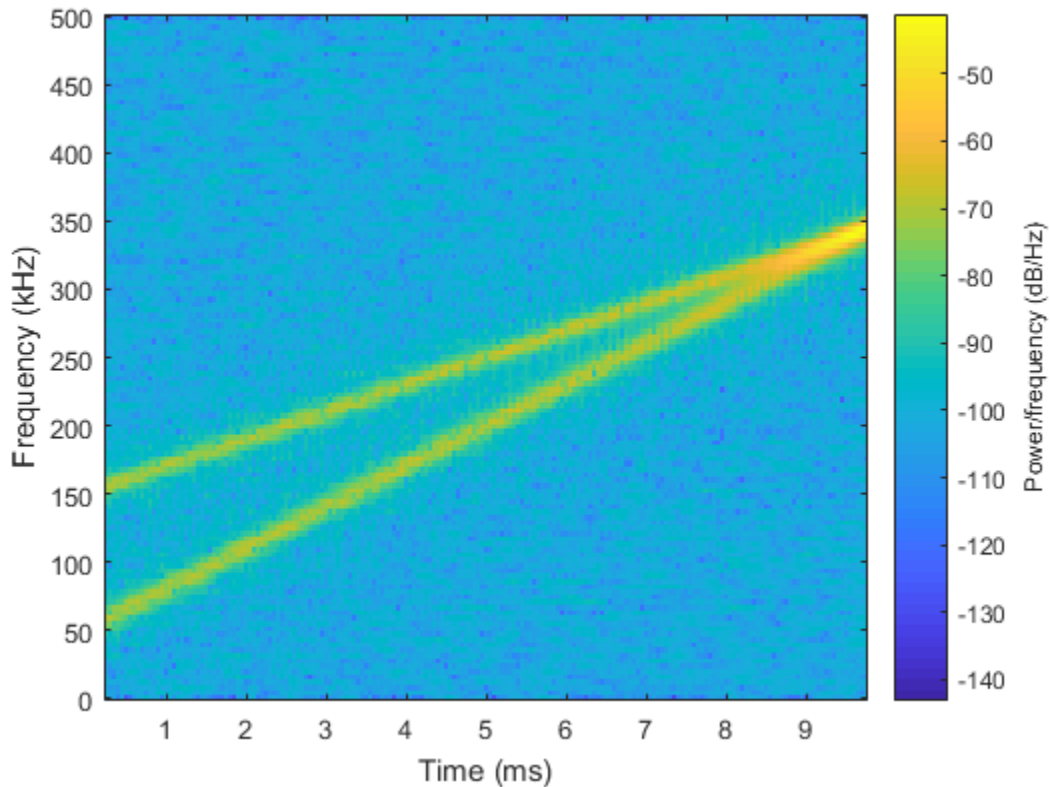

In both cases, the function highlights the frequency content that the two signals have in common.

Cross-Spectrogram of Speech Signals

Load a file containing two speech signals sampled at 44,100 Hz.

- The first signal is a recording of a female voice saying "transform function."
- The second signal is a recording of the same female voice saying "reform justice."

Plot the two signals. Offset the second signal vertically so both are visible.

```
load(fullfile(matlabroot, 'examples', 'signal', 'voice.mat'))
```

```
% To hear, type soundsc(transform,fs),pause(2),soundsc(reform,fs)

t = (0:length(reform)-1)/fs;

plot(t,transform,t,reform+0.3)
legend('Transform function','Reform justice')
```

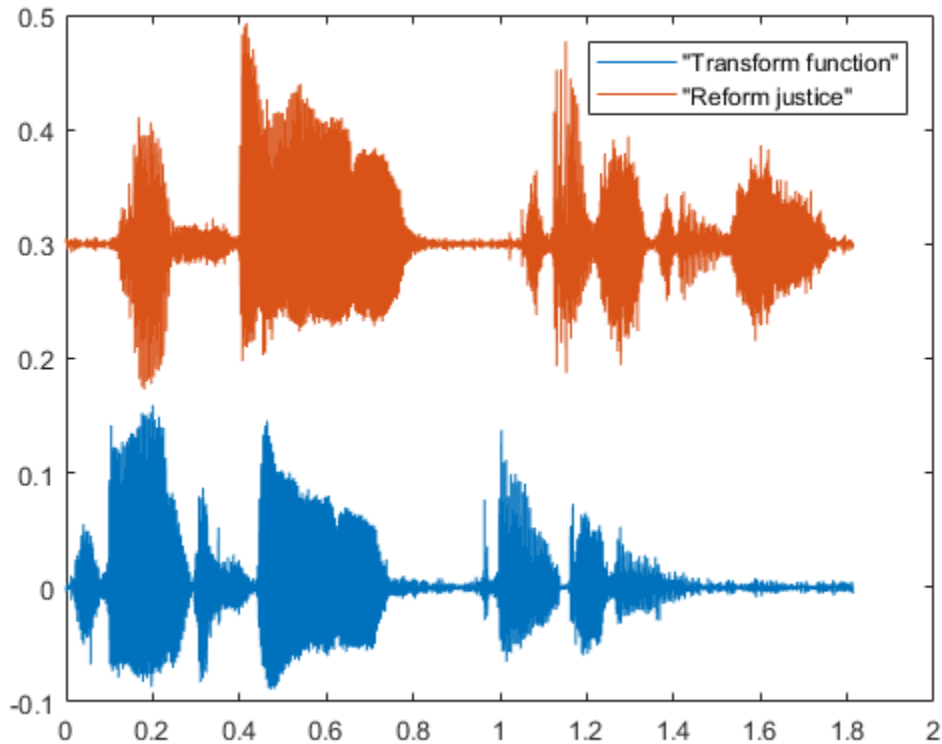

Compute the cross-spectrogram of the two signals. Divide the signals into 1000-sample segments and window them with a Hamming window. Specify 800 samples of overlap between adjoining segments. Include only frequencies up to 4 kHz.

```
nwin = 1000;
nvlp = 800;
fint = 0:4000;
```



```
[s,f,t] = xspectrogram(transform,reform,hamming(nwin),nvlp,fint,fs);  
mesh(t,f,20*log10(s))  
view(2)  
axis tight
```

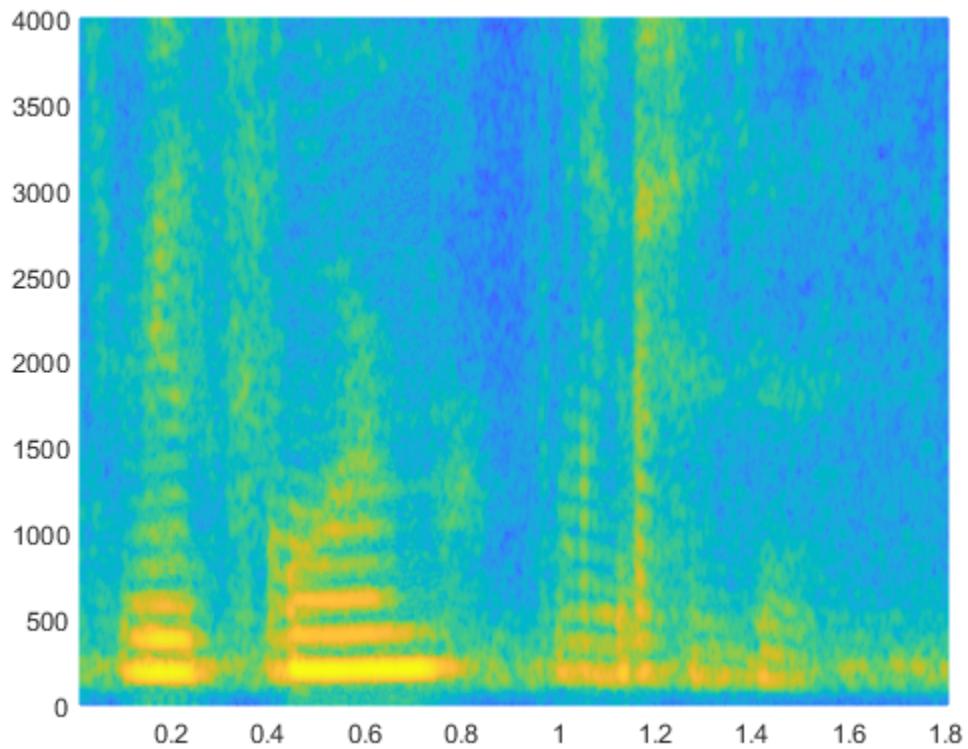

The cross-spectrogram highlights the time intervals where the signals have more frequency content in common. The syllable "form" is particularly noticeable.

Phase Shift Between Two Quadratic Chirps

Generate two quadratic chirps, each sampled at 1 kHz for 2 seconds. Both chirps have an initial frequency of 100 Hz that increases to 200 Hz midway through the measurement. The second chirp has a phase difference of 23° compared to the first.

```
fs = 1e3;  
t = 0:1/fs:2;  
  
y1 = chirp(t,100,1,200,'quadratic',0);  
y2 = chirp(t,100,1,200,'quadratic',23);
```

Compute the complex cross-spectrogram of the chirps to extract the phase shift between them. Divide the signals into 128-sample segments. Specify 120 samples of overlap between adjoining segments. Window each segment using a Kaiser window with shape factor $\beta = 18$ and specify a DFT length of 128 samples. Use the plotting functionality of `xspectrogram` to display the cross-spectrogram.

```
[~,f,xt,c] = xspectrogram(y1,y2,kaiser(128,18),120,128,fs);  
xspectrogram(y1,y2,kaiser(128,18),120,128,fs,'yaxis')
```

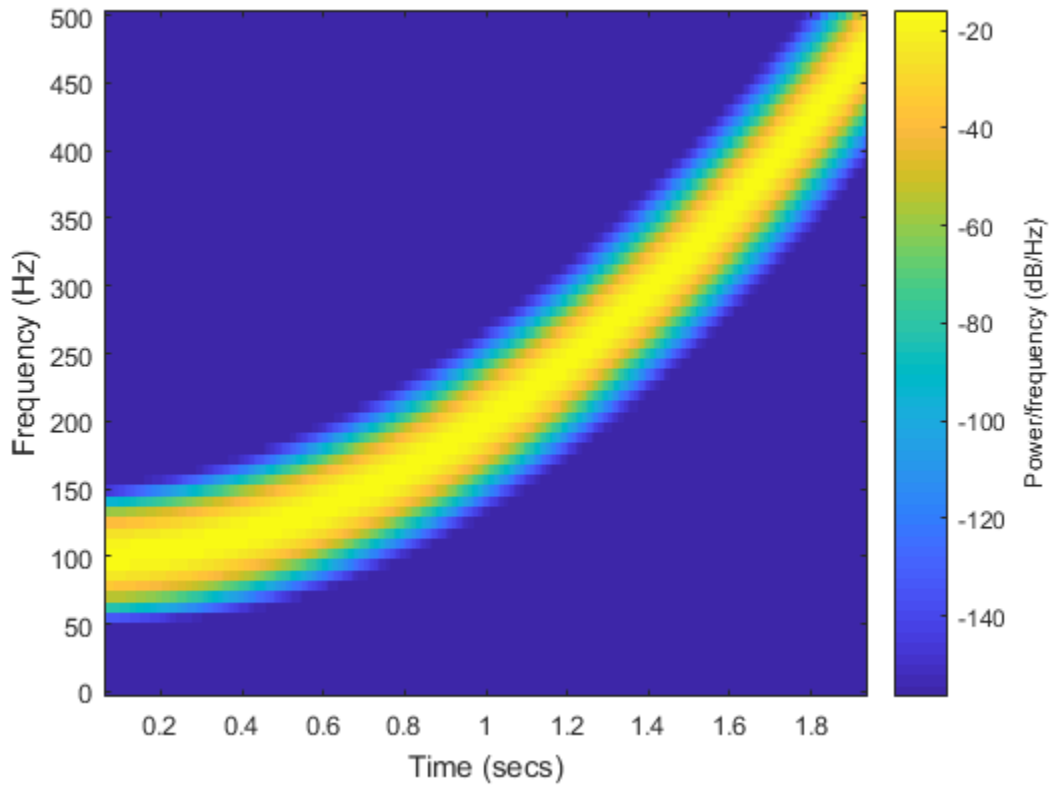

Extract and display the maximum-energy time-frequency ridge of the cross-spectrogram.

```
[tfr,~,lridge] = tfridge(c,f);
```

```
hold on  
plot(xt,tfr,'k','linewidth',2)  
hold off
```

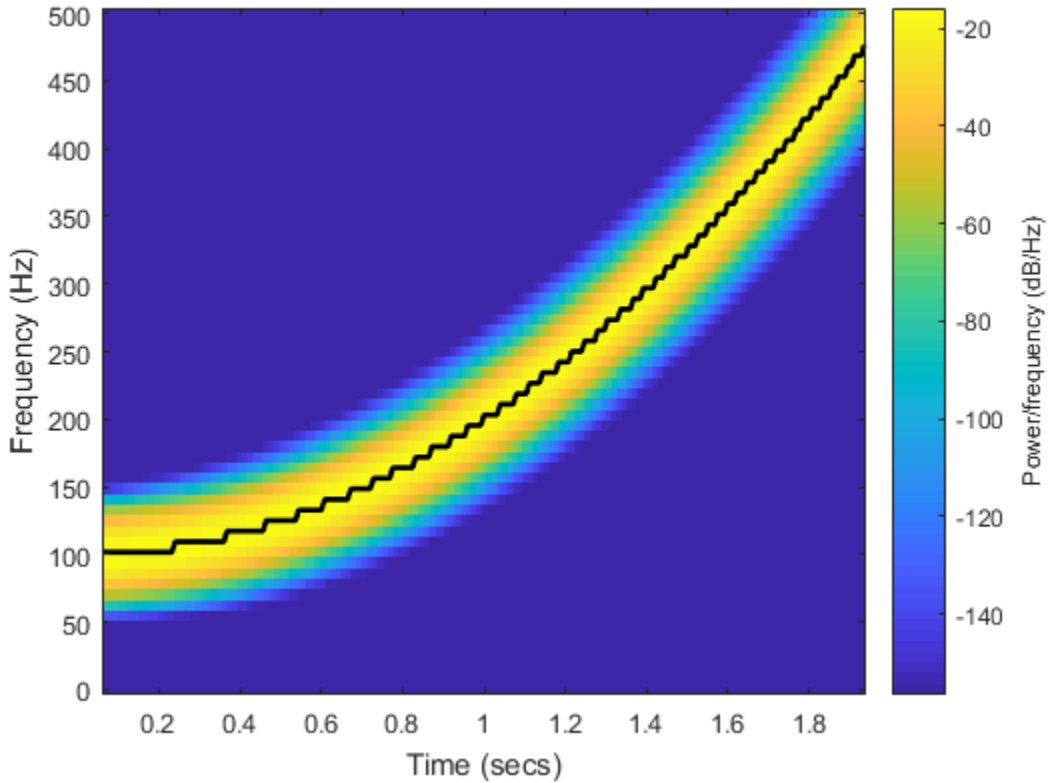

The phase shift is the ratio of imaginary part to real part of the time-varying cross-spectrum along the ridge. Compute the phase shift and express it in degrees. Display its mean value.

```
pshft = angle(c(lridge))*180/pi;
```

```
mean(pshft)
```

```
ans =
```

```
-23.0000
```

Cross-Spectrogram of Complex Signals

Generate two signals, each sampled at 3 kHz for 1 second. The first signal is a quadratic chirp whose frequency increases from 300 Hz to 1300 Hz during the measurement. The chirp is embedded in white Gaussian noise. The second signal, also embedded in white noise, is a chirp with sinusoidally varying frequency content.

```
fs = 3000;  
t = 0:1/fs:1-1/fs;  
  
x1 = chirp(t,300,t(end),1300,'quadratic')+randn(size(t))/100;  
  
x2 = exp(2j*pi*100*cos(2*pi*2*t))+randn(size(t))/100;
```

Compute and plot the cross-spectrogram of the two signals. Divide the signals into 256-sample segments with 255 samples of overlap between adjoining segments. Use a Kaiser window with shape factor $\beta = 30$ to window the segments. Use the default number of DFT points. Center the cross-spectrogram at zero frequency.

```
nwin = 256;  
  
xspectrogram(x1,x2,kaiser(nwin,30),nwin-1,[],fs,'centered','yaxis')
```

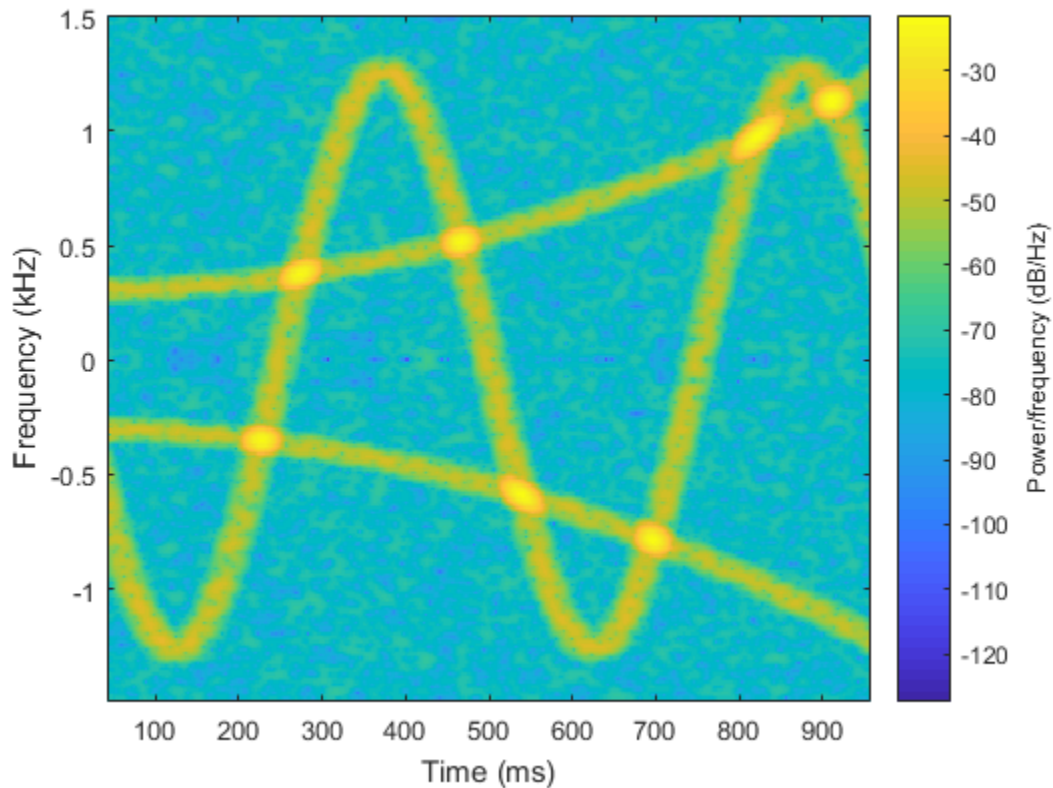

Compute the power spectrum instead of the power spectral density. Set to zero the values smaller than -40 dB. Center the plot at the Nyquist frequency.

```
xspectrogram(x1,x2,kaiser(nwin,30),nwin-1,[],fs, ...  
             'power','MinThreshold',-40,'yaxis')  
title('Cross-Spectrogram of Quadratic Chirp and Complex Chirp')
```

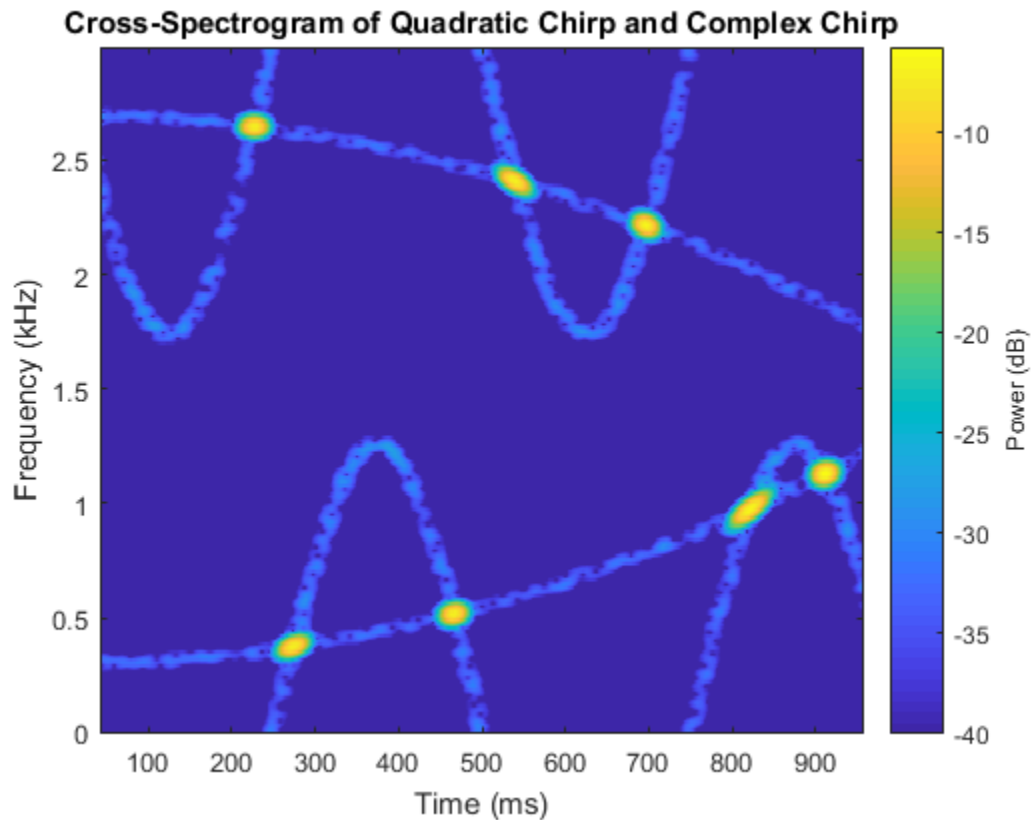

The thresholding further highlights the regions of common frequency.

Cross-Spectrogram of Two Sequences

Compute and plot the cross-spectrogram of two sequences.

Specify each sequence to be 4096 samples long.

```
N = 4096;
```

To create the first sequence, generate a convex quadratic chirp embedded in white Gaussian noise and bandpass filter it.

- The chirp has an initial normalized frequency of 0.1π that increases to 0.8π by the end of the measurement.

- The 16th-order filter passes normalized frequencies between 0.2π and 0.4π rad/sample and has a stopband attenuation of 60 dB.

```
rx = chirp(0:N-1,0.1/2,N,0.8/2,'quadratic',[],'convex')+randn(N,1)/100;
dx = designfilt('bandpassiir','FilterOrder',16, ...
    'StopbandFrequency1',0.2,'StopbandFrequency2',0.4, ...
    'StopbandAttenuation',60);
x = filter(dx,rx);
```

To create the second sequence, generate a linear chirp embedded in white Gaussian noise and bandstop filter it.

- The chirp has an initial normalized frequency of 0.9π that decreases to 0.1π by the end of the measurement.
- The 16th-order filter stops normalized frequencies between 0.6π and 0.8π rad/sample and has a passband ripple of 1 dB.

```
ry = chirp(0:N-1,0.9/2,N,0.1/2)+'randn(N,1)/100;
dy = designfilt('bandstopiir','FilterOrder',16, ...
    'PassbandFrequency1',0.6,'PassbandFrequency2',0.8, ...
    'PassbandRipple',1);
y = filter(dy,ry);
```

Plot the two sequences. Offset the second sequence vertically so both are visible.

```
plot([x y+2])
```

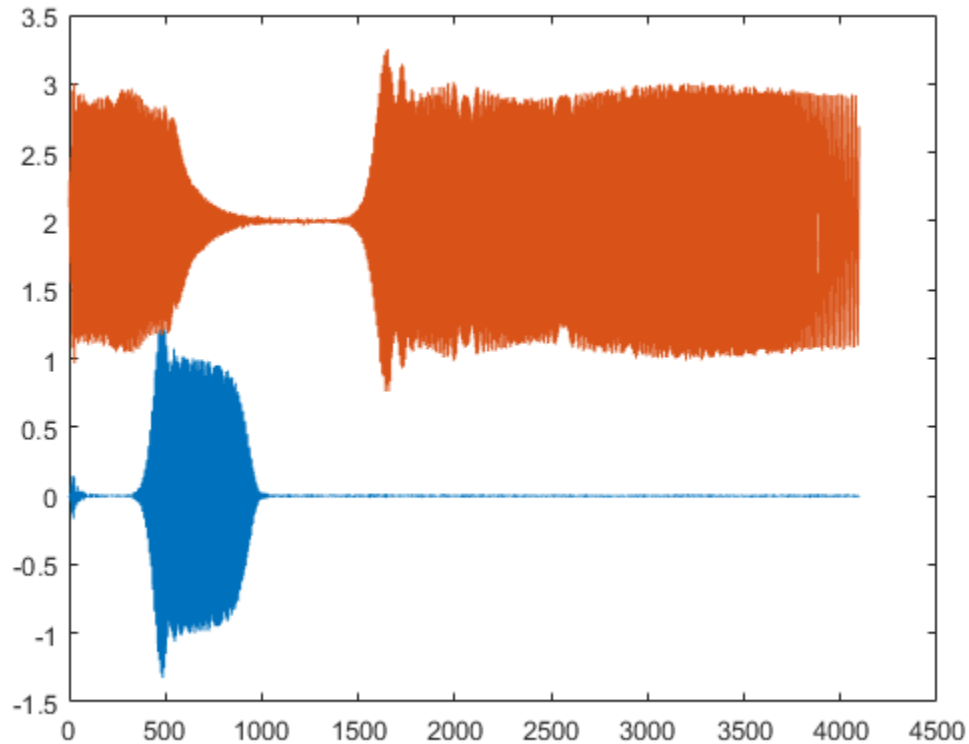
Compute and plot the cross-spectrogram of x and y . Use a 512-sample Hamming window. Specify 500 samples of overlap between adjoining segments and 2048 DFT points.

```
xspectrogram(x,y,hamming(512),500,2048,'yaxis')
```

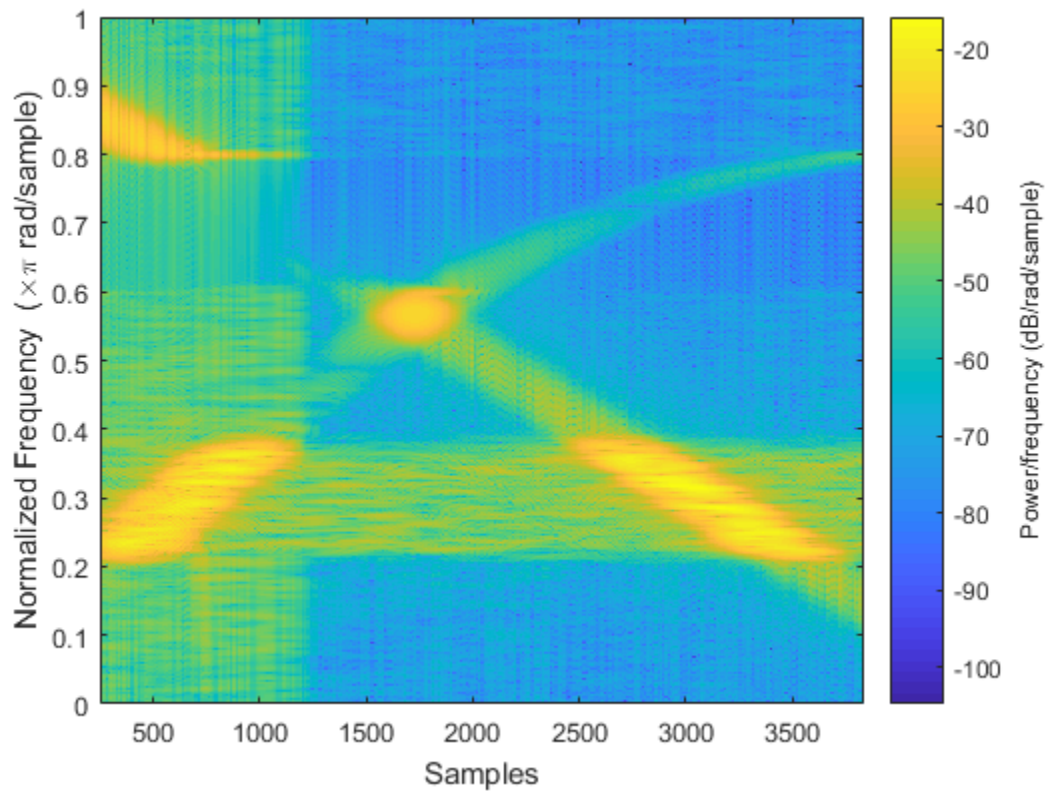

Set to zero the cross-spectrogram values smaller than -50 dB.

```
xspectrogram(x,y,hamming(512),500,2048,'MinThreshold',-50,'yaxis')
```

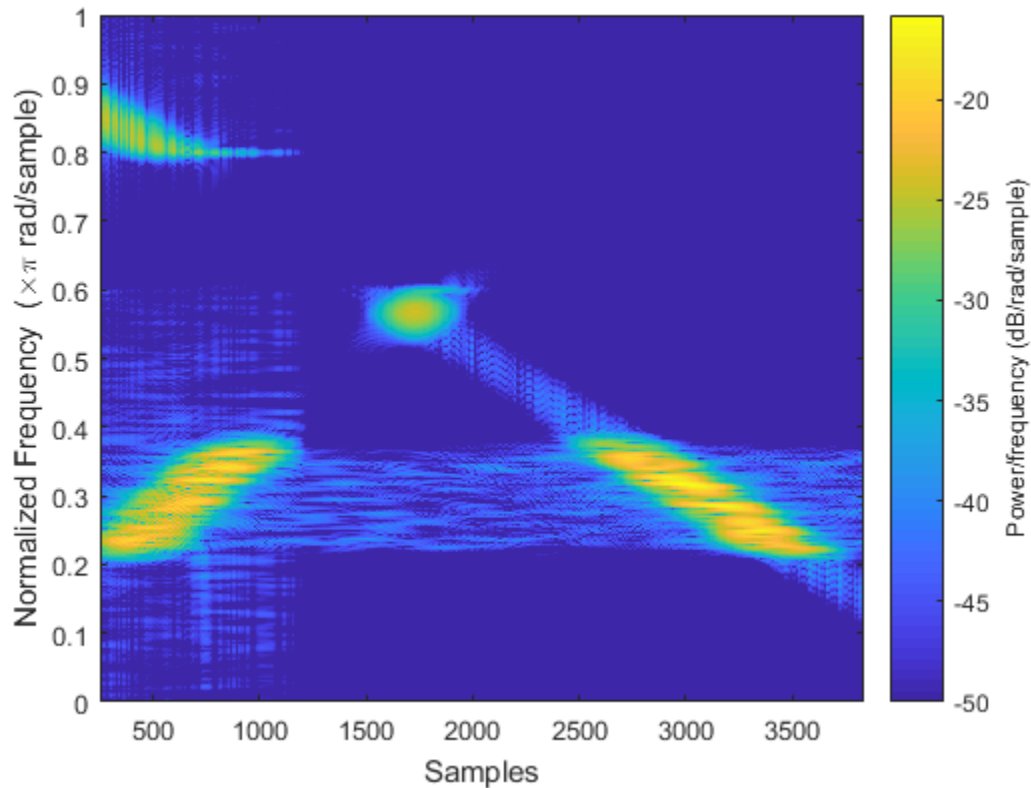

The spectrogram shows the frequency regions that are enhanced or suppressed by the filters.

Input Arguments

x, y — Input signals
vectors

Input signals, specified as vectors.

Example: `cos(pi/4*(0:159))+randn(1,160)` specifies a sinusoid embedded in white Gaussian noise.

Data Types: `single` | `double`

Complex Number Support: Yes

window — Window

`integer` | `vector` | `[]`

Window, specified as an integer or as a row or column vector. Use `window` to divide the signals into segments.

- If `window` is an integer, then `xspectrogram` divides `x` and `y` into segments of length `window` and windows each segment with a Hamming window of that length.
- If `window` is a vector, then `xspectrogram` divides `x` and `y` into segments of the same length as the vector and windows each segment using `window`.

If the input signals cannot be divided exactly into an integer number of segments with `noverlap` overlapping samples, then they are truncated accordingly.

If you specify `window` as empty, then `xspectrogram` uses a Hamming window such that `x` and `y` are divided into eight segments with `noverlap` overlapping samples.

For a list of available windows, see “Windows”.

Example: `hann(N+1)` and `(1 - cos(2*pi*(0:N)'/N))/2` both specify a Hann window of length `N + 1`.

Data Types: `single` | `double`

noverlap — Number of overlapped samples

`positive integer` | `[]`

Number of overlapped samples, specified as a positive integer.

- If `window` is scalar, then `noverlap` must be smaller than `window`.
- If `window` is a vector, then `noverlap` must be smaller than the length of `window`.

If you specify `noverlap` as empty, then `xspectrogram` uses a number that produces 50% overlap between segments. If the segment length is unspecified, the function sets `noverlap` to $\lfloor N/4.5 \rfloor$, where `N` is the length of the input signals.

Data Types: `double` | `single`

nfft — Number of DFT points

`positive integer` | `[]`

Number of DFT points, specified as a positive integer scalar. If you specify `nfft` as empty, then `xspectrogram` sets the DFT length to $\max(256, 2^p)$, where $p = \lceil \log_2 N \rceil$ for input signals of length N .

Data Types: `single` | `double`

w — Normalized frequencies

vector

Normalized frequencies, specified as a vector. `w` must have at least two elements. Normalized frequencies are in rad/sample.

Example: `pi./[2 4]`

Data Types: `double` | `single`

f — Frequencies

vector

Frequencies, specified as a vector. `f` must have at least two elements. The units of `f` are specified by the sample rate, `fs`.

Data Types: `double` | `single`

fs — Sample rate

1 Hz (default) | positive scalar

Sample rate, specified as a positive scalar. The sample rate is the number of samples per unit time. If the unit of time is seconds, then the sample rate is in Hz.

Data Types: `double` | `single`

freqrange — Frequency range for cross-spectrum estimate

'onesided' | 'twosided' | 'centered'

Frequency range for the cross-spectrum estimate, specified as 'onesided', 'twosided', or 'centered'. For real-valued signals, the default is 'onesided'. For complex-valued signals, the default is 'twosided', and specifying 'onesided' results in an error.

- 'onesided' — Returns the one-sided cross-spectrogram of a real input signal. If `nfft` is even, then `s` has $nfft/2 + 1$ rows and is computed over the interval $[0, \pi]$ rad/sample. If `nfft` is odd, then `s` has $(nfft + 1)/2$ rows and the interval is $[0, \pi)$ rad/

sample. If you specify `fs`, then the intervals are respectively $[0, fs/2]$ cycles/unit time and $[0, fs/2)$ cycles/unit time.

- `'twosided'` — Returns the two-sided cross-spectrogram of a real or complex signal. `s` has `nfft` rows and is computed over the interval $[0, 2\pi]$ rad/sample. If you specify `fs`, then the interval is $[0, fs)$ cycles/unit time.
- `'centered'` — Returns the centered two-sided cross-spectrogram for a real or complex signal. `s` has `nfft` rows. If `nfft` is even, then `s` is computed over the interval $(-\pi, \pi]$ rad/sample. If `nfft` is odd, then `s` is computed over $(-\pi, \pi)$ rad/sample. If you specify `fs`, then the intervals are respectively $(-fs/2, fs/2]$ cycles/unit time and $(-fs/2, fs/2)$ cycles/unit time.

Data Types: char

spectrumtype — Cross power spectrum scaling

`'psd'` (default) | `'power'`

Cross power spectrum scaling, specified as `'psd'` or `'power'`.

- Omitting `spectrumtype`, or specifying `'psd'`, returns the cross power spectral density.
- Specifying `'power'` scales each estimate of the cross power spectral density by the resolution bandwidth, which depends on the equivalent noise bandwidth of the window and the segment duration. The result is an estimate of the power at each frequency.

Data Types: char

thresh — Threshold

`-Inf` (default) | real scalar

Threshold, specified as a real scalar expressed in decibels. `xspectrogram` sets to zero those elements of `s` such that $10 \log_{10}(s) \leq \text{thresh}$.

freqloc — Frequency display axis

`'xaxis'` (default) | `'yaxis'`

Frequency display axis, specified as `'xaxis'` or `'yaxis'`.

- `'xaxis'` — Displays frequency on the x -axis and time on the y -axis.
- `'yaxis'` — Displays frequency on the y -axis and time on the x -axis.

This argument is ignored if you call `xspectrogram` with output arguments.

Data Types: `char`

Output Arguments

s — Cross-spectrogram

matrix

Cross-spectrogram, returned as a matrix. Time increases across the columns of **s** and frequency increases down the rows, starting from zero.

- If the input signals **x** and **y** are of length N , then **s** has k columns, where:
 - $k = \lfloor (N - \text{noverlap}) / (\text{window} - \text{noverlap}) \rfloor$ if **window** is a scalar.
 - $k = \lfloor (N - \text{noverlap}) / (\text{length}(\text{window}) - \text{noverlap}) \rfloor$ if **window** is a vector.
- If the input signals are real and **nfft** is even, then **s** has $(\text{nfft}/2 + 1)$ rows.
- If the input signals are real and **nfft** is odd, then **s** has $(\text{nfft} + 1)/2$ rows.
- If the input signals are complex, then **s** has **nfft** rows.

Data Types: `double` | `single`

w — Normalized frequencies

vector

Normalized frequencies, returned as a vector. **w** has a length equal to the number of rows of **s**.

Data Types: `double` | `single`

t — Time instants

vector

Time instants, returned as a vector. The time values in **t** correspond to the midpoint of each segment specified using **window**.

Data Types: `double` | `single`

f — Cyclical frequencies

vector

Cyclical frequencies, returned as a vector. `f` has a length equal to the number of rows of `s`.

Data Types: `double` | `single`

c — Time-varying complex cross-spectrum

matrix

Time-varying complex cross-spectrum, returned as a matrix. The cross-spectrogram, `S`, is the magnitude of `c`.

Data Types: `double` | `single`

References

- [1] Oppenheim, Alan V., Ronald W. Schaffer, and John R. Buck. *Discrete-Time Signal Processing*. 2nd Ed. Upper Saddle River, NJ: Prentice Hall, 1999.
- [2] Mitra, Sanjit K. *Digital Signal Processing: A Computer-Based Approach*. 2nd Ed. New York: McGraw-Hill, 2001.

See Also

See Also

`cpsd` | `mscohere` | `spectrogram`

Introduced in R2017a

yulewalk

Recursive digital filter design

Syntax

`[b,a] = yulewalk(n,f,m)`

Description

`yulewalk` designs recursive IIR digital filters using a least-squares fit to a specified frequency response.

`[b,a] = yulewalk(n,f,m)` returns row vectors, **b** and **a**, containing the $n+1$ coefficients of the order n IIR filter whose frequency-magnitude characteristics approximately match those given in vectors **f** and **m**:

- **f** is a vector of frequency points, specified in the range between 0 and 1, where 1 corresponds to half the sample frequency (the Nyquist frequency). The first point of **f** must be 0 and the last point 1. All intermediate points must be in increasing order. Duplicate frequency points are allowed, corresponding to steps in the frequency response.
- **m** is a vector containing the desired magnitude response at the points specified in **f**.
- **f** and **m** must be the same length.
- `plot(f,m)` displays the filter shape.

The output filter coefficients are ordered in descending powers of z .

$$\frac{B(z)}{A(z)} = \frac{b(1) + b(2)z^{-1} + \dots + b(n+1)z^{-n}}{a(1) + a(2)z^{-1} + \dots + a(n+1)z^{-n}}$$

When specifying the frequency response, avoid excessively sharp transitions from passband to stopband. You may need to experiment with the slope of the transition region to get the best filter design.

Examples

Yule-Walker Design of Lowpass Filter

Design an 8th-order lowpass filter with normalized cutoff frequency 0.6. Plot its frequency response and overlay the response of the corresponding ideal filter.

```
f = [0 0.6 0.6 1];  
m = [1 1 0 0];  
[b,a] = yulewalk(8,f,m);  
[h,w] = freqz(b,a,128);  
  
plot(w/pi,abs(h),f,m,'--')  
xlabel 'Radian frequency (\omega/\pi)', ylabel Magnitude  
legend('Yule-Walker','Ideal'), legend boxoff
```

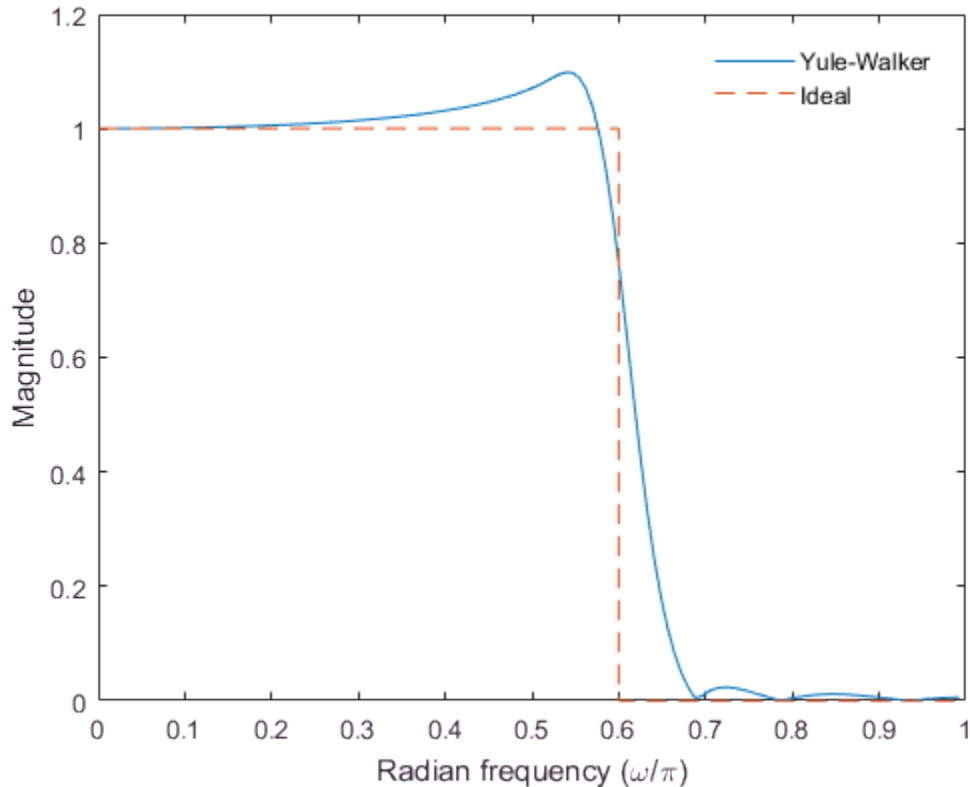

Algorithms

yulewalk performs a least-squares fit in the time domain. It computes the denominator coefficients using modified Yule-Walker equations, with correlation coefficients computed by inverse Fourier transformation of the specified frequency response. To compute the numerator, yulewalk takes the following steps:

- 1 Computes a numerator polynomial corresponding to an additive decomposition of the power frequency response.
- 2 Evaluates the complete frequency response corresponding to the numerator and denominator polynomials.

- 3 Uses a spectral factorization technique to obtain the impulse response of the filter.
- 4 Obtains the numerator polynomial by a least-squares fit to this impulse response.

References

- [1] Friedlander, B., and Boaz Porat. “The Modified Yule-Walker Method of ARMA Spectral Estimation.” *IEEE Transactions on Aerospace Electronic Systems*. Vol. AES-20, Number 2, 1984, pp.158–173.

Extended Capabilities

C/C++ Code Generation

Generate C and C++ code using MATLAB® Coder™.

Usage notes and limitations:

If specified, the order of recursion must be a constant. Expressions or variables are allowed if their values do not change.

See Also

`butter` | `cheby1` | `cheby2` | `ellip` | `fir2` | `firls` | `maxflat` | `firpm`

Introduced before R2006a

zerophase

Zero-phase response of digital filter

Syntax

```
[Hr,w] = zerophase(b,a)
[Hr,w] = zerophase(sos)
[Hr,w] = zerophase(d)
[Hr,w] = zerophase(...,nfft)
[Hr,w] = zerophase(...,nfft,'whole')
[Hr,w] = zerophase(...,w)
[Hr,f] = zerophase(...,f,fs)
[Hr,w,phi] = zerophase(...)
zerophase(...)
```

Description

[Hr,w] = zerophase(b,a) returns the zero-phase response Hr, and the frequency vector w (in radians/sample) at which Hr is computed, given a filter defined by numerator b and denominator a. For FIR filters where a=1, you can omit the value a from the command. The zero-phase response is evaluated at 512 equally spaced points on the upper half of the unit circle.

The zero-phase response, $H_r(\omega)$, is related to the frequency response, $H(e^{j\omega})$, by

$$H(e^{j\omega}) = H_r(\omega)e^{j\varphi(\omega)},$$

where $\varphi(\omega)$ is the continuous phase.

Note The zero-phase response is always real, but it is not the equivalent of the magnitude response. The former can be negative while the latter cannot be negative.

[Hr,w] = zerophase(sos) returns the zero-phase response for the second order sections matrix, sos. sos is a K -by-6 matrix, where the number of sections, K , must be

greater than or equal to 2. If the number of sections is less than 2, `zerophase` considers the input to be the numerator vector, `b`. Each row of `sos` corresponds to the coefficients of a second order (biquad) filter. The *i*th row of the `sos` matrix corresponds to `[bi(1) bi(2) bi(3) ai(1) ai(2) ai(3)]`.

`[Hr,w] = zerophase(d)` returns the zero-phase response for the digital filter, `d`. Use `designfilt` to generate `d` based on frequency-response specifications.

`[Hr,w] = zerophase(...,nfft)` returns the zero-phase response `Hr` and frequency vector `w` (radians/sample), using `nfft` frequency points on the upper half of the unit circle. For best results, set `nfft` to a value greater than the filter order.

`[Hr,w] = zerophase(...,nfft,'whole')` returns the zero-phase response `Hr` and frequency vector `w` (radians/sample), using `nfft` frequency points around the whole unit circle.

`[Hr,w] = zerophase(...,w)` returns the zero-phase response `Hr` and frequency vector `w` (radians/sample) at frequencies in vector `w`. The vector `w` must have at least two elements.

`[Hr,f] = zerophase(...,f,fs)` returns the zero-phase response `Hr` and frequency vector `f` (Hz), using the sampling frequency `fs` (in Hz), to determine the frequency vector `f` (in Hz) at which `Hr` is computed. The vector `f` must have at least two elements.

`[Hr,w,phi] = zerophase(...)` returns the zero-phase response `Hr`, frequency vector `w` (rad/sample), and the continuous phase component, `phi`. (Note that this quantity is not equivalent to the phase response of the filter when the zero-phase response is negative.)

`zerophase(...)` plots the zero-phase response versus frequency. If you input the filter coefficients or second order sections matrix, the current figure window is used. If you input a `digitalFilter`, the step response is displayed in `fvtool`.

Note: If the input to `zerophase` is single precision, the zero-phase response is calculated using single-precision arithmetic. The output, `Hr`, is single precision.

Examples

Zero-Phase Response of FIR filter

Use `designfilt` to design a 54th-order FIR filter with a normalized cutoff frequency of 0.3π rad/sample, a passband ripple of 0.7 dB, and a stopband attenuation of 42 dB. Use the method of constrained least squares. Display the zero-phase response.

```
Nf = 54;  
Fc = 0.3;  
Ap = 0.7;  
As = 42;
```

```
d = designfilt('lowpassfir','FilterOrder',Nf,'CutoffFrequency',Fc, ...  
              'PassbandRipple',Ap,'StopbandAttenuation',As,'DesignMethod','cls');  
zerophase(d)
```

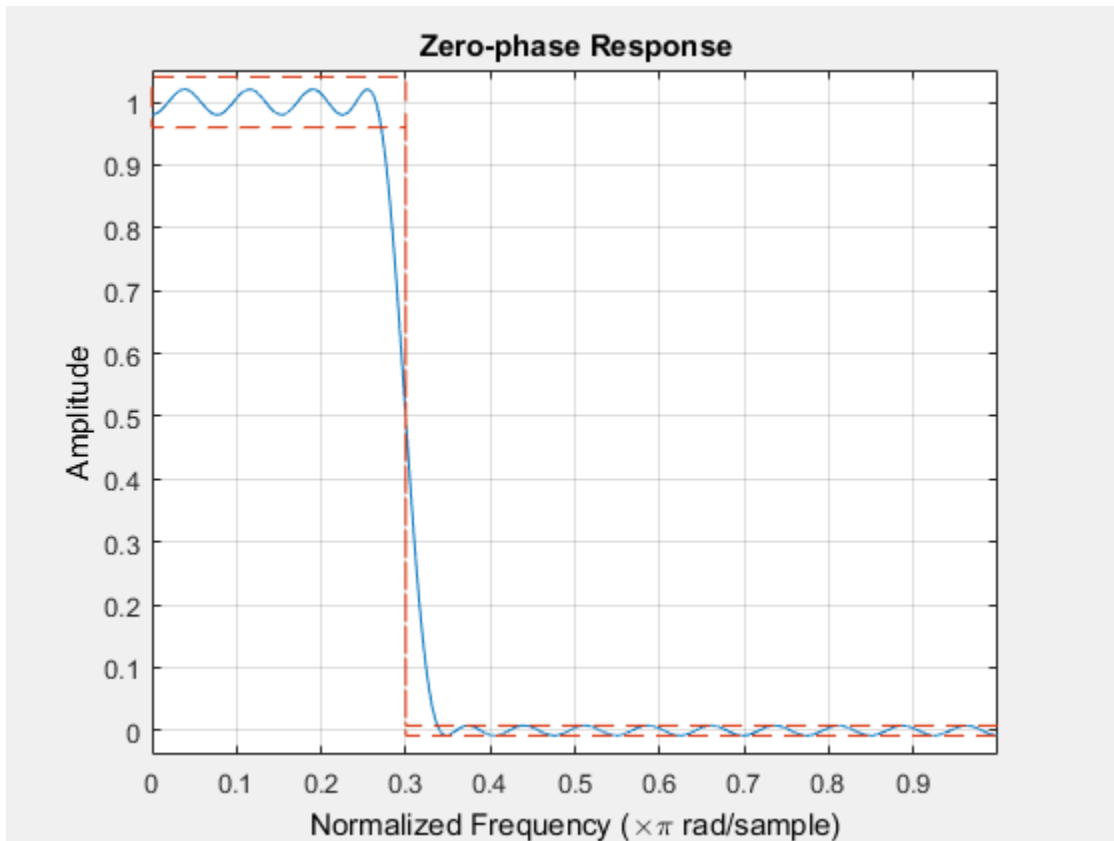

Design the same filter using `fircls1`, which uses linear units to measure the ripple and attenuation. Display the zero-phase response.

```
pAp = 10^(Ap/40);
Ap1 = (pAp-1)/(pAp+1);
pAs = 10^(As/20);
As1 = 1/pAs;

b = fircls1(Nf,Fc,Ap1,As1);
zerophase(b)
```

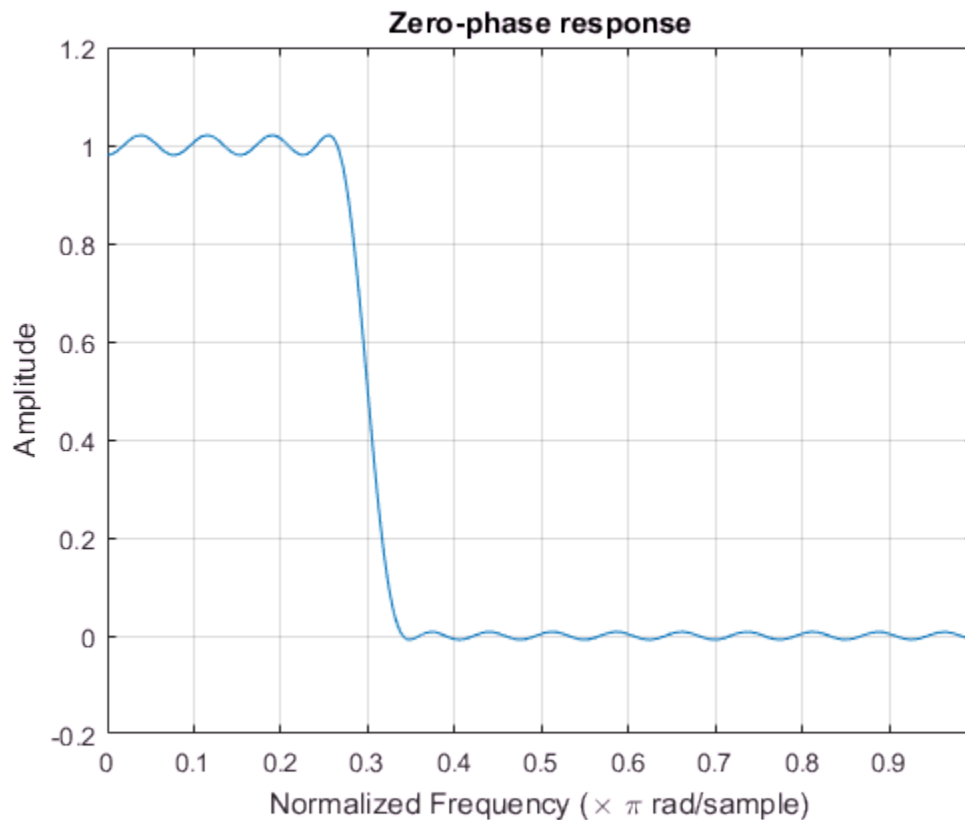
Zero-Phase Response of Elliptic Filter

Design a 10th-order elliptic lowpass IIR filter with a normalized passband frequency of 0.4π rad/sample, a passband ripple of 0.5 dB, and a stopband attenuation of 20 dB. Display the zero-phase response of the filter on 512 frequency points around the whole unit circle.

```
d = designfilt('lowpassiir','FilterOrder',10,'PassbandFrequency',0.4, ...
    'PassbandRipple',0.5,'StopbandAttenuation',20,'DesignMethod','ellip');
zerophase(d,512,'whole')
```

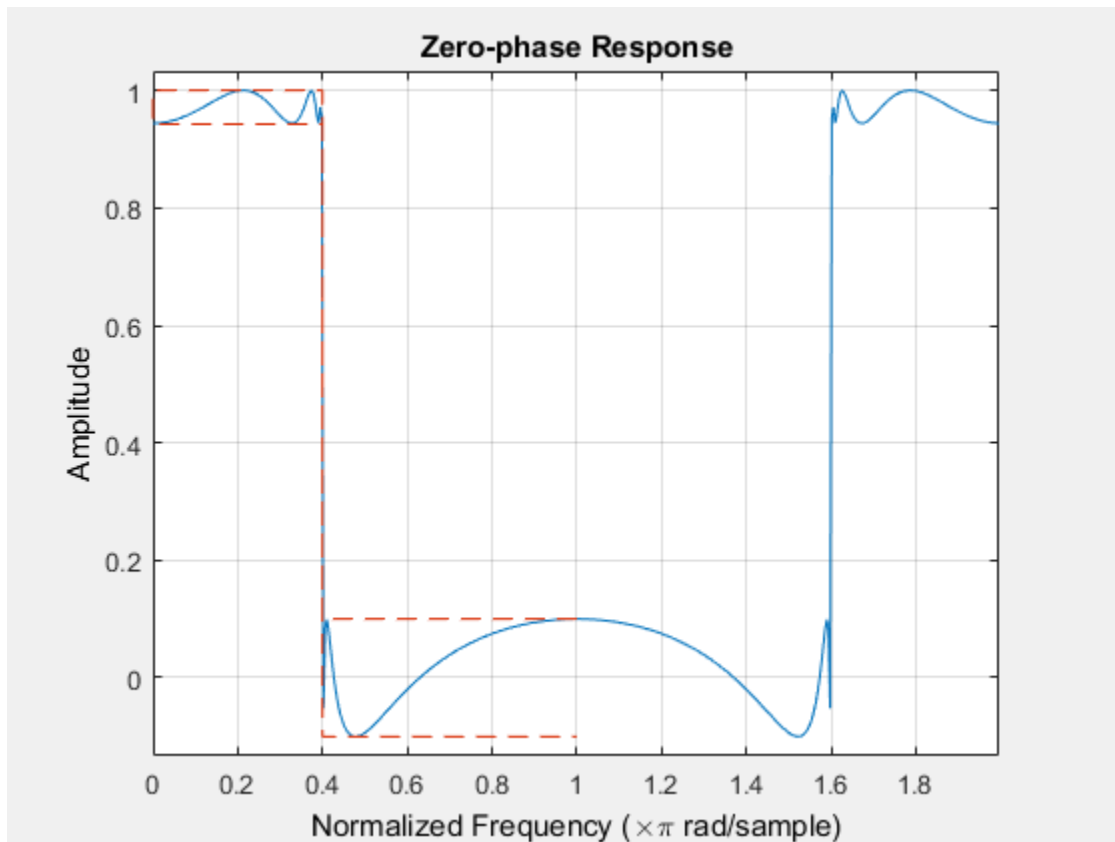

Create the same filter using `ellip`. Plot its zero-phase response.

```
[b,a] = ellip(10,0.5,20,0.4);  
zerophase(b,a,512, 'whole')
```

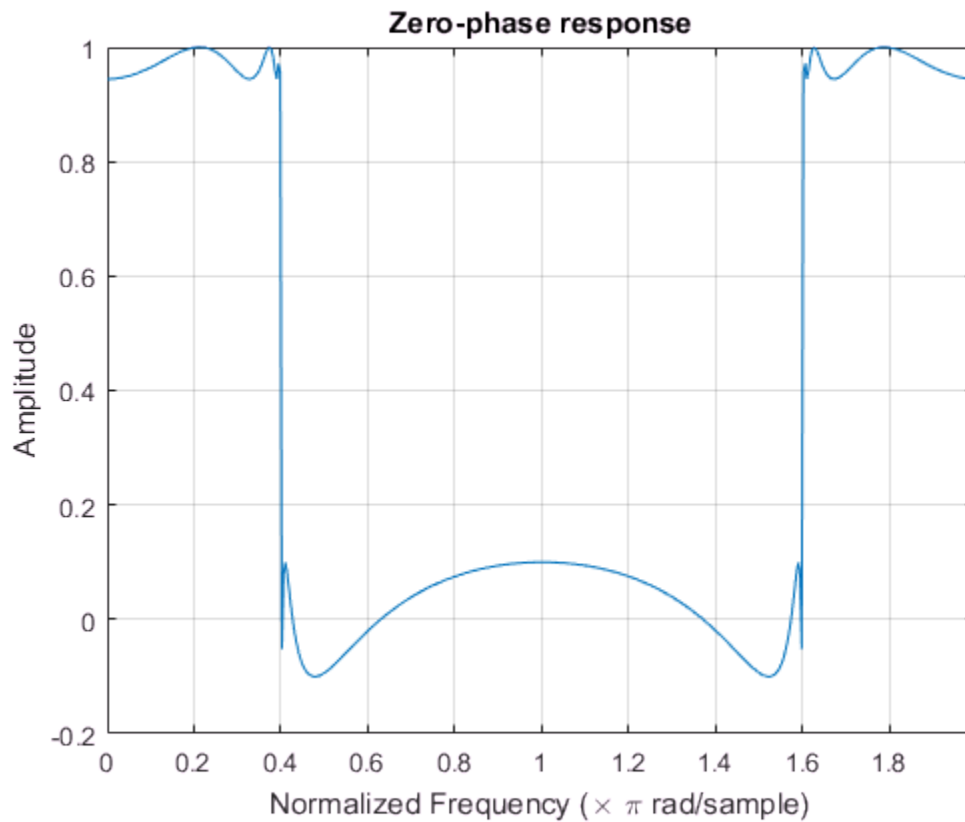

See Also

`designfilt` | `digitalFilter` | `freqs` | `freqz` | `fvtool` | `grpdelay` | `invfreqz` | `phasedelay` | `phasez`

Introduced before R2006a

zp2sos

Convert zero-pole-gain filter parameters to second-order sections form

Syntax

```
[sos,g] = zp2sos(z,p,k)
[sos,g] = zp2sos(z,p,k,'order')
[sos,g] = zp2sos(z,p,k,'order','scale')
[sos,g] = zp2sos(z,p,k,'order','scale',zeroflag)
sos = zp2sos(...)
```

Description

`zp2sos` converts a discrete-time zero-pole-gain representation of a given digital filter to an equivalent second-order section representation.

`[sos,g] = zp2sos(z,p,k)` creates a matrix `sos` in second-order section form with gain `g` equivalent to the discrete-time zero-pole-gain filter represented by input arguments `z`, `p`, and `k`. Vectors `z` and `p` contain the zeros and poles of the filter's transfer function $H(z)$, not necessarily in any particular order.

$$H(z) = k \frac{(z - z_1)(z - z_2) \cdots (z - z_n)}{(z - p_1)(z - p_2) \cdots (z - p_m)}$$

where n and m are the lengths of `z` and `p`, respectively, and `k` is a scalar gain. The zeros and poles must be real or complex conjugate pairs. `sos` is an L -by-6 matrix

$$\text{sos} = \begin{bmatrix} b_{01} & b_{11} & b_{21} & 1 & a_{11} & a_{21} \\ b_{02} & b_{12} & b_{22} & 1 & a_{12} & a_{22} \\ \vdots & \vdots & \vdots & \vdots & \vdots & \vdots \\ b_{0L} & b_{1L} & b_{2L} & 1 & a_{1L} & a_{2L} \end{bmatrix}$$

whose rows contain the numerator and denominator coefficients b_{ik} and a_{ik} of the second-order sections of $H(z)$.

$$H(z) = g \prod_{k=1}^L H_k(z) = g \prod_{k=1}^L \frac{b_{0k} + b_{1k}z^{-1} + b_{2k}z^{-2}}{1 + a_{1k}z^{-1} + a_{2k}z^{-2}}$$

The number L of rows of the matrix `sos` is the closest integer greater than or equal to the maximum of $n/2$ and $m/2$.

`[sos,g] = zp2sos(z,p,k,'order')` specifies the order of the rows in `sos`, where `'order'` is

- `'down'`, to order the sections so the first row of `sos` contains the poles closest to the unit circle
- `'up'`, to order the sections so the first row of `sos` contains the poles farthest from the unit circle (default)

`[sos,g] = zp2sos(z,p,k,'order','scale')` specifies the desired scaling of the gain and the numerator coefficients of all second-order sections, where `'scale'` is

- `'none'`, to apply no scaling (default)
- `'inf'`, to apply infinity-norm scaling
- `'two'`, to apply 2-norm scaling

Using infinity-norm scaling in conjunction with `up`-ordering minimizes the probability of overflow in the realization. Using 2-norm scaling in conjunction with `down`-ordering minimizes the peak round-off noise.

Note Infinity-norm and 2-norm scaling are appropriate only for direct-form II implementations.

`[sos,g] = zp2sos(z,p,k,'order','scale',zeroflag)` specifies whether to keep together real zeros that are the negatives of each other instead of ordering them according to proximity to poles. Setting `zeroflag` to `true` keeps the zeros together and results in a numerator with a middle coefficient equal to zero. The default for `zeroflag` is `false`.

`sos = zp2sos(...)` embeds the overall system gain, g , in the first section, $H_1(z)$, so that

$$H(z) = \prod_{k=1}^L H_k(z)$$

Note Embedding the gain in the first section when scaling a direct-form II structure is not recommended and may result in erratic scaling. To avoid embedding the gain, use `ss2sos` with two outputs.

Examples

Second-Order Sections from Zero-Pole-Gain Parameters

Design a 5th-order Butterworth lowpass filter using the function `butter` with output expressed in zero-pole-gain form. Specify the cutoff frequency to be one-fifth of the Nyquist frequency. Convert the result to second-order sections. Visualize the magnitude response.

```
[z,p,k] = butter(5,0.2);  
sos = zp2sos(z,p,k)
```

```
sos =
```

```
    0.0013    0.0013         0    1.0000   -0.5095         0  
    1.0000    2.0000    1.0000    1.0000   -1.0966    0.3554  
    1.0000    2.0000    1.0000    1.0000   -1.3693    0.6926
```

```
fvtool(sos)
```

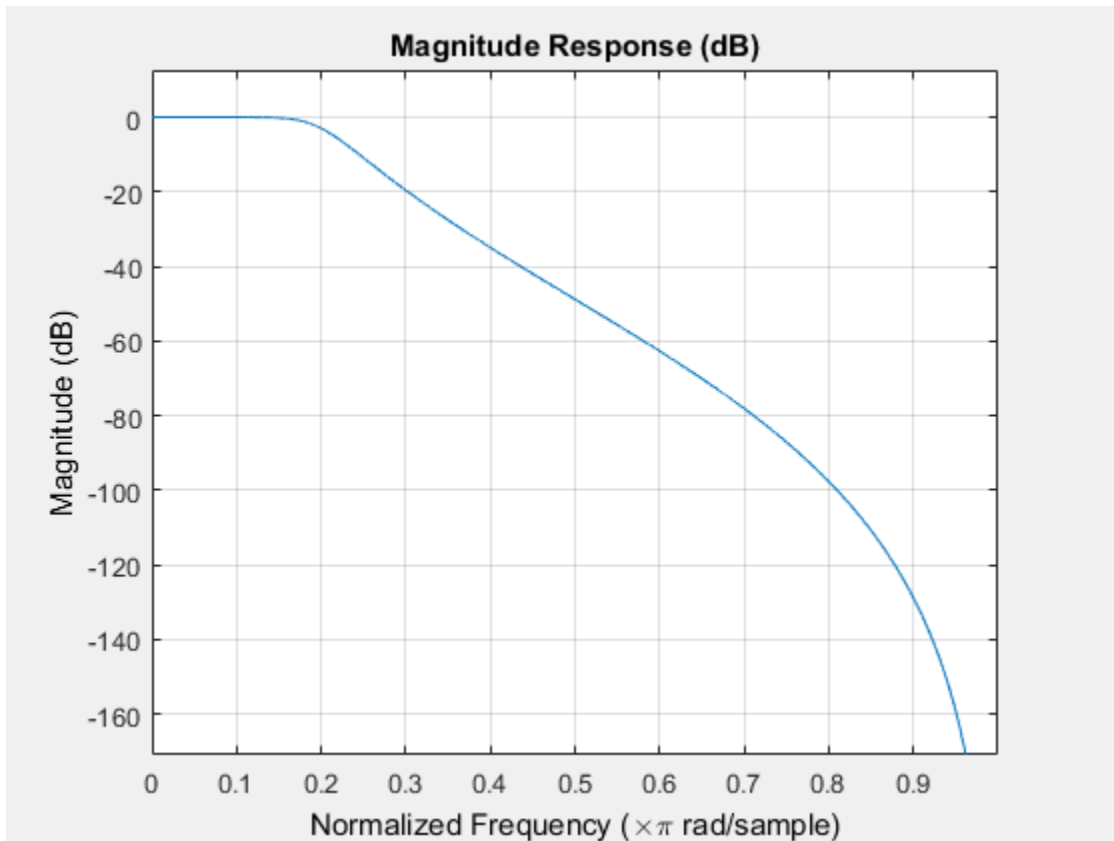

Algorithms

zp2sos uses a four-step algorithm to determine the second-order section representation for an input zero-pole-gain system:

- 1 It groups the zeros and poles into complex conjugate pairs using the `cplxpair` function.
- 2 It forms the second-order section by matching the pole and zero pairs according to the following rules:
 - a Match the poles closest to the unit circle with the zeros closest to those poles.

- b** Match the poles next closest to the unit circle with the zeros closest to those poles.
- c** Continue until all of the poles and zeros are matched.

`zp2sos` groups real poles into sections with the real poles closest to them in absolute value. The same rule holds for real zeros.

- 3** It orders the sections according to the proximity of the pole pairs to the unit circle. `zp2sos` normally orders the sections with poles closest to the unit circle last in the cascade. You can tell `zp2sos` to order the sections in the reverse order by specifying the `down` flag.
- 4** `zp2sos` scales the sections by the norm specified in the '`scale`' argument. For arbitrary $H(\omega)$, the scaling is defined by

$$\|H\|_p = \left[\frac{1}{2\pi} \int_0^{2\pi} |H(\omega)|^p d\omega \right]^{1/p}$$

where p can be either ∞ or 2. See the references for details on the scaling. This scaling is an attempt to minimize overflow or peak round-off noise in fixed point filter implementations.

References

- [1] Jackson, L. B. *Digital Filters and Signal Processing*, 3rd Ed. Boston: Kluwer Academic Publishers, 1996, chap.11.
- [2] Mitra, S. K. *Digital Signal Processing: A Computer-Based Approach*. New York: McGraw-Hill, 1998, chap.9.
- [3] Vaidyanathan, P. P. "Robust Digital Filter Structures." *Handbook for Digital Signal Processing* (S. K. Mitra and J. F. Kaiser, eds.). New York: John Wiley & Sons, 1993, chap.7.

See Also

`cplxpair` | `sos2zp` | `ss2sos` | `tf2sos` | `zp2ss` | `zp2tf` | `filternorm`

Introduced before R2006a

zp2ss

Convert zero-pole-gain filter parameters to state-space form

Syntax

$[A, B, C, D] = \text{zp2ss}(z, p, k)$

Description

`zp2ss` converts a zero-pole-gain representation of a given system to an equivalent state-space representation.

$[A, B, C, D] = \text{zp2ss}(z, p, k)$ finds a single input, multiple output, state-space representation

$$\dot{x} = Ax + Bu$$

$$y = Cx + Du$$

given a system in factored transfer function form.

$$H(s) = \frac{Z(s)}{P(s)} = k \frac{(s - z_1)(s - z_2) \cdots (s - z_n)}{(s - p_1)(s - p_2) \cdots (s - p_n)}$$

Column vector p specifies the pole locations, and matrix z the zero locations with as many columns as there are outputs. The gains for each numerator transfer function are in vector k . The A , B , C , and D matrices are returned in controller canonical form.

`Inf` values may be used as place holders in z if some columns have fewer zeros than others.

Examples

State-Space Representation of Mass-Spring System

Generate the state-space representation of a damped mass-spring system that obeys the differential equation

$$w + 0.01\dot{w} + w = u(t).$$

The measurable quantity is the acceleration, $y = \ddot{w}$, and $u(t)$ is the driving force. In Laplace space, the system is represented by

$$Y(s) = \frac{s^2 U(s)}{s^2 + 0.01s + 1}.$$

The system has unit gain, a double zero at $s = 0$, and two complex-conjugate poles.

```
z = [0 0];
p = roots([1 0.01 1])
```

```
p =
-0.0050 + 1.0000i
-0.0050 - 1.0000i
```

```
k = 1;
```

Use `zp2ss` to find the state-space matrices.

```
[A,B,C,D] = zp2ss(z,p,k)
```

```
A =
-0.0100 -1.0000
1.0000 0
```

```
B =
1
0
```

```
C =
-0.0100 -1.0000
```

```
D = 1
```

Algorithms

zp2ss, for single-input systems, groups complex pairs together into two-by-two blocks down the diagonal of the A matrix. This requires the zeros and poles to be real or complex conjugate pairs.

See Also

sos2ss | ss2zp | tf2ss | zp2sos | zp2tf

Introduced before R2006a

zp2tf

Convert zero-pole-gain filter parameters to transfer function form

Syntax

`[b,a] = zp2tf(z,p,k)`

Description

`zp2tf` forms transfer function polynomials from the zeros, poles, and gains of a system in factored form.

`[b,a] = zp2tf(z,p,k)` finds a rational transfer function

$$\frac{B(s)}{A(s)} = \frac{b_1 s^{(n-1)} + \dots + b_{(n-1)} s + b_n}{a_1 s^{(m-1)} + \dots + a_{(m-1)} s + a_m}$$

given a system in factored transfer function form

$$H(s) = \frac{Z(s)}{P(s)} = k \frac{(s - z_1)(s - z_2) \dots (s - z_m)}{(s - p_1)(s - p_2) \dots (s - p_n)}$$

Column vector \mathbf{p} specifies the pole locations, and matrix \mathbf{z} specifies the zero locations, with as many columns as there are outputs. The gains for each numerator transfer function are in vector \mathbf{k} . The zeros and poles must be real or come in complex conjugate pairs. The polynomial denominator coefficients are returned in row vector \mathbf{a} and the polynomial numerator coefficients are returned in matrix \mathbf{b} , which has as many rows as there are columns of \mathbf{z} .

Inf values can be used as place holders in \mathbf{z} if some columns have fewer zeros than others.

Examples

Transfer Function of Mass-Spring System

Compute the transfer function of a damped mass-spring system that obeys the differential equation

$$w + 0.01\dot{w} + w = u(t).$$

The measurable quantity is the acceleration, $y = \ddot{w}$, and $u(t)$ is the driving force. In Laplace space, the system is represented by

$$Y(s) = \frac{s^2 U(s)}{s^2 + 0.01s + 1}.$$

The system has unit gain, a double zero at $s = 0$, and two complex-conjugate poles.

$$z = [0 \ 0]';$$

$$p = \text{roots}([1 \ 0.01 \ 1])$$

$$p =$$

$$-0.0050 + 1.0000i$$

$$-0.0050 - 1.0000i$$

$$k = 1;$$

Use `zp2tf` to find the transfer function.

$$[b, a] = \text{zp2tf}(z, p, k)$$

$$b =$$

$$1 \quad 0 \quad 0$$

$$a =$$

$$1.0000 \quad 0.0100 \quad 1.0000$$

Algorithms

The system is converted to transfer function form using `poly` with `p` and the columns of `z`.

Extended Capabilities

C/C++ Code Generation

Generate C and C++ code using MATLAB® Coder™.

See Also

[sos2tf](#) | [ss2tf](#) | [tf2zp](#) | [tf2zpk](#) | [zp2sos](#) | [zp2ss](#)

Introduced before R2006a

zpk

Convert digital filter to zero-pole-gain representation

Syntax

```
[z,p,k] = zpk(d)
```

Description

`[z,p,k] = zpk(d)` returns the zeros, poles, and gain corresponding to the digital filter, `d`, in vectors `z` and `p`, and scalar `k`, respectively.

Examples

Highpass Filter in Zero-Pole-Gain Form

Design a highpass FIR filter of order 8 with passband frequency 75 kHz and passband ripple 0.2 dB. Specify a sample rate of 200 kHz. Find the zeros, poles, and gain of the filter.

```
hpFilt = designfilt('highpassiir','FilterOrder',8, ...  
                  'PassbandFrequency',75e3,'PassbandRipple',0.2, ...  
                  'SampleRate',200e3);
```

```
[z,p,k] = zpk(hpFilt)
```

```
z =
```

```
1  
1  
1  
1  
1  
1  
1  
1  
1
```

```
p =
```



```
-0.6707 + 0.6896i  
-0.6707 - 0.6896i  
-0.6873 + 0.5670i  
-0.6873 - 0.5670i  
-0.7399 + 0.3792i  
-0.7399 - 0.3792i  
-0.7839 + 0.1344i  
-0.7839 - 0.1344i
```

```
k = 1.2797e-05
```

Input Arguments

d — Digital filter

digitalFilter object

Digital filter, specified as a digitalFilter object. Use `designfilt` to generate a digital filter based on frequency-response specifications.

Example: `d = designfilt('lowpassiir','FilterOrder',3,'HalfPowerFrequency',0.5)` specifies a third-order Butterworth filter with normalized 3-dB frequency 0.5π rad/sample.

Output Arguments

z — Zeros

column vector

Zeros of the filter, returned as a column vector.

Data Types: double

p — Poles

column vector

Poles of the filter, returned as a column vector.

Data Types: double

k — Gain

real scalar

Gain of the filter, returned as a real scalar.

Data Types: double

See Also

See Also

`designfilt` | `digitalFilter` | `ss` | `tf`

Introduced in R2014a

zplane

Zero-pole plot

Syntax

```
zplane(z,p)
zplane(b,a)
zplane(d)
[hz, hp, ht] = zplane(z,p)
```

Description

This function displays the poles and zeros of discrete-time systems.

`zplane(z,p)` plots the zeros specified in column vector `z` and the poles specified in column vector `p` in the current figure window. The symbol 'o' represents a zero and the symbol 'x' represents a pole. The plot includes the unit circle for reference. If `z` and `p` are arrays, `zplane` plots the poles and zeros in the columns of `z` and `p` in different colors.

`zplane(b,a)` where `b` and `a` are row vectors, first uses `roots` to find the zeros and poles of the transfer function represented by numerator coefficients `b` and denominator coefficients `a`. The transfer function is defined in terms of z^{-1} :

$$H(z) = \frac{B(z)}{A(z)} = \frac{b(1) + b(2)z^{-1} + \dots + b(n+1)z^{-n}}{a(1) + a(2)z^{-1} + \dots + a(m+1)z^{-m}}$$

`zplane(d)` finds the zeros and poles of the transfer function represented by the digital filter, `d`. Use `designfilt` to generate `d` based on frequency-response specifications. The pole-zero plot is displayed in `fvtool`.

`[hz, hp, ht] = zplane(z,p)` returns vectors of handles to the zero lines, `hz`, and the pole lines, `hp`. `ht` is a vector of handles to the axes/unit circle line and to text objects, which are present when there are multiple zeros or poles. If there are no zeros or no poles, `hz` or `hp` is the empty matrix `[]`.

Examples

Poles and Zeros of an Elliptic Lowpass Filter

For data sampled at 1000 Hz, plot the poles and zeros of a 4th-order elliptic lowpass digital filter with cutoff frequency 200 Hz, 3 dB of ripple in the passband, and 30 dB of attenuation in the stopband.

```
[z,p,k] = ellip(4,3,30,200/500);  
zplane(z,p)  
grid  
title('4th-Order Elliptic Lowpass Digital Filter')
```

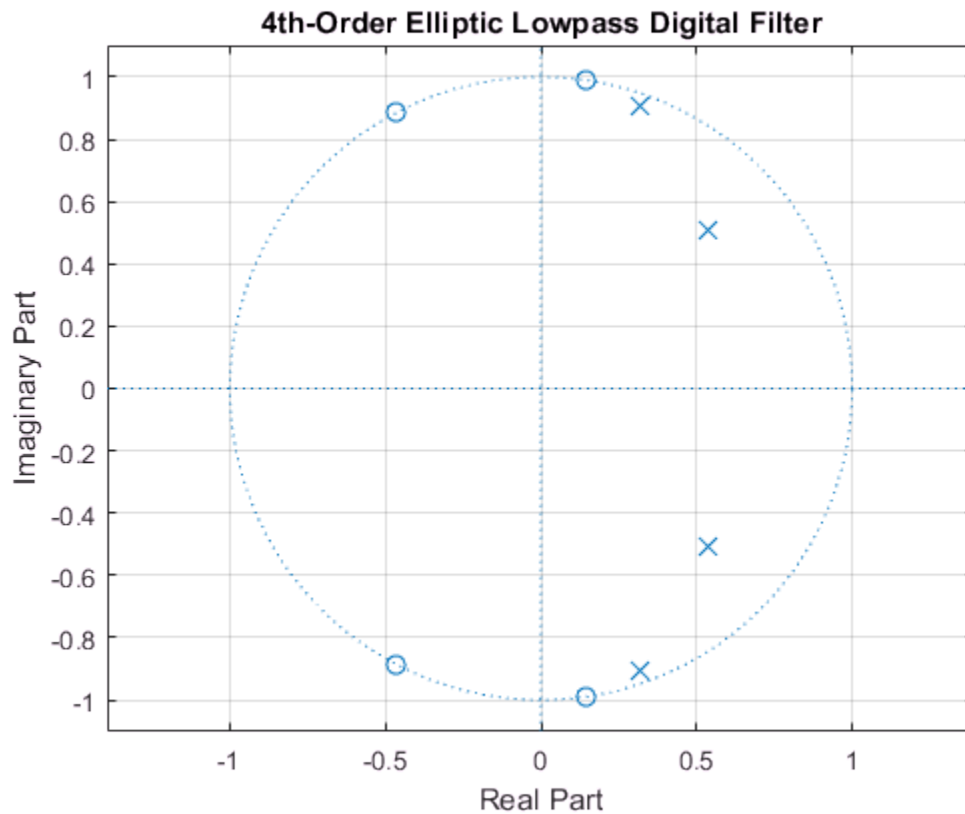

Create the same filter using `designfilt`. Use `fvttool` to plot its poles and zeros.

```
d = designfilt('lowpassiir', 'FilterOrder', 4, 'PassbandFrequency', 200, ...  
              'PassbandRipple', 3, 'StopbandAttenuation', 30, ...  
              'DesignMethod', 'ellip', 'SampleRate', 1000);  
zplane(d)
```

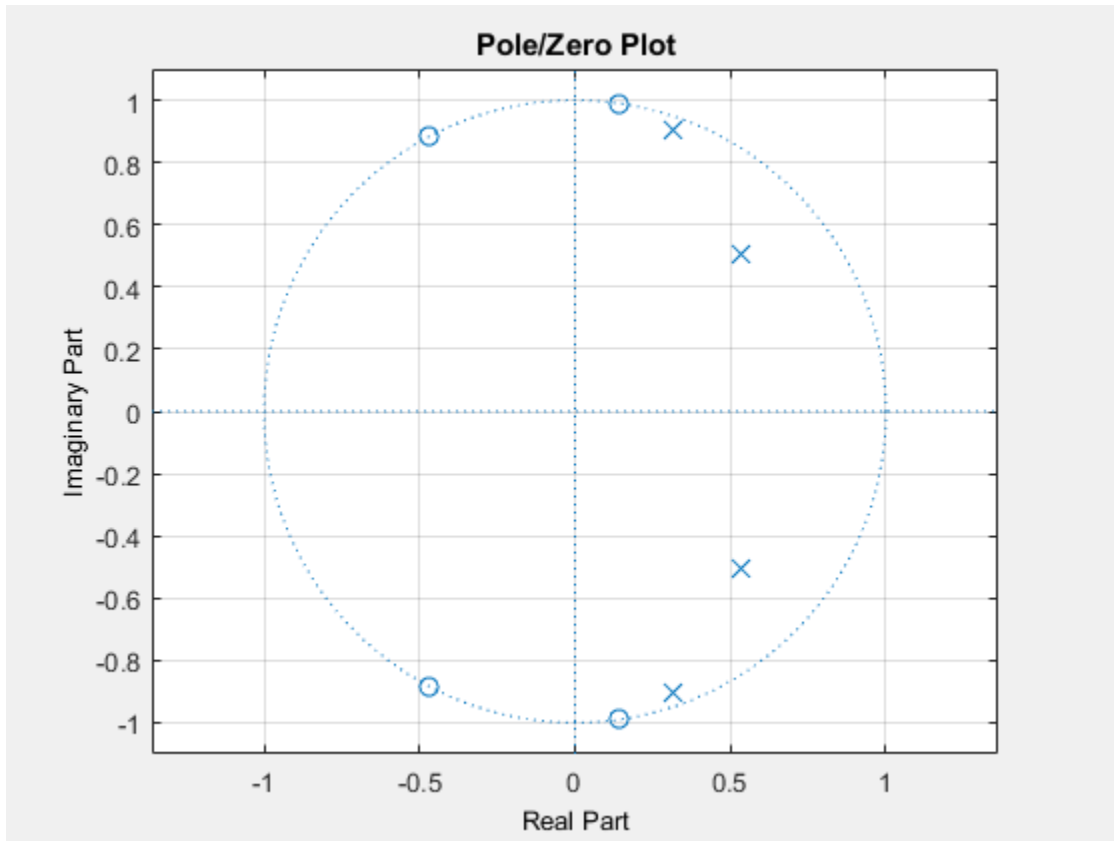

- “Speaker Crossover Filters”

Tips

- You can override the automatic scaling of `zplane` using `axis([xmin xmax ymin ymax])`

after calling `zplane`. This is useful in cases where one or more of the zeros or poles have such a large magnitude that the others are grouped tightly around the origin and are hard to distinguish.

See Also

See Also

`designfilt` | `digitalFilter` | `freqz`

Topics

“Speaker Crossover Filters”

Introduced before R2006a